



Organisation intergouvernementale pour les transports internationaux ferroviaires  
Zwischenstaatliche Organisation für den internationalen Eisenbahnverkehr  
Intergovernmental Organisation for International Carriage by Rail

---

**Commission d'experts techniques  
Fachausschuss für technische Fragen  
Committee of Technical Experts**

**TECH-20005**

**17.06.2020**

Original: EN

---

Proposal for modification of the Uniform Technical Prescription concerning freight wagons (UTP WAG)

## **1. INTRODUCTION**

In accordance with Article 20 § 1 b) of COTIF and Article 6 of APTU (Appendix F of COTIF), the Committee of Technical Experts is competent to take decisions about the adoption of a Uniform Technical Prescription (UTP) or a provision amending a UTP.

This proposal to modify the UTP applicable to the rolling stock subsystem: freight wagon (UTP WAG), as last amended on 1 December 2016, has been developed in accordance with COTIF, as last amended on 1 March 2019, in particular with Article 8 of APTU.

## **2. CONTEXT AND SUBSTANCE OF THE PROPOSAL**

The UTP WAG has been revised and updated several times since it was first adopted in 2012, with the purpose of keeping it aligned with legal developments and developments in the industry.

The proposed modifications include:

- New requirements concerning automatic variable gauge running gear.
- Provisions concerning the handling and maintenance of safety critical components.
- Reference to route compatibility checks in which railway undertakings check all relevant parameters of freight wagons to ensure their compatibility with the route on which they will be used.
- Update of the procedure in relation to the competences of the Committee of Technical Experts and the Secretary General concerning the use of 'innovative solutions' in freight wagons.
- New rules applicable when existing wagons or existing types of wagons are modified, including rules on whether or not the changes require a new admission to international traffic.
- Update of references to standards and other legal texts, including new European Union legislation.
- Deletion of Appendices of which the substance has become available in a standard.

The proposed modifications also include editorial and structural changes where, for example, all transitional provisions related to interoperability constituents have been clarified and moved from chapter 0 to 5, and all transitional provisions related to the subsystem have been moved from chapter 0 to 7.1.1.

The modifications are set out in the Annex in the form of track changes.

## **3. PREPARATORY WORK**

The proposed modifications were discussed at the 38<sup>th</sup> and 39<sup>th</sup> sessions of the Working Group Technology.

## **4. JUSTIFICATION FOR THE AMENDMENTS**

In order to ensure the continued mutual recognition of vehicles authorised in accordance with European Union law and vehicles admitted to international operation in accordance with Article 3a of ATMF, the European Union TSIs and COTIF UTPs must remain aligned.

On 16 May 2019, the European Union adopted a new implementing Regulation (EU) 2019/776, which modified the Technical Specifications for Interoperability concerning freight wagons (WAG TSI).

The proposed modifications will ensure continued full equivalence in the meaning of ATMF between the European Union and COTIF provisions.

### **PROPOSAL FOR DECISION**

1. In accordance with Article 20 § 1 b) and Article 35 of COTIF and Article 6 of APTU, the Committee of Technical Experts adopts the Uniform Technical Prescription for subsystem rolling stock: freight wagon, as set out in the Annex.
2. This UTP shall replace UTP WAG as last amended on 1 December 2016; the old version shall therefore be repealed at the moment of entry into force of the new version.



Organisation intergouvernementale pour les  
transports internationaux ferroviaires

Zwischenstaatliche Organisation für den  
internationalen Eisenbahnverkehr

Intergovernmental Organisation for  
International Carriage by Rail

# **Uniform Technical Prescription**

Applicable to the Rolling  
Stock subsystem:

**FREIGHT WAGONS**

**UTP WAG**

Applicable from

 <b>OTIF</b>	<b>ROLLING STOCK FREIGHT WAGONS</b>		<b>UTP WAG</b> Page 2 of 151
	Status: <b>PROPOSAL</b>	TECH-20005 Annex	Original: EN

APTU Uniform Rules (Appendix F to COTIF 1999)

## Uniform Technical Prescriptions (UTP) applicable to the Rolling Stock subsystem:

### FREIGHT WAGONS - (UTP WAG)

This UTP has been developed in accordance with COTIF, as amended by OTIF's Revision Committee in February 2018 and which entered into force on 1 March 2019, in particular with Article 8 of APTU (Appendix F to COTIF). For definitions, see also Article 2 of APTU and Article 2 of ATMF (Appendix G to COTIF).

~~These regulations have been developed in accordance with the provisions of APTU, in particular Article 8, in the version as amended by the OTIF Revision Committee in 2009 and 2014, which entered into force on 1 July 2015. For definitions and terms, see also Article 2 of the version of ATMF (Appendix G) and Article 2 of the version of APTU (Appendix F) in force since 1 July 2015, both Appendices to the 1999 version of the COTIF Convention. Footnotes include both explanatory information (which is not part of the regulations), and references to other regulations.~~

*Explanatory note:*

~~The texts of this UTP which appear across two columns are identical to corresponding texts of the European Union regulations. Texts which appear in two columns differ; the left hand column contains the UTP regulations, the right hand column shows the text in the corresponding EU regulations. The text in the right hand column is for information only and is not part of the OTIF regulations. Texts in the right hand column which are not quoted from the WAG TSI, but from other EU regulations are in italics. Appendices H to O do not appear in the WAG TSI.~~

#### 0. EQUIVALENCE ~~AND TRANSITIONAL PROVISIONS~~

Following their adoption by the Committee of Technical Experts, the OTIF regulations included in this document are declared equivalent to the corresponding EU regulations within the meaning of Article 13 § 4 of APTU and Article 3a of ATMF, in particular with:

- The TSI for freight wagons Commission Regulation (EU) No 321/2013 of 13 March 2013 as [last](#) amended by Commission [Implementing Regulations](#) (EU) No ~~2019/776 of 16 May 2019~~ ~~1236/2013 of 2 December 2013 and (EU) 2015/924 of 8 June 2015~~, hereinafter referred to as the WAG TSI.

The objectives and scope of COTIF and the EU law concerning railways are not identical and it has therefore been necessary to use different terminology for concepts that have a similar, but not identical meaning. The following table lists the terms

 <b>OTIF</b>	<b>ROLLING STOCK</b> <b>FREIGHT WAGONS</b>		<b>UTP WAG</b> Page 3 of 151
	Status: <b>PROPOSAL</b>		TECH-20005 Annex

used in this UTP and the corresponding terms used in the WAG TSI:

<u>This UTP</u>	<u>WAG TSI</u>
<u>Uniform Technical Prescriptions (UTP)</u>	<u>Technical Specification of Interoperability (TSI)</u>
<u>Admission to international traffic</u>	<u>Authorisation for placing on the market</u>
<u>elements of construction</u>	<u>interoperability constituents</u>
<u>The declaration of conformity</u>	<u>The EC declaration of conformity</u>
<u>Type examination</u>	<u>EC type examination</u>
<u>type or design examination certificate</u>	<u>EC type or design examination certificate</u>
<u>UTP verification procedure</u>	<u>EC verification procedure</u>
<u>UTP declaration of verification</u>	<u>EC declaration of verification</u>
<u>UTP Certificate of verification</u>	<u>EC Certificate of verification</u>
<u>Contracting State</u>	<u>Member State</u>
<u>Assessing Entity</u>	<u>Notified Body</u>

Where provisions in this UTP and the WAG TSI differ in substance, the respective texts are in a 2-column format. The left-hand column and the full width texts show the UTP provisions (OTIF regulations) and the right-hand column shows the European Union TSI texts. Texts in the right-hand column are strictly for information only. For EU law, consult the Official Journal of the European Union.

Where differences between texts of this UTP and the European Union WAG TSI are either editorial, or not substantive, or concern the list of terms quoted above, the WAG TSI texts are not generally reproduced. The TSI texts may however be reproduced to improve clarity and readability.

 <b>OTIF</b>	<b>ROLLING STOCK FREIGHT WAGONS</b>		<b>UTP WAG</b> Page 4 of 151	
	Status: <b>PROPOSAL</b>		TECH-20005 Annex	Original: EN

## 1. INTRODUCTION

A Uniform Technical Prescription (UTP) is a set of rules relating to a subsystem or a part of it, as defined in APTU ~~Appendix F to the Convention~~, in order to further the aims as laid down in Article 3 of APTU and:

A Technical Specification for Interoperability (TSI) is a specification that covers a subsystem (or part of it) as described in Article 2(~~1~~) of Directive ~~(EU) 2016/797~~~~2008/57/EC~~ in order:

- to ensure the interoperability of the rail system and
- to meet the essential requirements.

### 1.1. Technical scope

This UTP shall apply to freight wagons as defined in Section 2 of the present UTP which meet the criteria set out in the present section.

*(<sup>1</sup>) The TSI shall apply to the ‘rolling stock – freight wagons’ subsystem as described in point 2.7 of Annex II to Directive ~~(EU) 2016/797~~2008/57/EC.*

This UTP shall apply to freight wagons with a maximum operating speed lower than or equal to 160 km/h and a maximum axle load lower than or equal to 25 t.

*The TSI shall apply to freight wagons with a maximum operating speed lower than or equal to 160 km/h and a maximum axle load lower than or equal to 25 t.*

This UTP shall apply to freight wagons which are intended to be operated on one or more of the following nominal track gauges: 1435 mm, 1524 mm, 1600 mm, and 1668 mm.

*The TSI shall apply to freight wagons which are intended to be operated on one or more of the following nominal track gauges: 1435 mm, 1524 mm, 1600 mm, and 1668 mm. The TSI shall not apply to freight wagons operating mainly on the 1520 mm track gauge, which may occasionally be operated on 1524 mm track gauge.*

This UTP shall not apply to freight wagons operating mainly on the 1520 mm track gauge, which may occasionally be operated on 1524 mm track gauge.

*(<sup>2</sup>) The TSI shall apply to all new freight wagon rolling stock of the European Union's rail system, taking into account Section 7 of the Annex.*

This UTP shall apply to all new freight wagons intended for use in international traffic, taking into account section 7 of this UTP.

*The TSI set out in the Annex shall also apply to existing freight wagon rolling stock:*

The present UTP shall also apply to existing freight wagon rolling stock

- (a) when it is renewed or upgraded in accordance with ATMF Article 10, or
- (b) with regard to specific provisions, such as the traceability of axles in point

*(a) when it is renewed ~~or~~ and upgraded in accordance with section 7.2.2 of the Annex to this Regulation<sup>3</sup> ~~Article 20 of Directive 2008/57/EC~~, or*

<sup>1</sup> Article 2 of Commission Regulation (EU) No 321/2013 enacting the WAG TSI as last amended by Commission Implementing Regulation (EU) 2019/776 of 16 May 2019

<sup>2</sup> Article 3 of Commission Regulation (EU) No 321/2013 enacting the WAG TSI as last amended by Commission Implementing Regulation (EU) 2019/776 of 16 May 2019

<sup>3</sup> Commission Regulation (EU) No 321/2013 enacting the WAG TSI as last amended by Commission Implementing Regulation (EU) 2019/776 of 16 May 2019

 <b>OTIF</b>	<b>ROLLING STOCK FREIGHT WAGONS</b>		<b>UTP WAG</b> Page 5 of 151	
Status: <b>PROPOSAL</b>		TECH-20005 Annex	Original: EN	Date: 17.06.2020

4.2.3.6.4 and the maintenance plan in point 4.5.3.

(b) with regard to specific provisions, such as the traceability of axles in point 4.2.3.6.4 and the maintenance plan in point 4.5.3.

## 1.2. Geographical scope

The geographical scope of this

UTP comprises all lines open to, or used for international traffic, taking into account the limitations concerning the track gauge set out in Section 1.1

TSI is the entire European Union's rail system as set out in the section 1 of Annex I to Directive (EU) 2016/797, taking into account the limitations concerning the track gauge set out in Article 2. ~~TSI is the network of the whole rail system, composed of:~~

- ~~• The trans-European conventional rail system network (TEN) as described in Annex I section 1.1 "Network" of Directive 2008/57/EC~~
- ~~• The trans-European high-speed rail system network (TEN) as described in Annex I section 2.1 "Network" of Directive 2008/57/EC~~
- ~~• Other parts of the network of the whole rail system, following the extension of scope as described in Annex I section 4 of Directive 2008/57/EC~~

~~and excludes the cases referred to in Article 1(3) of Directive 2008/57/EC.~~

## 1.3. Content of this document

In accordance with APTU – Appendix F to the Convention, this UTP:

In accordance with Article ~~5~~4(3) of Directive (EU) 2016/797~~2008/57/EC~~, this TSI:

- (a) indicates its intended scope (Chapter 2);
- (b) lays down essential requirements for the part of the rolling stock subsystem concerned and for its interfaces vis-à-vis other subsystems (Chapter 3);
- (c) establishes the functional and technical specifications to be met by the subsystem and its interfaces vis-à-vis other subsystems (Chapter 4).
- (d) determines the interoperability constituents

~~elements of construction~~

interoperability constituents

and interfaces which must be covered by European specifications, including European standards, which are necessary to achieve interoperability within the rail system (Chapter 5);



 <b>OTIF</b>	<b>ROLLING STOCK FREIGHT WAGONS</b>		<b>UTP WAG</b> Page 6 of 151	
	Status: <b>PROPOSAL</b>		TECH-20005 Annex	Original: EN

(e) states, in each case under consideration, which procedures are to be used in order to assess the conformity

with the provisions of the UTP (Chapter 6)

or the suitability for use of the interoperability constituents and the ‘EC’ verification of the subsystems (Chapter 6)

(f) indicates the strategy for implementing the [UTP \(Chapter 7\)](#)

~~UTP (Chapter 7)~~

~~TSIs (Chapter 7)~~

(g) indicates, for the staff concerned, the professional qualifications and health and safety conditions at work that are required for the operation and maintenance of the above subsystem, as well as for the implementation of this [UTP \(Chapter 4\)](#)

~~UTP (Chapter 4)~~

~~TSIs (Chapter 4)~~

## 2. SCOPE AND DEFINITION OF SUBSYSTEM

### 2.1. Scope

This UTP is applicable to wagons as defined in Article 2 (g) of APTU – Appendix F to the Convention, which are part of the subsystem Rolling Stock as defined in UTP GEN-B<sup>4</sup>, and which are intended to be used in international traffic.

This UTP is applicable to the subsystem “Operation and traffic management” with respect to the use of freight wagons within their limits and conditions of use and for the composition of trains with respect to freight wagons.

The UTP Marking is applicable to the assignment of the Unique Vehicle Number for the purpose of vehicle registration.

This TSI is applicable to “freight wagons including vehicles designed to carry lorries” as referred to in Annex I section ~~1.2 of to~~ Directive ~~2008/57/EC~~ [\(EU\) 2016/797](#) taking into account the limitations as set out in Article 2.

(<sup>5</sup>)

(<sup>6</sup>)

In the following this part of the subsystem rolling stock is called “freight wagon” and belongs to the subsystem “rolling stock”

as set out in the APTU Uniform Rules, UTP GEN-B. The other types of rolling stock listed in point 2.7 of UTP GEN-B are excluded from the scope of this UTP;

as set out in Annex II to Directive [\(EU\) 2016/797](#) ~~2008/57/EC~~.

-The other vehicles listed in [Section point 1.2](#) of Annex I to Directive [\(EU\) 2016/797](#)

<sup>4</sup> ~~A-94-01B/1-2012~~

<sup>5</sup> The EU requirements for the subsystem “Operation and traffic management” are set out in EU regulations, such as the OPE TSI.

<sup>6</sup> The European Vehicle Number is assigned according to the codes defined in [Appendix 6 of Commission Decision 2007/756/EC as last amended by Commission Implementing Decision \(EU\) 2018/1614, Appendix 6.](#)

 <b>OTIF</b>	<b>ROLLING STOCK</b> <b>FREIGHT WAGONS</b>		<b>UTP WAG</b> Page 7 of 151	
	Status: <b>PROPOSAL</b>		TECH-20005 Annex	Original: EN

~~2008/57/EC~~ are excluded from the scope of this TSI;

this is especially the case for:

(a) -mobile railway infrastructure construction and maintenance equipment;

~~(a)(b)~~ -and- vehicles designed to carry:

- motor vehicles with their passengers on board, or
- motor vehicles without passengers on board but intended to be integrated in passenger trains (car carriers);

(c) vehicles which

- increase their length in loaded configuration, and
- their payload itself is part of the vehicle structure.

Note: ~~s~~See also section 7.1 for particular cases.

## 2.2. Definitions

~~In the present~~

~~UTP~~

~~TSI~~

The following definitions are used:

- (a) A “unit” is the generic term used to name the rolling stock. It is subject to the application of this

UTP and therefore subject to assessment in accordance with UTP GEN-D<sup>7</sup>. TSI, and therefore subject to the EC verification procedure.

A unit can consist of:

- a “wagon” that can be operated separately, featuring an individual frame mounted on its own set of wheels, or
- a rake of permanently connected “elements”, those elements cannot be operated separately, or
- “separate rail bogies connected to compatible road vehicle(s)” the combination of which forms a rake of a rail compatible system.

- (b) A “train” is an operational formation consisting of several units.

- (c) The “design operating state” covers all conditions under which the unit is intended to operate and its technical boundaries.

This design operating state may go beyond the specifications of this UTP<sup>8</sup>

This design operating state may go beyond the specifications of this TSI in order that

<sup>7</sup> A 94-01D/3-2011

<sup>8</sup> This means that a rail transport undertaking may require the vehicle to have properties which go beyond the UTP requirements if these properties are necessary for this rail transport undertaking to operate a vehicle. Such requirements may relate to compatibility with the other rolling stock operated by this rail transport undertaking or may relate to how its operational activities are organised.

 <b>OTIF</b>	<b>ROLLING STOCK</b> <b>FREIGHT WAGONS</b>		<b>UTP WAG</b> Page 8 of 151	
	Status: <b>PROPOSAL</b>		TECH-20005 Annex	Original: EN

in order that units may be used together in a train on the network according to the operating rules applicable to, or applied by the rail transport undertaking.

Such operating rules include measures relating to train composition and measures designed to comply with the conditions and limits of use for the wagon and to ensure that the requirements as set out in section 4.4 are met during operation.

units may be used together in a train on the network under the safety management system of a railway undertaking.

### 3. ESSENTIAL REQUIREMENTS

UTP GEN-A<sup>9</sup> sets out the essential requirements that must be met by the subsystems and elements of construction. Table 1 indicates the basic parameters specified in the present UTP and their correlation to the essential requirements.

Article 43(1) of Directive [\(EU\) 2016/797/2008/57/EC](#) states, that the rail system its subsystems and their interoperability constituents shall meet the relevant essential requirements. The essential requirements are set out in general terms in Annex III of Directive [\(EU\) 2016/797/2008/57/EC](#). Table 1 indicates the basic parameters specified in this TSI and their correspondence to the essential requirements as explained in Annex III to Directive [\(EU\) 2016/797/2008/57/EC](#).

Table 1

Basic parameters and their correspondence to the essential requirements

point	basic parameter	essential requirements				
		safety	reliability & availability	health	environment protection	technical compatibility
4.2.2.1.1	End coupling	1.1.1, 1.1.3, 1.1.5, 2.4.1				
4.2.2.1.2	Inner coupling	1.1.1, 1.1.3, 2.4.1				
4.2.2.2	Strength of unit	1.1.1, 1.1.3, 2.4.1				
4.2.2.3	Integrity of the unit	1.1.1				
4.2.3.1	Gauging	1.1.1				2.4.3

<sup>9</sup>A-94-01A/1.2014

 <b>OTIF</b>	<b>ROLLING STOCK</b> <b>FREIGHT WAGONS</b>			<b>UTP WAG</b> Page 9 of 151
	Status: <b>PROPOSAL</b>		TECH-20005 Annex	Original: EN

4.2.3.2	Compatibility with load carrying capacity of lines	1.1.1				2.4.3
4.2.3.3	Compatibility with train detection systems	1.1.1				2.4.3
4.2.3.4	Axle bearing condition monitoring	1.1.1	1.2			2.4.3
4.2.3.5.1	Safety against derailment running on twisted track	1.1.1, 1.1.2, 2.4.1				2.4.3
4.2.3.5.2	Running dynamic behaviour	1.1.1 1.1.2				2.4.3
4.2.3.6.1	Structural design of bogie frame	1.1.1, 1.1.2, 1.1.3				
4.2.3.6.2	Characteristics of wheelsets	1.1.1, 1.1.2, 1.1.3				2.4.3
4.2.3.6.3	Characteristics of wheels	1.1.1, 1.1.2, 1.1.3				2.4.3
4.2.3.6.4	Characteristics of axles	1.1.1, 1.1.2, 1.1.3				
4.2.3.6.5	Axle box / bearings	1.1.1, 1.1.2, 1.1.3				
4.2.3.6.6	<del>Variable gauge wheelsets</del> <a href="#">Automatic variable gauge wheelsets systems</a>	1.1.1, 1.1.2, 1.1.3	<a href="#">1.2</a>			<a href="#">1.5</a>
4.2.3.6.7	Running gear for manual change of wheelsets	1.1.1, 1.1.2, 1.1.3				
4.2.4.2	Brake - Safety requirements	1.1.1, 1.1.3	1.2 2.4.2			
4.2.4.3.1	Brake - General functional requirements	1.1.1 2.4.1	2.4.2			
4.2.4.3.2.1	Brake performance – In-service brake	1.1.1, 1.1.2 2.4.1	2.4.2			1.5
4.2.4.3.2.2	Brake performance – Parking brake	2.4.1				2.4.3
4.2.4.3.3	Brake - Thermal capacity	1.1.1, 1.1.3 2.4.1				2.4.3
4.2.4.3.4	Brake - Wheel slide protection (WSP)	2.4.1	2.4.2			

 <b>OTIF</b>	<b>ROLLING STOCK</b> <b>FREIGHT WAGONS</b>			<b>UTP WAG</b> Page 10 of 151
	Status: <b>PROPOSAL</b>		TECH-20005 Annex	Original: EN

4.2.4.3.5	Friction elements for wheel tread brakes	1.1.1, 1.1.2, 1.1.3, 2.4.1				2.4.3
4.2.5	Environmental conditions	1.1.1 1.1.2				2.4.3
4.2.6.1	Fire safety	1.1.1 1.1.4				
4.2.6.1.2.1	Fire safety Barriers	1.1.4		1.3.2	1.4.2	
4.2.6.1.2.2	Fire safety Materials	1.1.4		1.3.2	1.4.2	
4.2.6.1.2.3	Fire safety Cables	1.1.4 1.1.5		1.3.2	1.4.2	
4.2.6.1.2.4	Fire safety – Flammable liquids	1.1.4		1.3.2	1.4.2	
4.2.6.2	Protection against electric hazard	1.1.5 2.4.1				
4.2.6.3	Attachment device for rear-end signal	1.1.1				

The essential requirements 1.3.1, 1.4.1, 1.4.3 and 1.4.5 of

UTP GEN-A<sup>40</sup> may fall under the scope of other legislation applicable in the Contracting State.<sup>11</sup>

Annex III to Directive [\(EU\) 2016/797](#)~~2008/57/EC~~ fall under the scope of other Union legislation.

## 4. CHARACTERISATION OF THE SUBSYSTEM

### 4.1. Introduction

In accordance with UTP GEN-B<sup>42</sup>, the rail system is divided into subsystems. Belonging to the subsystem rolling stock, freight wagons form a part of the rail system. The consistency of this system shall be verified.

The rail system, to which Directive [\(EU\) 2016/797](#)~~2008/57/EC~~ applies and of which freight wagons form a part, is an integrated system whose consistency shall be verified.

This consistency shall be checked in particular with regard to the specifications of the rolling stock subsystem and the compatibility with the network (section 4.2), its interfaces in relation to the other subsystems of the rail system in which it is integrated (sections 4.2 and 4.3), as well as the initial operating and maintenance rules (section 4.4 and 4.5)

<sup>40</sup> [A 94-01A/1.2011](#)

<sup>11</sup> Essential requirement 1.4.4 on noise pollution is deemed to be met for all vehicle-related parameters if the UTP Noise has been complied with.

<sup>42</sup> [A 94-01B/1.2012](#)

 <b>OTIF</b>	<b>ROLLING STOCK FREIGHT WAGONS</b>		<b>UTP WAG</b> Page 11 of 151	
	Status: <b>PROPOSAL</b>		TECH-20005 Annex	Original: EN

as requested by Article 18~~5~~(~~3~~4) of Directive [\(EU\) 2016/797](#)~~2008/57/EC~~.

The technical file, as set out in

UTP, General Provisions – GEN-C<sup>13</sup> and Article 10 § 6 of ATMF

Article 18~~5~~(~~3~~4) and Annex ~~IV~~I to Directive [\(EU\) 2016/797](#)~~2008/57/EC~~ (section 4.8),

shall contain in particular design related values concerning the compatibility with the network.

## 4.2. **Functional and technical specifications of the subsystem**

### 4.2.1. *General*

In light of the essential requirements in Chapter 3, the functional and technical specifications of the subsystem “rolling stock - freight wagons” are grouped and sorted out in the following points of this Chapter:

- Structures and mechanical parts
- Gauging and vehicle track interaction
- Brake
- Environmental conditions
- System protection

Except where this is strictly necessary for the interoperability of the rail system and to meet the relevant essential requirements, the functional and technical specifications of the freight wagon and its interfaces do not impose the use of any particular technical solutions.

When the functional and technical specifications that are necessary in order to achieve interoperability and to meet the essential requirements, have not been developed concerning a particular technical aspect, this aspect is identified as an open point in the relevant point. As required in

Article 8 § 7 of APTU

Article ~~5~~4(6) of Directive [\(EU\) 2016/797](#)~~2008/57/EC~~

all open points are listed in Appendix A.

In Appendix C a set of conditions is specified. The conformity with this set of conditions is optional. If this option is selected the conformity shall be assessed by

an Assessing Entity ~~as defined in the~~ [meaning of](#) Article 5 § 2 of ATMF and UTP GEN-E<sup>14</sup>, using the procedure as defined in ATMF Article 4 and UTP GEN-D<sup>15</sup>.

a notified body within the EC verification procedure.

In accordance with

<sup>13</sup> A 94-01C/1-2011

<sup>14</sup> A 94-01E/1-2011

<sup>15</sup> A 94-01D/3-2011

 <b>OTIF</b>	<b>ROLLING STOCK FREIGHT WAGONS</b>		<b>UTP WAG</b> Page 12 of 151	
Status: <b>PROPOSAL</b>		TECH-20005 Annex	Original: EN	Date: 17.06.2020

Article 8 § 6 of APTU,

Article ~~54~~(5) of Directive [\(EU\) 2016/797](#)~~2008/57/EC~~,

provisions may be made for specific cases for each [UTP](#).

~~UTP.~~

~~TSI.~~

Such provisions are indicated in Chapter 7.

As far as possible the assessment procedure for the requirements in section 4.2 is defined in Chapter 6. In these cases, the text of section 4.2 makes a reference to the corresponding points and sub points clauses of Chapter 6. If for a particular basic parameter, the separation of requirements and assessment procedures is not feasible, no reference is given.

#### 4.2.2. *Structures and mechanical parts*

##### 4.2.2.1. Mechanical Interface

###### 4.2.2.1.1. End coupling

The end coupling is the mechanical interface between units forming a train.

The coupling system shall be designed in a way that no human presence between the units to be coupled / uncoupled shall be required whilst either one unit is moving.

End couplings shall be resilient and capable of withstanding the forces in accordance with the defined design operating state of the unit.

###### 4.2.2.1.2. Inner coupling

The inner coupling is the mechanical interface between elements forming a unit.

The inner coupling shall be resilient and capable of withstanding the forces in accordance with the defined design operating state of the unit. The joint between two elements sharing the same running gear, is covered by point 4.2.2.2.

The longitudinal strength of the inner coupling(s) shall be equal to or higher than the one of the end coupling(s) of the unit.

###### 4.2.2.2. Strength of unit

The structure of a unit body, any equipment attachments and lifting and jacking points shall be designed such that no cracks, no significant permanent deformation or ruptures occur under the load cases defined in Chapter 5 of EN\_12663-2:2010.

In case of a rake of a rail compatible system composed of separate rail bogies connected to compatible road vehicles, the load cases may differ from those mentioned above, due to their bi-modal specification; in such a case, the load cases considered shall be described by the applicant based on a consistent set of specifications with consideration of the specific conditions of use related to train composition, shunting and operation.

~~Joining techniques shall be deemed to be covered by the demonstration of conformity in accordance to point 6.2.2.1.~~

The demonstration of conformity is described in point 6.2.2.1.

The [lifting and](#) jacking positions shall be marked on the unit. The marking shall comply with point 4.5.14~~3~~ of EN 15877-1:2012.

Note: joining techniques are also deemed to be covered by the demonstration of conformity in accordance with point 6.2.2.1.

 <b>OTIF</b>	<b>ROLLING STOCK</b> <b>FREIGHT WAGONS</b>		<b>UTP WAG</b> Page 13 of 151	
	Status: <b>PROPOSAL</b>		TECH-20005 Annex	Original: EN

#### 4.2.2.3. Integrity of the unit

The unit shall be designed so that all movable parts intended to close an aperture (access doors, tarpaulin, lids, hatches, etc.) are prevented against an unintentional movement of these parts.

Locking devices shall indicate their status (open/closed) and shall be visible outside the unit.

#### 4.2.3. Gauging and track interaction

##### 4.2.3.1. Gauging

This point concerns the rules for calculation intended for sizing the rolling stock to run on one or several networks without interference risk.

The compliance of a unit with the intended reference profile including the reference profile for the lower part shall be established by one of the methods set out in EN 15273-2:2013~~09~~+A1:2016.

The kinematic method, as described in EN 15273-2:2013~~09~~+A1:2016 shall be used to establish conformity, if any, between the reference profile established for the unit and the respective target reference profiles G1, GA, GB and GC including those used for the lower part G1~~E~~1 and G1~~E~~2.

##### 4.2.3.2. Compatibility with load carrying capacity of lines

The vertical loading characteristics of the unit shall be determined in order to check compatibility with the load carrying capacity of lines.

The permissible payload a unit may carry, for axle loads up to and including 25t, shall be determined by application of clauses 6.1 and 6.2 of EN 15528:2015~~08~~.

##### 4.2.3.3. Compatibility with train detection systems

If the unit is intended to be compatible with one or more of the following train detection systems, this compatibility shall be established

in accordance with the provisions of Appendix H of this UTP.

The parameters listed in (a), (b) and (c) shall be recorded in the technical file.<sup>-16</sup>

according to the provisions of the ~~Commission Decision 2012/88/EU~~ [ERA/ERTMS/033281 rev. 4.0.](#)

##### (a) Train detection systems based on track circuits.

- The greatest distance between two consecutive axles
- The greatest distance between buffer end and first axle
- The minimum axle load in all load conditions
- The electrical resistance between the running surfaces of the opposite

(<sup>17</sup>)

<sup>16</sup> The information included in the technical file is used by the rail transport undertaking to establish compatibility with the network on which it will operate the vehicle.

<sup>17</sup> EU provisions included in ~~Commission Decision 2012/88/EU~~ [\(see above: ERA/ERTMS/033281 rev. 4.0.\)](#)



 <b>OTIF</b>	<b>ROLLING STOCK</b> <b>FREIGHT WAGONS</b>		<b>UTP WAG</b> Page 14 of 151	
	Status: <b>PROPOSAL</b>		TECH-20005 Annex	Original: EN

wheels of a wheelset.

(b) Train detection systems based on axle counters.

- The greatest distance between two consecutive axles (19)
- The shortest distance between two consecutive axles
- The distance between the end axles of the wagon
- The distance between the end of the vehicle (e.g. buffer) and the first axle of the unit <sup>18</sup>
- The wheel diameter
- The metal-free space around wheels
- The characteristics of the wheel material regarding magnetic fields

(c) Train detection systems based on loop equipment.

- The metal-mass of the vehicle (20)

#### 4.2.3.4. Axle bearing condition monitoring

It shall be possible to monitor the axle bearing condition either by

- line side detection equipment or
- on-board equipment.

If the unit is intended to be capable of being monitored by line side equipment on the 1435 mm track gauge network the unit shall be compliant with clauses 5.1 and 5.2 of EN 15437-1:2009 in order to ensure sufficient visibility.

For units intended to be operated on the networks with track gauges of 1524 mm, 1600 mm, 1668 mm, the corresponding values in table 2 referring to the parameters of the standard EN 15437-1:2009 shall be applied.

Table 2

**Target and prohibitive zone for units intended to be operated on particular networks**

	<b>Y<sub>TA</sub> [mm]</b>	<b>W<sub>TA</sub> [mm]</b>	<b>L<sub>TA</sub> [mm]</b>	<b>Y<sub>PZ</sub> [mm]</b>	<b>W<sub>PZ</sub> [mm]</b>	<b>L<sub>PZ</sub> [mm]</b>
1524 mm (both areas are relevant)	1080±35	≥50	≥200	1080±5	≥140	≥500
	894±2	≥14	≥200	894±2	≥28	≥500
1600 mm	1110±2	>70	>180	1110±2	>125	>500

<sup>18</sup> This value is used to define the distance between two consecutive axles of coupled wagons.

<sup>19</sup> EU provisions included in [Commission Decision 2012/88/EU \(see above: ERA/ERTMS/033281 rev. 4.0.\)](#)

<sup>20</sup> EU provisions included in [Commission Decision 2012/88/EU \(see above: ERA/ERTMS/033281 rev. 4.0.\)](#)

 <b>OTIF</b>	<b>ROLLING STOCK</b> <b>FREIGHT WAGONS</b>		<b>UTP WAG</b> Page 15 of 151	
	Status: <b>PROPOSAL</b>		TECH-20005 Annex	Original: EN

1668 mm	1176±10	≥55	≥100	1176±10	≥110	≥500
---------	---------	-----	------	---------	------	------

~~The specifications of the design and the conformity assessment of on-board equipment is an open point in this~~

~~UTP.~~

~~TSI.~~

If the unit is intended to be capable of being monitored by on-board equipment, the following requirements shall apply:

- This equipment shall be able to detect a deterioration of any of the axle box bearings of the unit.
- The bearing condition shall be evaluated either by monitoring its temperature, or its dynamic frequencies or some other suitable bearing condition characteristic.
- The detection system shall be located entirely on board the unit, and diagnosis messages shall be available on board the unit.
- The diagnosis messages delivered and how they are made available shall be described in the operating documentation set out in section 4.4, and in the maintenance rules described in section 4.5.

#### 4.2.3.5. Running safety

The dynamic behaviour of a vehicle has a strong influence on safety against derailment, running safety and track loading.

##### 4.2.3.5.1. Safety against derailment running on twisted track

The unit shall be designed to ensure safe running on twisted track, taking into account specifically the transition phase between canted and level track and cross level deviations.

The demonstration of conformity is described in point 6.2.2.2.

##### 4.2.3.5.2. Running dynamic behaviour

The unit shall be designed to provide safe movement up to the maximum design speed.

The running dynamic behaviour of a unit shall be proven either by

- following the procedures set out in Chapter 4, 5 and 7 of EN 14363:2016~~05~~, or
- performing simulations using a validated model.

The demonstration of conformity is described in point 6.2.2.3.

Running dynamic behaviour is permitted to be assessed at interoperability constituent

~~element of construction~~

interoperability constituent

level in accordance with point 6.1.2.1. In this case, a specific test or simulation at subsystem level is not required.

#### 4.2.3.6. Running gear

The running gear guarantees to carry and guide the unit safely as well as to transmit braking forces where so required.

 <b>OTIF</b>	<b>ROLLING STOCK</b> <b>FREIGHT WAGONS</b>		<b>UTP WAG</b> Page 16 of 151	
	Status: <b>PROPOSAL</b>		TECH-20005 Annex	Original: EN

#### 4.2.3.6.1. Structural design of bogie frame

The integrity of the structure of a bogie frame, all attached equipment and body to bogie connection shall be demonstrated based on methods as set out in point 6.2 of EN 13749:2011.

The integrity of the structure of a bogie frame is permitted to be assessed at [interoperability constituent](#)

~~element of construction~~

~~interoperability constituent~~

level in accordance with point 6.1.2.1. In this case a specific test or simulation at subsystem level is not required.

#### 4.2.3.6.2. Characteristics of wheelsets

The wheelset assembly shall be able to transmit forces and torque between the fitted parts in accordance with the area of use.

The geometric dimensions of the wheelsets, as defined in figure 1, shall be compliant with limit values specified in table 3. These limit values shall be taken as design values and shall be stated as in-service limit values in the maintenance file described in section 4.5.

The demonstration of conformity is described in point 6.1.2.2.

Fig. 1

**Symbols for wheelsets used in table 3**

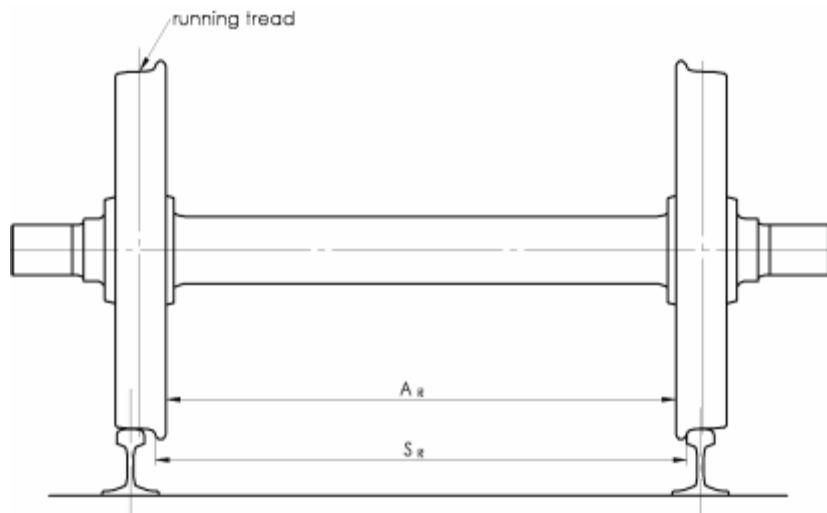



Table 3

**Limits of use of the geometric dimensions of wheelsets**

Designation		Wheel diam. D [mm]	Minimum value [mm]	Maximum value [mm]
1435	Front-to-front dimension ( $S_R$ )	$330 \leq D \leq 760$	1415	1426
	$S_R = A_R + S_{d, \text{left}} + S_{d, \text{right}}$	$760 < D \leq 840$	1412	1426

 <b>OTIF</b>	<b>ROLLING STOCK</b> <b>FREIGHT WAGONS</b>		<b>UTP WAG</b> Page 17 of 151	
	Status: <b>PROPOSAL</b>		TECH-20005 Annex	Original: EN

	Back to back distance ( $A_R$ )	$D > 840$	1410	1426
		$330 \leq D \leq 760$	1359	1363
		$760 < D \leq 840$	1358	1363
		$D > 840$	1357	1363
1524 mm	Front-to-front dimension ( $S_R$ ) $S_R = A_R + S_{d, left} + S_{d, right}$	$400 \leq D < 840$	1492	1514
		$D \geq 840$	1487	1514
	Back to back distance ( $A_R$ )	$400 \leq D < 840$	1444	1448
		$D \geq 840$	1442	1448
1600 mm	Front-to-front dimension ( $S_R$ ) $S_R = A_R + S_{d, left} + S_{d, right}$	$690 \leq D \leq 1016$	1573	1592
	Back to back distance ( $A_R$ )	$690 \leq D \leq 1016$	1521	1526
1668 mm	Front-to-front dimension ( $S_R$ ) $S_R = A_R + S_{d, left} + S_{d, right}$	$330 \leq D < 840$	1648 <sup>21</sup>	1659
		$840 \leq D \leq 1250$	1643 <sup>22</sup>	1659
	Back to back distance ( $A_R$ )	$330 \leq D < 840$	1592	1596
		$840 \leq D \leq 1250$	1590	1596

#### 4.2.3.6.3. Characteristics of wheels

The geometrical dimensions of the wheels as defined in Figure 2 shall be compliant with limit values specified in table 4.

*Table 4*  
**Limits of use of the geometric dimensions of wheels**

Designation		Wheel diam. D [mm]	Minimum value [mm]	Maximum value [mm]
1435	Width of the rim ( $B_R$ ) (with maximum BURR of 5 mm)	$D \geq 330$	133	140
	Thickness of the flange ( $S_d$ )	$330 \leq D \leq 760$	27,5	33

<sup>21</sup> Two-axle wagons with axle load up to 22.5t the value shall be taken as 1651 mm

<sup>22</sup> Two-axle wagons with axle load up to 22.5t the value shall be taken as 1651 mm

 <b>OTIF</b>	<b>ROLLING STOCK</b> <b>FREIGHT WAGONS</b>		<b>UTP WAG</b> Page 18 of 151
	Status: <b>PROPOSAL</b>	TECH-20005 Annex	Original: EN

	Height of the flange ( $S_h$ )	$760 < D \leq 840$	25	33	
		$D > 840$	22	33	
		$330 \leq D \leq 630$	31,5	36	
		$630 < D \leq 760$	29,5	36	
		$D > 760$	27,5	36	
Face of the flange ( $q_R$ )	$D \geq 330$	6,5	-		
1524 mm	Width of the rim ( $B_R$ ) (with maximum BURR of 5 mm)	$D \geq 400$	134	140	
	Thickness of the flange ( $S_d$ )	$400 \leq D < 760$	27,5	33	
		$760 \leq D < 840$	25	33	
		$D \geq 840$	22	33	
	Height of the flange ( $S_h$ )	$400 \leq D < 630$	31,5	36	
		$630 \leq D < 760$	29,5	36	
		$D \geq 760$	27,5	36	
	Face of the flange ( $q_R$ )	$D \geq 400$	6,5	-	
	1600 mm	Width of the rim ( $B_R$ ) (with maximum BURR of 5 mm)	$690 \leq D \leq 1016$	137	139
		Thickness of the flange ( $S_d$ )	$690 \leq D \leq 1016$	26	33
Height of the flange ( $S_h$ )		$690 \leq D \leq 1016$	28	38	
Face of the flange ( $q_R$ )		$690 \leq D \leq 1016$	6,5	-	
1668 mm	Width of the rim ( $B_R$ ) (with maximum BURR of 5 mm)	$D \geq 330$	133	140	
	Thickness of the flange ( $S_d$ )	$330 \leq D \leq 840$	27,5	33	
		$D > 840$	22 (PT); 25 (ES)	33	
	Height of the flange ( $S_h$ )	$330 \leq D \leq 630$	31,5	36	
		$630 \leq D \leq 760$	29,5	36	
		$D > 760$	27,5	36	
	Face of the flange ( $q_R$ )	$D \geq 330$	6,5	-	

These limit values shall be taken as design values and shall be stated as in-service limit values in the maintenance file described in section 4.5.

*Fig. 2*

**Symbols for wheels used in table 4**

 <b>OTIF</b>	<b>ROLLING STOCK</b> <b>FREIGHT WAGONS</b>		<b>UTP WAG</b> Page 19 of 151
	Status: <b>PROPOSAL</b>	TECH-20005 Annex	Original: EN

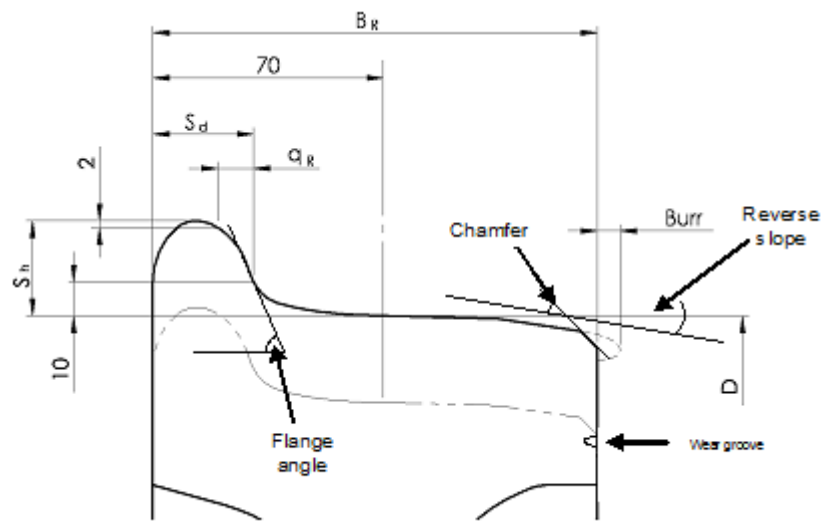

The mechanical characteristics of the wheels shall ensure the transmission of forces and torque as well as the resistance against thermal load where so required in accordance with the area of use.

The demonstration of conformity is described in point 6.1.2.3.

#### 4.2.3.6.4. Characteristics of axles

The characteristics of the axle shall ensure the transmission of forces and torque in accordance with the area of use.

The demonstration of conformity is described in point 6.1.2.4.

The traceability of axles shall take into account the findings of the ERA Task Force on Freight Maintenance (see “Final report on the activities of the Task Force Freight Wagon Maintenance”

, version 1.0 of 5 October 2010,

published on the ERA website <http://www.era.europa.eu>).

#### 4.2.3.6.5. Axle boxes / bearings

The axle box and the rolling bearing shall be designed with consideration of mechanical resistance and fatigue characteristics. Temperature limits reached in service relevant for the hot box detection shall be defined.

The demonstration of conformity is described in point 6.2.2.4.

#### 4.2.3.6.6. ~~Automatic variable gauge wheelsets systems~~

~~This requirement is applicable to units equipped with variable gauge wheelsets with changeover between two track gauges.~~

~~The changeover mechanism of the wheelset shall ensure the safe locking~~

~~— of the wheels and~~

~~— of the corresponding brake equipment~~

~~in the correct intended axial position considering the dynamic effects in accordance with the design operating state of the unit.~~

 <b>OTIF</b>	<b>ROLLING STOCK</b> <b>FREIGHT WAGONS</b>		<b>UTP WAG</b> Page 20 of 151	
	Status: <b>PROPOSAL</b>		TECH-20005 Annex	Original: EN

~~The conformity assessment of the requirements specified in this point is an open point.~~

This requirement is applicable to units equipped with an automatic variable gauge system with changeover mechanism of the axial position of the wheels allowing the unit to be compatible with 1-435 mm track gauge and other track gauge(s) within the scope of this UTP by means of passage through a track gauge changeover facility.

The changeover mechanism shall ensure the locking in the correct intended axial position of the wheel.

After passage through the track gauge changeover facility, the verification of the state of the locking system (locked or unlocked) and of the position of the wheels shall be performed by one or more of the following means: visual control, on-board control system or infrastructure/facility control system. In case of on-board control system, a-continuous monitoring shall be possible.

If a-running gear is equipped with brake equipment subject to a change in position during the gauge change operation, the automatic variable gauge system shall ensure the position and safe locking in the correct position of this equipment simultaneously to those of the wheels.

The failure of the locking of the position of the wheels and braking equipment (if relevant) during operation has typical credible potential to lead directly to a catastrophic accident (resulting in multiple fatalities); considering this severity of the failure consequence, it shall be demonstrated that the risk is controlled to an acceptable level.

The automatic variable gauge system is defined as an interoperability constituent (point 5.3.4b) and is part of the interoperability constituent wheelset (point 5.3.2). The conformity assessment procedure is specified in point 6.1.2.6 (interoperability constituent level), point 6.1.2.2 (safety requirement) and in point 6.2.2.4a (subsystem level).

The track gauges the unit is compatible with shall be recorded in the technical documentation.

A description of the changeover operation in normal mode, including the type(s) of track gauge changeover facility(ies) the unit is compatible with, shall be part of the technical documentation (see also section 4.4).

The requirements and conformity assessments required in other sections of this UTP apply independently for each wheel position corresponding to one track gauge and have to be documented accordingly.

#### 4.2.3.6.7. Running gear for manual change of wheelsets

The requirement is applicable to units prepared to run on different track gauges, by means of a physical change of wheelset.

The unit shall be equipped with a locking mechanism in order to ensure the correct position of its brake equipment in the different configurations considering the dynamic effects in accordance with the design operating state of the unit.

The demonstration of conformity is described in point 6.2.2.5.

#### 4.2.4. Brake

##### 4.2.4.1. General

The purpose of the train brake system is to ensure that

- the train's speed can be reduced,
- the train's speed can be maintained on a slope

 <b>OTIF</b>	<b>ROLLING STOCK</b> <b>FREIGHT WAGONS</b>		<b>UTP WAG</b> Page 21 of 151	
	Status: <b>PROPOSAL</b>		TECH-20005 Annex	Original: EN

- the train can be stopped within the maximum allowable braking distance and that
- the train can be immobilised.

Primary factors that influence the braking performance and the braking process are

- the braking power,
- the train mass,
- the speed,
- the allowable braking distance,
- the available adhesion and
- the track gradient.

The brake performance of a train is derived from the individual brake performance of each unit in the train.

#### 4.2.4.2. Safety requirements

The braking system contributes to the safety level of the railway system. Therefore, the design of the braking system of a unit has to undergo a risk assessment in accordance with

UTP GEN-G Risk Evaluation and Assessment<sup>23</sup>,

[Commission Implementing Regulation \(EU\) No 402/2013](#) ~~Commission Regulation (EC) No 352/2009~~<sup>24</sup>

considering the hazard of complete loss of the brake capability of the unit. The severity level shall be deemed as catastrophic when

- it affects the unit alone (combination of failures) or,
- it affects the brake capability of more than the unit (single fault).

The fulfilment of the conditions of C.9 and C.14 of Appendix C is presumed to be in conformity with this requirement.<sup>25</sup>

#### 4.2.4.3. Functional and technical requirements

##### 4.2.4.3.1. General functional requirements

The brake equipment of the unit shall provide the functions of braking such as the application and the release of the brake, upon a transmitted signal. The brake shall be

- continuous (the brake application or release signal is transmitted from a central command to the whole train by a control line),
- automatic (an inadvertent disruption of the control line shall lead to brake activation on all units of the train bringing each part to stand still),
- disengageable, which enables its release and isolation.

<sup>23</sup> [A 94-01G/1.2012](#)

<sup>24</sup> [OJ L 121, 3.5.2013, p. 8](#) ~~[OJ L 108, 29.04.2009, p.4.](#)~~

<sup>25</sup> For this ~~reason~~ [reason](#), no specific risk evaluation and assessment are required when the technical solutions of C.9 and C.14 of Appendix C are used.



 <b>OTIF</b>	<b>ROLLING STOCK</b> <b>FREIGHT WAGONS</b>		<b>UTP WAG</b> Page 22 of 151	
	Status: <b>PROPOSAL</b>		TECH-20005 Annex	Original: EN

#### 4.2.4.3.2. Brake performance

##### 4.2.4.3.2.1. Service brake

The brake performance of a train or a unit is its ability to decelerate. It is the result of the braking power available to decelerate the train or unit within defined limits and all factors involved in the conversion and dissipation of energy including train resistance.

The brake performance of a unit shall be calculated in accordance with one of the following documents:

- EN 14531-6:2009 or
- UIC ~~leaflet~~ 544-1:2014<sup>3</sup>.

The calculation shall be validated by tests. Brake performance calculation in accordance with UIC 544-1:2014 shall be validated as set out in UIC 544-1:2014<sup>3</sup>.

##### 4.2.4.3.2.2. Parking brake

A Parking Brake is a brake used to prevent parked rolling stock moving under the specified conditions taking into account the place, wind, gradient and rolling stock loading state, until intentionally released.

If the unit is equipped with a parking brake, the following requirements shall be met:

- the immobilisation shall remain until intentionally released.
- where it is not possible to identify the state of the parking brake directly, an indicator showing the state shall be provided on both sides on the outside of the vehicle.
- the minimum parking brake ~~performance~~force, considering no wind, shall be determined by calculations as defined in clause 6 of EN 14531-6:2009.
- ~~the minimum performance of the parking brake shall be marked on the unit. The marking shall comply with clause 4.5.25 of EN 15877 1:2012.~~ The parking brake of a unit shall be designed considering a wheel/rail (steel/steel) adhesion factor not higher than 0,12.

##### 4.2.4.3.3. Thermal capacity

The brake equipment shall be able to withstand one emergency brake application without any loss of brake performance due to thermal or mechanical effects.

The thermal load, the unit is capable to withstand without any adverse loss of brake performance due to thermal or mechanical effects, shall be defined and expressed in terms of speed, axle load, gradient and brake distance.

The demonstration of conformity is described in point 6.2.2.6.

A slope of 21 ‰ at 70 km/h during 40 km may be considered as the reference case for the thermal capacity which results in a braking power of 45 kW per wheel during 34 minutes for a nominal wheel diameter of 920 mm and an axle load of 22.5 t.

##### 4.2.4.3.4. Wheel slide protection (WSP)

Wheel slide protection (WSP) is a system designed to use the maximum available adhesion by decreasing, holding or increasing the brake force to prevent wheel sets from locking and uncontrolled sliding. Thereby the stopping distance shall be optimized

If an electronic WSP-control is used negative effects caused by malfunctions of WSP shall be reduced by suitable system design processes and technical configuration.

 <b>OTIF</b>	<b>ROLLING STOCK</b> <b>FREIGHT WAGONS</b>		<b>UTP WAG</b> Page 23 of 151
	Status: <b>PROPOSAL</b>	TECH-20005 Annex	Original: EN

The WSP shall not alter the functional characteristics of the brakes. The vehicle's air equipment shall be dimensioned such that the air consumption of the WSP does not impair the performance of the pneumatic brake. The design process of the WSP shall take into account that the WSP has no detrimental effect on the constituent parts of the vehicle (brake gear, wheel tread, axle boxes, etc.).

The following types of units shall be fitted with WSP:

- types of units equipped with all types of brake block except composite brake blocks, for which the maximum mean utilisation of adhesion is greater than 0,12.
- types of units equipped with disc brakes only and/or with composite brake blocks, for which the maximum mean utilisation of adhesion is greater than 0,11.

#### 4.2.4.3.5. Friction elements for wheel tread brakes

The friction element for wheel tread brakes (i.e. brake block) generates brake forces by friction when engaged with the wheel tread.

If wheel tread brakes are used the characteristics of the friction element shall contribute reliably to achieving the intended brake performance.

The demonstration of conformity is described in point 6.1.2.5-~~of this~~.

~~UTP:~~

~~TSI:~~

#### 4.2.5. *Environmental conditions*

The design of the unit, as well as its constituents shall take into account the environmental conditions to which this rolling stock will be subjected to.

The environmental parameters are described in the clauses below. For each environmental parameter, a nominal range is defined, which is the most commonly encountered in Europe, and is the basis for the interoperable unit.

For certain environmental parameters ranges other than the nominal one are defined. In that case, a range shall be selected for the design of the unit.

For the functions identified in the clauses below, design and/or testing provisions taken to ensure that the rolling stock is meeting the

~~UTP~~

~~TSI~~

requirements in this range shall be described in the technical file.

Depending on the ranges selected and on provisions taken (described in the technical file), appropriate operating rules could be necessary when the unit designed for the nominal range is operated on a particular line where the nominal range is exceeded at certain periods of the year.

The ranges, if different from the nominal one, to be selected to avoid any restrictive operating rule(s) linked to environmental conditions, are specified by the [Contracting States](#)

~~Contracting States~~

~~Member States~~

and are listed in section 7.4.

The unit and its constituents shall be designed under consideration of one or several of the following temperature classes allocated to external air temperature ranges

 <b>OTIF</b>	<b>ROLLING STOCK</b> <b>FREIGHT WAGONS</b>		<b>UTP WAG</b> Page 24 of 151	
	Status: <b>PROPOSAL</b>		TECH-20005 Annex	Original: EN

- T1: -25°C to +40°C (nominal),
- T2: -40°C to +35°C and
- T3: -25°C to +45°C

The unit shall meet the requirements ~~of this~~

~~UTP~~

~~TSI~~

without degradation for snow, ice and hail conditions as defined in clause 4.7 of EN 50125-1:1999~~2014~~, which correspond to the nominal range.

Where more severe ‘snow, ice and hail’ conditions than considered in the standard are selected, the unit and its constituents shall then be designed to meet

~~UTP~~

~~TSI~~

requirements considering the combined effect with low temperature according to the temperature range chosen.

In relation with the temperature range T2 and with the severe conditions for snow, ice and hail, the provisions taken to meet

~~UTP~~

~~TSI~~

requirements in these severe conditions shall be identified and verified, in particular design and/or testing provisions considering the following functions:

- Coupling function restricted to the resiliency of couplings.
- Brake function, including brake equipment.

The demonstration of conformity is described in point 6.2.2.7.

#### 4.2.6. System protection

##### 4.2.6.1. Fire safety

###### 4.2.6.1.1. General

All significant potential fire sources (high risk components) on the unit shall be identified. The fire safety aspects of the unit design shall be aimed at

- preventing a fire from occurring,
- limiting the effects if a fire occurs.

The goods carried on the unit are not part of the unit and do not have to be taken into account in the conformity assessment.

###### 4.2.6.1.2. Functional and technical specification

###### 4.2.6.1.2.1. Barriers

In order to limit the effects of fire, fire barriers with integrity of at least 15 minutes shall be installed between the identified potential fire sources (high risk components) and the carried load.

The demonstration of conformity is described in point 6.2.2.8.1.

 <b>OTIF</b>	<b>ROLLING STOCK</b> <b>FREIGHT WAGONS</b>		<b>UTP WAG</b> Page 25 of 151
	Status: <b>PROPOSAL</b>	TECH-20005 Annex	Original: EN

#### 4.2.6.1.2.2. Materials

All permanent materials used on the unit shall have limited ignitability and flame spread properties, unless

- the material is separated from all potential fire risks on the unit by a fire barrier and the safe application is supported by a risk assessment or
- the component has a mass <400g, and is located within a horizontal distance of  $\geq 40$  mm and a vertical distance of  $\geq 400$  mm to other non-tested components.

The demonstration of conformity is described in point 6.2.2.8.2.

#### 4.2.6.1.2.3. Cables

The selection and installation of electrical cables shall take into account their fire behaviour properties.

The demonstration of conformity is described in point 6.2.2.8.3.

#### 4.2.6.1.2.4. Flammable liquids

The unit shall be provided with measures preventing a fire from occurring and spreading due to leakage of flammable liquids or gases.

The demonstration of conformity is described in point 6.2.2.8.4.

### 4.2.6.2. Protection against electrical hazards

#### 4.2.6.2.1. Protective measures against indirect contact (protective bonding)

The impedance between vehicle body and the running rail shall be low enough to prevent hazardous voltages between them.

Units shall be bonded in accordance with the provisions as described in clause 6.4 of EN 50153:2002~~14~~.

#### 4.2.6.2.2. Protective measures against direct contact

The electrical installations and equipment of a unit shall be designed so as to protect persons from electric shock.

The unit shall be designed so that direct contact is prevented following the provisions set out in clause 5 of EN 50153:2002~~14~~.

#### 4.2.6.3. Attachment devices for rear-end signal

On all units designed to receive a rear-end signal, two devices at the end of the unit shall provide for the installation of two lamps or two reflective plates as set out in Appendix E on the same height above rail not higher than 2000 mm.

The dimensions and clearance of these attachment devices shall be as described in [Figure 11 of EN 16116-2:2013](#)

**Appendix J.**

**chapter 1 of ERA technical document  
ERA/TD/2012-04/INT version 1.2 of  
18.01.2013 published on the ERA website  
(<http://www.era.europa.eu>).**

### 4.3. Functional and technical specification of the interfaces

The following sections contain tables 5, 6 and

 <b>OTIF</b>	<b>ROLLING STOCK FREIGHT WAGONS</b>		<b>UTP WAG</b> Page 26 of 151	
	Status: <b>PROPOSAL</b>		TECH-20005 Annex	Original: EN

7, with a three-column layout. The left and middle columns are part of this UTP.

The [substance in the](#) middle column also appears in the equivalent EU TSI, although the title of the middle column has been adapted<sup>26</sup> ~~in order to fit both the EU and the OTIF document.~~

#### 4.3.1. Interface with the subsystem “infrastructure”

Table 5

##### Interface with infrastructure subsystem

Reference to the OTIF or national regulations	Reference in this UTP/ <del>TSI</del>	Reference Commission Decision 2011/275/EU
There are no infrastructure requirements in OTIF regulations. In accordance with ATMF Article 6 §2, it is the responsibility of the rail transport undertaking to ensure the compatibility of the vehicle with the infrastructure it is operated on. The track design and layout are the responsibility of the Contracting State.	4.2.3.1 Gauging	4.2.4.1 Minimum structure gauge 4.2.4.2 Distance between track centres 4.2.4.5 Minimum radius of vertical curve
	4.2.3.2 Compatibility with load carrying capacity of lines	4.2.7.1 Track resistance to vertical loads 4.2.7.3 Lateral track resistance 4.2.8.1 Resistance of bridges to traffic loads 4.2.8.2 Equivalent vertical loading for earthworks and earth pressure effects 4.2.8.4 Resistance of existing bridges and earthworks to traffic loads
	4.2.3.5.2 Running dynamic behaviour	4.2.9 Track geometrical quality
	4.2.3.6.2 Characteristics of wheelsets	4.2.5.1 Nominal track gauge 4.2.5.6 Rail head profile for plain line
	4.2.3.6.3 Characteristics of wheels	4.2.6.2 In service geometry of switches and crossings

<sup>26</sup> ~~This middle column is not therefore exactly the same as the EU Regulation.~~

 <b>OTIF</b>	<b>ROLLING STOCK FREIGHT WAGONS</b>		<b>UTP WAG</b> Page 27 of 151	
	Status: <b>PROPOSAL</b>		TECH-20005 Annex	Original: EN

4.3.2. *Interface with the subsystem “operation and traffic management”*

Table 6

**Interface with operation and traffic management subsystem**

Reference to the OTIF or national regulations	Reference in this UTP/ <del>TSI</del>	Reference Commission Decision 2011/314/EU
COTIF does not define contingency arrangements; national contingency arrangements apply. The requirements in section 4.2.2.2 are deemed compatible with all national contingency measures.	4.2.2.2 Strength of unit - Lifting and jacking	4.2.3.6.3 Contingency arrangements
In accordance with ATMF Article 6 §2, it is the responsibility of the rail transport undertaking to ensure the compatibility of the vehicle with the infrastructure it is operated on.	4.2.3.1 Gauging	4.2.2.5 Train composition
	4.2.3.2 Compatibility with load carrying capacity of lines	4.2.2.5 Train composition
	4.2.4 Brake	4.2.2.6 Train braking
	4.2.6.3 Attachment devices for rear-end signal. Appendix E Rear-end signal	4.2.2.1.3.2

4.3.3. *Interface with the subsystem “control, command and signalling”*

Table 7

**Interface with control, command and signalling subsystem**

Reference to the OTIF or national regulations	Reference in this UTP/ <del>TSI</del>	Reference <a href="#">ERA/ERTMS/033281 rev. 4.0</a> <del>Commission Decision 2012/88/EU</del> <del>Annex A, table A2, index 77</del>

 <b>OTIF</b>	<b>ROLLING STOCK FREIGHT WAGONS</b>		<b>UTP WAG</b> Page 28 of 151	
	Status: <b>PROPOSAL</b>		TECH-20005 Annex	Original: EN

Reference to the OTIF or national regulations	Reference in this UTP/ <del>TSI</del>	Reference <a href="#">ERA/ERTMS/033281 rev. 4.0</a> <del>Commission Decision 2012/88/EU</del> <del>Annex A, table A2, index 77</del>
The interfaces for compatibility with train detection systems are set out in Appendix H of this UTP.	4.2.3.3 a) Rolling stock characteristics compatible with train detection system based on track circuits	<ul style="list-style-type: none"> <li>– axle distances (3.1.2.1, 3.1.2.4, 3.1.2.5 and 3.1.2.6),</li> <li>– vehicle axle loads (3.1.7.1)</li> <li>– impedance between wheels (3.1.9),</li> <li>– use of composite brake blocks (3.1.6),</li> </ul>
	4.2.3.3 b) Rolling stock characteristics compatible with train detection system based on axle counters	<ul style="list-style-type: none"> <li>– axle distances (3.1.2.1, 3.1.2.2, 3.1.2.5 and 3.1.2.6),</li> <li>– wheel geometry (3.1.3.1 - 3.1.3.4),</li> <li>– metal / inductive components-free space between wheels (3.1.3.5)</li> <li>– wheel material (3.1.3.6).</li> </ul>
	4.2.3.3 c) Rolling stock characteristics compatible with train detection system based on loop equipment	<ul style="list-style-type: none"> <li>– vehicle metal construction ( 3.1.7.2).</li> </ul>

#### 4.4. **Operating rules**

The rail transport undertaking shall control the risks associated with the use of the wagon. Operating rules covering the activities and measures set out in Appendix I shall be established<sup>27</sup>.

Operating rules are developed within the procedures described in the railway undertaking safety management system.

These rules take into account the documentation related to operation which forms a part of the technical file as required in

UTP GEN-C, General Provisions – Technical File<sup>28</sup>.

Article ~~185(34)~~ of and as set out in Annex ~~IV~~ to Directive [\(EU\) 2016/797](#)~~2008/57/EC~~.

For the safety critical components (see also 4.5), the specific operational and operational traceability requirements are developed by the designers/manufacturers at design phase and through a collaboration between designers/manufacturers and the railway undertakings concerned or the wagon keeper concerned after vehicles have entered into operation.

<sup>27</sup> Unlike EU law, C-OTIF law does not specify who should establish these operating rules.

<sup>28</sup> ~~A 94 01C/1.2011~~

 <b>OTIF</b>	<b>ROLLING STOCK</b> <b>FREIGHT WAGONS</b>		<b>UTP WAG</b> Page 29 of 151
	Status: <b>PROPOSAL</b>	TECH-20005 Annex	Original: EN

The documentation related to operation describes the characteristics of the unit in relation to the design operating state to be considered in order to define the operating rules in normal and in various reasonably foreseeable degraded modes.

The documentation related to operation is composed of:

- a description of operation in normal mode, including the operational characteristics and limitations of the unit (e.g. vehicle gauge, maximum design speed, axle loads, brake performance, compatibility with train detection systems, permitted environmental conditions, [type\(s\) and operation of track gauge changeover facility\(ies\) the unit is compatible with](#)).
- a description of operation in degraded mode (~~when—equipment~~[when equipment](#) or functions described in this [UTP](#)

~~UTP~~

~~TSI~~

suffer safety failures) as far as can reasonably predicted, together with the related acceptable limits and operating conditions of the unit that could be experienced.

- [a safety critical components list: ~~t~~The safety critical components list shall contain the specific operational and operational traceability requirements.](#)

The applicant shall provide the initial version of the documentation related to operating rules. This documentation might be modified later in accordance with the corresponding

Rules

Union legislation,

taking into account the existing operating and maintenance conditions of the unit. The

Assessing Entity

Notified Body

shall verify only that the documentation on operation is provided.

#### 4.5. Maintenance rules

Maintenance is a set of activities intended to keep a functional unit in, or to restore it to a state in which it can perform its required function.

The following documents being part of the technical file as required in

UTP GEN-C<sup>29</sup>, General Provisions – Technical File

Article ~~185~~(~~34~~) of and as set out in Annex ~~IV~~ to Directive [\(EU\) 2016/797](#)~~2008/57/EC~~

are necessary to undertake maintenance activities on the units:

- ~~g~~General documentation (point 4.5.1)
- ~~t~~The maintenance design justification file (point 4.5.2) and
- ~~t~~The maintenance description file (point 4.5.3).

The applicant shall provide the three documents described in 4.5.1, 4.5.2 and 4.5.3. This documentation might be modified later in accordance with the corresponding

OTIF regulations,

EU legislation,

<sup>29</sup> A 94 01C/1.2011



 <b>OTIF</b>	<b>ROLLING STOCK FREIGHT WAGONS</b>		<b>UTP WAG</b> Page 30 of 151	
Status: <b>PROPOSAL</b>		TECH-20005 Annex	Original: EN	Date: 17.06.2020

taking into account the existing operating and maintenance conditions of the unit. The

Assessing Entity

Notified Body

shall verify only that the documentation on maintenance is provided.

The keeper

The applicant or any entity authorised by the applicant (e.g. a keeper)

shall provide this documentation to the entity in charge of maintenance as soon as it is assigned for the maintenance of the unit.

On the basis of these three documents, the entity in charge of maintenance shall define a maintenance plan and appropriate maintenance requirements at maintenance operational level under its sole responsibility (not in the scope of the assessment against this UTP).

The documentation includes a list of safety critical components. Safety critical components are components for which a single failure has a credible potential to lead directly to

a serious accident.

a serious accident as defined in Article 3(12) of Directive (EU) 2016/798.

The safety critical components and their specific servicing, maintenance and maintenance traceability requirements are identified by the designers/manufacturers at design phase and through a collaboration between designers/manufacturers and the ~~concerned~~ entities in charge of maintenance concerned, after vehicles have entered into operation.

#### 4.5.1. *General documentation*

The general documentation comprises of:

- Drawings and description of the unit and its components.
- Any legal requirement concerning the maintenance of the unit.
- Drawing of systems (electrical, pneumatic, hydraulic and control-circuit diagrams).
- Additional on-board systems (description of the systems including description of functionality, specification of interfaces and data processing and protocols).
- Configuration files for each vehicle (parts list and bill of material) to enable (in particular but not only) traceability during maintenance activities.

#### 4.5.2. *Maintenance design justification file*

The maintenance design justification file explains how maintenance activities are defined and designed in order to ensure that the rolling stock characteristics will be kept within permissible limits of use during its lifetime. The file shall give input data in order to determine the criteria for inspection and the periodicity of maintenance activities. The maintenance design justification file consists of

- Precedents, principles and methods used to design the maintenance of the unit.
- Precedents, principles and methods used to identify the safety critical components and their specific operational, servicing, maintenance and traceability requirements.
- Limits of the normal use of the unit (e.g. km/month, climatic limits, foreseen types of loads etc.).

 <b>OTIF</b>	<b>ROLLING STOCK FREIGHT WAGONS</b>		<b>UTP WAG</b> Page 31 of 151	
Status: <b>PROPOSAL</b>		TECH-20005 Annex	Original: EN	Date: 17.06.2020

- Relevant data used to design the maintenance and origin of these data (return of experience).
- Tests, investigations and calculations carried out to design the maintenance.

#### 4.5.3. *Maintenance description file*

The maintenance description file describes how maintenance activities can be conducted. Maintenance activities include, among others, inspections, monitoring, tests, measurements, replacements, adjustments and repairs.

Maintenance activities are split into:

- preventive ~~maintenance~~([maintenance](#) (scheduled and controlled)), and
- corrective maintenance.

The maintenance description file includes the following:

- Component hierarchy and functional description which sets up the boundaries of the rolling stock by listing all the items belonging to the product structure of that rolling stock and using an appropriate number of discrete levels. The lowest item of the hierarchy shall be a replaceable component.
- Parts list which shall contain the technical and functional descriptions of the spare parts (replaceable units). The list shall include all parts specified for changing based on condition, which may require a replacement following electrical or mechanical malfunction or [for](#) which ~~will foreseeable require a~~ replacement [is foreseeable after an following](#) accidental damage.

~~Elements of construction~~

| Interoperability constituents

shall be indicated and referenced to their corresponding declaration of conformity.

- [Safety critical components list: The safety critical components list shall contain the specific servicing, maintenance and servicing/maintenance traceability requirements.](#)
- Limit values for components which are not to be exceeded in service. It is permitted to specify operational restrictions in degraded mode (limit value reached).
- List of reference to the

| European

legal obligations to which components or subsystems are subject.

- -Maintenance plan<sup>30</sup> i.e. the structured set of tasks to perform the maintenance including the activities, procedures and means. The description of this set of tasks includes:
  - (a) Disassembly/assembly instructions drawings necessary for correct assembly/disassembly of replaceable parts.
  - (b) Maintenance criteria.

---

<sup>30</sup>The maintenance plan shall take into account the findings of the ERA Task Force on Freight Maintenance (see "Final report on the activities of the Task Force Freight Wagon Maintenance" published on the ERA website <http://www.era.europa.eu>)

 <b>OTIF</b>	<b>ROLLING STOCK</b> <b>FREIGHT WAGONS</b>		<b>UTP WAG</b> Page 32 of 151
	Status: <b>PROPOSAL</b>	TECH-20005 Annex	Original: EN

- (c) Checks and tests in particular of safety relevant parts; these include visual inspection and non-destructive tests (where appropriate e.g. to detect deficiencies that may impair safety).
  - (d) Tools and materials required to undertake the task.
  - (e) Consumables required to undertake the task.
  - (f) Personal protective safety provision and equipment.
- Necessary tests and procedures to be undertaken after each maintenance operation before re-entry into service of rolling stock.

#### 4.6. Professional competencies

The professional competencies of staff required for

the operational activities relating to train composition and the use of wagons within their limits and conditions of use are set out in section 4.4 Operating Rules of this UTP.<sup>(31)</sup>

the operation and maintenance of units are not covered by this TSI.

#### 4.7. Health and safety conditions

The provisions for health and safety of staff required for the operation and maintenance of units are covered by the essential requirements 1.1.5, 1.3.1, 1.3.2, 2.5.1, 2.6.1 set out in

UTP General Provisions - Essential requirements (UTP GEN-A).

Annex III to Directive [\(EU\) 2016/797](#) ~~2008/57/EC~~.

In particular, the following points of section 4.2 specify provisions for health and safety of staff:

Point 4.2.2.1.1: End coupling

Point 4.2.6.1: Fire safety

Point 4.2.6.2: Protection against electrical hazards. If the unit is fitted with a manual coupling system, a free space for shunters during coupling and uncoupling shall be provided.

All protruding parts deemed a hazard to operational staff shall be clearly indicated and/or fitted with protective devices.

The unit shall be equipped with footsteps and handrails except in those cases it is not intended to be operated with staff on-board, e.g. for shunting.

#### 4.8. Parameters to be recorded in the technical file <sup>32</sup>

The technical file shall contain at least the following parameters:

- Type, position and resiliency of the end coupling
- Load due to dynamic traction forces and compressive forces

<sup>31</sup> Professional competencies of staff required for the maintenance of units are not covered by this UTP, because they are covered by the regulation for the Entity in Charge of Maintenance.

<sup>32</sup> The full title of the section in the WAG TSI in accordance with Commission Regulation (EU) No 1236/2013 is "4.8 Parameters to be recorded in the technical file and European register of authorised types of vehicles".

 <b>OTIF</b>	<b>ROLLING STOCK</b> <b>FREIGHT WAGONS</b>		<b>UTP WAG</b> Page 33 of 151	
	Status: <b>PROPOSAL</b>		TECH-20005 Annex	Original: EN

- Gauge reference profiles to which the unit complies
- Conformity, if any, to target gauge reference profile(s) G1, GA, GB and GC
- Compliance, if any, to gauge lower reference profile(s) G1 and G2
- Mass per axle (tare and fully laden)
- Position of the axles along the unit and number of axles
- Length of the unit
- Maximum design speed Track gauges(s) the unit can be operated on
- Compatibility with train detection systems (track circuits / axle counters / loop equipment)
  - which shall include the data required in section 4.2.3.3 of this UTP
- Compatibility with hot axle box detection systems
- In-service temperature range of the axle bearings
- Nature of the signal which controls the brake (example: pneumatic main brake pipe, electric brake type XXX, ...)
- Characteristics of the control line and of its coupling with other units (main brake pipe diameter, section of the electric cable ...)
- Individual nominal performance of the brake unit, depending on the brake mode, if any (response time, brake force, level of adhesion required, ...)
- Braking distance or brake weight depending on the brake mode, if any.
- thermal load of the brake ~~components—expressed~~components expressed in terms of speed, axle load, gradient and brake distance
- Temperature range and severity level of snow/ice/hail conditions
- Brake weight and maximum gradient of the parking brake (if applicable)
- Ability / inability to be hump shunted
- Presence of footsteps and/or handrails

The rolling stock data that must be recorded in the “European register of authorized types of vehicles (ERATV)” are set out in the Commission Implementing Decision 2011/665/EU of 4 October 2011 on the European register of authorized types of railway vehicles.<sup>33</sup>

#### 4.9. **Route compatibility checks before the use of vehicles**

Railway undertakings shall check all relevant | The parameters of the subsystem “rolling

<sup>33</sup> OJ L 264, 8.10.2011, p.32.

 <b>OTIF</b>	<b>ROLLING STOCK FREIGHT WAGONS</b>		<b>UTP WAG</b> Page 34 of 151
Status: <b>PROPOSAL</b>		TECH-20005 Annex	Original: EN Date: 17.06.2020

parameters of freights wagons to ensure compatibility with the route on which ~~it~~they intends to use the freight wagons.

The parameters shall be those set out in the UTP covering route compatibility checks.

In the absence of UTP provisions, Contracting States should facilitate route compatibility checks by railway undertakings, e.g. by providing the relevant parameters.

These checks shall comply with the provisions laid down in ATMF, in particular those of Article 6 § 2, Article 9 and Article 15a.

stock — freight wagons” to be used by the railway undertaking, for the purpose of route compatibility check, are described in Appendix D1 of Commission Implementing Regulation (EU) 2019/773<sup>34</sup>

## 5. ~~ELEMENTS OF CONSTRUCTION~~ | INTEROPERABILITY CONSTITUENTS

### 5.1. General

Interoperability Constituents, also referred to as “Elements of Construction”, or ~~“ICs”~~, as defined in Article 2(g) of ATMF, Appendix G to the Convention,

Interoperability constituents (ICs), as defined in article 2(~~7~~) of Directive (EU ~~2016/797~~2008/57/EC),

are listed in section 5.3 together with

- their area of use covering parameters of the subsystem and
- the reference to corresponding requirements defined in section 4.2.

Depending on the law applicable in the state concerned, ICs shall be assessed separately or, if no such requirement ~~of~~for separate assessment ~~does not~~exists in the state concerned, the IC may alternatively be assessed as part of the subsystem.

ICs assessed separately shall, as a general rule, be covered by a declaration of conformity or suitability for use by the manufacturer. Time limited exceptions to the obligation of issuing such a declaration for rear-end signals and for brake blocks are indicated below.

<sup>34</sup> Commission Implementing Regulation (EU) 2019/773 of 16 May 2019 on the technical specification for interoperability relating to the operation and traffic management subsystem of the rail system within the European Union and repealing Decision 2012/757/EU (OJ L 139 I, 27.5.2019, p. 5).

 <b>OTIF</b>	<b>ROLLING STOCK FREIGHT WAGONS</b>		<b>UTP WAG</b> Page 35 of 151	
	Status: <b>PROPOSAL</b>		TECH-20005 Annex	Original: EN

Rear-end signals newly manufactured up to 1 January 2015 are not required to be covered by a declaration of conformity or suitability for use by the manufacturer. For Elements of Construction which are assessed separately from the subsystem in accordance with section 5.1 of this UTP: after a transitional period of one year from 1 January 2014, all newly produced and separately assessed ICs, “rear-end signal”, shall be covered by the required declaration of conformity and/or suitability for use.

Notwithstanding the provisions in section 6.3, the following transitional provisions apply to Elements of Construction corresponding to a “friction element for wheel tread brakes” (further referred to in this paragraph as brake block) which are assessed separately from the subsystem:

brake blocks which are not covered by a declaration of conformity or suitability for use by the manufacturer not certified in accordance with this UTP may be used on new, renewed or upgraded wagons if the type of brake block has already been used on a wagon which was admitted to international traffic in accordance with the UTPs, or authorised in at least one Member State of the EU, either before 1.7.2015, or before the expiry of the brake block’s approval period under the following conditions:

- If the brake block was manufactured before 1.7.2015, it may be used until 30.6.2025.
- If the brake block was manufactured from 1.7.2015 onwards and its approval period had not expired when it was produced, it may be used up to 10 years after the expiry of its approval period.

The production, upgrade or renewal of the wagon shall be completed, including its

<sup>(35)</sup> After a transition period ending on 1 January 2015 ~~of one year following the entry into force of this Regulation~~, newly produced interoperability constituents of “rear-end signal”, shall be covered by the required EC declaration of conformity.

#### Article 8a<sup>(36)</sup>

1. Notwithstanding the provisions in Section 6.3 of the Annex, an EC certificate of verification may be issued for a subsystem containing components corresponding to the “friction element for wheel tread brakes” interoperability constituent that does not have an EC declaration of conformity during a transition period ending on 1 January 2024 ~~of 10 years after the date of application of this Regulation~~, if the following conditions are met:

- a) the component was manufactured before the date of application of this Regulation; and
- b) the interoperability constituent has been used in a subsystem that had been approved and placed on the market ~~in service~~ in at least one Member State before the date of application of this Regulation.

2. The production, upgrade or renewal of any subsystem using non-certified interoperability constituents shall be completed, including granting authorisation for placing in service on the market ~~of the subsystem~~, before the transition period set out in paragraph 1 expires.

#### Article 8c

1. Notwithstanding the provisions in Section 6.3 of the Annex, an EC certificate of verification may be issued for a subsystem

<sup>35</sup> Article 8(4) of Commission Regulation (EU) No 1236/2013 amending the WAG TSI as lastly amended by Commission Implementing Regulation (EU) 2019/776 of 16 May 2019

<sup>36</sup> Articles 8a and 8c of ~~–~~ Commission Regulation 2015/924 amending the WAG TSI as lastly amended by Commission Implementing Regulation (EU) 2019/776 of 16 May 2019

 <b>OTIF</b>	<b>ROLLING STOCK FREIGHT WAGONS</b>		<b>UTP WAG</b> Page 36 of 151	
Status: <b>PROPOSAL</b>		TECH-20005 Annex	Original: EN	Date: 17.06.2020

admission to international traffic, before these transitional periods expire.

Until the expiry of their current approval period, the brake blocks ~~listed~~[referred to](#) in Appendix G are deemed to comply with this UTP.

If a type or design of “friction element for wheel tread brakes” is assessed separately from the subsystem in accordance with this UTP, the corresponding type- or design examination certificate shall be valid for 10 years. During that period, new components of the same type or design may be used in a unit on the basis of a declaration of conformity that refers to this type or design

*containing components corresponding to the “friction element for wheel tread brakes” interoperability constituent that does not have an EC declaration of conformity during a transition period of 10 years after the expiry of the approval period of the interoperability constituent, if the following conditions are met:*

- a) the component was manufactured before the expiry of the approval period of the interoperability constituent; and*
- b) the interoperability constituent has been used in a subsystem that had been approved and placed ~~in service~~[on the market](#) in at least one Member State before the expiry of its approval period.*

*2. The production, upgrade or renewal of any subsystem using non-certified interoperability constituents shall be completed, including granting authorisation for placing ~~in service of the subsystem~~[on the market](#), before the transition period set out in paragraph 1 expires.*

#### *Article 8b*

*1. Until the expiry of their current approval period, “friction element for wheel tread brakes” interoperability constituents listed in Appendix G of the Annex do not need to be covered by an EC declaration of conformity. During this period, “friction elements for wheel tread brakes” listed in Appendix G of the Annex shall be deemed to be compliant with this Regulation.*

*2. After their current approval period expires, “friction element for wheel tread brakes” interoperability constituents listed in Appendix G of the Annex shall be covered by EC declaration of conformity.*

#### *Article 9a*

*The EC-type or EC design examination certificate for the “friction element for wheel tread brakes” interoperability constituent shall be valid for 10 years. During that period, new constituents of the same type may be placed on the market on the basis of an EC declaration of conformity that refers to this EC-type or EC design*

 <b>OTIF</b>	<b>ROLLING STOCK FREIGHT WAGONS</b>		<b>UTP WAG</b> Page 37 of 151	
Status: <b>PROPOSAL</b>		TECH-20005 Annex	Original: EN	Date: 17.06.2020

examination certificate.

~~An element of construction (IC)~~ ICs shall comply with the technical specifications of this chapter whether it is assessed separately as an IC or it is assessed as an integrated part of a subsystem.

Assessment of ICs separate from the subsystem is not mandatory in the COTIF regulations, but Contracting States or regional organisations<sup>37</sup> may require mandatory separate assessment according to the specification in sections 5.3 and 6.1.2 of this UTP. ~~This possibility is without prejudice to section 6.3.~~<sup>38</sup>

#### **Separate assessment of an IC:**

If the IC is in conformity with this UTP, as evidenced by the manufacturer in the form of a declaration of conformity or suitability for use according to section 6.1.2 of this UTP and chapter 2 of UTP GEN-D<sup>39</sup>, the IC shall be permitted to be used in accordance with its defined area of use, in accordance with section 5.3, in all Contracting States.

#### **Assessment of an IC integrated into a vehicle:**

If the IC is assessed as a part of the subsystem, the assessment procedures for subsystems apply. The requirements are identical to those if the IC were to be assessed separately, i.e. those set out in sections 5.3 and 6.1.2.

When a requirement is identified in section 5.3 as being assessed at IC level, an assessment for the same requirement at subsystem level is not required.

## 5.2. Innovative solutions

As stated in

Sections 6.2.1.3 of ~~the present~~ [this](#) UTP

Article 10a<sup>40</sup>,

<sup>37</sup> In particular, compliance with EU law must be ensured when placing an IC on the market in the European Union.

<sup>38</sup> ~~6.3 permits, during a transitional period, the use of ICs produced before 1 January 2014.~~

<sup>39</sup> ~~A 94-01D/3-2014~~

<sup>40</sup> Article 10a of the Commission Regulation (EU) 2015/924 amending the WAG TSI ~~as lastly amended by~~ [Commission Implementing Regulation \(EU\) 2019/776 of 16 May 2019](#)



 <b>OTIF</b>	<b>ROLLING STOCK</b> <b>FREIGHT WAGONS</b>		<b>UTP WAG</b> Page 38 of 151	
	Status: <b>PROPOSAL</b>		TECH-20005 Annex	Original: EN

innovative solutions may require new specifications and/or new assessment methods. Such specifications and assessment methods shall be developed using the process described in point 6.4.2.3 whenever an innovative solution is envisaged for an IC.

### 5.3. IC specifications

#### 5.3.1. Running gear

The running gear shall be designed for all application ranges, the areas of use, as defined by the following parameters:

- Track gauge
- Maximum speed
- Maximum cant deficiency
- Minimum tare of the unit
- Maximum axle load
- Range of distances between bogie pivots or range of wheelbase of “two-axle units”
- Maximum height of centre of gravity of empty unit
- Coefficient of height of centre of gravity of loaded unit minimum torsional stiffness coefficient of car body
- Maximum mass distribution ~~coefficient for~~coefficient for empty units with:

$$\frac{1}{2a^*} \cdot \sqrt{\frac{I_z}{m}}$$

$I_z$  moment of inertia of the car body relative to the vertical axis through the centre of gravity of the car body

$m$  mass of the car body

$2a^*$  wheelbase

- Minimum nominal wheel diameter
- Rail inclination

The parameters speed and axle load may be considered in combination in order to define the appropriate area of use (e.g. maximum speed and tare weight).

The running gear shall comply with the requirements expressed in points 4.2.3.5.2 and 4.2.3.6.1. These requirements shall be assessed at IC level.

#### 5.3.2. Wheelset

For the purpose of this UTP, wheelsets include the main parts ensuring the mechanical interface with the track (wheels and connecting elements: e.g. transverse axle, independent wheel axle). Accessory ~~ies~~ parts (axle bearings, axle boxes and brake discs) are assessed at subsystem level.

The wheelset shall be assessed and designed for the area of use as defined by:

- track gauge,
- nominal wheel tread diameter and
- maximum vertical static force.

 <b>OTIF</b>	<b>ROLLING STOCK</b> <b>FREIGHT WAGONS</b>		<b>UTP WAG</b> Page 39 of 151
	Status: <b>PROPOSAL</b>	TECH-20005 Annex	Original: EN

A wheelset shall comply with the requirements on geometrical and mechanical parameters defined in point 4.2.3.6.2. These requirements shall be assessed at IC level.

### 5.3.3. *Wheel*

A wheel shall be designed and assessed for an area of use defined by

- nominal tread diameter,
- maximum vertical static force,
- maximum speed,
- in-and-service life, limits, and
- maximum braking energy.

A wheel shall comply with the requirements on geometrical, mechanical and thermo mechanical parameters defined in point 4.2.3.6.3. These requirements shall be assessed at IC level.

### 5.3.4. *Axle*

An axle shall be designed and assessed for an area of use defined by

- maximum vertical static force.

An axle shall comply with the requirements on mechanical parameters defined in point 4.2.3.6.4. These requirements shall be assessed at IC level.

#### 5.3.4a. *Friction elements for wheel tread brakes*

Friction element for wheel tread brakes. The friction element for wheel tread brakes shall be designed and assessed for an area of use defined by:

- dynamic friction coefficients and their tolerance bands,
- minimum static friction coefficient,
- maximum permitted brake forces applied on the element,
- suitability for train detection by systems based on track circuits,
- suitability for severe environmental conditions.

A friction element for wheel tread brakes shall comply with the requirements defined in point 4.2.4.3.5. These requirements shall be assessed at IC level.

#### 5.3.4b. *Automatic variable gauge system*

An IC “automatic variable gauge system” shall be designed and assessed for an area of use defined by:

- the track gauges the system is designed for,
- the range of maximum static axle loads,
- the range of nominal wheel tread diameters,
- the maximum design speed of the unit, and
- the types of track gauge changeover facility(ies) the system is designed for, including the nominal speed through the track changeover facility(ies) and the maximum axial forces during the automatic gauge changeover process.

An automatic variable gauge system shall comply with the requirements set out in point 4.2.3.6.6; these requirements shall be assessed at IC level as set out in point 6.1.2.6.

 <b>OTIF</b>	<b>ROLLING STOCK</b> <b>FREIGHT WAGONS</b>		<b>UTP WAG</b> Page 40 of 151	
	Status: <b>PROPOSAL</b>		TECH-20005 Annex	Original: EN

### 5.3.5. Rear-end signal

The rear-end signal, as described in Appendix E, is an independent IC. There are no requirements in section 4.2 dealing with the rear-end signal. ~~Its assessment by the~~

~~Assessing Entity is not part of the conformity assessment~~

Its assessment by the notified body is not part of the EC verification of the subsystem.

~~of the subsystem.~~

## 6. CONFORMITY ASSESSMENT AND VERIFICATION

### 6.1. ~~Elements of Construction (IC)~~ ———— | **Interoperability constituent (IC)**

#### 6.1.1. Modules

The conformity assessment of an IC shall be performed in accordance with the module(s) described in table 8.

Table 8

	<b>Assessment procedures for the verification of elements of construction <u>ICs</u></b>	<b>Modules for conformity assessment of interoperability constituents</b>
Module CA1	Internal production control plus product verification by individual examination	
Module CA2	Internal production control plus product verification at random intervals	
Module CB	Type examination	
Module CD	Conformity to type based on quality management system of the production process	
Module CF	Conformity to type based on product verification	
Module CH	Conformity based on full quality management system	
Module CH1	Conformity based on full quality management system plus design examination	
Module CV	Type validation by in-service experience (suitability for use)	

These modules are specified in detail in

UTP GEN-D General Provisions –  
Assessment Procedures (Modules).

the Commission Decision 2010/713/EU.

#### 6.1.2. Conformity Assessment procedures

In accordance with UTP GEN-D, Contracting States may require the mandatory separate assessment of ICs. If not required by the Contracting State, separate assessment of ICs may be carried out on a voluntary basis.

The manufacturer or his authorised representative established within the Union shall

In case of conformity assessment of an IC as

 <b>OTIF</b>	<b>ROLLING STOCK</b> <b>FREIGHT WAGONS</b>		<b>UTP WAG</b> Page 41 of 151	
	Status: <b>PROPOSAL</b>		TECH-20005 Annex	Original: EN

part of the subsystem, the compliance of the IC with the applicable provisions is verified by applying the modules for subsystem in accordance with section 6.2 of this UTP.

ICs for which module CV applies shall be assessed separately from the subsystem.

In the case of separate IC assessment, the manufacturer bears full responsibility for the UTP compliance of the product within its specified area of use.

In the case of separate IC assessment, the manufacturer shall

choose one of the modules or module combinations indicated in table 9 in accordance with the required IC.

~~element of construction.~~

~~constituent.~~

Table 9

**Assessment procedures for the verification — of elements of construction ICs**  
**Modules to be applied for interoperability constituents**

Point	Constituent	Modules					
		CA1 or CA2	CB+CD	CB+CF	CH	CH1	CV
4.2.3.6.1	Running gear		X	X		X	
	Running gear - established	X			X		
4.2.3.6.2	Wheelset	X <sup>(*)</sup>	X	X	X <sup>(*)</sup>	X	
4.2.3.6.3	Wheel	X <sup>(*)</sup>	X	X	X <sup>(*)</sup>	X	
4.2.3.6.4	Axle	X <sup>(*)</sup>	X	X	X <sup>(*)</sup>	X	
<a href="#">4.2.3.6.6</a>	<a href="#">Automatic variable gauge system</a>	<a href="#">X<sup>(*)</sup></a>	<a href="#">X</a>	<a href="#">X</a>	<a href="#">X<sup>(*)</sup></a>	<a href="#">X</a>	<a href="#">X<sup>(**)</sup></a>
4.2.4.3.5	Friction elements for wheel tread brakes	X <sup>(*)</sup>	X	X	X <sup>(*)</sup>	X	X <sup>(**)</sup>
5.3.5	Rear-end signal	X			X		

<sup>(\*)</sup> Modules CA1, CA2 or CH may be used only in the case of products placed on the market, and therefore developed, before

1 January 2014,

the entry into force of this TSI,

provided that the manufacturer demonstrates to the

Assessing Entity

NoBo

 <b>OTIF</b>	<b>ROLLING STOCK FREIGHT WAGONS</b>		<b>UTP WAG</b> Page 42 of 151	
	Status: <b>PROPOSAL</b>		TECH-20005 Annex	Original: EN

that design review and type examination were performed for previous applications under comparable conditions, and are in conformity with the requirements of this [UTP](#);

~~UTP;~~

~~TSI;~~

this demonstration shall be documented, and is considered as providing the same level of proof as module CB or design examination according to module CH1.

(\*\*) Module CV shall be used in case the manufacturer of friction element for wheel tread brakes has no sufficient return of experience (according to its own judgment) for the proposed design.

Within the application of the chosen module or module combination the [interoperability constituent](#)

~~element of construction~~

~~interoperability constituent~~

shall be assessed against the requirements mentioned in section 4.2. If necessary, additional requirements concerning the assessment of particular [interoperability constituents](#)

~~element of construction~~

~~interoperability constituent~~

are given in the following clauses.

~~In case of~~For a specific case applicable to a component defined as an [interoperability constituent](#) in section 5.3, the corresponding requirement can be part of the verification at [interoperability constituent level only](#) ~~in the case where~~if the component remains compliant ~~to the~~with chapters 4 and 5 and where the specific case does not refer to

~~a national technical requirement.~~

~~a national rule (i.e. additional requirement compatible with the core TSI and fully specified in the TSI).~~

~~In other cases, the verification shall be made at subsystem level; when a national rule applies to a component, the concerned~~Contracting State concerned may define relevant applicable [conformity assessment procedures](#)

#### 6.1.2.1. Running gear

The demonstration of conformity for ~~the~~running [dynamic behaviour gear](#) is set out in [EN 16235:2013](#).

~~Appendix B section 2.~~

~~in chapter 2 of ERA technical document ERA/TD/2013/01/INT version 1.0 of 11.02.2013 published on the ERA website (<http://www.era.europa.eu>).~~

Units equipped with an established running gear as ~~listed below~~[described in chapter 6 of EN 16235:2013](#) are presumed to be in conformity with the relevant requirement provided that the running gears are operated within their established area of use.:

(a) ~~Single axle running gear:~~

~~—— Double link suspension.~~

~~—— Niesky 2.~~

 <b>OTIF</b>	<b>ROLLING STOCK</b> <b>FREIGHT WAGONS</b>		<b>UTP WAG</b> Page 43 of 151	
	Status: <b>PROPOSAL</b>		TECH-20005 Annex	Original: EN

- ~~— Suspension S 2000.~~
- (b) ~~— Two axle bogie running gear:~~
- ~~— Y25 family.~~
- ~~— Two axle steering axle bogie.~~
- (c) ~~— Three axle bogies:~~
- ~~— Three axle bogie family with link suspension.~~

The assessment of the bogie frame strength shall be based on clause 6.2 of EN 13749:2011.

#### 6.1.2.2. Wheelset

The demonstration of conformity for the mechanical behaviour of the wheelset assembly shall be carried out according to clause 3.2.1 of EN13260:2009+A1:2010, which defines limit values for the axial assembly force and the associated verification test.

Alternative demonstration of conformity is allowed in accordance with point 6.1.2.4a.

[text in accordance with Opinion OPI 2019-1 of the European Union Agency for Railways for the European Commission regarding WAG TSI 321-2013 potential deficiency - innovative bogies]

A verification procedure shall exist to ensure at the assembly phase that no defects may detrimentally affect safety due to any change in the mechanical characteristics of the fitted parts of the axle. This procedure shall contain the determination of the interference values and, in case of press-fitted wheelsets, the corresponding press-fitting diagram.

#### 6.1.2.3. Wheel

- (a) Forged and rolled wheels: The mechanical characteristics shall be proven following the procedure as specified in clause 7 of EN 13979-1:2003+A1:2009+A2:2011.

If the wheel is intended to be used with brake blocks acting on the wheel running surface, the wheel shall be thermo-mechanically proven by taking into account the maximum braking energy foreseen. A type test, as described in clause 6.2 of EN 13979-1:2003+A1:2009+A2:2011 shall be performed in order to check that the lateral displacement of the rim during braking and the residual stress are within the specified tolerance limits.

The decision criteria of residual stresses for forged and rolled wheels are set out in EN 13979-1:2003+A1:2009+A2:2011.

Alternative demonstration of conformity is allowed in accordance with point 6.1.2.4a.

[text in accordance with Opinion OPI 2019-1 of the European Union Agency for Railways for the European Commission regarding WAG TSI 321-2013 potential deficiency - innovative bogies]

- (b) Other types of wheels: Other types of wheels are permitted for units in national use. In that case the decision criteria and the fatigue stress criteria shall be specified in national rules.

Such national rules may only be

Those national rules shall be notified by

 <b>OTIF</b>	<b>ROLLING STOCK</b> <b>FREIGHT WAGONS</b>		<b>UTP WAG</b> Page 44 of 151	
	Status: <b>PROPOSAL</b>		TECH-20005 Annex	Original: EN

applied to international traffic when they are in force in accordance with Article 12 of APTU, Appendix F to the Convention.

Member States in accordance with Article ~~147(3)~~ of Directive (EU) ~~2016/797~~~~2008/57/EC~~.

A verification procedure shall exist to ensure at the production phase that no defects may detrimentally affect safety due to any change in the mechanical characteristics of the wheels. The tensile strength of the material in the wheel, the hardness in the rim, the fracture toughness (only for tread-braked wheels), resistance to impact, the material characteristics and the material cleanliness shall be verified. The verification procedure shall specify the batch sampling used for each characteristic to be verified.

#### 6.1.2.4. Axle

In addition to the requirement on the assembly above, the demonstration of conformity of mechanical resistance and fatigue characteristics of the axle shall be based on clauses 4, 5 and 6 of EN13103:2009+A2:2012.

The decision criteria for the permissible stress are specified in clause 7 of EN 13103:2009+A2:2012. A verification procedure shall exist to ensure at the production phase that no defects may detrimentally affect safety due to any change in the mechanical characteristics of the axles. The tensile strength of the material in the axle, the resistance to impact, the surface integrity, the material characteristics and the material cleanliness shall be verified. The verification procedure shall specify the batch sampling used for each characteristic to be verified.

[Alternative demonstration of conformity is allowed in accordance with point 6.1.2.4a.](#)

[\[text in accordance with Opinion OPI 2019-1 of the European Union Agency for Railways for the European Commission regarding WAG TSI 321-2013 potential deficiency - innovative bogies\]](#)

#### [6.1.2.4a Alternative assessment procedure applicable to wheelsets, wheels and axles](#)

[It is permitted to use other standards where the EN standards referred to in points 6.1.2.2, 6.1.2.3 and 6.1.2.4 do not cover the proposed technical solution; in that case the assessing entity shall verify that the alternative standards form part of a technically consistent set of standards applicable to the design, construction and testing of the wheelsets, containing specific requirements for wheelset, wheels and axles covering:](#)

- [— wheelset assembly,](#)
- [— mechanical resistance,](#)
- [— fatigue characteristics,](#)
- [— permissible stress limits,](#)
- [— thermomechanical characteristics.](#)

[Only standards that are publicly available can be referred to in the demonstration required](#)

[\[text in accordance with Opinion OPI 2019-1 of the European Union Agency for Railways for the European Commission regarding WAG TSI 321-2013 potential deficiency - innovative bogies\]](#)

 <b>OTIF</b>	<b>ROLLING STOCK FREIGHT WAGONS</b>		<b>UTP WAG</b> Page 45 of 151	
Status: <b>PROPOSAL</b>		TECH-20005 Annex	Original: EN	Date: 17.06.2020

above. The verification carried out by the assessing entity ~~notified body~~ shall ensure the consistency between the methodology of the alternative standards, the assumptions taken by the applicant, the intended technical solution and the intended area of use.

#### 6.1.2.5. Friction elements for wheel tread brakes

The demonstration of conformity of friction elements for wheel tread brakes shall be carried out by determining the following friction element properties in accordance with

Appendix O:

the European Railway Agency (ERA) technical document ERA/TD/2013-02/INT version 23.0 of 27.11.2015 ~~XX.XX.2014~~ published on the ERA website (<http://www.era.europa.eu>):

- dynamic friction performance (chapter 4);
- static friction coefficient (chapter 5);
- mechanical characteristics including properties in respect to shear strength test and flexural strength test (chapter 6).

Demonstration of the following suitabilities shall be carried out in accordance with chapters 7 and/or 8 of

Appendix O,

the ERA technical document ERA/TD/2013-02/INT version 23.0 of 27.11.2015 ~~XX.XX.2014~~ published on the ERA website (<http://www.era.europa.eu>),

if the friction element is intended to be suitable for:

- train detection by systems based on track circuits; and/or
- severe environmental conditions.

If a manufacturer does not have sufficient return of experience (according with its own judgement) for the proposed design, the type validation by in-service experience procedure (module CV) shall be part of the assessment procedure for suitability for use. Before commencing in-service tests, a suitable module (CB or CH1) shall be used to certify the design of the interoperability constituent.

The in-service tests shall be organised on request from the manufacturer, who must obtain agreement from a railway undertaking that will contribute to such an assessment.

The suitability for train detection by systems based on track circuits for friction elements intended to be used in subsystems beyond the scope set out in chapters 7 of

Appendix O,

the ERA technical document ERA/TD/2013-02/INT version 23.0 of 27.11.2015 ~~XX.XX.2014~~ published on the ERA website (<http://www.era.europa.eu>),



 <b>OTIF</b>	<b>ROLLING STOCK</b> <b>FREIGHT WAGONS</b>		<b>UTP WAG</b> Page 46 of 151	
	Status: <b>PROPOSAL</b>		TECH-20005 Annex	Original: EN

may be demonstrated using the procedure for innovative solutions described in point 6.1.3.

The suitability for severe environmental conditions by a dynamometer test for friction elements intended to be used in subsystems beyond the scope set out in clause 8.2.1 of

Appendix O,

the ERA technical document ERA/TD/2013-02/INT version ~~2~~3.0 of [27.11.2015](#) ~~XX.XX.2014~~ published on the ERA website (<http://www.era.europa.eu>),

may be demonstrated using the procedure for innovative solutions described in point 6.1.3.

#### 6.1.2.6. Automatic variable gauge system

The assessment procedure shall be based on a validation plan covering all aspects mentioned in points 4.2.3.6.6 and 5.3.4b.

The validation plan shall be consistent with the safety analysis required in point 4.2.3.6.6 and shall define the assessment needed in all the following different phases:

- Design review
- Static tests (bench tests and integration-in-the-wheelset/unit tests)
- Test on track gauge changeover facility(ies), representative of in-service conditions
- On-track tests, representative of in-service conditions.

Regarding the demonstration of compliance to the safety level required in point 4.2.3.6.6, the assumptions considered for the safety analysis related to the unit the system is intended to be integrated in, and related to the mission profile of that unit, shall be clearly documented.

The automatic variable gauge system may be subject to an assessment of suitability for use (module CV). Before commencing in-service tests, a suitable module (CB or CH1) shall be used to certify the design of the interoperability constituent. The in-service tests shall be organised on request from the manufacturer, who must obtain an agreement from a railway undertaking for its contribution to such assessment.

The certificate issued by the assessing entity in charge of the conformity assessment shall include both the conditions for use as per point 5.3.4b and the type(s) and operating conditions of the track gauge changeover facility(ies) the automatic variable gauge system has been assessed for.

#### 6.1.3. *Innovative solutions*

If an innovative solution referred to in

~~Point 6.2.3 is proposed for an element of construction;~~

~~referred to in Article 10a is proposed for an interoperability constituent;~~

is proposed for an interoperability constituent, the manufacturer or his authorised representative

established within the Union

shall apply

mutatis mutandis the procedure set out in ~~point~~ clause 6.2.3 ~~of this UTP.~~

the procedure set out in Article 10a.

 <b>OTIF</b>	<b>ROLLING STOCK FREIGHT WAGONS</b>		<b>UTP WAG</b> Page 47 of 151
	Status: <b>PROPOSAL</b>	TECH-20005 Annex	Original: EN

## 6.2. Subsystem

### 6.2.1. Modules

For requirements applicable to the functional subsystems<sup>41</sup>, conformity with the requirement shall be ensured during operation. Assessment of the functional parts is not included in the tasks of the Assessing Entity. The

The EC

verification of the subsystem “Rolling stock – freight wagons” shall be performed in accordance with the module(s) described in table 10.

Table 10

**Assessment procedures for the verification of subsystems**

**Modules for EC verification of subsystems**

(OTIF) Type examination	SB	EC-Type Examination
Quality management system of the production process	SD	EC verification based on quality management system of the production process
Verification based of product verification	SF	EC verification based on product verification
Verification based on full quality management system plus design examination	SH1	EC verification based on full quality management system plus design examination

These modules are specified in detail in

APTU Uniform Rules, Appendix F to COTIF 1999 - UTP GEN-D

the Decision 2010/713/EU.

### 6.2.2. Verification procedures

***EC verification procedures***

The applicant shall choose one of the following combinations of modules or module for the

<sup>41</sup> This UTP contains requirements applicable to two functional subsystems in accordance with UTP GEN-B; the first being Operation and traffic management, the second being maintenance. The requirements related to the function subsystem concern (part of the) sections 4.2.3.6.4, 4.3.2, 4.4, 4.5.1, 4.6 and UTP Marking, which apply to the use of freight wagons.

 <b>OTIF</b>	<b>ROLLING STOCK</b> <b>FREIGHT WAGONS</b>		<b>UTP WAG</b> Page 48 of 151	
	Status: <b>PROPOSAL</b>		TECH-20005 Annex	Original: EN

EC

verification of the subsystem.

- (SB+SD) or
- (SB+SF) or
- (SH1).

Within the application of the chosen module or module combination the subsystem shall be assessed against the requirements mentioned in section 4.2. If necessary, additional requirements concerning the assessment of particular constituents are given in the following clauses.

#### 6.2.2.1. Strength of unit

The demonstration of conformity shall be in accordance with chapters 6 and 7 of EN 12663-2:2010, or alternatively with chapter 9.2 of EN 12663-1:2010+A1:2014.

Regarding joints, a recognised verification procedure shall exist to ensure at the production phase that no defect may decrease the intended mechanical characteristics of the structure.

#### 6.2.2.2. Safety against derailment running on twisted track

The demonstration of conformity shall be carried out in accordance with chapters 4, 5 and 6.1 of EN 14363:2016. ~~either in accordance with the procedure defined in section 4.1 of EN 14363:2005 or the method given in section 4.2 of EN15839:2012 by using the pre-calculation for standardised solutions.~~

#### 6.2.2.3. Running dynamic behaviour

##### *On-track tests*

The demonstration of conformity shall be carried out in accordance with ~~c~~ chapters 4, 5 and 7 of EN 14363:2016.

For units operated on the 1-668 mm track gauge network, the evaluation of the estimated value for the guiding force normalized to the radius  $R_m = 350$  m according to EN 14363:2016, clause 7.6.3.2.6 (2), shall be calculated according to the following formula:

$$Y_{a,nf,qst} = Y_{a,f,qst} - (11\,550 \text{ m} / R_m - 33) \text{ kN.}$$

The limit value of the quasi-static guiding force  $Y_{j,a,qst}$  shall be 66 kN.

Values of cant deficiency can be adapted to 1-668 mm track gauge by multiplying the corresponding 1-435 mm parameter values by the following conversion factor: 1 733/1 500.

The combination of the highest equivalent conicity and speed for which the unit meets the stability criterion in chapters 4, 5 and 7 of EN 14363:2016 shall be recorded in the report.

~~As an alternative to performing on-track tests on two different rail inclinations, as set out in clause 5.4.4.4 in EN 14363:2005, tests may be carried out on only one rail inclination if it is demonstrated that the tests cover the range of contact conditions as set out in section 1.1. of~~

~~Appendix B.~~

ERA technical document  
ERA/TD/2013/01/INT version 1.0 of  
11.02.2013 published on the ERA website  
(<http://www.era.europa.eu>).

 <b>OTIF</b>	<b>ROLLING STOCK FREIGHT WAGONS</b>		<b>UTP WAG</b> Page 49 of 151	
Status: <b>PROPOSAL</b>		TECH-20005 Annex	Original: EN	Date: 17.06.2020

~~When an on-track test with normal measuring method is required the unit shall be assessed against the limit values set out in~~

~~Appendix B, sections 1.2 and 1.3.~~

sections 1.2 and 1.3 of ERA technical document ERA/TD/2013/01/INT version 1.0 of 11.02.2013 published on the ERA website (<http://www.era.europa.eu>).

~~The combination of the highest equivalent conicity and speed for which the unit meets the stability criterion in clause 5 of EN 14363:2005 shall be recorded in the report.~~

~~The required test conditions for on-track tests, as set out in EN 14363:2005, are not always fully achievable concerning~~

~~—— track geometric quality and~~

~~—— combinations of speed, curvature, cant deficiency.~~

~~In cases this is not fully achievable the demonstration of conformity is an open point.~~

*Simulations*

~~Alternatively, under the conditions stated in section 9.3 of EN 15827:2011, a simulation may replace the above mentioned on-track tests.~~

#### 6.2.2.4. Axle box / bearings

The demonstration of conformity for mechanical resistance and fatigue characteristics of the rolling bearing shall be in accordance with clause 6 of EN12082:2007+A1:2010.

It is permitted to use other standards for the above demonstration of conformity where the EN standards do not cover the proposed technical solution; in that case the assessing entity shall verify that the alternative standards form part of a technically consistent set of standards applicable to the design, construction and testing of the bearings.

Only standards that are publicly available can be referred to in the demonstration required above.

In the case of bearings manufactured according to a design developed and already used

to place products on the market

before the entry into force of relevant UTPs applicable to those products, the applicant is allowed to deviate from the demonstration of conformity above and refer to design review and type examination performed for previous applications under comparable conditions instead; this demonstration shall be documented and is considered to provide the same level of proof as type examination according to module SB or design examination according to module SH1.

#### 6.2.2.4a. Automatic variable gauge systems

The safety analysis required in point 4.2.3.6.6, and performed at IC level, shall be consolidated at the level of the unit; in particular, the assumptions made in accordance with point 6.1.2.6 may need to be reviewed to take into account the unit and its mission profile.

#### 6.2.2.5. Running gear for manual change of wheelsets

*Changeover between 1435 mm and 1668 mm track gauges*

 <b>OTIF</b>	<b>ROLLING STOCK</b> <b>FREIGHT WAGONS</b>		<b>UTP WAG</b> Page 50 of 151
	Status: <b>PROPOSAL</b>	TECH-20005 Annex	Original: EN

The technical solutions described in the following figures of the UIC leaflet 430-1:2012 are deemed to be compliant with the requirements in point 4.2.3.6.7:

- for axle units: figures 9 and 10 of Annex B.4, and figure 18 of Annex H of UIC leaflet 430-1:2012,
- for bogie units: figure 18 of Annex H [and figures 19 and 20 of Annex I](#) of UIC leaflet 430-1:2012.

#### *Changeover between 1435 mm and 1524 mm track gauges*

The technical solution described in Appendix 7 of UIC leaflet 430-3:1995 is deemed to be compliant with the requirements in point 4.2.3.6.7.

#### 6.2.2.6. Thermal capacity

Calculations, simulations or tests shall demonstrate that the temperature of the brake block, brake pad or brake disc does not exceed their thermal capacity. The following shall be taken into account:

- (a) Concerning the emergency brake application: the critical combination of speed and payload considering straight and level track, minimum wind and dry rails
- (b) Concerning the continuous brake application:
  - the range up to the maximum braking power,
  - the range up to the maximum speed and
  - the corresponding brake application time.

#### 6.2.2.7. Environmental conditions

Steel materials are deemed to comply with all the ranges indicated in point 4.2.5 if the material properties are determined down to -20°C.

#### 6.2.2.8. Fire safety

##### 6.2.2.8.1. Barriers

Barriers shall be tested in accordance with EN1363-1:~~1999~~[2012](#). Steel sheets of at least 2 mm thickness and aluminium sheets of at least 5 mm thickness are deemed to comply with the integrity requirements without testing.

##### 6.2.2.8.2. Materials

Testing of the materials ignitability and flame spread properties shall be performed in accordance with ISO 5658-2:2006/Am1:2011 for which the limit value shall be  $CFE \geq 18$  kW/m<sup>2</sup>.

[For rubber parts of bogies, the testing shall be performed in accordance with ISO 5660-1:2015 for which the limit value shall be  \$MARHE \leq 90\$  kW/m<sup>2</sup> under the test conditions specified in reference T03.02 of Table 6 of EN 45545-2:2013+A1:2015.](#)

For the following materials and components, the fire safety requirements are deemed to comply with the required ignitability and flame spread properties:

- [Wheelsets, coated or uncoated.](#)
- Metals and alloys with inorganic coatings (such as, but not limited to: galvanized coating, anodic coating, chromate film, phosphate conversion coating).
- Metals and alloys with an organic coating with a nominal thickness less than 0.3 mm (such as, but not limited to paints, plastic coating, asphaltic coating).

 <b>OTIF</b>	<b>ROLLING STOCK FREIGHT WAGONS</b>		<b>UTP WAG</b> Page 51 of 151
	Status: <b>PROPOSAL</b>	TECH-20005 Annex	Original: EN

- Metals and alloys with a combined inorganic and organic coating of which the nominal thickness of the organic layer is less than 0.3 mm.
- Glass, stoneware, ceramic and natural stone products.
- Materials that meet the requirements of category C-s3, d2 or higher in accordance with EN 13501-1:2007+A1:2009.

#### 6.2.2.8.3 Cables

The electrical cables shall be selected and installed in accordance with EN 50355:2001<sup>13</sup> and EN 50343:2003<sup>14</sup>.

#### 6.2.2.8.4 Flammable liquids

The measures taken shall be in accordance with ~~TS-EN~~ 45545-7:2009<sup>13</sup>.

#### 6.2.3. *Innovative solutions*

If an innovative solution

referred to in Article 10a

is proposed for the “Rolling stock – freight wagons” subsystem, the applicant shall apply the procedure set out

below:

in Article 10a <sup>42</sup>

In order to keep pace with technological progress, innovative solutions may be required that do not comply with the specifications set out in this UTP or for which the assessment methods set out in this UTP cannot be applied. In that case, new specifications and/or new assessment methods associated with those innovative solutions shall be developed.

~~2.~~—Innovative solutions may be related to the “rolling stock — freight wagons” subsystem, its parts and its elements of construction.

~~3.~~—If an innovative solution is proposed, the manufacturer or his authorised representative shall declare how it intends to deviate from or complements the relevant provisions of this UTP. On the basis of this declaration, one of the entities listed in Article 6 § 2 of APTU, or the Secretary General may and shall submit the new specifications and/or new assessment methods~~deviations~~ to the ~~Secretary General~~Committee of Technical Experts

<sup>42</sup> Article 10a of the Commission Regulation (EU) 2015/924 amending the WAG TSI as lastly amended by Commission Implementing Regulation (EU) 2019/776 of 16 May 2019

 <b>OTIF</b>	<b>ROLLING STOCK FREIGHT WAGONS</b>		<b>UTP WAG</b> Page 52 of 151	
Status: <b>PROPOSAL</b>		TECH-20005 Annex	Original: EN	Date: 17.06.2020

(CTE) for analysis and approval.

~~The Secretary General will coordinate its opinion with the EU and the European Railway Agency on the proposed innovative solution and submit its opinion to the Committee of Technical Experts (CTE).~~

4.——If the CTE supports the new specifications and/or new assessment methods~~opinion~~, the appropriate functional and interface specifications—~~and the assessment method~~, which must be included in the UTP- in order to allow the use of this innovative solution, shall be developed ~~in coordination with the EU~~ and subsequently integrated in the UTP during ~~the~~its revision process.

5.——Pending the revision of the UTP, the Committee of Technical Experts may already ~~positive CTE opinion shall be~~ considered the new specifications and/or new assessment methods as an acceptable means of compliance with the essential requirements of UTP GEN-A ~~and may therefore be used for the assessment of the subsystem~~. In such case the Committee of Technical Experts shall instruct the Secretary General as to how the new specifications and/or new assessment methods shall be communicated to the Contracting States and be made public.

### 6.3. **Subsystem containing components corresponding to an interoperability constituents not holding an EC declaration**

[reserved] ~~An Assessing Entity~~

A Notified Body is permitted to issue an EC certificate of verification of a subsystem, even if one or more of the components corresponding to interoperability constituents incorporated within the subsystem are not covered by a relevant EC declaration of conformity in accordance with this TSI (non-certified ICs) if the constituent was manufactured before the entry into force of this TSI and the type of constituent has been

- used in a subsystem already approved, and
- placed in service in at least one

 <b>OTIF</b>	<b>ROLLING STOCK FREIGHT WAGONS</b>		<b>UTP WAG</b> Page 53 of 151	
Status: <b>PROPOSAL</b>		TECH-20005 Annex	Original: EN	Date: 17.06.2020

Member State before the entry in force of this TSI.

The EC verification of the subsystem shall be carried out by the Notified Body against the requirements of Chapter 4 by using the corresponding requirements concerning assessment in Chapter 6 together with Chapter 7 except for specific cases. For this verification the modules of the subsystem, set out in point 6.2.2, apply.

EC declarations of conformity or suitability for use shall not be drawn up for the components assessed in this manner.

~~a UTP Certificate of verification~~

~~elements of construction~~

~~declaration of conformity for ICs in accordance with this UTP<sup>43</sup>. Such non-certified ICs are permitted to be used if the element of construction~~

~~1 January 2014~~

~~Contracting State before 1 January 2014.~~

~~Verification of the subsystem shall be carried out by the Assessing Entity~~

#### 6.4. Project phases where assessment is required

The assessment shall cover the following two phases as identified by “X” in the table F.1 of Appendix F ~~in this~~.

<sup>43</sup>~~The separate assessment and certification of ICs from the subsystem is generally not mandatory in COTIF, however CSs may require separate assessment. For non-certified ICs as described in this clause, CSs may not require separate assessment.~~



 <b>OTIF</b>	<b>ROLLING STOCK FREIGHT WAGONS</b>		<b>UTP WAG</b> Page 54 of 151
	Status: <b>PROPOSAL</b>	TECH-20005 Annex	Original: EN

**UTP**

**TSI**

In particular, where a type test is identified the conditions and requirements of section 4.2 shall be considered.

- (a) Design and development phase:
  - Design review and/or design examination
  - Type test: test to verify the design, if and as defined in the section 4.2.
- (b) Production phase:
  - Routine test to verify the conformity of production. The entity in charge of the assessment of the routine tests is determined according to the assessment module chosen.

Appendix F is structured according to section 4.2. Where relevant, a reference to the points of sections 6.1 and 6.2 is given.

6.5. **Elements of construction ICs holding a declaration of conformity**

**Constituents holding an EC declaration of conformity**

Where an element has been identified as an IC and held either

Where a constituent an EC declaration of conformity

- a declaration of conformity issued in accordance with [a previous version of the UTP Wagons:2012<sup>44</sup>](#), or
- an EC declaration of conformity issued in accordance with EU regulations equivalent to [a previous version of the UTP Wagons:2012](#),

before [the entry into force of this UTP 1 January 2014](#),

~~the entry into force of this TSI,~~

its treatment under this [UTP](#)

~~UTP~~

~~TSI,~~

is set out as follows:

- (a) In the case this constituent is not recognised as an IC in this [UTP](#)

~~UTP,~~

~~TSI,~~

<sup>44</sup> A 94-02/3.2014

 <b>OTIF</b>	<b>ROLLING STOCK FREIGHT WAGONS</b>		<b>UTP WAG</b> Page 55 of 151
Status: <b>PROPOSAL</b>		TECH-20005 Annex	Original: EN Date: 17.06.2020

neither the certificate nor the declaration are valid for the verification procedure related to this [UTP](#).

~~UTP.~~

~~TSI.~~

(b) The

certificates issued in accordance with [a previous version of the UTP WAG:2012](#), or the equivalent

EC certificates of conformity, EC-type examination certificates and EC-design examination certificates of the following ICs shall remain valid under this [UTP](#)

~~UTP~~

~~TSI~~

until their expiry:

- Wheelset;
- Wheel;
- Axle.

## 7. IMPLEMENTATION

### 7.1. Admission to operation

**Authorisation for placing ~~in-service~~[on the market](#)**

This

UTP

TSI

is applicable to the subsystem “rolling stock - freight wagons” within the scope set out in its sections 1.1, 1.2 and ~~Chapter 2.1~~, which ~~are placed in service after the date of~~

~~1 January 2014~~[are admitted for use in international traffic after the entry into force of this UTP.](#)

[are placed on the market after the date of application of this TSI.](#)

[This UTP is also applicable on a voluntary basis to:](#)

- [units referred to in section 2.1 point \(a\) in transport \(running\) configuration, in case they correspond to a ‘unit’ as defined in this UTP, and](#)
- [units as defined in section 2.1 point \(c\), in case they are in empty configuration.](#)

[In case the applicant chooses to apply this UTP, the corresponding UTP declaration of verification shall be recognised as such by Contracting States.](#)

*Authorisation for placing in service of a new vehicle in conformity with the previous WAG TSIs*

 <b>OTIF</b>	<b>ROLLING STOCK FREIGHT WAGONS</b>		<b>UTP WAG</b> Page 56 of 151
	Status: <b>PROPOSAL</b>	TECH-20005 Annex	Original: EN

7.1.1. *Admission to operation of a new vehicle in conformity with the previous WAG UTP.*

~~See Section 0.~~

A UTP certificate of verification and a UTP declaration of verification of a vehicle<sup>45</sup> which is in conformity with the UTP WAG: 2012<sup>46</sup> shall be valid until the end of a transitional period ~~of three years from 13 April 2013~~ ending on 1 January 2017.

~~This UTP contains open points relating to technical compatibility with the infrastructure, so the conditions for free circulation in accordance with ATMF Article 6 § 3 are not met. For this reason, ATMF Article 6 § 4 applies to wagons meeting the conditions prescribed in sections 4, 5 and 6 of this UTP, but not meeting the conditions of section 7.1.2.~~

~~However, if a vehicle also complies with the conditions prescribed in section 7.1.2 of this UTP, the open points are closed by means of particular technical solutions.~~ Vehicles not subject to a specific case and meeting the conditions prescribed in section 7.1.2 meet the conditions of ATMF Article 3a § 2 and Article 6 § 3.<sup>48</sup> Such a vehicle may circulate in international traffic in accordance with ATMF Article 6 § 3. Compatibility with the infrastructure shall be ensured by the rail transport undertaking under its responsibility in accordance with ATMF Article 6 § 2.

~~See Article 9.~~

~~(<sup>47</sup>)The declaration of verification and/or conformity to type of a new vehicle established in accordance with Decision 2006/861/EC shall be considered valid until the end of a transition period- ending on 1 January 2017 of three years after the entry into force of this Regulation.~~

~~(<sup>49</sup>)~~

*Mutual recognition of the first authorisation of placing ~~in service~~ on the*

<sup>45</sup> The validity of certificates and declarations referred to in this market of admission to operation according to Article 6 of ATN

<sup>46</sup> A 94-02/3.2011

<sup>47</sup> Article 9 of Commission Regulation (EU) No 321/2013 enacting the WAG TSI ~~as lastly amended by~~ Commission Implementing Regulation (EU) 2019/776 of 16 May 2019

~~<sup>48</sup> Such a vehicle may circulate freely in accordance with ATMF Article 6 § 3. Compatibility with the infrastructure is ensured by the rail transport undertaking under its responsibility in accordance with ATMF Article 6 § 2.~~

~~<sup>49</sup> The EU provisions are set out in 2008/57/EC Articles 21 to 25.~~

 <b>OTIF</b>	<b>ROLLING STOCK</b> <b>FREIGHT WAGONS</b>		<b>UTP WAG</b> Page 57 of 151	
	Status: <b>PROPOSAL</b>		TECH-20005 Annex	Original: EN

### 7.1.2. *Mutual recognition of the first admission to operation*

~~Without prejudice to specific cases, vehicles which are admitted~~The admission to operation of a vehicle in a Contracting State and which fully meets the conditions set out in a) to k) section 7.1.2 of this UTP shall be valid in all Contracting States in accordance with Article 6 § 3 of ATMF.~~not be subject to any additional admission to operation in OTIF Contracting States.~~

~~Without prejudice to specific cases, vehicles which are authorised for placing in service in a Contracting State which is also an EU Member State according to Article 22 of Directive 2008/57/EC and which fully meet the conditions set out in section 7.1.2 of TSI WAG:2013 shall not be subject to any additional admission to operation in OTIF Contracting States.~~

~~These conditions~~ in this section shall be seen as complementary to the requirements in section 4.2 and must be fulfilled in their entirety.

~~In accordance with Article 23(1) of Directive 2008/57/EC the following list lays out the conditions under which a unit, once authorised for placing in service in one Member State, shall not be subject to any additional authorisation for placing in service. These conditions shall be seen as complementary to the requirements in section 4.2. These following conditions must be fulfilled in their entirety:~~

In accordance with Article 21(3)(b) of Directive (EU) 2016/797 the authorisation for placing on the market of a vehicle (as defined in this TSI) is granted on the basis of:

- in accordance with point (a) of Article 21(3): the ‘EC’ declaration of verification as provided for in Article 15 of the same directive, and
- in accordance with (d) of Article 21(3): evidence of the technical compatibility of the unit with the network in the area of use covering the EU network.

Points (b) and (c) of Article 21(3) of Directive (EU) 2016/797 do not represent any additional requirement. The technical compatibility of the vehicle with the network being covered by rules (TSIs or national rules), this aspect is also considered at the level of the ‘EC’ verification.

Therefore, the conditions for having an area of use not limited to particular national networks are specified below as additional requirements to be covered in the EC verification of the subsystem rolling stock. These conditions shall be seen as complementary to the requirements in Section 4.2 and must be fulfilled in their entirety:

- ~~a) — The running dynamic behaviour of the unit must have been assessed to the full range of track geometric qualities and all combinations of speed, curvature, cant deficiency set out in EN 14363:2005 (point 4.2.3.5.2). Alternatively the unit must be equipped with running gear, either certified or established, in accordance with point 6.1.2.1.~~

 <b>OTIF</b>	<b>ROLLING STOCK</b> <b>FREIGHT WAGONS</b>		<b>UTP WAG</b> Page 58 of 151	
	Status: <b>PROPOSAL</b>		TECH-20005 Annex	Original: EN

~~b) The axle bearing condition must be possible to be monitored by line side detection equipment of the network the unit is intended to be operated on considering the conditions of clauses 4.2.3.4.~~

~~e) The unit must not be equipped with variable gauge wheelsets (point 4.2.3.6.6).~~

~~d)a)~~ The unit must be equipped with forged and rolled wheels assessed according to point 6.1.2.3 (a).

~~e)b)~~ The compliance/non-compliance with the requirements regarding the axle bearing condition monitoring by line side equipment as set out in point 7.3.2.2. (a) must be recorded in the technical file.

~~f) Units intended to operate on the 1668 mm track gauge network must comply with the requirements regarding the axle bearing condition monitoring by line side equipment as set out in point 7.3.2.2 b).~~

~~g)c)~~ The reference profile established for the unit as per point 4.2.3.1 must be allocated to one of the target reference profile(s) G1, GA, GB and GC including those used for the lower part G1E and G1E2.

~~h)d)~~ The unit must be compatible with the train detection systems based on track circuits, on axle counters and on loop equipment

where the values of the parameters set out in clauses 4.2.3.3(a), 4.2.3.3(b) and 4.2.3.3(c) shall be as defined in Appendix H of this UTP.

as specified in clauses 4.2.3.3(a) and 4.2.3.3(b) and 4.2.3.3(c).

~~i)e)~~ The unit must be equipped with the manual coupling system in accordance with the prescriptions set out in Appendix C section 1 including the fulfilment of section 8 or with any semi-automatic or automatic standardised coupling system.

~~j)f)~~ The brake system must be in accordance with the conditions of Appendix C sections 9, 14 and 15 when applying the reference case set out in point 4.2.4.2.

~~k)g)~~ The unit must be marked with all applicable markings in accordance with EN 15877-1:2012, except the marking defined in its clause 4.5.25(b). ~~in particular with the marking on:~~

~~(i) the allocated interoperable gauge,~~

~~(ii) the vehicle tare weight,~~

~~(iii) the vehicle load table,~~

~~(iv) the length over buffers,~~

~~(v) the maintenance dates,~~

~~(vi) the lifting and re-railing signs,~~

~~(vii) the distance between the two end axles of the unit,~~

~~(viii) the distance between bogie centres,~~

~~(ix) the brake weight and~~

~~(x) the track gauge(s) the unit is compatible with and was assessed for.~~

 <b>OTIF</b>	<b>ROLLING STOCK</b> <b>FREIGHT WAGONS</b>		<b>UTP WAG</b> Page 59 of 151	
	Status: <b>PROPOSAL</b>		TECH-20005 Annex	Original: EN

h) The parking brake force shall be marked as set out in Figure 3, 30 mm below the marking defined in clause 4.5.3 of EN 15877-1:

*Figure 3*

**Marking of the parking brake force**

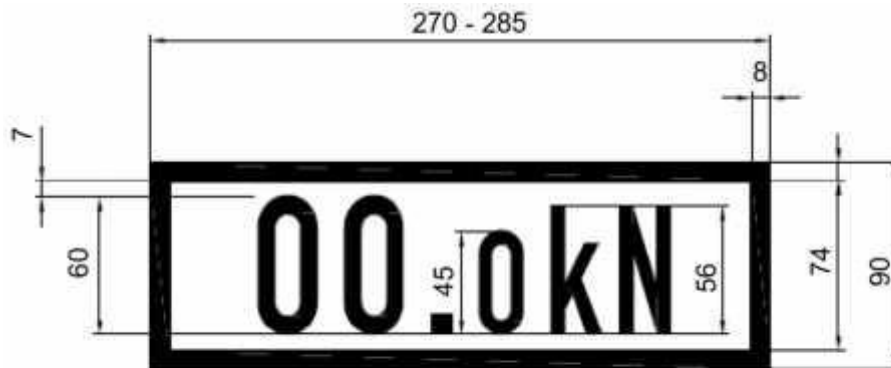

On the basis of Article 3a §1 of ATMF, vehicles which have been authorised according to EU law which is equivalent with to this UTP and which are compliant with all requirements set out in section 4.2 and in this point 7.1.2 shall be deemed as admitted to operation by all Contracting States.

When an international agreement to which the European Union is party provides for reciprocal legal provisions units which have been authorised to operate according to said international agreement and comply with all requirements set out in section 4.2 and in this point 7.1.2 shall be deemed as authorised for placing on the market in the States of the European Union.

**7.2. General rules for implementation ~~Substitution, renewal and upgrading~~**

**7.2.1. Substitution of interoperability constituents**

This section deals with substitutions of constituents

~~elements of construction~~ (ICs) as defined in Article 2(g) of ATMF, (Appendix G to the Convention)

~~constituents~~ as referred to in Article 2(p) of Directive (EU) 2016/797 ~~2008/57/EC and~~

~~the renewal or upgrading of freight wagons, including the substitution of elements within a unit, in accordance with the conditions laid down in~~

~~Article 10 § 11 of ATMF (Appendix G to the Convention)~~

~~Article 20 of Directive 2008/57/EC.~~

~~Concerning the substitution of constituents t~~ The following categories have to be considered: -

 <b>OTIF</b>	<b>ROLLING STOCK</b> <b>FREIGHT WAGONS</b>		<b>UTP WAG</b> Page 60 of 151	
	Status: <b>PROPOSAL</b>		TECH-20005 Annex	Original: EN

Certified ICs: Components which correspond to an IC in Chapter 5 and which are holding a certificate of conformity.

Other components: Any component, which is not corresponding to an IC in Chapter 5.

Non-certified ICs: Components which correspond to an IC in Chapter 5 but are not holding a certificate of conformity and which are produced before the expiry of the transitional period referred to in section 6.3.

Table 11 shows the possible permutations.

*Table 11*  
**Substitution permutation table**

	<u>... substituted by ...</u>		
	<u>... certified ICs</u>	<u>... other components</u>	<u>... non-certified ICs</u>
Certified ICs_...	check	not possible	Check
Other components_...	not possible	check	not possible
Non-certified ICs_...	check	not possible	Check

The word “check” in table 11 means that the entity in charge of maintenance (ECM) may under its responsibility substitute a component by another one utilising the same function and at least the same performance in accordance with the relevant

UTP.

TSI.

requirements considering that these components are

- suitable, i.e. conform to the relevant

UTP(s).

TSI(s).

- used within its area of use,
- enabling interoperability,
- meeting the essential requirements, and
- in line with restrictions ~~eventually~~ stated in the technical file.

~~When the extent of the work leads to a different function or performance or in case of a substitution of an element within the unit, the contracting entity or the manufacturer is required to send the~~

~~Contracting State(s) where the vehicle was first permitted to operate a file describing the project as set out in Article 10 § 11 of ATMF (Appendix G to the Convention).~~

~~Member State concerned a file describing the project as set out in Article 20 of Directive 2008/57/EC. The Member State decides whether a new authorisation for placing in service is needed.~~

~~The Contracting State(s) shall decide whether a new admission to operation is needed.~~

 <b>OTIF</b>	<b>ROLLING STOCK</b> <b>FREIGHT WAGONS</b>		<b>UTP WAG</b> Page 61 of 151	
	Status: <b>PROPOSAL</b>		TECH-20005 Annex	Original: EN

## 7.2.2. Changes to an existing unit or to an existing unit type

### 7.2.2.1. Introduction

Point 7.2.2 defines the principles to be applied by

the entity managing the changes.

The entity managing the change is either the holder of the Certificate of Operation of a vehicle, which, in accordance with Article 11 § 8 of ATMF, is the keeper, or, if the change concerns a type, the holder of the Design Type Certificate.

the entities managing the change and authorising entities in line with the EC verification procedure described in Article 15(9), Article 21(12) and Annex IV of Directive (EU) 2016/797. This procedure is further developed in Article 13, 15 and 16 of Commission Implementing Regulation (EU) 2018/545<sup>50</sup> and in Decision 2010/713/EC<sup>51</sup>.

This point applies in case of any change(s) to an existing unit or unit type, including renewal or upgrade. It does not apply in case of changes:

- that do not introduce a deviation from the technical files accompanying the UTP declarations for verification for the subsystems, if any, and
- that do not have an impact on basic parameters not covered by the UTP declaration, if any.

The holder of the

Design Type Certificate, if this is not itself the entity managing the change,

vehicle type authorisation

shall provide, under reasonable conditions, the information necessary for assessing the changes to the entity managing the change.

### 7.2.2.2. Rules to manage changes in both a unit or a unit type

Parts and basic parameters of the unit that are not affected by the change(s) are exempt from conformity assessment against the provisions in this UTP.

Without prejudice to clause 7.2.2.3, compliance with the requirements of this UTP or the

UTP Noise or the equivalent TSI

TSI Noise (Commission Regulation No 1304/2014<sup>52</sup>, see clause 7.2 of that TSI)

<sup>50</sup> Commission Implementing Regulation (EU) 2018/545 of 4 April 2018 establishing practical arrangements for the railway vehicle authorisation and railway vehicle type authorisation process pursuant to Directive (EU) 2016/797 of the European Parliament and of the Council (OJ L 90, 6.4.2018, p. 66).

<sup>51</sup> Commission Decision 2010/713/EU of 9 November 2010 on modules for the procedures for assessment of conformity, suitability for use and EC verification to be used in the technical specifications for interoperability adopted under Directive 2008/57/EC of the European Parliament and of the Council (OJ L 319, 4.12.2010, p. 1).

<sup>52</sup> Commission Regulation (EU) No 1304/2014 of 26 November 2014 on the technical specification for interoperability relating to the subsystem 'rolling stock — noise' amending Decision 2008/232/EC and repealing Decision 2011/229/EU (OJ L 356, 12.12.2014, p. 421).



 <b>OTIF</b>	<b>ROLLING STOCK FREIGHT WAGONS</b>		<b>UTP WAG</b> Page 62 of 151
Status: <b>PROPOSAL</b>		TECH-20005 Annex	Original: EN Date: 17.06.2020

shall only be needed for the basic parameters in this UTP which may be affected by the change(s).

Any basic parameter of a vehicle or a vehicle type affected by the changes shall be analysed and categorised in one of the following categories:

1. Changes that do not introduce a deviation from the technical file.
2. Changes that do not fall into category 1 and which do not change the basic design characteristics as per table 11a.
3. Changes that do not fall into category 2 and which do not require a new admission in accordance with the criteria in this section.
4. Changes that do not fall into categories 1-3 and specific changes described in this section.

For category 1 no further action is required.

For categories 2 and 3 the technical file shall be updated and the holder of the Design Type Certificate or, if there is no Design Type Certificate, the holder of the Certificate of Operation shall make the relevant information available to the competent authorities upon request.

For category 4, a new admission in accordance with Article 10 § 11 of ATMF is required. An assessing entity shall be informed by the entity managing the change of all changes to the subsystem that affect the conformity with requirements of the relevant UTPs(s) and which require new checks by the assessing entity.

Modules SB, SD/SF or SH1 as defined in UTP GEN—D shall apply mutatis mutandis to the assessment of changes.

The assessing entity shall be provided with all relevant technical documentation relating to the existing Design Type Certificate and, if available, the Certificate of Operation.

For physical vehicles this information shall be provided by the keeper, as holder of the Certificate of Operation.

In accordance with Articles 15 and 16 of Commission Implementing Regulation (EU) 2018/545 and Decision 2010/713/EU and by application of modules SB, SD/SF or SH1 for the EC verification, and if relevant in accordance with Article 15(5) of Directive (EU) 2016/797, the entity managing the change shall inform a notified body of all changes affecting the conformity of the subsystem with requirements of the relevant TSI(s) requiring new checks by a notified body. This information shall be provided by the entity managing the change with corresponding references to the technical documentation relating to the existing EC type or design examination certificate.

 <b>OTIF</b>	<b>ROLLING STOCK FREIGHT WAGONS</b>		<b>UTP WAG</b> Page 63 of 151
Status: <b>PROPOSAL</b>		TECH-20005 Annex	Original: EN Date: 17.06.2020

If the change is to a type of vehicle, the holder of the Design Type Certificate shall provide this information.

In case of changes requiring reassessment of the safety requirements set out in clauses 4.2.4.2 for the brake system, a new vehicle admission shall be required, unless one of the following conditions is met:

- After the change, the brake system fulfils the conditions of C.9 and C.14 of Appendix C, or
- Both the original and changed brake systems fulfil the safety requirements set out in clause 4.2.4.2

Changes of category 3 and 4 require assessment as to whether the overall safety level of the vehicle is adversely affected by the changes.

The following changes shall fall into category 3:

- Changes above the thresholds set out in column 3 and below thresholds set out in column 4 of Table 11a and which do not adversely affect the overall safety level of the vehicle.

The following changes shall fall into category 4:

- Changes above the thresholds set out in column 4 of Table 11a and changes which may adversely affect the overall safety level of the vehicle.

Without prejudice of the general safety judgement mandated in article 21(12)(b) of Directive (EU) 2016/797, in case of changes requiring reassessment of the safety requirements set out in clauses 4.2.4.2 for the brake system, a new authorization for placing on the market will be required unless one of the following conditions are met:

- The brake system fulfils the conditions of C.9 and C.14 of Appendix C after change or,
- Both the original and changed brake systems fulfil the safety requirements set out in clause 4.2.4.2

National migration strategies related to the implementation of other TSIs (e.g. TSIs covering fixed installations) shall be taken into account when defining to what extent the TSIs covering rolling stock needs to be applied.

The basic design characteristics of the rolling stock are defined in Table 11a.

Based on these tables and on the safety judgement mandated in Article 21(12)(b) of Directive (EU) 2016/797, the changes shall be categorised as follows:

- 15(1)(c) of Commission Implementing Regulation (EU) 2018/545 if they are above the thresholds set out in column 3 and below thresholds set out in column 4 unless the safety judgement mandated in Article 21(12)(b) of Directive (EU) 2016/797 requires to categorise them as 15(1)(d), or
- 15(1)(d) of Commission Implementing Regulation (EU) 2018/545 if they are above the thresholds set out in column 4 or if the safety judgement mandated in Article 21(12)(b) of Directive (EU) 2016/797 requires to categorise them as 15(1)(d).

 <b>OTIF</b>	<b>ROLLING STOCK FREIGHT WAGONS</b>		<b>UTP WAG</b> Page 64 of 151	
Status: <b>PROPOSAL</b>		TECH-20005 Annex	Original: EN	Date: 17.06.2020

Whether the changes are beyond or above the thresholds mentioned above shall be determined in reference to the values of the parameters at the time

of the most recent admission of the rolling stock or rolling stock type.

of the last authorisation of the rolling stock or rolling stock type.

Changes not referred to in the paragraph above are deemed not to have any impact on the basic design characteristics and

will fall into category 1 or 2, unless the assessment of the overall safety level of the vehicle concludes that safety is adversely affected by the changes. In such case the changes fall into category 4.

will be categorised as 15(1)(a) or 15(1)(b) of Commission Implementing Regulation (EU) 2018/545, unless the safety judgement mandated in Article 21(12)(b) of Directive (EU) 2016/797 requires to categorise them as 15(1)(d).

The assessment as to whether the overall safety level of the vehicle is adversely affected shall be carried out in accordance with UTP GEN-G and shall cover all changes concerning basic parameters of table 1, related to all the essential requirements, in particular the requirements “Safety” and “Technical compatibility”.

The safety judgement mandated in Article 21(12)(b) of Directive (EU) 2016/797 shall cover all changes concerning basic parameters of table 1, related to all the essential requirements, in particular the requirements “Safety” and “Technical compatibility”.

Without prejudice to clause 7.2.2.3, all changes shall remain compliant with the applicable UTPs, regardless of their classification.

Without prejudice to clause 7.2.2.3, all changes shall remain compliant with the applicable TSIs regardless their classification.

The replacement of a whole element within a rake of permanently connected elements after severe damage does not require a conformity assessment against this UTP, as long as the element is identical to the one it replaces. Such element must be traceable and certified in accordance with any national or international rule, or any code of practice widely acknowledged in the railway domain.

*Table 11a*

**Basic design characteristics related to basic parameters set out in the UTP WAG**

 <b>OTIF</b>	<b>ROLLING STOCK</b> <b>FREIGHT WAGONS</b>		<b>UTP WAG</b> Page 65 of 151
	Status: <b>PROPOSAL</b>	TECH-20005 Annex	Original: EN

<a href="#">1. clause</a>	<a href="#">2. Related basic design characteristic(s)</a>	<a href="#">3. Changes<sup>53</sup> impacting the basic design characteristic which remain within the range of acceptable parameters with respect to technical compatibility with the area of use</a>	<a href="#">4. Changes<sup>54</sup> impacting the basic design characteristic which go beyond the range of acceptable parameters with respect to technical compatibility with the area of use</a>
<a href="#">4.2.2.1.1 End coupling</a>	<a href="#">Type of end coupling</a>	<a href="#">Change of end coupler type</a>	N/A
<a href="#">4.2.3.1 Gauging</a>	<a href="#">Reference profile</a>	N/A	<a href="#">Change of reference profile the vehicle is conform to</a>
	<a href="#">Minimum vertical convex curve radius capability</a>	<a href="#">Change in minimum vertical convex curve radius capability the unit is compatible with of more than 10%</a>	N/A
	<a href="#">Minimum vertical concave curve radius capability</a>	<a href="#">Change in minimum vertical concave curve radius capability the unit is compatible with of more than 10%</a>	N/A
<a href="#">4.2.3.2. Compatibility with load carrying capacity of lines</a>	<a href="#">Permissible payload for different line categories</a>	<a href="#">Change(*) of any of the vertical loading characteristics resulting in a change of the line category(ies) the wagon is compatible with</a>	N/A
<a href="#">4.2.3.3 Compatibility with train detection systems</a>	<a href="#">Compatibility with train detection systems</a>	N/A	<a href="#">Change of declared compatibility with one or more of the three train detection systems:</a> <a href="#">Track circuits</a> <a href="#">Axle counters</a> <a href="#">Loop equipment</a>
<a href="#">4.2.3.4 Axle bearing condition monitoring</a>	<a href="#">On-board detection system</a>	N/A	<a href="#">Fitting/Removal of on-board detection system</a>

<sup>53</sup> EU title: “Changes impacting the basic design characteristic and not classified as 21(12)(a) of Directive (EU) 2016/797”

<sup>54</sup> EU title: “Changes -impacting the basic design characteristic and classified as 21(12)(a) of Directive (EU) 2016/797”

 <b>OTIF</b>	<b>ROLLING STOCK</b> <b>FREIGHT WAGONS</b>		<b>UTP WAG</b> Page 66 of 151
	Status: <b>PROPOSAL</b>	TECH-20005 Annex	Original: EN

<a href="#">1. clause</a>	<a href="#">2. Related basic design characteristic(s)</a>	<a href="#">3. Changes<sup>53</sup> impacting the basic design characteristic which remain within the range of acceptable parameters with respect to technical compatibility with the area of use</a>	<a href="#">4. Changes<sup>54</sup> impacting the basic design characteristic which go beyond the range of acceptable parameters with respect to technical compatibility with the area of use</a>
<a href="#">4.2.3.5 Running safety</a>	<a href="#">Combination of maximum speed and maximum cant deficiency for which the unit was assessed</a>	<a href="#">N/A</a>	<a href="#">Increase in maximum speed of more than 15 km/h or change of more than <math>\pm 10\%</math> in maximum admissible cant deficiency</a>
	<a href="#">Rail inclination</a>	<a href="#">N/A</a>	<a href="#">Change of rail inclination the vehicle is conform to(**)</a>
<a href="#">4.2.3.6.2 Characteristics of wheelsets</a>	<a href="#">Wheelset gauge</a>	<a href="#">N/A</a>	<a href="#">Change of track gauge the wheelset is compatible with</a>
<a href="#">4.2.3.6.3 Characteristics of wheels</a>	<a href="#">Minimum required in-service wheel diameter</a>	<a href="#">Change of minimum required in-service diameter of more than 10 mm</a>	<a href="#">N/A</a>
<a href="#">4.2.3.6.6 Automatic variable gauge systems</a>	<a href="#">Wheelset gauge changeover facility</a>	<a href="#">Change in the unit leading to a change in the changeover facility(ies) the wheelset is compatible with</a>	<a href="#">Change of track gauge(s) the wheelset is compatible with</a>
<a href="#">4.2.4.3.2.1 Service brake</a>	<a href="#">Stopping distance</a>	<a href="#">Change of stopping distance of more than <math>\pm 10\%</math></a>  <a href="#">Note: Brake weight percentage (also called 'lambda' or 'braked mass percentage') or braked mass may also be used, and can be derived (directly or via stopping distance) from deceleration profiles by a calculation.</a>  <a href="#">The allowed change is the same (<math>\pm 10\%</math>)</a>	<a href="#">N/A</a>
	<a href="#">Maximum deceleration for the load condition 'design mass' under normal payload at the maximum design speed</a>	<a href="#">Change of more than <math>\pm 10\%</math> on the maximum average brake deceleration</a>	<a href="#">N/A</a>
<a href="#">4.2.4.3.2.2 Parking brake</a>	<a href="#">Parking brake</a>	<a href="#">Parking brake function installed/removed</a>	<a href="#">N/A</a>

 <b>OTIF</b>	<b>ROLLING STOCK</b> <b>FREIGHT WAGONS</b>		<b>UTP WAG</b> Page 67 of 151
	Status: <b>PROPOSAL</b>	TECH-20005 Annex	Original: EN

<a href="#">1. clause</a>	<a href="#">2. Related basic design characteristic(s)</a>	<a href="#">3. Changes<sup>53</sup> impacting the basic design characteristic which remain within the range of acceptable parameters with respect to technical compatibility with the area of use</a>	<a href="#">4. Changes<sup>54</sup> impacting the basic design characteristic which go beyond the range of acceptable parameters with respect to technical compatibility with the area of use</a>
<a href="#">4.2.4.3.3 Thermal capacity</a>	<a href="#">Thermal capacity expressed in terms of Speed Gradient Brake distance</a>	<a href="#">N/A</a>	<a href="#">New reference case declared</a>
<a href="#">4.2.4.3.4 Wheel slide protection (WSP)</a>	<a href="#">Wheel slide protection</a>	<a href="#">N/A</a>	<a href="#">Fitting/removal of WSP function</a>
<a href="#">4.2.5 Environmental conditions</a>	<a href="#">Temperature range</a>	<a href="#">Change of temperature range (T1, T2, T3)</a>	<a href="#">N/A</a>
	<a href="#">Snow, ice and hail conditions</a>	<a href="#">Change of the selected range 'snow, ice and hail' (nominal or severe)</a>	<a href="#">N/A</a>

*(\*) [Change of the loading characteristics is not to be re-assessed in operation \(loading/unloading of the wagon\)](#)*

*(\*\*) [The rolling stock fulfilling one of the following conditions are deemed to be compatible with all rail inclinations:](#)*

- [Rolling stock assessed according to EN 14363:2016](#)*
- [Rolling stock assessed according to EN 14363:2005 \(amended or not amended by ERA/TD/2012-17/INT\) or UIC 518:2009 with the result, that there is no restriction to one rail inclination](#)*
- [vehicles assessed according to EN 14363:2005 \(amended or not amended by ERA/TD/2012-17/INT\) or UIC 518:2009 with the result, that there is a restriction to one rail inclination and a new assessment of the wheel-rail-contact test conditions based on real wheel- and rail profiles and measured track gauge show compliance with the requirements on wheel-rail-contact conditions of EN 14363:2016](#)*

[In order to establish the type or design examination certificate<sup>55</sup>](#)

[in accordance with UTP GEN-D, the assessing entity is permitted to refer to:](#)

[, the notified body selected by the entity managing the change is permitted to refer to:](#)

<sup>55</sup> In EU law reference is made to the EC type or design examination certificate.

 <b>OTIF</b>	<b>ROLLING STOCK FREIGHT WAGONS</b>		<b>UTP WAG</b> Page 68 of 151	
Status: <b>PROPOSAL</b>		TECH-20005 Annex	Original: EN	Date: 17.06.2020

The original type or design examination certificate for parts of the design that are unchanged or those that are changed but do not affect the conformity of the subsystem, as far as it is still valid (during 10 year phase B period).

Additional type or design examination certificate (amending the original certificate) for modified parts of the design that affect the conformity of the subsystem with the latest revision of this UTP or equivalent TSI in force at that time.

In any case, the entity managing the change shall ensure that the technical documentation which is relating to the type or design examination certificate is updated accordingly.

The updated technical documentation, related to the type or design examination certificate is referred to in the technical file accompanying the declaration of verification issued by the entity managing the change for rolling stock declared as conformant to the modified type.

### 7.2.2.3. Particular rules for existing units

of which the admission to international traffic was prior to 1 January 2015 and was not based on UTPs or equivalent EU provisions.

The following rules apply, in addition to clause 7.2.2.2, to existing units with a first admission to international traffic before 1 January 2015, which were not assessed for compliance with the UTPs before their admission.

Changes shall be deemed compliant with the technical requirements in this UTP if:

- the values of the parameters set out in the UTP are improved in the direction of the value defined in the UTP and
- the entity managing the change demonstrates that the essential requirements which are concerned by the change are met and
- the safety level is not reduced.

The entity managing the change shall, in cases where the UTP requirement was not met, justify the reason why the UTP requirement was not met.

This justification shall be in the technical file, if any, or in the original technical documentation of the unit.

not covered by an EC declaration of verification with a first authorisation for placing in service before 1 January 2015

The following rules apply, in addition to clause 7.2.2.2, to existing units with a first authorisation for placing in service before 1 January 2015, where the scope of the change has an impact on basic parameters not covered by the EC declaration

The compliance with technical requirements of this TSI is deemed established when a basic parameter is improved in the direction of the TSI defined performance and the entity managing the change demonstrates that the corresponding essential requirements are met and the safety level is maintained and, where reasonably practicable, improved.

The entity managing the change shall in this case justify the reasons for which the TSI defined performance was not met, taking into account migration strategies of other TSIs as stated in section 7.2.2.2.

 <b>OTIF</b>	<b>ROLLING STOCK</b> <b>FREIGHT WAGONS</b>		<b>UTP WAG</b> Page 69 of 151	
	Status: <b>PROPOSAL</b>		TECH-20005 Annex	Original: EN

The particular rule set out in the above paragraph is not applicable in changes impacting the basic parameters and classified as 21(12)a set out in table 11b. For those changes, compliance with the UTP requirements is mandatory.

*Table 11b*

**Changes to basic parameters of vehicles of which the admission to international traffic was not based on UTPs or equivalent EU provisions.<sup>56</sup>**

<u>UTP clause</u>	<u>Related basic design characteristic(s)</u>	<u>Changes which shall comply with the UTP requirements<sup>57</sup></u>
<u>4.2.3.1 Gauging</u>	<u>Reference profile</u>	<u>Change of reference profile the unit is conform to</u>
<u>4.2.3.3 Compatibility with train detection systems</u>	<u>Compatibility with train detection systems</u>	<u>Change of declared compatibility with one or more of the three train detection systems:</u> <u>Track circuits</u> <u>Axle counters</u> <u>Loop equipment</u>
<u>4.2.3.4 Axle bearing condition monitoring</u>	<u>On-board detection system</u>	<u>Fitting/Removal of on-board detection system</u>
<u>4.2.3.6.2 Characteristics of wheelsets</u>	<u>Wheelset gauge</u>	<u>Change of track gauge the wheelset is compatible with</u>
<u>4.2.3.6.6 Automatic variable gauge systems</u>	<u>Wheelset gauge changeover facility</u>	<u>Change of track gauge(s) the wheelset is compatible with</u>

7.2.3. Rules related to the type or design examination certificates

7.2.3.1. Rolling stock subsystem

This point concerns the procedure referred to in Article 10 of ATMF according to which a Design Type Certificate related to a

This point concerns a rolling stock type (unit type in the context of this TSI), as defined in Article 2(26) of Directive (EU) 2016/797,

<sup>56</sup> Title of this table in the TSI: “Changes to basic parameters for which compliance with TSI requirements is mandatory for rolling stock not holding an EC type or design examination certificate”

<sup>57</sup> Title of this column in the TSI: “Changes impacting the basic design characteristic and classified as 21(12)(a) of Directive (EU) 2016/797”



 <b>OTIF</b>	<b>ROLLING STOCK FREIGHT WAGONS</b>		<b>UTP WAG</b> Page 70 of 151	
Status: <b>PROPOSAL</b>		TECH-20005 Annex	Original: EN	Date: 17.06.2020

vehicle type and a Certificate of Operation related to a vehicle are granted.

The basis of assessment is defined in in columns ‘Design review’ and ‘Type test’ of Appendix F of this UTP and of Appendix C of the UTP Noise.

which is subject to an EC type or design verification procedure in accordance with section 6.2 of this TSI. It also applies to the EC type or design verification procedure in accordance with the TSI Noise, which refers to this TSI for its scope of application to freight units.

The TSI assessment basis for an EC type or design examination is defined in columns ‘Design review’ and ‘Type test’ of Appendix F of this TSI and of Appendix C of the TSI Noise.

#### 7.2.3.1.1 Phase A

Phase A starts at the moment an assessing entity is appointed and ends when the Design Type Certificate is issued, or after four years, whichever comes first.

During Phase A, the applicable technical requirements shall not change.

When a revision of this UTP or of the UTP Noise comes into force during the phase A period, it is permissible (but not mandatory) to use the revised version(s), either totally or for particular sections, unless explicitly otherwise specified in the revision of these UTPs. In case of application limited to particular sections, the applicant has to justify and document that applicable requirements remain consistent, and this has to be approved by the Competent Authority.

Phase A starts once a notified body, which is responsible for EC verification, is appointed by the applicant and ends when the EC type or design examination certificate is issued.

The TSI assessment basis for a type is defined for a phase A period, with a duration of maximum four years. During the phase A period the assessment basis for EC verification to be used by the notified body will not change.

When a revision of this TSI or of the TSI Noise comes into force during the phase A period, it is permissible (but not mandatory) to use the revised version(s), either totally or for particular sections, unless explicitly otherwise specified in the revision of these TSIs. In case of application limited to particular sections, the applicant has to justify and document that applicable requirements remain consistent, and this has to be approved by the notified body.

#### 7.2.3.1.2 Phase B

Phase B starts at the moment the Design Type Certificate is issued and ends 10 years later.

During the Phase B period, Certificates of Operation may be issued for vehicles complying with the Design Type Certificate.

Modifications to this UTP or the UTP Noise shall not apply during the Phase B period, unless specified otherwise in these revised

The phase B period defines the period of validity of the EC type or design examination certificate once it is issued by the notified body. During this time, units may be EC certified on the basis of conformity to type.

The EC type or design examination certificate of EC verification for the subsystem is valid for a ten-year phase B period after its issue date, even if a revision of this TSI or of the TSI Noise come into

 <b>OTIF</b>	<b>ROLLING STOCK FREIGHT WAGONS</b>		<b>UTP WAG</b> Page 71 of 151	
Status: <b>PROPOSAL</b>		TECH-20005 Annex	Original: EN	Date: 17.06.2020

### UTPs.

force, unless explicitly otherwise specified in the revision of these TSIs. During this period of validity, new rolling stock of the same type is permitted to be placed on the market on the basis of an EC declaration of verification referring to the type certificate of verification.

The updated technical documentation related to the EC type or design examination certificate is referred to in the technical file accompanying the EC declaration of verification issued by the applicant for rolling stock declared as conformant to the modified type.

### 7.2.3.2. Interoperability constituents

In accordance with UTP GEN-D, Contracting States may require the mandatory separate assessment of ICs. If not required by the Contracting State, separate assessment of ICs may be carried out on a voluntary basis.

In case of conformity assessment of an IC as part of the subsystem, the compliance of the IC with the applicable provisions is verified by applying the modules for subsystem in accordance with section 6.2 of this UTP.

This point concerns interoperability constituents which are subject to EC type examination (module CB), design examination (module CH1) or to suitability for use (module CV) in accordance with section 6.1 of this TSI.

The EC type or design examination or suitability for use certificate is valid for a ten-year period. During this time, new constituents of the same type are permitted to be placed on the market without a new type assessment, unless explicitly otherwise specified in the revision of this TSI. Before the end of the ten-year period, the constituent shall be assessed according to the latest revision of this TSI in force at that time, for those requirements that have changed or are new in comparison to the certification basis.

## 7.3. **Specific cases**

### 7.3.1. *Introduction*

The specific cases, as listed in point 7.3.2, are classified as:

- “P” cases: “permanent” cases.
- “T” cases: “temporary” cases, where ~~it is recommended~~ that the target system ~~is~~ shall be reached by 31 December 2020<sup>5</sup>

~~(an objective set in Decision 2010/661/EU of the European Parliament and of the Council of 7 July 2010 on Union guidelines for the development of the trans-European transport~~

 <b>OTIF</b>	<b>ROLLING STOCK FREIGHT WAGONS</b>		<b>UTP WAG</b> Page 72 of 151	
Status: <b>PROPOSAL</b>		TECH-20005 Annex	Original: EN	Date: 17.06.2020

~~network<sup>58</sup>~~).

All specific cases and their relevant dates shall be re-examined in the course of future revisions of the TSI with a view to limiting their technical and geographical scope based on an assessment of their impact on safety, interoperability, cross border services, TEN-T corridors, and the practical and economic impacts of retaining or eliminating them. Special account shall be given to availability of EU funding.

Specific cases shall be limited to the route or network where they are strictly necessary and taken account of through route compatibility procedures.

In case of a specific case applicable to a component defined as interoperability constituent in section 5.3 of this TSI, the conformity assessment has to be performed according to point 6.1.2.

### 7.3.2. *List of specific cases*

Specific cases for Contracting States which are also EU Member States are those which are included in the WAG TSI:~~2013~~.

(see section 7.3.2~~4~~ of WAG TSI:~~2013~~)

### 7.4. **Specific environmental conditions**

Specific environmental conditions for Contracting States which are also EU Member States are those which are included in the WAG TSI:~~2013~~.

(see section 7.4 of WAG TSI:~~2013~~)

### 7.5. **Freight wagons operating under national, bilateral, multilateral or international agreements**

Not applicable within the scope of this UTP.

(see section 7.5 of WAG TSI:~~2013~~)

### 7.6. Aspects that have to be considered in the revision process or in other activities of the Agency

[Reserved]

Further to the analysis performed during the drafting process of this TSI, particular aspects have been identified as of interest for

<sup>58</sup> OJ L 204, 5.8.2010, p. 1.

 <b>OTIF</b>	<b>ROLLING STOCK FREIGHT WAGONS</b>		<b>UTP WAG</b> Page 73 of 151	
Status: <b>PROPOSAL</b>		TECH-20005 Annex	Original: EN	Date: 17.06.2020

the future development of the EU railway system.

These aspects are identified below.

7.6.1. Rules for extension of area of use for existing rolling stock not covered by an EC declaration of verification

Pursuant to Article 54(2) and (3) of Directive (EU) 2016/797, vehicles authorised for placing in service prior to 15 June 2016 shall receive an authorization for placing on the market according to Article 21 of Directive (EU) 2016/797 in order to operate on one or more networks which are not yet covered by their authorisation. Such vehicles shall thus be conform to this TSI or benefit from a non-application of this TSI pursuant to Article 7(1) of Directive 2016/797.

In order to facilitate the free movement of vehicles, provisions shall be developed to set out which level of flexibility could be granted to such vehicles as well as to vehicles which were not subject to authorization, as regards compliance with the TSI requirements while fulfilling the essential requirements, maintaining the appropriate safety level, and where reasonably practicable, improving it.

 <b>OTIF</b>	<b>ROLLING STOCK</b> <b>FREIGHT WAGONS</b>		<b>UTP WAG</b> Page 74 of 151
	Status: <b>PROPOSAL</b>	TECH-20005 Annex	Original: EN

### **Appendix A: Open Points**

Not used.

Certain technical aspects, corresponding to the essential requirements, which are not explicitly covered by the specifications, are open points. These are stipulated in sections 4.2 and 6.2 and listed in table A.1.

*Table A.1*

#### ***List of open points***

<b>Element of the Rolling Stock sub-system</b>	<b>Point</b>	<b>Technical aspect not covered by this UTP / TSI</b>	<b>Link to other subsystems to cover the open point</b>
Axle bearing condition monitoring	4.2.3.4	Option on board equipment	Equipment not mandatory.
Test conditions for on-track tests as set out in the EN 14363 are not always fully achievable	6.2.2.3 (4.2.3.5.2)	track geometric quality and combinations of speed, curvature, cant deficiency (point 5.4.2 of EN 14363).	
Variable gauge wheelsets	4.2.3.6.6	Assessment concerning the following requirement: The changeover mechanism of the variable gauge wheelset shall ensure the safe locking in the correct intended axial position of the wheel and any brake equipment attached.	

 <b>OTIF</b>	<b>ROLLING STOCK</b> <b>FREIGHT WAGONS</b>		<b>UTP WAG</b> Page 75 of 151
	Status: <b>PROPOSAL</b>	TECH-20005 Annex	Original: EN

## **Appendix B: Specific procedures for running dynamics**

### Not used

*This appendix is a transcription of ERA technical document ERA/TD/2013/01/INT version 1.0 of 11.02.2013 published on the ERA website and referred to in the WAG TSI. It appears in full width in order that the drawings remain legible.*

### **1. — Specific assessment concerning running dynamic testing following EN 14363**

#### **1.1. — Conditions for testing on one rail inclination**

- The parameter equivalent conicity  $\tan \gamma_e$  for tangent track and large radius curves shall be distributed so that  $\tan \gamma_e = 0,2 \pm 0,05$  occurs in a range of the amplitude ( $y$ ) of the wheelsets lateral displacement between  $\pm 2$  and  $\pm 4$  mm for a minimum of 50% of track sections.
- The instability criterion in EN14363:2005 shall be assessed for low frequency body motions on at least two track sections with equivalent conicities less than 0.05 (mean value over the track sections).
- The instability criterion in EN14363:2005 shall be assessed on at least two track sections with equivalent conicities in accordance with table B.1.

*Table B.1*

*Conditions for contact conditions in relation to on-track testing*

<b>Maximum vehicle speed</b>	<b>Equivalent conicity</b>
60 km/h < V ≤ 140 km/h	≥0,50
140 km/h < V ≤ 200 km/h	≥0,40
200 km/h < V ≤ 230 km/h	≥0,35
230 km/h < V ≤ 250 km/h	≥0,30

#### **1.2. — Limit values for running safety**

The limit values for running safety specified in clause 5.3.2.2 of EN 14363:2005 and for axle loads above 22,5 t in clause 5.3.2.2 of EN 15687:2010 shall be met and verified.

When the quotient of guiding force and wheel force ( $Y/Q$ ) limit is exceeded, it is allowed to recalculate the  $Y/Q$  estimated maximum value in accordance with the following process:

- create an alternative test zone made up of all track sections with  $300 \text{ m} \leq R \leq 500 \text{ m}$ ,
- for the statistical processing per section, use  $x_i$  (97,5%) instead of  $x_i$  (99,85%),
- for statistical processing per zone, replace  $k=3$  (when using one dimensional method) or Student coefficient  $t$  ( $N-2$ ; 99%) (when using two dimensional method) by Student coefficient  $t$  ( $N-2$ ; 95%).

Both results (before and after recalculation) shall be reported.

#### **1.3. — Track loading limit values**

The limit values for track loading specified in EN 14363:2005 clause 5.3.2.3 and for loads above 22,5 t in EN 15687:2010 clause 5.3.2.2 shall be met and verified when so required by the methodology of EN 14363:2005.

 <b>OTIF</b>	<b>ROLLING STOCK</b> <b>FREIGHT WAGONS</b>		<b>UTP WAG</b> Page 76 of 151
	Status: <b>PROPOSAL</b>	TECH-20005 Annex	Original: EN

~~The quasi-static guiding force  $Y_{qst}$  limit value shall be evaluated for curve radii  $250 \leq R < 400$  m.~~

~~The limit value shall be:~~

~~——  $(Y_{qst})_{lim} = (30 + 10500/R_m)$  kN~~

~~——  $(Y_{qst})_{lim} = (33 + 11550/R_m)$  kN for the 1668 mm track gauge network,~~

~~where  $R_m$  = mean radius of the track sections retained for the evaluation.~~

~~When this limit value is exceeded due to high friction conditions, it is permitted to recalculate the estimated value of  $Y_{qst}$  on the zone after replacing the individual  $(Y_{qst})_i$  values on the track sections “i” where  $(Y/Q)_{if}$  (mean value of Y/Q ratio on the inner rail over the section) exceeds 0,40 by:  $(Y_{qst})_i - 50[(Y/Q)_{if} - 0,4]$ . Both results (before and after recalculation) shall be reported.~~

~~The values of the  $Y_{qst}$ ,  $Q_{qst}$  and mean curve radius (before and after recalculation) shall be recorded in the test report.~~

~~In case the  $Y_{qst}$  value exceeds the limit value expressed above, the operational performance of the unit (e.g. maximum speed) may be limited by the network, considering track characteristics (e.g. curve radius, cant, rail height).~~

## ~~2. Qualification of running gear~~

~~Following successful testing the acceptable parameter variation range is given by the range between the nominal tested parameters extended as illustrated in figure B.2.~~

~~It is permitted to perform only one test and by doing so only validating the running gear for a limited range.~~

*Fig. B.2*

*Parameter variation ranges for the acceptance after successful testing compared to the process in EN 14363:2005*

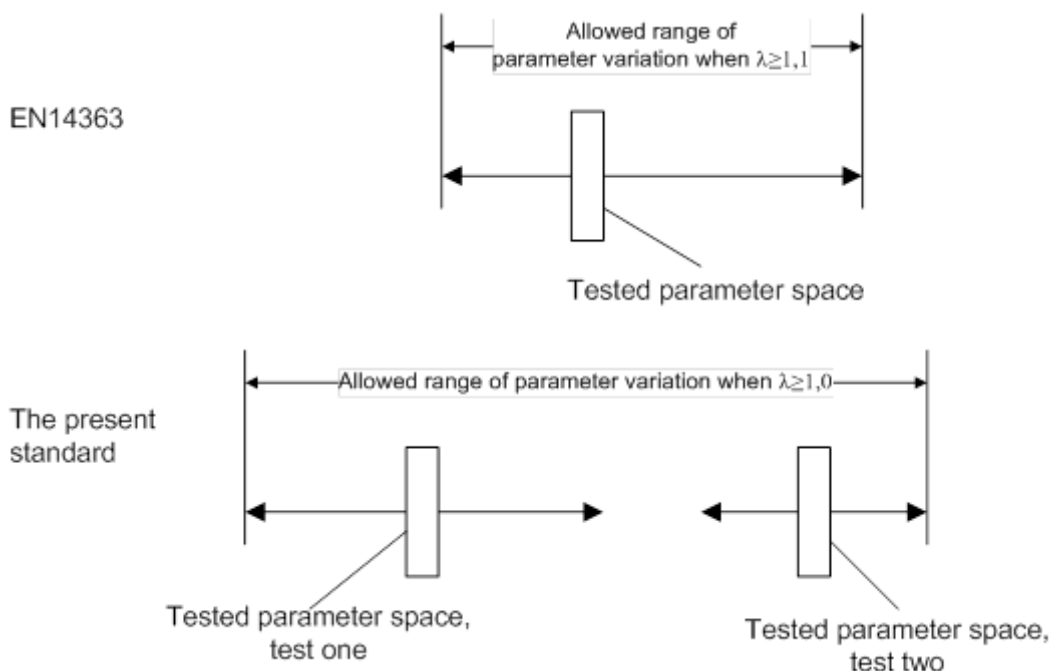

## 2.1. Test extent

The tests shall be carried out in accordance with the complete procedure in chapter 5 of EN14363:2005, considering the specific procedures as set out in Appendix B.1.

Units with an axle load higher than 22,5 t up to 25 t shall be tested in accordance with EN 15687:2010.

The tests shall be performed for the same intended operating conditions ( $v_{adm}$  and  $I_{adm}$ ):

- One test with a wagon of short running gear distance.
- One test with a wagon of long running gear distance

Other values of body parameters shall be within the ranges defined in table B.3.

Table B.3

Body parameters

		2-axle wagons		Bogie wagons	
		Short test wagon	Long test wagon	Short test wagon	Long test wagon
<b>Distance between running gear</b>	$2a^*$ [m] <sup>a)</sup>	$\leq 7$	$\geq 9$	$\leq 7$	$\geq 13$
<b>Acceptable range of torsional coefficient of vehicle body</b>	$e_i^*$ [kNmm <sup>2</sup> /rad]	0,5 x 10 <sup>10</sup> ... 8 x 10 <sup>10</sup>			



 <b>OTIF</b>	<b>ROLLING STOCK</b> <b>FREIGHT WAGONS</b>		<b>UTP WAG</b> Page 78 of 151	
	Status: <b>PROPOSAL</b>		TECH-20005 Annex	Original: EN

a)  $2a^*$  is the distance between wheelsets for 2-axle wagons or the distance between bogies for bogie wagons and  $ct^*$  is the vehicle body torsional stiffness coefficient.

**Note 1:**

For the purposes of assessment of running behaviour a typical loading condition must be tested. It is not necessary to test the worst position of the centre of gravity.

In addition, two axle wagons for speeds  $\geq 100$  km/h shall be tested in loaded condition also in sections of test zone 2 with clearances given by a gauge of  $\geq 1450$  mm in combination with wheelsets having distances between active faces at the minimum operation limit.

If the design parameters and the operation parameters require the application of the normal measuring method, it is nevertheless acceptable to perform such tests with one of the vehicles based on measurements of lateral acceleration. In that case, it shall be demonstrated that a relationship exists between accelerations and the sum of the guiding forces on the vehicle tested according to the normal measuring method and a related limit value shall be established.

**Note 2:**

This requirement is an extension of the application of the simplified measuring method, using information gathered with vehicle tested according to the normal measuring method.

**Note 3:**

This requirement is intended to be transferred to the test conditions in EN 14363:2005.

**2.2. Range of running gear parameters for dispensation from on-track tests**

Following successful testing in accordance with Appendix B section 2.1 the acceptable parameter variation range for dispensation from on-track tests is given by the range between the nominal tested parameters of the running gear and the extended range as illustrated in figure B.2 and specified in tables B.4 and B.5.

All parameters given in these tables are nominal values. The upper limit of the acceptable range depends on the maximum tested value of the respective parameter, the lower limit on the minimum tested value.

In case of extension of the already applicable parameter range of a running gear, new tests shall be performed with parameters outside the previously tested range.

*Table B.4*

*Accepted parameter ranges for a single axle running gear which was tested successfully in accordance with Appendix B section 2.1*

Nominal parameter		Minimum	Maximum
Maximum axle load	$P$	-	$P_{\text{tested}}$
Vertical eigenfrequency	$v_z$	$0.9 \cdot v_z$ in load range	$1.12 \cdot v_z$ in load range
Vertical damping		Nominal characteristics of tested running gear	

 <b>OTIF</b>	<b>ROLLING STOCK</b> <b>FREIGHT WAGONS</b>		<b>UTP WAG</b> Page 79 of 151	
	Status: <b>PROPOSAL</b>		TECH-20005 Annex	Original: EN

Lateral and longitudinal suspension characteristics		Nominal characteristics of tested running gear	
Distance between centres of axle bearings (suspension base)	$2b_z$	$2b_{z, \text{tested}} - 100 \text{ mm}$	$2b_{z, \text{tested}} + 170 \text{ mm}$
Wheel diameter	$D$	Diameter of tested application $D_{\text{tested}} - 90 \text{ mm}$	Diameter of tested application $D_{\text{tested}} + 90 \text{ mm}$

*Table B.5*

*Accepted parameter ranges for a bogie which was tested successfully in accordance with Appendix B section 2.1*

Nominal parameter		Minimum	Maximum
Maximum axle load	$P_{\text{max}}$	-	$1,05 \cdot P_{\text{max, tested}}$
Bogie axle distance (between outer axles of the bogie)	$2a^+$	$2a^+_{\text{tested}}$	$2a^+_{\text{tested}} + 0,2 \text{ m}$
Vertical eigenfrequency (see Appendix C)	$\nu_z$	$0,90 \cdot \nu_{z, \text{tested}}$ in full range between empty and loaded conditions	
Vertical Damping		Nominal characteristics of tested running gear	
Axle guiding longitudinal		Nominal characteristics of tested running gear	
Axle guiding lateral		Nominal characteristics of tested running gear	
Lateral secondary susp. characteristics		Nominal characteristics of tested running gear	
Distance between centres of axle bearings (suspension base)	$2b_z$	$2b_{z, \text{tested}} - 100 \text{ mm}$	$2b_{z, \text{tested}} + 170 \text{ mm}$
Yaw resistance of bogie <sup>a)</sup>	$M^z_z$	$0,80 \cdot M^z_{z, \text{tested}}$	$1,20 \cdot M^z_{z, \text{tested}}$
Moment of inertia of whole bogie (around z-axis)	$I^z_{zz}$	-	$1,10 \cdot I^z_{zz, \text{tested}}$
Wheel diameter	$D$	$D_{\text{tested}} - 90 \text{ mm}$	$D_{\text{tested}} + 90 \text{ mm}$
Nominal height of centre pivot	$h_{ep}$	$h_{ep, \text{tested}} - 150 \text{ mm}$	$h_{ep, \text{tested}} + 50 \text{ mm}$
<sup>a)</sup> for a friction based yaw resistance torque measured at two specified loads typical for empty and loaded condition. For other systems, appropriate parameters must be used to control stability and safety against derailment in empty condition and maximum guiding force in loaded conditions.			

 <b>OTIF</b>	<b>ROLLING STOCK</b> <b>FREIGHT WAGONS</b>		<b>UTP WAG</b> Page 80 of 151
	Status: <b>PROPOSAL</b>	TECH-20005 Annex	Original: EN

### 2.3 — Range of vehicle body parameters for dispensation from on-track tests

Following successful testing according to Appendix B section 2.1 the acceptable parameter variation range for a dispensation from on-track tests is given by the range between the nominal tested parameters of the vehicle body and the extended range where applicable as specified in table B.6. All parameters given in this table are nominal values. The upper limit of the acceptable range depends on the maximum tested value of the respective parameter; the lower limit on the minimum tested value.

To extend the applicable vehicle parameter range of a standardised running gear, test results of a third tested vehicle outside the previously tested range shall be used.

*Table B.6*

*Accepted parameter range for vehicles (including articulated wagons and permanently coupled units) equipped with a running gear which was tested successfully according to Appendix B section 2.1*

Nominal parameter		Minimum	Maximum
Distance between wheelsets (non-bogie vehicles)	$2a^{\oplus}$	Lowest value of either 6 m or $2a^{\oplus}_{\text{tested}}$	Highest value of either 10 m or $2a^{\oplus}_{\text{tested}}$
Distance between centres bogies (bogie vehicles)	$2a^{\oplus}$	Lowest value of either 6,5 m or $2a^{\oplus}_{\text{tested}}$	$2a^{\oplus}_{\text{tested}} + 3\text{m}$
Centre of gravity height of empty wagon	$h_{\text{eg}}$	-	$1,2 \cdot h_{\text{eg,empty,tested,max}}$
Coefficient of height of centre of gravity — loaded vehicle <sup>a)</sup>	$\chi$	-	$\chi_{\text{loaded,tested,max}} \times (1 + 0,8(\lambda' - 1))$ with $\lambda'$ factor for track loading parameters.
Torsional coefficient per vehicle body	$e_t^{\oplus}$	$> 0,5 \cdot 10^{10} \text{ kNmm}^2/\text{rad}$	-
Mean axle load of the tare unit (non-bogie wagon)	$P_{\text{mean,tare}}$	Smallest value of either 5,75 t or $P_{\text{mean,tare,tested}}$	-
Mean axle load of the tare unit (bogie wagon)	$P_{\text{mean,tare}}$	Smallest value of either 4 t or $P_{\text{mean,tare,tested}}$	-
Maximum axle load	$P$	-	$1,05 \cdot P_{\text{tested}}$
Mass distrib. coefficient (empty and loaded vehicle)	$\Phi$	-	$1,2 \cdot \Phi_{\text{tested}}$

<sup>a)</sup> for evaluation of  $\chi$  use admissible cant deficiency of 130 mm for axle loads  $\leq 225 \text{ kN}$  and 100 mm for axle loads  $> 225 \text{ kN}$  and up to 250 kN.

 <b>OTIF</b>	<b>ROLLING STOCK FREIGHT WAGONS</b>		<b>UTP WAG</b> Page 81 of 151	
Status: <b>PROPOSAL</b>		TECH-20005 Annex	Original: EN	Date: 17.06.2020

### **Appendix C: Additional optional conditions**

The compliance with the following set of conditions C.1 to C.18 is optional. If the applicant selects this option, [an Assessing Entity has to assess compliance within the UTP](#)

~~an Assessing Entity has to assess compliance within the~~

~~a notified body has to assess the compliance within the EC~~

verification procedure.

#### **1. Manual coupling system**

The manual coupling system shall comply with the following requirements:

- The screw coupling system excluding the draw hook shall comply with the requirements related to freight wagons of EN15566:2009+A1:2010 except clause 4.4,
- The draw hook shall comply with the requirements related to freight wagons of EN15566:2009+A1:2010 except clause 4.4 and except the dimension “a” in Annex A Figure A.1 which shall be treated as informative.
- The draw hook shall be located at a height between 920 and 1045 mm above rail level in all loading and wear conditions.
- The centreline of the draw hook shall be located within a range of 0 to 20mm below the buffing centre.
- The clearance for the draw hook shall be in accordance with [clause 6.3.2 of EN 16116-2:2013](#).

~~Appendix K~~

~~chapter 2 of ERA technical document ERA/TD/2012-04/INT version 1.2 of 18.01.2013 published on the ERA website (<http://www.era.europa.eu>).~~

- The buffer shall comply with the requirements related to freight wagons of EN15551:2009+A1:2010.
- The buffing centre line shall be located at a height between 940 and 1065 mm above rail level in all loading and wear conditions.
- There shall be no fixed parts within 40 mm of a vertical plane placed at the end of the fully compressed buffers.
- The space for shunting staff operation shall be in accordance with [clause 6.2.1 of EN 16116-2:2013](#). [For manual coupling systems equipped with 550 mm wide buffers the calculation of the free space may be done considering that the coupling gear components are lateral centrally positioned \(D = 0 mm as defined in Annex A of EN 16116-2:2013\).](#)

~~Appendix L~~

~~chapter 3 of ERA technical document ERA/TD/2012-04/INT version 1.2 of 18.01.2013 published on the ERA website (<http://www.era.europa.eu>).~~

 <b>OTIF</b>	<b>ROLLING STOCK</b> <b>FREIGHT WAGONS</b>		<b>UTP WAG</b> Page 82 of 151
	Status: <b>PROPOSAL</b>	TECH-20005 Annex	Original: EN

- Where a combined automatic and screw coupler is fitted, it is permissible for the auto coupler head to infringe the space specified above for shunting staff on the left hand side when it is stowed and the screw coupler is in use. In this case the marking in figure 75 of EN15877-1:2012 is mandatory.

Interaction of buffers and draw gear

- The characteristics of the buffers and draw gear shall be designed in order to enable the safe transit of curves in the track with a radius of 150 m. Two units with bogies coupled on straight track with touching buffers shall generate compressive forces not higher than 250 kN on a 150 m radius curve. There is no requirement specified for two axle units.
- The distance between the front edge of a draw-hook opening and the front side of the fully extended buffers shall be 355 mm +45/-20 mm in the new condition as shown in Figure C.1:

*Fig. C.1*

*Configuration of buffers and draw gear*

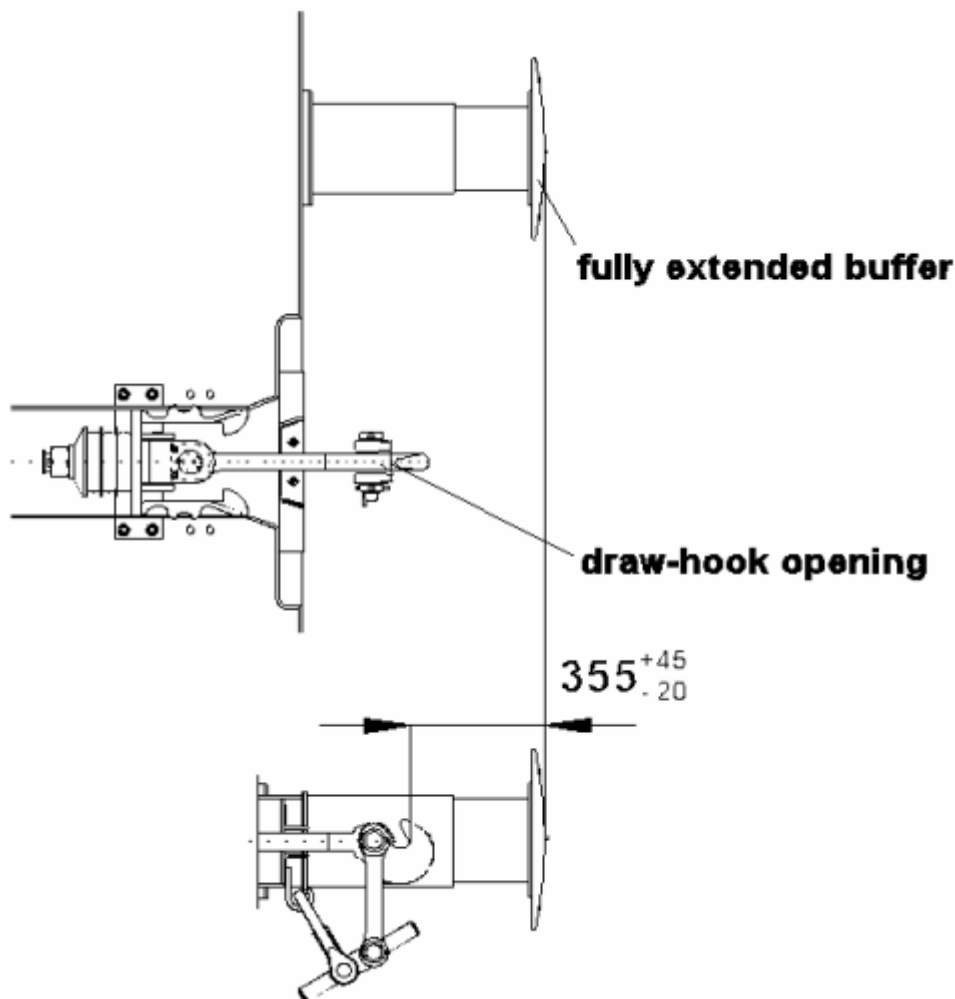

 <b>OTIF</b>	<b>ROLLING STOCK</b> <b>FREIGHT WAGONS</b>		<b>UTP WAG</b> Page 83 of 151	
	Status: <b>PROPOSAL</b>		TECH-20005 Annex	Original: EN

Units designed for 1435 mm and 1520 mm or 1435 mm and 1524 mm, or 1435 mm and 1668 mm gauge network(s), equipped with manual coupling and “UIC” pneumatic brake system, shall be compatible with both,

- the interface requirements for “End Coupling” mentioned before, and
- specific buffer layouts related to broad gauge networks.

In order to provide this full compatibility, it is permitted to have a different value of the distance between buffer centrelines, 1790 mm (Finland) and 1850 mm (Portugal and Spain) taking into account clause 6.2.3.1 of EN 15551:2009+A1:2010.

## 2. UIC footsteps and handrails

The unit shall be equipped with footsteps and handrails in accordance with [chapters 4 and 5 of EN 16116-2:2013](#) and with clearances in accordance with [clause 6.2.2 of EN 16116-2:2013](#).

*Appendix M*

*chapter 4 of ERA technical document ERA/TD/2012-04/INT version 1.2 of 18.01.2013 published on the ERA website (<http://www.era.europa.eu>).*

## 3. Ability to be hump shunted

In addition to the requirements of point 4.2.2.2 the unit shall be assessed in accordance with clause 8 of EN 12663-2:2010 and classified in Category F I in accordance with clause 5.1 of EN 12663-2:2010 with the following exception: for units designed to carry motor vehicles or combined transport units without long stroke shock absorbers the Category F-II may be used. The requirements concerning the buffing tests in clause 8.2.5.1 of EN 12663-2:2010 apply.

## 4. Free space under lifting points

The unit shall comply with figure C.2 on the free space under the re-railing places for rerailing:

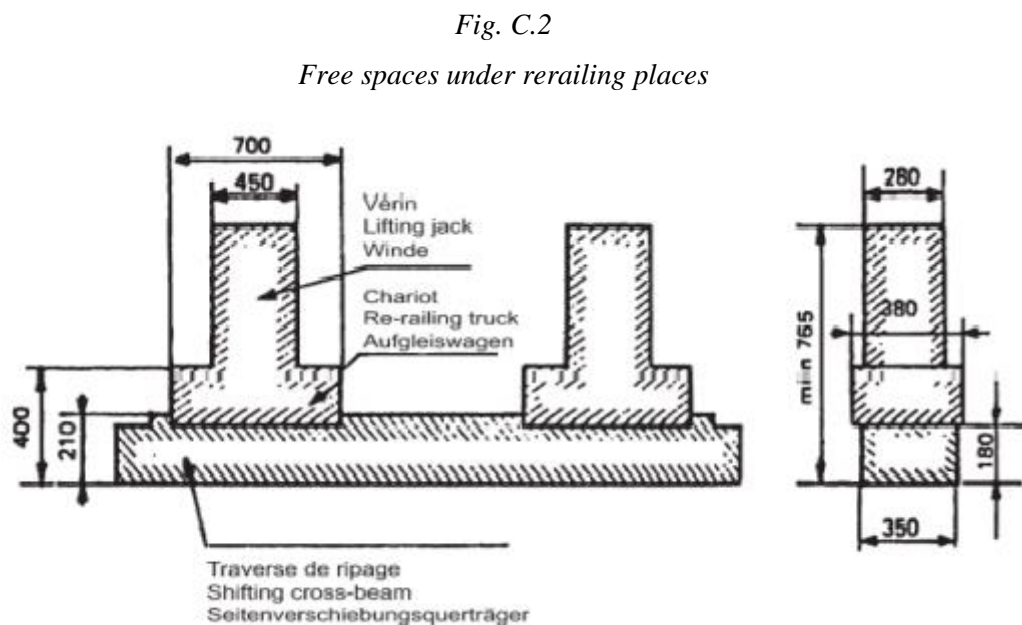

 <b>OTIF</b>	<b>ROLLING STOCK</b> <b>FREIGHT WAGONS</b>		<b>UTP WAG</b> Page 84 of 151	
	Status: <b>PROPOSAL</b>		TECH-20005 Annex	Original: EN

## 5. Marking of units

~~Markings of EN 15877 1:2012 are required where applicable. The following are always applicable:~~

- ~~4.5.2 Gauge marking~~
- ~~4.5.3 Vehicle Tare Weight~~
- ~~4.5.4 Vehicle load table~~
- ~~4.5.5 Sign for length over buffers~~
- ~~4.5.12 Table of Maintenance dates~~
- ~~4.5.14 Lifting and re-railing signs~~
- ~~4.5.23 Distances between end axles and bogie centres~~
- ~~4.5.29 Brake weight~~

Units compliant with all requirements set out in section 4.2, fulfilling all conditions set out in point 7.1.2 and all conditions set out in Appendix C may receive the marking “GE”.

Wagons of the existing fleet which have been authorised in the EU in accordance with

- Commission Decision 2006/861/EC as amended by Decision 2009/107/EC or with
- Decision 2006/861/EC as amended by Decisions 2009/107/EC and 2012/464/EU and meeting the conditions set out in point 7.6.4 of Decision 2009/107/EC,

Or which have been admitted to operation in accordance with

- UTP WAG with reference A 94-02/3.2011 of 1.12.2012 and meeting the conditions set out in point 7.6.4 of that UTP,

-may receive this marking “GE” without any additional third party assessment or new admission to operation. The use of this marking on wagons in operation remains

<sup>(59)</sup>

*(c) with regards to the marking “GE” as depicted in point 5 of Appendix C of the Annex, wagons of the existing fleet which have been authorised in accordance with Commission Decision 2006/861/EC as amended by Decision 2009/107/EC or with Decision 2006/861/EC as amended by Decisions 2009/107/EC and 2012/464/EU and meeting the conditions set out in point 7.6.4 of Decision 2009/107/EC may receive this marking “GE” without any additional third party assessment or new authorisation for placing on the market. The use of this marking in wagons in operation remains under the responsibility of the railway undertakings. ~~wagons of the existing fleet which have been authorised in accordance with Commission Decision 2006/861/EC as amended by Decision 2009/107/EC or with Decision 2006/861/EC as amended by Decisions 2009/107/EC and 2012/464/EU and meeting the conditions set out in point~~*

<sup>59</sup> Article 3(c) of Commission Regulation (EU) No 321/2013 enacting the WAG TSI as lastly amended by Commission Implementing Regulation (EU) 2019/776 of 16 May 2019

 <b>OTIF</b>	<b>ROLLING STOCK</b> <b>FREIGHT WAGONS</b>		<b>UTP WAG</b> Page 85 of 151	
	Status: <b>PROPOSAL</b>		TECH-20005 Annex	Original: EN

under the responsibility of the railway undertakings.

~~7.6.4 of Decision 2009/107/EC may receive this marking “GE” without any additional third party assessment or new authorisation for placing in service. The use of this marking in wagons in operation remains under the responsibility of the railway undertakings.~~

Units compliant with all requirements set out in section 4.2, fulfilling all conditions in point 7.1.2 and the conditions set out in Appendix C but not those set out in Appendix C sections 3 and/or 6 and/or 7.b [and/or 8.a20](#) may receive the marking “CW”.

If the additional marking is used, it shall be inscribed on the unit as outlined in figure C.3.

*Fig. C.3*

*The additional markings “GE” and “CW”*



The letters shall be of the same font type as the TEN marking. The size of the letters shall be at least 100 mm high. The outer measures of the frame shall be at least 275 mm wide and 140 mm high, the frame shall be 7 mm thick.

The marking shall be located on the right hand side of the area containing the European Vehicle Number and the TEN marking.

## 6. G1 gauge

The reference contour with which the unit complies with shall be G1 and G1~~E~~ determined as defined in point 4.2.3.1.

## 7. Compliance with core UTP/TSI regarding train detection systems

(a) The unit shall be compatible with the train detection systems based on track circuits, on axle counters and on loop equipment as specified in

section 7.1.2 (h), with the values as defined in Appendix H.<sup>60</sup>

clauses 4.2.3.3(a), 4.2.3.3(b) and 4.2.3.3(c).

(b) The distance between two adjacent axles of the unit shall not exceed 17500 mm.

## 8. Tests concerning longitudinal compressive forces

<sup>60</sup> According to clause 7.1.2 and Appendix H, the distance between two adjacent axles shall not exceed 20000 mm and CW wagons must comply with this value. For wagons marked GE, this value in clause 7.1.2 and Appendix H is made stricter by the maximum value 17500 mm, as set out in point (b).



 <b>OTIF</b>	<b>ROLLING STOCK</b> <b>FREIGHT WAGONS</b>		<b>UTP WAG</b> Page 86 of 151	
	Status: <b>PROPOSAL</b>		TECH-20005 Annex	Original: EN

The verification of safe running under longitudinal compressive forces shall be in accordance with EN 15839:2012+A1:2015.

## 9. UIC brake

The brake system shall be compatible with vehicles equipped with UIC approved brake systems. The brake system of a unit is compatible with the UIC brake system if it fulfils the following requirements:

- (a) The unit shall be equipped with a pneumatic brake pipe with an inner diameter of 32 mm.
- (b) Brake modes have different brake application and release times and specific brake weight percentage.
- (c) Every unit shall be fitted with a brake system having at least brake modes G and P. The brake modes G and P shall be assessed in accordance with UIC 540:2014~~06~~.
- (d) The minimum braking performance for brake-modes G and P shall be in accordance with table C.3.
- (e) If a unit is equipped with a brake system having in addition further brake modes the assessment procedure as described in point 4.2.4.3.2.1 shall be carried out for these additional brake modes. The brake application time of the P brake mode in accordance with UIC 540:2014~~06~~ are also valid for further brake modes.
- (f) The energy storage has to be designed in such way that after a brake application with the maximum brake cylinder pressure and the maximum unit specific brake cylinder stroke at any load state the pressure in the auxiliary reservoir must be at least 0,3 bar more than the brake cylinder pressure without the addition of any further energy. Details for standardised air reservoirs are set out in EN 286-3:1994 (steel) and EN 286-4:1994 (aluminium).
- (g) The pneumatic energy of the brake system shall not be used for other applications different than those related to braking purposes.
- (h) The distributor and distributor isolating device shall be in accordance with EN 15355:2008+A1:2010. At least one distributor shall be installed per 31m unit length.
- (i) The pneumatic half coupling and its hose:
  - (i) The interface of the brake pipe shall be in accordance with EN 15807:2011.
  - (ii) The opening of the automatic air brake coupling head shall face the left when looking at the end of the vehicle.
  - (iii) The opening of the main reservoir coupling head shall face the right when looking at the end of the unit.
  - (iv) The end cocks shall be in accordance with EN 14601:2005+A1:2010.
- (j) The brake mode switching device shall be in accordance with UIC 541-1:2010 Appendix E.
- (k) Brake block holders shall be in accordance with UIC ~~leaflet~~-542:2015~~0~~.
- (l) If the brake system requires a “friction element for wheel tread brakes” interoperability constituent, the interoperability constituent shall, in addition to the requirements of point 6.1.2.5, comply with UIC leaflet 541-4:2010. The manufacturer of the friction element for wheel tread brakes, or his authorised representative established within the Union, shall in that case obtain the UIC approval.

 <b>OTIF</b>	<b>ROLLING STOCK FREIGHT WAGONS</b>		<b>UTP WAG</b> Page 87 of 151	
Status: <b>PROPOSAL</b>		TECH-20005 Annex	Original: EN	Date: 17.06.2020

- (m) Slack adjusters shall be in accordance with chapters 4 and 5 of EN 16241:2014. The assessment of conformity shall be carried out in accordance with clauses 6.3.2 to 6.3.5 of EN 16241:2014. Additionally, a life test shall be performed to demonstrate the suitability of the slack adjuster for service on the unit and to verify the maintenance requirements for the operational design life. This shall be carried out at the maximum rated load cycling through the full range of adjustment.

~~Appendix N~~

~~ERA technical document  
ERA/TD/201205/INT version 1.0 of  
04.06.2012 published on the ERA  
website (<http://www.era.europa.eu>).~~

- (n) If the unit is equipped with a wheel slide protection system (WSP) it shall be in accordance with EN 15595:2009+A1:2011.

 <b>OTIF</b>	<b>ROLLING STOCK</b> <b>FREIGHT WAGONS</b>		<b>UTP WAG</b> Page 88 of 151	
	Status: <b>PROPOSAL</b>		TECH-20005 Annex	Original: EN

Table C.3

*Minimum braking performance for brake modes G and P*

Braking mode	Command	unit type	Load status	Requirement for running speed at 100km/h		Requirement for running speed at 120km/h	
				Maximum braking distance	Minimum braking distance	Maximum braking distance	Minimum braking distance
Braking mode "P"	Changeover <sup>(9)</sup>	"S1" <sup>(2)</sup>	Empty	S <sub>max</sub> = 700m λ <sub>min</sub> = 65% <sup>(1)</sup> a <sub>min</sub> =0,60m/s <sup>2</sup> <sup>(1)</sup>	S <sub>min</sub> = 390m, λ <sub>max</sub> =125%, (130%)*, a <sub>max</sub> = 1,15m/s <sup>2</sup>	S <sub>max</sub> = 700m λ <sub>min</sub> = 100% a <sub>min</sub> = 0,88m/s <sup>2</sup>	S <sub>min</sub> =580m, λ <sub>max</sub> = 125%, (130%)*, a <sub>max</sub> =1,08m/s <sup>2</sup>
			Inter-mediate	S <sub>max</sub> = 810m λ <sub>min</sub> = 55% a <sub>min</sub> = 0,51m/s <sup>2</sup>	S <sub>min</sub> = 390m, λ <sub>max</sub> = 125%, a <sub>max</sub> =1,15m/s <sup>2</sup>		
			Loaded	S <sub>max</sub> = 700m λ <sub>min</sub> = 65 % a <sub>min</sub> = 0,60m/s <sup>2</sup>	S <sub>min</sub> = Max [(S = 480m, λ <sub>max</sub> =100%, a <sub>max</sub> = 0,91m/s <sup>2</sup> ), (S obtained with a mean retardation force of 16,5 kN per axle)] <sup>(5)</sup> .		
	Variable load Relay <sup>(10)</sup>	"SS", "S2"	Empty	S <sub>max</sub> = 480m λ <sub>min</sub> = 100% <sup>(1)</sup> a <sub>min</sub> =0,91m/s <sup>2</sup> <sup>(1)</sup>	S <sub>min</sub> = 390m, λ <sub>max</sub> =125%, (130%)*, a <sub>max</sub> = 1,15m/s <sup>2</sup>	S <sub>max</sub> = 700m λ <sub>min</sub> = 100% a <sub>min</sub> = 0,88m/s <sup>2</sup>	S <sub>min</sub> =580m, λ <sub>max</sub> =125%, (130%)*, a <sub>max</sub> =1,08m/s <sup>2</sup>
			Loaded	S <sub>max</sub> = 700m λ <sub>min</sub> = 65 % a <sub>min</sub> = 0,60m/s <sup>2</sup>	S <sub>min</sub> = Max [(S = 480m, λ <sub>max</sub> =100 %, a <sub>max</sub> = 0,91m/s <sup>2</sup> ), (S obtained with a mean retardation force of 16,5 kN per axle)] <sup>(6)</sup> .		
		"SS" <sup>(4)</sup>	Loaded (18t per axle for brake)			S <sub>max</sub> <sup>(8)</sup> = Max [S = 700m, λ <sub>max</sub> =100%, a <sub>max</sub> = 0,88m/s <sup>2</sup> ], (S obtained with a mean retardation force of 16kN per axle)] <sup>(7)</sup> .	
Braking mode "G"				There shall be no separate assessment of the braking performance of units in position G. A unit's braked weight in position G is the result of the braked weight in position P (see UIC 544-1:2014 <del>3</del> )			

\*only for two stage load brake (changeover command) and P10 (cast iron blocks with 10 % phosphor)- or LL-brake blocks

- (1) "a" = ((Speed (Km/h))/3,6)^2/(2x(S-((Te)x(Speed (Km/h)/3,6))))), with Te=2sec.  
Distance calculation EN 14531-1:2001~~5~~ section ~~4.5.11~~
- (2) a unit "S1" is a unit with empty/load device. Maximum load per axle is 22,5 t.
- (3) a unit "S2" is a unit with a variable load relay. Maximum load per axle is 22,5 t.

 <b>OTIF</b>	<b>ROLLING STOCK</b> <b>FREIGHT WAGONS</b>		<b>UTP WAG</b> Page 89 of 151	
	Status: <b>PROPOSAL</b>		TECH-20005 Annex	Original: EN

- (4) a unit “SS” shall be equipped with a variable load relay. Maximum load per axle is 22,5 t.
- (5) The maximum mean retardation force admitted (for running speed at 100km/h) is  $18 \times 0,91 = 16,5$  kN/axle. This value comes from the maximum braking energy input permitted on a clasp braked wheel with a nominal new diameter in the range of [920 mm; 1 000 mm] during braking (the brake weight shall be limited to 18 tonnes/axle).
- (6) The maximum mean retardation force admitted (for running speed at 100km/h) is  $18 \times 0,91 = 16,5$  kN/axle. This value comes from the maximum braking energy input permitted on a clasp braked wheel with a nominal new diameter in the range of [920 mm; 1 000 mm] during braking (the brake weight shall be limited to 18 tonnes/axle). Usually a unit, with  $V_{max} = 100$  km/h and fitted with a variable relay is designed to obtain  $\lambda = 100\%$  up to 14.5 t/axle.
- (7) The maximum mean retardation force admitted (for running speed at 120km/h) is  $18 \times 0,88 = 16$  kN/axle. This value comes from the maximum braking energy input permitted on a clasp braked wheel with a nominal new diameter in the range of [920 mm; 1 000 mm] during braking (the brake weight shall be limited to 18 tonnes). The mass/axle is limited to 20 t/axle and the corresponding  $\lambda$  is 90%. If it is required  $\lambda > 100\%$  with mass/axle  $> 18$  t then it is necessary to consider another kind of brake.
- (8)  $\lambda$  must not exceed 125%, considering for brake only on wheels (brake blocks), the maximum mean retardation force admitted of 16 kN/axle (for running speed at 120km/h).
- (9) Changeover in accordance with EN 15624:2008+A1:2010.
- (10) Variable load relay in accordance with EN 15611:2008+A1:2010 in combination with variable load sensing device in accordance with EN 15625:2008+A1:2010.

## 10. Location of parking brake handles

If a unit is equipped with a parking brake the location of its operating handle or operating wheel shall be:

- on both sides of the unit if it is operated from the ground or
- on a platform, that can be accessed from both sides of the unit.

The operation from the ground shall be done by wheel.

## 11. Temperature ranges for air reservoirs, hoses and grease

The following requirements are deemed to comply with ~~the any temperature~~ range ~~T1~~ indicated in point 4.2.5.

- Air reservoirs shall be designed for the temperature range of  $-40^{\circ}\text{C}$  to ~~+10~~+7 $0^{\circ}\text{C}$ .
- Brake cylinders and brake couplings shall be designed for the temperature range of  $-40^{\circ}\text{C}$  to  $+70^{\circ}\text{C}$ .
- Hoses for air brakes and air supply shall be specified for the temperatures range  $-40^{\circ}\text{C}$  to  $+70^{\circ}\text{C}$ .

The following requirement is deemed to comply with the range T1 indicated in point 4.2.5:

- The grease for the lubrication of roller bearing shall be specified for ambient temperatures down to  $-20^{\circ}\text{C}$ .

## 12. Welding

 <b>OTIF</b>	<b>ROLLING STOCK</b> <b>FREIGHT WAGONS</b>		<b>UTP WAG</b> Page 90 of 151	
	Status: <b>PROPOSAL</b>		TECH-20005 Annex	Original: EN

~~Welding shall be carried out in accordance with EN 15085-1-5:2007~~ [Welding shall be carried out in accordance with EN 15085-1:2007+A1:2013, EN 15085-2:2007, EN 15085-3:2007, EN 15085-4:2007 and EN 15085-5:2007.](#)

**13. Track gauge**

The unit shall be compatible with the 1435 mm track gauge.

**14. Specific brake thermal capacity**

The brake system shall resist a thermal load equivalent to the suggested reference case in point 4.2.4.3.3.

With regard to the use of wheel tread brake systems this condition is deemed to be met, if the “friction elements for wheel tread brakes” interoperability constituent is, in addition to the requirements of point 6.1.2.5, compliant with UIC leaflet 541-4:2010, and if the wheel:

- is assessed in accordance with point 6.1.2.3 and
- fulfils the conditions of Section 15 of Appendix C.

**15. Specific product properties concerning the wheel**

The wheels shall be in accordance with EN 13262:2004+A1:2008+A2:2011 and EN 13979-1:2003+A1:2009+A2:2011. The thermal mechanical type test required in point 6.1.2.3 shall be carried out in accordance with table C.4 when the complete brake system is acting directly on the wheel tread.

*Table C.4*

*Conditions for the thermal mechanical type test*

<b>Wheel diameter range [mm]</b>	<b>1000 - 920</b>	<b>920 - 840</b>	<b>840 - 760</b>	<b>760 - 680</b>
Standard power value	50 kW	50 kW	42,5 kW	38 kW
Application time	45 min	45 min	45 min	45 min
Running speed	60 km/h	60 km/h	60 km/h	60 km/h

**16. Tow hooks**

Units shall be provided with tow hooks, each one being fixed to the side of the unit underframe in accordance with clause 1.4 of UIC 535-2:2006.

[Alternative technical solutions are allowed as far as conditions 1.4.2 to 1.4.9 of UIC 535-2:2006 are respected. If the alternative solution is a cable eye bracket, it shall in addition have a minimum diameter of 85 mm.](#)

**17. Protective devices on protruding parts**

To ensure the safety of staff, protruding (e.g. angular or pointed) parts of the unit located up to 2 m above rail level or above passageways, working surfaces or tow hooks which are liable to cause accidents, shall be fitted with protective devices as described in clause 1.3 of UIC 535-2:2006

**18. Label holders and attachment devices for rear end signal**

 <b>OTIF</b>	<b>ROLLING STOCK FREIGHT WAGONS</b>		<b>UTP WAG</b> Page 91 of 151	
Status: <b>PROPOSAL</b>		TECH-20005 Annex	Original: EN	Date: 17.06.2020

All units shall be equipped with a label holder in accordance with clause 1 of UIC 575:1995 and at both ends with attachment devices as set out in point 4.2.6.3.

**19. Axle bearing condition monitoring**

It shall be possible to monitor the axle bearing condition of the unit by means of line side detection equipment.

**20. Running dynamic behaviour**

The combination of maximum operating speed and maximum admissible cant deficiency shall be as shown in table H.1 of EN 14363:2016.

Units equipped with established running gear as described in chapter 6 of EN 16235:2013 are presumed to be in conformity with this requirement.

 <b>OTIF</b>	<b>ROLLING STOCK</b> <b>FREIGHT WAGONS</b>		<b>UTP WAG</b> Page 92 of 151	
	Status: <b>PROPOSAL</b>		TECH-20005 Annex	Original: EN

**Appendix D: Mandatory Standards or normative documents referred to in this UTP/TSI**

<b>UTP/TSI</b>		<b>Standard/document</b>	
<b>Characteristics to be assessed</b>		<b>References to <del>mandatory</del> Standard or document</b>	<b>Clauses</b>
<b>Structure and mechanical part</b>	<b>4.2.2</b>		
Strength of unit	4.2.2.2	EN12663-2:2010	5
		EN 15877-1:2012	4.5. <del>13</del> 14
	6.2.2.1	<a href="#">EN 12663-1:2010+A1:2014</a>	<a href="#">9.2</a>
		EN 12663-2:2010	6, 7
<del>Vehicle Gauging and track interaction and gauging</del>	<b>4.2.3</b>		
Gauging	4.2.3.1	EN 15273-2:2009 <del>13</del> <a href="#">A1:2016</a>	all
Compatibility with load carrying capacity of lines	4.2.3.2	EN 15528:2015 <del>98</del>	6.1, 6.2
<a href="#">Compatibility with train detection systems</a>	<a href="#">4.2.3.3</a>	<a href="#">ERA Technical document ERA/ERTMS/033281 rev.04</a> The relevant specifications in the scope of this UTP are included in Appendix H to this UTP	<a href="#">See Appendix H</a>
Axle bearing condition monitoring	4.2.3.4	EN 15437-1:2009	5.1, 5.2
Safety against derailment running on twisted track	4.2.3.5.1	-	-
	6.2.2.2	EN 14363:2005 <del>2016</del> EN 15839:2012	4. <del>5. 6.1.1</del> <del>4.2</del>
	4.2.3.5.2	EN 14363:200 <del>165</del>	<a href="#">4. 5. 7</a>
Running dynamic behaviour	<a href="#">6.1.2.1</a>	<a href="#">EN 16235:2013</a>	<a href="#">4. 5. 7</a>
	6.2.2.3	<del>EN 14363:2005</del> <a href="#">EN 16235:2013</a> EN 15687:2010 EN 15827:2011	<del>5</del> all <del>5.3.2.2</del> <del>9.3</del>
	6.1.2.1	<del>Content of prEN 16235 included in Appendix B of this UTP (The TSI refers to ERA technical document ERA/TD/2013/01/INT version 1.0 of 11.02.2013, of which the contents are identical to Appendix B)</del> <a href="#">EN 13749:2011</a>	<del>all</del> <a href="#">6.2</a>
	4.2.3.6	-	-
	<del>6.1.2.1</del>	<del>EN 13749:2011</del> <del>Content of prEN 16235 included in Appendix B of this UTP (The TSI refers to ERA technical document ERA/TD/2013/01/INT version 1.0 of 11.02.2013, of which the contents are identical to Appendix B)</del>	<del>6.2</del> all
Structural design of bogie frame	4.2.3.6.1	EN 13749:2011	6.2
	6.1.2.-1	EN 13749:2011	6.2
Characteristics of wheelsets	4.2.3.6.2	-	-
	6.1.2.-2	EN 13260:2009+A1:2010	3.2.1
Characteristics of wheels	4.2.3.6.3	-	-
	6.1.2.3	EN 13979-1:2003+A1:2009 +A2:2011	7, 6.2

 <b>OTIF</b>	<b>ROLLING STOCK</b> <b>FREIGHT WAGONS</b>		<b>UTP WAG</b> Page 93 of 151	
	Status: <b>PROPOSAL</b>		TECH-20005 Annex	Original: EN

<b>UTP/TSI</b>		<b>Standard/document</b>	
<b>Characteristics to be assessed</b>		<b>References to <del>mandatory</del> Standard or document</b>	<b>Clauses</b>
Characteristics of axles	4.2.3.6.4	-	-
	6.1.2.4	EN 13103:2009+A2:2012	4, 5, 6, 7
Axle boxes / bearings	4.2.3.6.5	-	-
	6.2.2.4	EN 12082:2007+A1:2010	6
Running gear for manual change of wheelsets	4.2.3.6.7	-	-
	6.2.2.5	UIC 430-1:2012 UIC 430-3:1995	Ann. B, H, I Ann. 7
<b>Brake</b>	<b>4.2.4</b>		
<del>In-s</del> Service brake	4.2.4.3.2.1	EN 14531-6:2009	All
		UIC 544-1:2014 <del>3</del>	All
Parking brake	4.2.4.3.2.2	EN 14531-6:2009 <del>EN 15877-1:2012</del>	6 4.5.25
Friction elements for wheel tread brakes	4.2.4.3.5	-	-
	6.1.2.5	ERA technical document ERA/TD/2013-02/INT version <del>23.0</del> of <del>XX.XX.2014</del> <del>27.11.2015</del>	All
<b>Environmental conditions</b>	<b>4.2.5</b>		
Environmental conditions	4.2.5	EN 50125-1:2014 <del>1999</del>	4.7
	6.2.2.7	-	-
<b>System protection</b>	<b>4.2.6</b>		
<del>Fire safety - b</del> Barriers	4.2.6.1.2.1	-	-
	6.2.2.8.1	EN 1363-1:2012 <del>1999</del>	All
<del>Fire safety - m</del> Materials	4.2.6.1.2.2	-	-
	6.2.2.8.2	ISO 5658-2:2006/Am1:2011	All
		EN 13501-1:2007+A1:2009	All
		<del>EN 45545-2:2013+A1:2015</del>	Table 6
		ISO 5660-1:2015	All
<del>Fire safety - e</del> Cables	6.2.2.8.3	EN 50355:2010 <del>3</del>	All
		EN 50343:2014 <del>03</del>	All
<del>Fire safety</del> Flammable liquids	6.2.2.8.4	<del>TS</del> EN 45545-7:2009 <del>13</del>	All
Protection <del>ve measures</del> against <del>el. hazard</del> - indirect contact ( <del>protective bonding</del> )	4.2.6.2.2.1	EN 50153:2014 <del>02</del>	6.4
Protection <del>ve measures</del> against <del>el. hazard</del> - direct contact	4.2.6.2.2.2	EN 50153:2014 <del>02</del>	5
Attachment devices for rear-end signals	4.2.6.3	Appendix J (The TSI refers to ERA technical document ERA/TD/2012-04/INT version 1.2 of 18.01.2013) <del>EN 16116- 2:2013</del>	Chapter <del>1</del> Figure 11



 <b>OTIF</b>	<b>ROLLING STOCK</b> <b>FREIGHT WAGONS</b>		<b>UTP WAG</b> Page 94 of 151
	Status: <b>PROPOSAL</b>	TECH-20005 Annex	Original: EN

**Standards and documents referred to in the additional optional conditions set out in Appendix C:**

Additional optional conditions for units	App. C	Standard / UIC leaflet / document	
Manual coupling system	C.1	EN 15566:2009+A1:2010	All <a href="#">except 4.4</a>
		EN 15551:2009+A1:2010	All <a href="#">6.2, 6.2.3.1</a>
		<del>Appendices K and L (The TSI refers to ERA technical document ERA/TD/2012-04/INT version 1.2 of 18.01.2013)</del> EN 16116-2:2013	<a href="#">Chapters 2 and 36.2.1, 6.3.2</a>
		EN15877-1:2012	Figure 75
UIC footsteps and handrails	C.2	<del>Appendix M (The TSI refers to ERA technical document ERA/TD/2012-04/INT version 1.2 of 18.01.2013)</del> EN 16116-2:2013	<a href="#">Chapter 4, 5, 6.2.2</a>
Ability to be hump shunted	C.3	EN 12663-2:2010	5, 8
<del>Marking of units (RIV)</del>	<del>C.5</del>	<del>EN15877-1:2012</del>	<del>all</del>
Tests concerning longitudinal compressive forces	C.8	EN 15839:2012+A1:2015	All
UIC brake	C.9	EN 15355:2008+A1:2010	All
		EN 15611:2008+A1:2010	All
		UIC 540:2014 <del>06</del>	All
		EN 14531-1:201 <del>05</del>	<a href="#">4.5.11</a>
		EN 15624:2008+A1:2010	All
		EN 15625:2008+A1:2010	All
		EN 286-3:1994	All
		EN 286-4:1994	All
		EN 15807:2011	All
		EN 14601:2005+A1:2010	All
		UIC <del>541</del> -1:201 <del>5</del> <del>40</del>	<a href="#">Ann. E all</a>
		UIC <del>leaflet-542:201</del> <del>50</del>	All
		UIC 541-4:2010	All
		<del>Appendix N (The TSI refers to ERA technical document ERA/TD/2012-05/INT version 1.0 of 04.06.2012)</del> EN 16241:2014	<a href="#">4, 5, 6.3.2 to 6.3.5 all</a>
EN 15595:2009+A1:2011	All		
Welding	C.12	EN 15085-1- <del>5</del> :2007+A1:2013	All
		EN 15085-2:2007	All
		EN 15085-3:2007	All
		EN 15085-4:2007	All
		EN 15085-5:2007	All
Specific product properties concerning the wheel	C.15	EN 13262: 2004 +A1:2008+A2:2011	All
		EN 13979-1:2003 +A1:2009+A2:2011	All
Tow hooks	C.16	UIC 535-2:2006	1.4
Protective devices on protruding parts	C.17	UIC 535-2:2006	1.3
<del>Label</del> Label holders and attachment devices for rear end signal	C.18	UIC 575:1995	1

 <b>OTIF</b>	<b>ROLLING STOCK</b> <b>FREIGHT WAGONS</b>		<b>UTP WAG</b> Page 95 of 151
	Status: <b>PROPOSAL</b>	TECH-20005 Annex	Original: EN

## Appendix E: Rear-end signal

### 1. Lamps

The colour of tail lamps shall be in accordance with clause 5.5.3 of EN 15153-1:2013+A1:2016.

The tail lamp shall be designed to display a lighting intensity in accordance with table 8 of EN 15153-1:2013+A1:2016. ~~The lamp shall display a luminous area of at least 170 mm diameter. The reflector system shall be designed to display a lighting strength of at least 15 candela of red light along the axis of the lighting surface for an angle of opening of 15° horizontally and 5° vertically. The intensity must be at least 7.5 candela of red light.~~

The lamp shall be suitable to be attached to units complying with the attachment devices and the clearance set out in point 4.2.6.3. The lamp shall be equipped with:

- a switch (on/off)
- a warning light which indicates the battery status.

### 2. Reflective plates

The reflective plates shall be suitable to be attached to units complying with the attachment devices and the clearance set out in point 4.2.6.3. The reflective section of the plates shall be at least 150 by at least 200 mm as illustrated in figure E.1. The side triangles shall be white, the top and the bottom triangles shall be red. The plate shall be retro-reflective in accordance with EN 12899-1:2007 Class Ref. 2.

*Fig. E.1*

*Reflective plate*

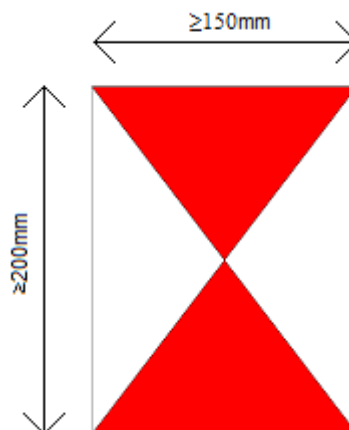

 <b>OTIF</b>	<b>ROLLING STOCK</b> <b>FREIGHT WAGONS</b>		<b>UTP WAG</b> Page 96 of 151	
	Status: <b>PROPOSAL</b>	TECH-20005 Annex	Original: EN	Date: 17.06.2020

## Appendix F: Assessment assigned to the production phases

Table F.1

### *Assessment assigned to the production phases*

Characteristics to be assessed, as specified in section 4.2		Design and development phase		Production phase	Particular assessment procedure
		Design review	Type Test	Routine Test	
Element of the Rolling Stock sub-system	Point				Point
<b>Structure and mechanical part</b>		<b>4.2.2</b>			
End coupling	4.2.2.1.1	X	n.a.	n.a.	-
Inner coupling	4.2.2.1.2	X	n.a.	n.a.	-
Strength of unit	4.2.2.2	X	X	n.a.	6.2.2.1
Integrity of the unit	4.2.2.3	X	n.a.	n.a.	-
<b>Vehicle track interaction and gauging</b>		<b>4.2.3</b>			
Gauging	4.2.3.1	X	n.a.	n.a.	-
Compatibility with load carrying capacity of lines	4.2.3.2	X	X	n.a.	-
Compatibility with train detection systems	4.2.3.3	X	X	n.a.	-
Axle bearing condition monitoring	4.2.3.4	X	X	n.a.	-
Safety against derailment running on twisted track	4.2.3.5.1	X	X	n.a.	6.2.2.2
Running dynamic behaviour	4.2.3.5.2	X	X	n.a.	6.1.2.1 / 6.2.2.3
Structural design of bogie frame	4.2.3.6.1	X	X	n.a.	6.1.2.1
Characteristics of wheelsets	4.2.3.6.2	X	X	X	6.1.2.2
Characteristics of wheels	4.2.3.6.3	X	X	X	6.1.2.3
Characteristics of axles	4.2.3.6.4	X	X	X	6.1.2.4
Axle boxes / bearings	4.2.3.6.5	X	X	X	6.2.2.4
<u>Automatic</u> <del>V</del> variable gauge <del>wheelsets</del> system	4.2.3.6.6	<del>X</del> open	<del>X</del> open	<del>X</del> open	<del>open</del> 6.1.2.6/6.2.2.4a
Running gear for manual change of wheelsets	4.2.3.6.7	X	X	n.a.	6.2.2.5
<b>Brake</b>		<b>4.2.4</b>			
Safety requirements	4.2.4.2	X	n.a.	n.a.	-
Functional and technical requirements	4.2.4.3	X	X	n.a.	-
In-service brake	4.2.4.3.2 .1	X	X	n.a.	-
	4.2.4.3.2 .2	X	n.a.	n.a.	-
Parking brake	4.2.4.3.2 .2	X	n.a.	n.a.	-
Thermal capacity	4.2.4.3.3	X	X	n.a.	6.2.2.6
Wheel slide protection (WSP)	4.2.4.3.4	X	X	n.a.	-
Friction elements for wheel tread brakes	4.2.4.3.5	X	X	X	6:1:2:5
<b>Environmental conditions</b>		<b>4.2.5</b>			
Environmental conditions	4.2.5	X	n.a. /X <sup>(1)</sup>	n.a.	6.2.2.7
<sup>(1)</sup> Type test if and as defined by the applicant					
<b>System protection</b>		<b>4.2.6</b>			
Fire safety	4.2.6.1	X	X	n.a.	6.2.2.8
Protection against electric hazard	4.2.6.2	X	X	n.a.	-
Attachment devices for rear end signal	4.2.6.3	X	X	n.a.	-

 <b>OTIF</b>	<b>ROLLING STOCK FREIGHT WAGONS</b>		<b>UTP WAG</b> Page 97 of 151
Status: <b>PROPOSAL</b>		TECH-20005 Annex	Original: EN Date: 17.06.2020

**Appendix G: list of fully approved composite brake blocks for international transport**

This Appendix is the “List of fully approved composite brake blocks for international transport”, reference: ERA/TD/2009-02/INT version 145.0 of ~~2023 January~~ ~~July~~ 2015.

This Appendix is published on the ERA website (<http://www.era.europa.eu>).

 <b>OTIF</b>	<b>ROLLING STOCK</b> <b>FREIGHT WAGONS</b>		<b>UTP WAG</b> Page 98 of 151	
	Status: <b>PROPOSAL</b>		TECH-20005 Annex	Original: EN

## **Appendix H: Interfaces with control- command and signalling systems**

*This appendix is based on ERA document ERA/ERTMS/033281 rev. 4.0 as published on the ERA website and as referred to in the WAG TSI. The parameters in the Appendix define the interface between trains and train detection systems. The parameters and values are limited to those relevant for freight wagons within the technical scope of this UTP as defined in point 1.1. This Appendix appears in full width for readability. For corresponding EU texts see ERA document ERA/ERTMS/033281 rev. 4.0*

.

Axle distances (these values are used to define the distance between two consecutive axles in a train):

- For 1435 mm, 1600 mm and 1668 mm track gauges, the greatest distance between two consecutive axles shall not exceed 20,000 mm. For 1520 mm and 1524 mm track gauges the greatest distance between two consecutive axles shall not exceed 19,000 mm
- The shortest distance between two consecutive axles [in mm] shall not be less than 7.2 times the maximum operational speed in km/h with a minimum of 720mm.
- The distance between the end axles of the wagon shall not be less than 3,000 mm
- For 1435 mm, 1524 mm, 1600 mm and 1668 mm track gauges, the distance between the end of the vehicle (e.g. buffer) and the first axle of the unit shall not exceed 4,200 mm. For 1520 mm track gauge the distance shall not exceed 3,500 mm.

Impedance between wheels:

- The electrical resistance between the running surfaces of the opposite wheels of a wheelset shall not exceed 0.05 Ohm, measured at a voltage of between 1.8 VDC and 2.0 VDC (open circuit).

<sup>(61)</sup>

### ~~3.1.2.1. Maximum axle distance~~

~~Harmonised parameter:~~

~~The distance  $a_i$  (Fig. 1) does not exceed 20 000 mm.~~

### ~~3.1.2.2. Minimum axle distance (1)~~

~~Harmonised parameter:~~

~~For the maximum speed  $v$  lower or equal to 350 km/h: The distance  $a_i$  (Fig.1) is  $a_i \geq v \times 7,2$  (where  $v$  is in km/h and distance  $a_i$  is in mm)~~

### ~~3.1.2.4. Minimum axle distance (3)~~

~~Harmonised parameter:~~

~~The distance between first and last axle  $L = (b1 + b2)$  (Fig.1) is at least 3 000 mm~~

### ~~3.1.2.6. Distances between end of train and first axle on other lines~~

~~Harmonised parameter:~~

~~The distance  $b_x$  (Fig. 1) does not exceed 4 200 mm.~~

### ~~3.1.9. Impedance between wheels~~

~~Harmonised parameter:~~

- ~~The electrical resistance between the running surfaces of the opposite wheels of a wheelset does not exceed 0.05 Ohm, measured by a voltage between 1.8 VDC and 2.0 VDC (open circuit).~~

<sup>61</sup> The corresponding EU requirements are set out in Annex A, index 77 of Decision 2012/88/EU (CCS TSI), which refers to ERA document ERA/ERTMS/033281 version 4.0. Only the specifications relevant to freight wagons within the scope of this UTP are listed.

 <b>OTIF</b>	<b>ROLLING STOCK</b> <b>FREIGHT WAGONS</b>		<b>UTP WAG</b> Page 99 of 151	
	Status: <b>PROPOSAL</b>		TECH-20005 Annex	Original: EN

Wheel Geometry:

- Minimum wheel rim width shall be as specified in section 4.2.3.6.3 “Characteristics of wheels” of this UTP.
- The wheel diameter of hooped and massive wheels shall not be less than 330 mm for wagons with a maximum operational speed of 100 km/h or less. For wagons with a maximum operational speed of more than 100 km/h, the wheel diameter ~~[mm]~~ shall not be less than 150 mm + 1.8 times the maximum operational speed in km/h. The wheel diameter of spoked wheels shall be at least 600 mm.
- Minimum flange thickness shall be as specified in section 4.2.3.6.3 “Characteristics of wheels” of this UTP
- Flange height shall be as specified in section 4.2.3.6.3 “Characteristics of wheels” of this UTP

The metal-free space around wheels:

- Only wheels and their parts (gearboxes, brake parts, etc.) or non-ferromagnetic and non-inductive components shall be mounted in the area defined in figure 3H.1.

*3.1.3.1. Minimum wheel rim width*

*Harmonised parameter:*

- ~~The dimension  $B_R$  (Fig. 2) is at least 133 mm.~~

*3.1.3.2. Minimum wheel diameter*

*Harmonised parameter:*

- ~~For the maximum speed  $v$ , the dimension  $D$  (Fig. 2) is at least~~

$v$ [km/h]	$D$ [mm]
$v \leq 100$	330
$100 < v \leq 250$	$150 + 1.8 \cdot v$

*3.1.3.3. Minimum flange thickness*

*Harmonised parameter:*

- ~~The dimension  $S_d$  (Fig. 2) is at least:~~
  - ~~1. 27.5 mm if the dimension  $D$  (Fig. 2) does not exceed 840 mm~~
  - ~~2. 20.0 mm if the dimension  $D$  (Fig. 2) is more than 840 mm~~

*3.1.3.4. Flange height*

*Harmonised parameter:*

- ~~The range of the dimension  $S_h$  (Fig. 2) is 27.5—36 mm~~

*3.1.3.5. Metal and inductive components free space between wheels*

*Harmonised parameter:*

- ~~For freight wagons: only wheels and their parts (gearboxes, brake parts, sanding tube) or non-ferromagnetic and non-inductive components are mounted in the sensitive area of Fig. 3.~~

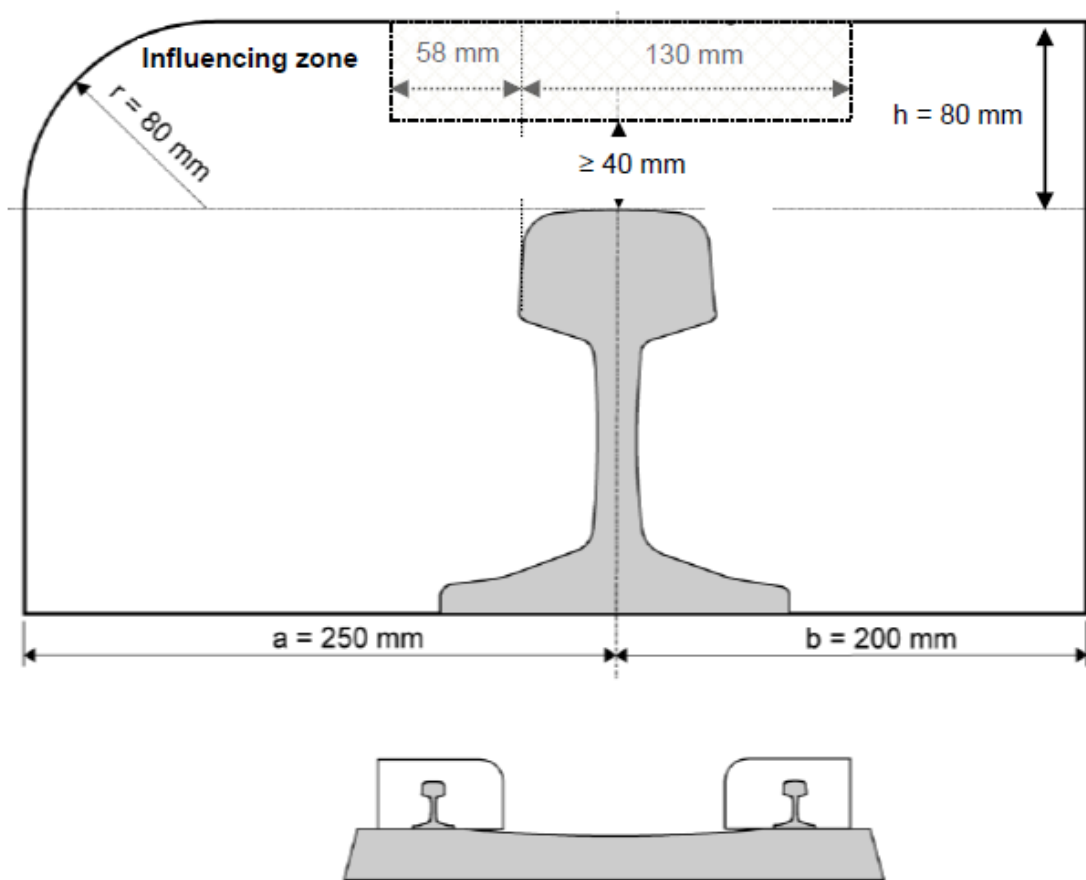
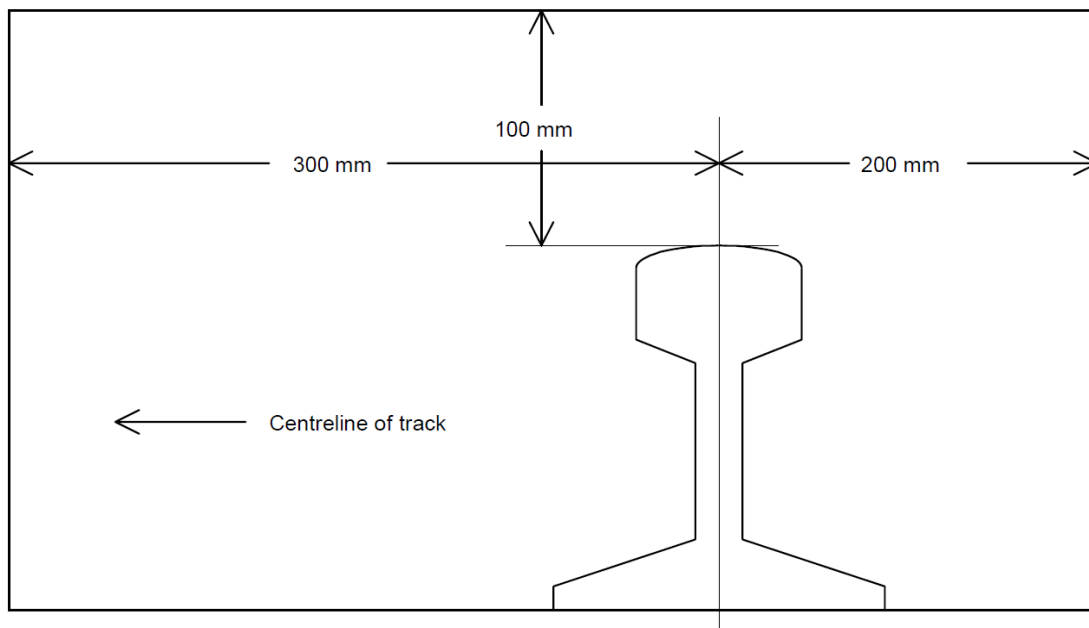



Figure 3H.1

The characteristics of the wheel material regarding magnetic fields:

*3.1.3.6. Wheel material*  
*Harmonised parameter:*

 <b>OTIF</b>	<b>ROLLING STOCK FREIGHT WAGONS</b>		<b>UTP WAG</b> Page 101 of 151	
Status: <b>PROPOSAL</b>		TECH-20005 Annex	Original: EN	Date: 17.06.2020

- The wheels shall have ferromagnetic characteristics ( ~~$\mu_r > 300$~~ ) and shall be electrically conductive.

#### Use of composite brake blocks

- If brake blocks are fitted ~~The vehicles shall use brake blocks~~ these shall be assessed for the effects on the contact resistance between wheel and rail. Brake blocks listed in the list referred to in Appendix G of this UTP are deemed to be in conformity with this requirement.

#### Load and mass:

- For 1435 mm, 1524 mm, 1600 mm and 1668 mm track gauges, ~~The~~ minimum axle load in all load conditions shall be 3.5t for wagons with more than 4 axles and wheel tread ~~brakes~~ blocks; 4t for wagons with 4 axles and wheel tread ~~brakes~~ blocks, 5t for other wagons. For 1520 mm track gauge the axle load shall be at least 11t for all types of wagons.

#### Use of shunt assisting devices

- For 1520 mm track gauges the use of shunting assisting devices is required for axle loads less than 11t.

#### ~~The metal mass of the vehicle:~~

- ~~The metal mass of a wagon is an open point for the interface with loop detection systems.~~

- ~~The wheels have ferromagnetic characteristics ( $\mu_r > 300$ ) and are electrically conducting.~~

#### ~~3.1.6. Use of composite brake blocks~~

##### ~~Harmonised parameter:~~

- ~~The vehicles use brake blocks assessed for the effects on the contact resistance between wheel and rail.~~

#### ~~3.1.7.1. Axle load~~

##### ~~Harmonised parameter:~~

##### ~~The axle load is~~

- ~~1. at least 5 t generally for vehicles with 2 axles and more,~~
- ~~2. at least 4 t for vehicles with 4 axles and brake blocks,~~
- ~~3.1. at least 3,5 t for vehicles with more than 4 axles and brake blocks.~~

#### ~~3.1.7.2. Vehicle metal mass~~

##### ~~Harmonised parameter:~~

- ~~The metal mass of a vehicle is: [open point].~~



 <b>OTIF</b>	<b>ROLLING STOCK</b> <b>FREIGHT WAGONS</b>		<b>UTP WAG</b> Page 102 of 151
	Status: <b>PROPOSAL</b>	TECH-20005 Annex	Original: EN

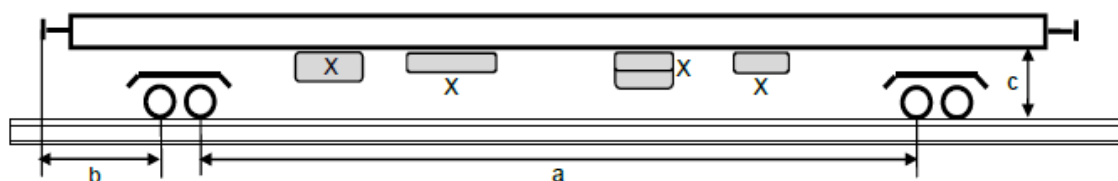

A: Defined distances and areas (the illustrated bogies with two axles are only an example; a bogie can consist of different numbers of axles)

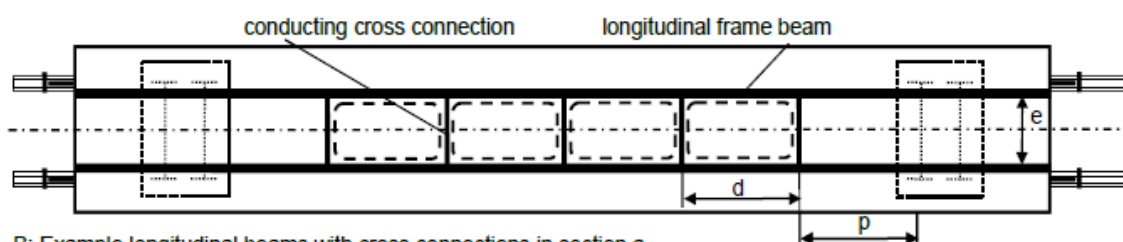

B: Example longitudinal beams with cross connections in section a

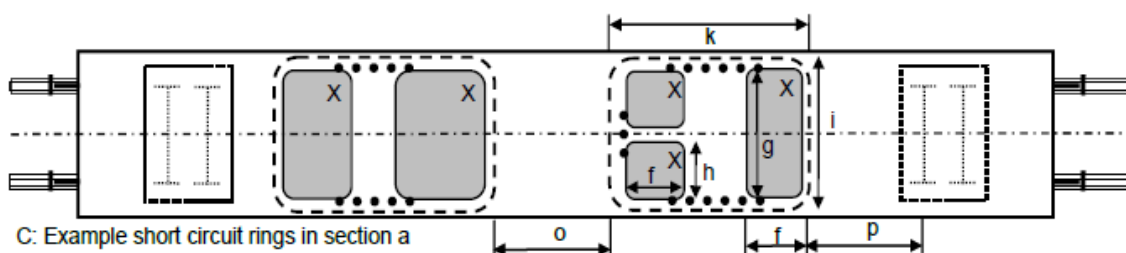

C: Example short circuit rings in section a

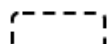
 Resulting short circuit ring (electrically conducting loop)

 Principle routing of the cables for the electrical connection of electrically conductive constituents

*Figure 4H.2*

Harmonised parameter for 1435 mm track gauge:

In the following, “length” refers to the direction in parallel to the track and “width” refers to the direction orthogonal to the track.

The description of this parameter is done with reference to figure 4H.2.

- a: section (distance) between the inner axles of two adjacent bogies or wheel sets
- b: section (distance) between the first (respectively the last) axle and the nearest end of the vehicle (excluding the coupling systems)
- c: distance between top of rail and vehicle floor (bottom side)
- d: distance between adjacent conducting cross connections / length of short circuit

 <b>OTIF</b>	<b>ROLLING STOCK FREIGHT WAGONS</b>		<b>UTP WAG</b> Page 103 of 151
Status: <b>PROPOSAL</b>		TECH-20005 Annex	Original: EN Date: 17.06.2020

rings (electrically conducting loops) formed by frame beams and conducting cross connections

- e: distance of adjacent longitudinal frame beams
- f, g, h: dimensions of electrically connected conducting constituents (X)
- i, k: dimensions of short circuit rings (electrically conducting loops) formed by electrically connected conducting constituents (X)
- o: distance between adjacent short circuit rings
- p: distance between short circuit rings and adjacent wheel sets
- X: conductive constituents mounted below vehicle floor

For the scope of this parameter, the vehicle is subdivided in different sections as shown in Figure 6AH.2 [A]: a central section (a), two outer sections (b) and the sections of the bogies or single wheel sets. The parameter is respected when the design of the vehicle is such that at least one of the conditions 1, 2 or 3 is fulfilled in section (a) and section (b) and condition 4 (or alternatively at least one of the conditions 1, 2 or 3) is fulfilled in the sections of bogies or single wheel sets (in case of vehicles without bogies):

1. The distance (c) between rail level and vehicle floor (bottom side) is less than 1.06 m and the vehicle has a metal floor over its full length (excluding the coupling systems) with a minimum width of 2 m and with a conductivity greater than 1 m/( $\Omega$  mm<sup>2</sup>).

2. The vehicle has constructive structures at least inside section (a) and (b) consisting of longitudinal frame beams symmetrically on both sides with a minimum distance (e) of 1.0 m. These are electrically connected with conducting cross connections in a distance (d) less than or equal to 3 m to form short circuit rings (electrically conducting loops) as illustrated in Figure 6BH.2 [B], showing an example for section (a).

The electrical DC resistance of the resulting short circuit rings is lower than 1  $\Omega$ .

 <b>OTIF</b>	<b>ROLLING STOCK FREIGHT WAGONS</b>		<b>UTP WAG</b> Page 104 of 151
Status: <b>PROPOSAL</b>		TECH-20005 Annex	Original: EN Date: 17.06.2020

The distance (o) between adjacent short circuit rings does not exceed 3 m. The distance (p) between a short circuit ring and an adjacent wheel set of a bogie does not exceed 3 m, the distance to a single wheel set does not exceed 1.5 m.

The distance between rail level and short circuit rings on the bottom side of vehicle floor is less than 1.06 m.

3. The vehicle has electrically conducting constituents (X) mounted below the floor at least inside section (a) and (b). These are electrically connected to form short circuit rings (electrically conducting loops) as illustrated in Figure H.2 [C]6C, showing an example for section (a). The dimensions of the constituents fulfil at least one of the following conditions:

a) minimum width (g) of 2 m and minimum longitudinal length (f) of 1 m,

b) minimum width (h) of 1 m and minimum longitudinal length (f) of 1 m on both long sides of the vehicle.

The electrical connection is done in a way that short circuit rings with a length (k) equal or more than 2.5 m but less or equal than 3 m and a minimum width (i) of 2 m result. Figure H.2 6(C) illustrates the principle routing of the cabling.

The conductivity of the conducting constituents is greater than  $1 \text{ m}/(\Omega \text{ mm}^2)$ . The electrical DC resistance of the resulting short circuit rings is lower than  $1 \Omega$ .

The distance (o) between adjacent short circuit rings does not exceed 3 m. The distance (p) between a short circuit ring and an adjacent wheel set of a bogie does not exceed 3 m, the distance to a single wheel set does not exceed 1.5 m.

The distance between rail level and short circuit rings on the bottom side of vehicle floor is less than 1.06 m.

4. Bogies consist of metal parts with a conductivity greater than  $1 \text{ m}/(\Omega \text{ mm}^2)$ . Constructive supporting metal parts of a bogie frame are electrically connected with an electrical DC resistance lower than  $1 \Omega$ . The distance between rail level and the bottom side

 <b>OTIF</b>	<b>ROLLING STOCK FREIGHT WAGONS</b>		<b>UTP WAG</b> Page 105 of 151	
Status: <b>PROPOSAL</b>		TECH-20005 Annex	Original: EN	Date: 17.06.2020

of the bogie frame is less than 1.06 m.

Alternatively, if these requirements are not fulfilled at least condition 1, 2 or 3 shall be fulfilled in the section of the bogie.

This parameters ensures compatibility with loops.

Other equivalent solutions (e.g. field tests demonstrating that the passing vehicle creates sufficient change of inductivity of trackside loops) to demonstrate compatibility with such trackside loops are allowed.

There are no harmonised parameters for 1520 mm, 1524 mm, 1600 mm and 1668 mm track gauges.

 <b>OTIF</b>	<b>ROLLING STOCK FREIGHT WAGONS</b>		<b>UTP WAG</b> Page 106 of 151	
Status: <b>PROPOSAL</b>		TECH-20005 Annex	Original: EN	Date: 17.06.2020

## Appendix I: Safety management provisions

- The rail transport undertaking operating the train must supply the driver with all the necessary information and documentation required to carry out his duties. This information must take into account the necessary elements for operation in normal, degraded and emergency situations for the routes to be worked over and the rolling stock used on those routes.
- The rail transport undertaking operating the train must supply all members of his staff (whether on train or otherwise) who undertake safety-critical tasks with all the rolling stock specific information it deems appropriate to such tasks. Such information shall be applicable in both normal and degraded operation.
- A process must be defined to ensure the acquisition and retention of vehicle knowledge by the train crew.
- The rail transport undertaking operating the train must provide the required means<sup>63</sup> of indicating the rear of a train in compliance with the rules of the network on which the vehicle is operated. The rear end signal must only be exhibited on the rear of the last vehicle of the train.
- Where a freight wagon is used as the front-end of a train, the rail transport undertaking operating the train must provide the means of indicating the front-end of a train in compliance with the rules of the network on which the train is operated.
- The rail transport undertaking operating the train must make sure that freight vehicles are safely and securely loaded and remain so throughout the journey.
- Train composition shall be the responsibility of the rail transport undertaking. Rules and procedures shall be defined which must be

(<sup>62</sup>)

*(4.2.1.2.) The railway undertaking operating the train must supply the driver with all the necessary information and documentation required to carry out his duties.*

*This information must take into account the necessary elements for operation in normal, degraded and emergency situations for the routes to be worked over and the rolling stock used on those routes.*

*(4.2.1.3.) The railway undertaking must provide all members of his staff (whether on train or otherwise) who undertake safety-critical tasks involving a direct interface with the staff, equipment or systems of the infrastructure manager with the rules, procedures, rolling stock and route specific information it deems appropriate to such tasks. Such information shall be applicable in both normal and degraded operation.*

*(4.2.2.1.3.) The railway undertaking must provide the required means of indicating the rear of a train. The rear end signal must only be exhibited on the rear of the last vehicle of the train. It must be displayed as shown below.*

*(4.2.2.1.2.) The railway undertaking must ensure that an approaching train is clearly visible and recognisable as such, by the presence and layout of its lit white front-end lights.*

*The forward facing front-end of the leading vehicle of a train must be fitted with three lights in an isosceles triangle, as shown below.*

*(4.2.2.4.1.) The railway undertaking must make sure that freight vehicles are safely and securely loaded and remain so throughout the journey.*

*(4.2.2.5.) The railway undertaking must define the rules and procedures to be followed by his staff so as to ensure that the train is in*

<sup>62</sup> The corresponding EU requirements are set out in Decision 2012/757/EC (OPE TSI) as last amended by Commission Regulation (EU) 2015/995 of 8<sup>th</sup> of June 2015

<sup>63</sup> "required means" are lamps and/or plates as specified in Appendix E

 <b>OTIF</b>	<b>ROLLING STOCK FREIGHT WAGONS</b>		<b>UTP WAG</b> Page 107 of 151
Status: <b>PROPOSAL</b>		TECH-20005 Annex	Original: EN Date: 17.06.2020

followed by the staff so as to ensure that the train is in compliance with the allocated path.

- Train composition requirements must take into account the following elements:

a) the vehicles

— all vehicles in the train must be in compliance with all the requirements applicable on the routes over which the train will run;

— all vehicles on the train must be fit to run at the maximum speed at which the train is scheduled to run;

— all vehicles on the train must be currently within their specified maintenance interval and remain so for the duration (in terms of both time and distance) of the journey being undertaken;

b) the train

— the combination of vehicles forming a train must comply with the technical constraints of the route concerned and be within the maximum length permissible for forwarding and receiving terminals.

— the railway undertaking is responsible for ensuring that the train is technically fit for the journey to be undertaken and remains so throughout the journey

c) the weight and axle load

— the weight of the train must be within the maximum permissible for the section of route, the strength of the couplings, the traction power and other relevant characteristics of the train. Axle load limitations must be respected.

d) the maximum speed of the train

— the maximum speed at which the train can run must take into account any restrictions on the route(s) concerned, braking performance, axle load and vehicle type.

e) the kinematic envelope

— the kinematic gauge of each vehicle (inclusive of any load) in the train must be within the maximum permissible for the section of route.

Additional constraints may be required or imposed due to the type of braking regime

*compliance with the allocated path.*

*Train composition requirements must take into account the following elements:*

*(a) the vehicles*

*— all vehicles in the train must be in compliance with all the requirements applicable on the routes over which the train will run;*

*— all vehicles on the train must be fit to run at the maximum speed at which the train is scheduled to run;*

*(b) all vehicles on the train must be currently within their specified maintenance interval and will remain so for the duration (in terms of both time and distance) of the journey being undertaken;*

*(c) the train*

*— the combination of vehicles forming a train must comply with the technical constraints of the route concerned and be within the maximum length permissible for forwarding and receiving terminals.*

*(d) the railway undertaking is responsible for ensuring that the train is technically fit for the journey to be undertaken and remains so throughout the journey*

*(e) the weight and axle load*

*(f) the weight of the train must be within the maximum permissible for the section of route, the strength of the couplings, the traction power and other relevant characteristics of the train. Axle load limitations must be respected.*

*(g) the maximum speed of the train*

*— the maximum speed at which the train can run must take into account any restrictions on the route(s) concerned, braking performance, axle load and vehicle type.*

*(h) the kinematic envelope*

*(i) the kinematic gauge of each vehicle (inclusive of any load) in the train must be within the maximum permissible for the section of route.*

*Additional constraints may be required or imposed due to the type of braking regime or*

 <b>OTIF</b>	<b>ROLLING STOCK FREIGHT WAGONS</b>		<b>UTP WAG</b> Page 108 of 151	
Status: <b>PROPOSAL</b>		TECH-20005 Annex	Original: EN	Date: 17.06.2020

or traction type on a particular train

- All vehicles in a train must be connected to the continuous automatic braking system. The first and last vehicles (including any traction units) in any train must have the automatic brake operative<sup>64</sup>. The rail transport undertaking operating the train must ensure that the train meets the required braking performance.

*traction type on a particular train*

*(4.2.2.6.1.) All vehicles in a train must be connected to the continuous automatic braking system as defined in the TSI Rolling Stock*

*The first and last vehicles (including any traction units) in any train must have the automatic brake operative.*

*(4.2.2.6.2.) Braking performance and maximum speed allowed*

*(1) The infrastructure manager shall provide the railway undertaking with all relevant line characteristics for each route:*

- *signalling distances (warning, stopping) containing their inherent safety margins,*
- *gradients,*
- *maximum permitted speeds, and*
- *conditions of use of braking systems possibly affecting the infrastructure such as magnetic, regenerative and eddy-current brake.*

*(2) Additionally, the infrastructure manager may provide the following information:*

*(i) for trains able to run at a maximum speed higher than 200 km/h, deceleration profile and equivalent response time on level track;*

*(ii) for trainsets or for fixed train compositions, unable to run at a maximum speed higher than 200 km/h, deceleration (as above in (i)) or brake weight percentage;*

*(iii) for other trains (variable compositions of trains unable to run at a maximum speed higher than 200 km/h): brake weight percentage.*

*If the infrastructure manager provides the abovementioned information, it shall be made available to all RUs who intend to operate trains on its network. The braking tables already in use and accepted for the existing lines at the date of entry into force of the present regulation shall also be made available.*

*(3) The railway undertaking shall, in the planning stage, determine the braking capability of the train and corresponding maximum speed taking into account:*

- *the relevant line characteristics as expressed in point (1) above or, if available, the*

<sup>64</sup> In operation / in working order / functioning.

 <b>OTIF</b>	<b>ROLLING STOCK FREIGHT WAGONS</b>		<b>UTP WAG</b> Page 109 of 151
Status: <b>PROPOSAL</b>		TECH-20005 Annex	Original: EN Date: 17.06.2020

- Processes shall be defined, which must be followed by the rail transport undertaking to ensure that all safety-related on-train equipment is in a fully functional state and that the train is safe to run. In case of modification to the characteristics of the train affecting the ability to accommodate the train in its allocated path, procedures for running in degraded mode shall be defined.
- The rail transport undertaking shall inform the infrastructure manager of any change which affects the performance of the train, or which may affect the ability to accommodate the train in its allocated path.
- Checks shall be defined which must be followed by the rail transport undertaking to ensure that any departure is undertaken safely (e.g. doors, load, brakes).

*information provided by the infrastructure manager in accordance to point (2) above. If the infrastructure manager has provided the information of point (2), the railway undertaking has to express the braking capability by using the same information, and*

- *the rolling-stock-related margins derived from reliability and availability of the braking system. EN L 165/24 Official Journal of the European Union 30.6.2015*

*Furthermore, the railway undertaking shall ensure that during operation each train achieves at least the necessary braking performance. The railway undertaking shall set up and implement corresponding rules and shall manage them within its safety management system.*

*In particular the railway undertaking has to set up rules to be used if a train does not reach the necessary braking performance during operation. In this case, the railway undertaking must immediately inform the infrastructure manager. The infrastructure manager may take appropriate measures to reduce the impact on the overall traffic on its network.*

*(4.2.2.7.1.) The railway undertaking must define the process to ensure that all safety-related on-train equipment is in a fully functional state and that the train is safe to run.*

*The railway undertaking must inform the infrastructure manager of any modification to the characteristics of the train affecting its performance or any modification that might affect the ability to accommodate the train in its allocated path.*

*The infrastructure manager and the railway undertaking must define and keep up to date conditions and procedures for train running in degraded mode.*

*(4.2.3.3.1.) The railway undertaking must define the checks and tests to ensure that any departure is undertaken safely (e.g. doors, load, brakes).*





**Appendix J: Attachment device for rear-end signal (point 4.2.6.3)**

Not used.

*This appendix is a transcription of section 1 of the ERA technical document ERA/TD/2012-04/INT version 1.3 of 2 December 2014 published on the ERA website and referred to in the WAG TSI. It appears in full width in order that the drawings remain legible.*

The dimensions and clearance of the attachment devices shall be as described in figure 1.

*Figure 1: Required dimensions and clearance for tail light brackets and access*

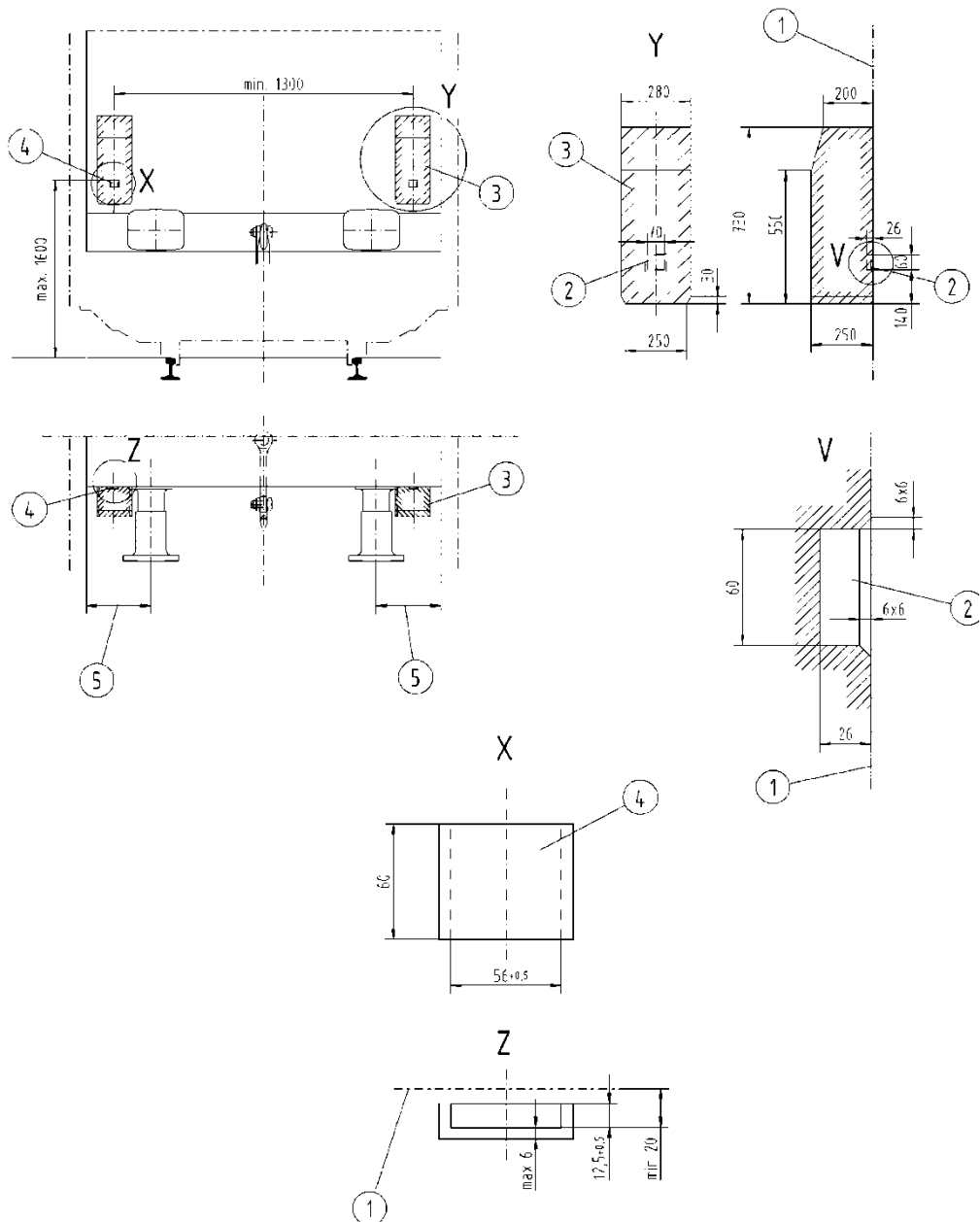

- Key: — 1 outside of wagon-end wall or bracket fixing plane
- 2 clearance for tail light bracket
- 3 clearance for tail light
- 4 tail light bracket
- 5 preferred place for tail light position

 <b>OTIF</b>	<b>ROLLING STOCK FREIGHT WAGONS</b>		<b>UTP WAG</b> Page 111 of 151
Status: <b>PROPOSAL</b>		TECH-20005 Annex	Original: EN Date: 17.06.2020

**Appendix K: Clearance for draw hooks (Appendix C, Section 1)**

Not used.

*This appendix is a transcription of section 2 of the ERA technical document ERA/TD/2012-04/INT version 1.3 of 2 December 2014 published on the ERA website and referred to in the WAG TSI. It appears in full width in order that the drawings remain legible.*

The clearance for the draw hook shall be in accordance with figure 2.

*Figure 2: Required clearance above draw hook*

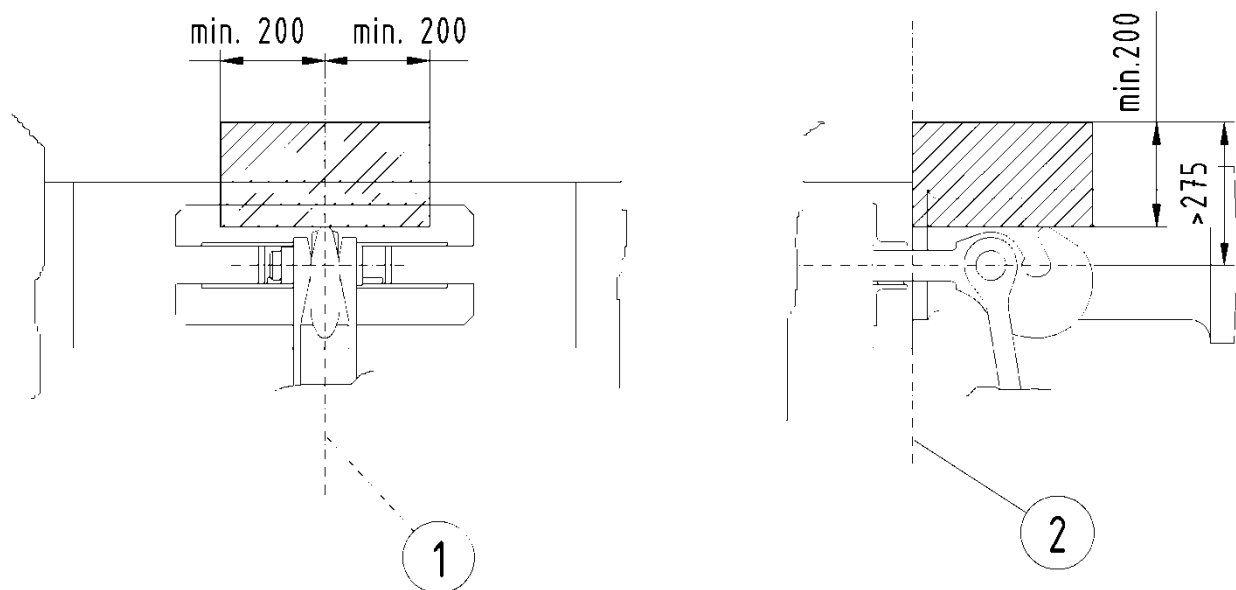

Key: 1 — centre line of wagon  
2 — buffer fixing plane



**Appendix L: Space for shunting staff operation (Appendix C, Section 1)**

Not used.

*This appendix is a transcription of section 3 of the ERA technical document ERA/TD/2012-04/INT version 1.3 of 2 December 2014 published on the ERA website and as referred to in the WAG TSI. It appears in full width in order that the drawings remain legible.*

The space for shunting staff operation shall be in accordance with figure 3. Flexible connecting cables and flexible hoses may be inside this space. With the exception of the shunter handrails (see Appendix C, section 2 of this UTP), there shall be no devices under the buffers that hinder access to the space.

*Figure 3: Required space for shunter during coupling and uncoupling*

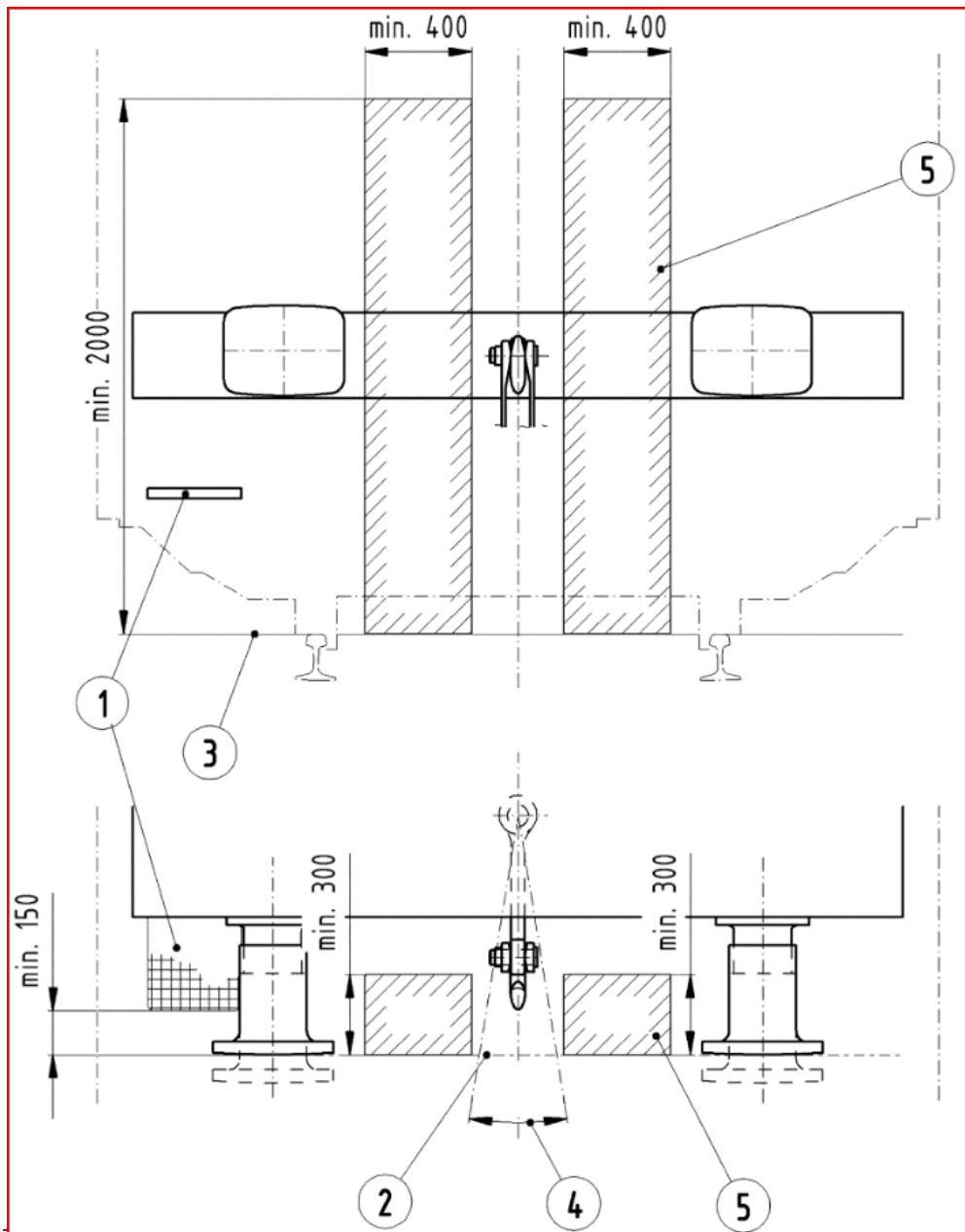

- Key: ———
- 1 end step
  - 2 contact plane of fully compressed buffers
  - 3 top of rail
  - 4 lateral movement of coupling at coupled units
  - 5 space for shunter

 <b>OTIF</b>	<b>ROLLING STOCK FREIGHT WAGONS</b>		<b>UTP WAG</b> Page 113 of 151
Status: <b>PROPOSAL</b>		TECH-20005 Annex	Original: EN Date: 17.06.2020

## **Appendix M: Footsteps and handrails (Appendix C, Section 2)**

Not used.

*This appendix is a transcription of section 4 of the ERA technical document ERA/TD/2012-04/INT version 1.3 of 2 December 2014 published on the ERA website and as referred to in the WAG TSI. It appears in full width in order that the drawings remain legible.*

### **~~4.1 Minimum requirements for handrails~~**

~~All handrails~~

- ~~• shall be of round steel bar or steel pipe with a min. diameter of 20 mm and a max. diameter of 35 mm.~~
- ~~• shall withstand the loads, which are applied by staff,~~
- ~~• shall respect a clearance to the nearest obstructions of at least 120 mm.~~

### **~~4.2 Minimum requirements for footsteps~~**

~~All footsteps~~

- ~~• shall have sufficient space above and around in order to enable the staff to use them safely.~~
- ~~• shall be slip resistant~~
- ~~• shall withstand the loads, which are applied by the staff.~~

~~The minimum requirements concerning slip resistance deemed to be complied with if the grating in accordance with figure 4 is used or if the following requirements are fulfilled:~~

#### ~~a) Skid resistance~~

~~The average value of the friction coefficient measured in three directions (lengthwise, breadthwise and diagonally) shall reach the following minimum values:~~

- ~~a) in dry condition = 0,65~~
- ~~b) in wet condition (water) = 0,65~~
- ~~e) in oiled condition = 0,30~~

~~Friction coefficient values shall be ascertained by means of a 100 mm x 100 mm movable plate, on which a rubber pad with 80 shore hardness shall be glued. This plate shall be loaded with a weight of 75 kg. For the measurements carried out with water and oil, the grating shall be fully immersed.~~

#### ~~b) Grating structure~~

~~To ensure that the gratings are sufficiently well adapted to winter conditions, a ratio of at least 50 % of "void" area to total area shall be observed (the "void" area is the free space afforded by the grating apertures in the vertical direction). Only apertures with a minimum area of 400 mm<sup>2</sup> shall be taken into account to determine this ratio.~~

~~With regard to the ability to withstand the load the following shall be fulfilled:~~

~~Metal gratings shall withstand, without residual deformation, a horizontal compression force of at least 4 kN, exerted parallel and at right angles to the edge of the step board, and of at least 8 kN exerted diagonally in relation to the edge of the step board. Elastic deformations shall not exceed 10 mm.~~

### **~~4.3 Shunter's stand~~**

~~There shall be at least one shunter's stand consisting of one shunter's step and one handrail at each end of the unit to enable shunting staff to travel on board the unit during shunting operations. The handrails and footsteps shall be in accordance with section 4.1 and 4.2 with the following additions and exceptions:~~

~~handrail~~

 <b>OTIF</b>	<b>ROLLING STOCK FREIGHT WAGONS</b>			<b>UTP WAG</b> Page 114 of 151
Status: <b>PROPOSAL</b>		TECH-20005 Annex	Original: EN	Date: 17.06.2020

- ~~• A clearance of 100 mm between the handrails and the nearest obstruction is permitted.~~
  - ~~• The handrail shall be made from steel pipe with a diameter of 30 +5/0 mm, with a minimum wall thickness of 2 mm and a minimum clearance of 230 mm.~~
- footstep
- ~~• The shunter's steps shall be at least 150 mm from a vertical plane at the end of the fully compressed buffers (see figure 3).~~
  - ~~• The shunter's steps and handrails shall be placed as set out in figure 5.~~
  - ~~• The free space above the shunter's steps shall be as set out in figure 6 with the exception concerning the handrail specified in figure 5.~~
  - ~~• The dimensions of the shunter's step shall be in accordance with figure 4. For specific operation the size of the footstep can be reduced from 350 mm width and 350 mm length to 270 mm width and 225 mm length.~~
  - ~~• The shunter's steps shall be fixed by means, which allow removable mounting.~~
  - ~~• The material for the shunter's steps support shall be S355J2C + N in accordance with EN 10025 2.~~
  - ~~• Cold forming for shunter's steps support is not allowed.~~
  - ~~• The grating shall be according to figure 4.~~

~~The shunter's stand is not required where the end of the unit is equipped with a gangway in accordance with section 4.4.~~

~~Furthermore, there shall be a handrail under each buffer (shunter's handrail) of the unit which shall be as specified in figures 7 and 8.~~

 <b>OTIF</b>	<b>ROLLING STOCK FREIGHT WAGONS</b>		<b>UTP WAG</b> Page 115 of 151
Status: <b>PROPOSAL</b>		TECH-20005 Annex	Original: EN Date: 17.06.2020

*Figure 4: Shunter's step*

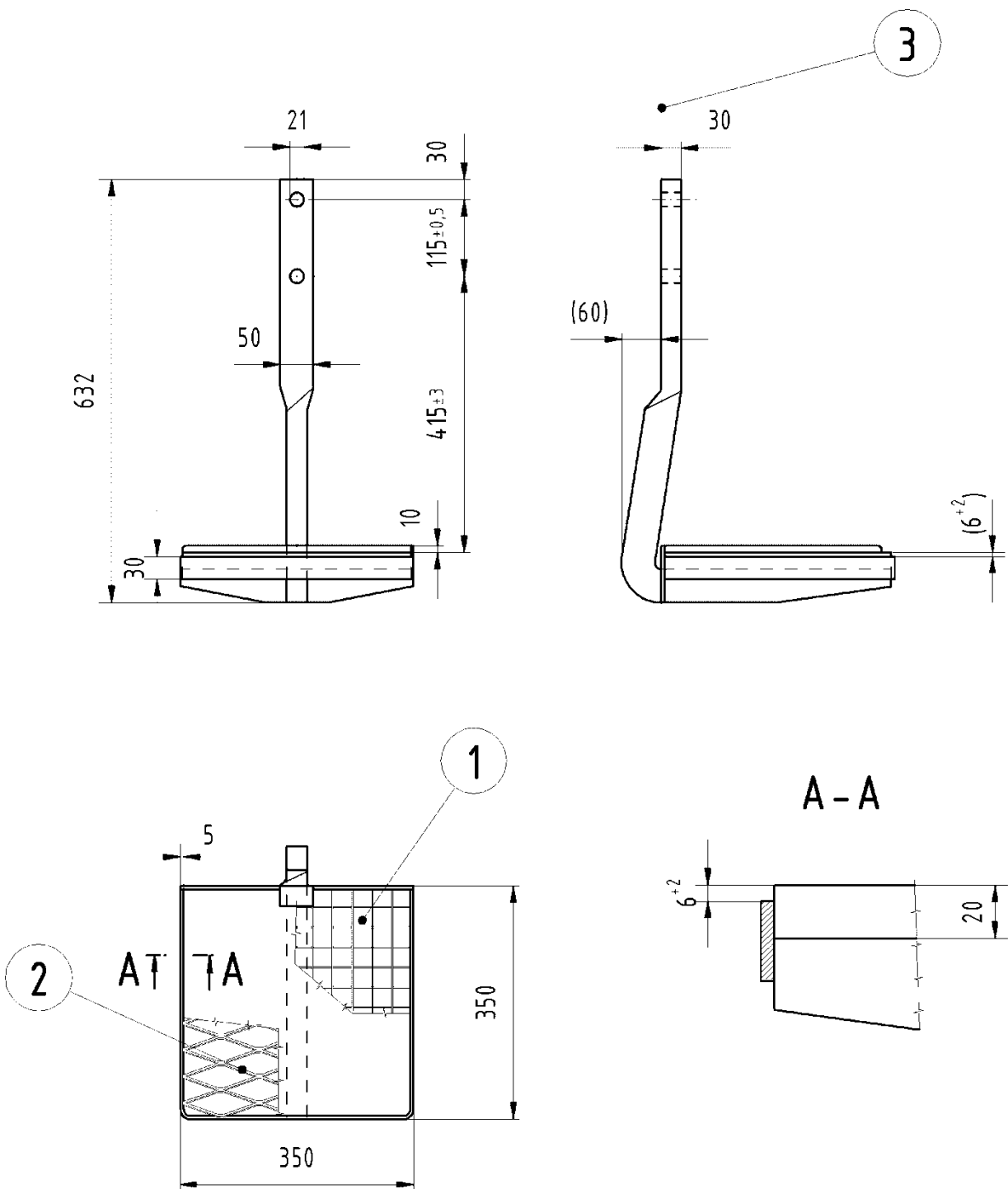

Key: — 1 grating from welded metal  
— 2 grating from expanded metal  
— 3 buffer fixing plane



Figure 5: Shunter's stand

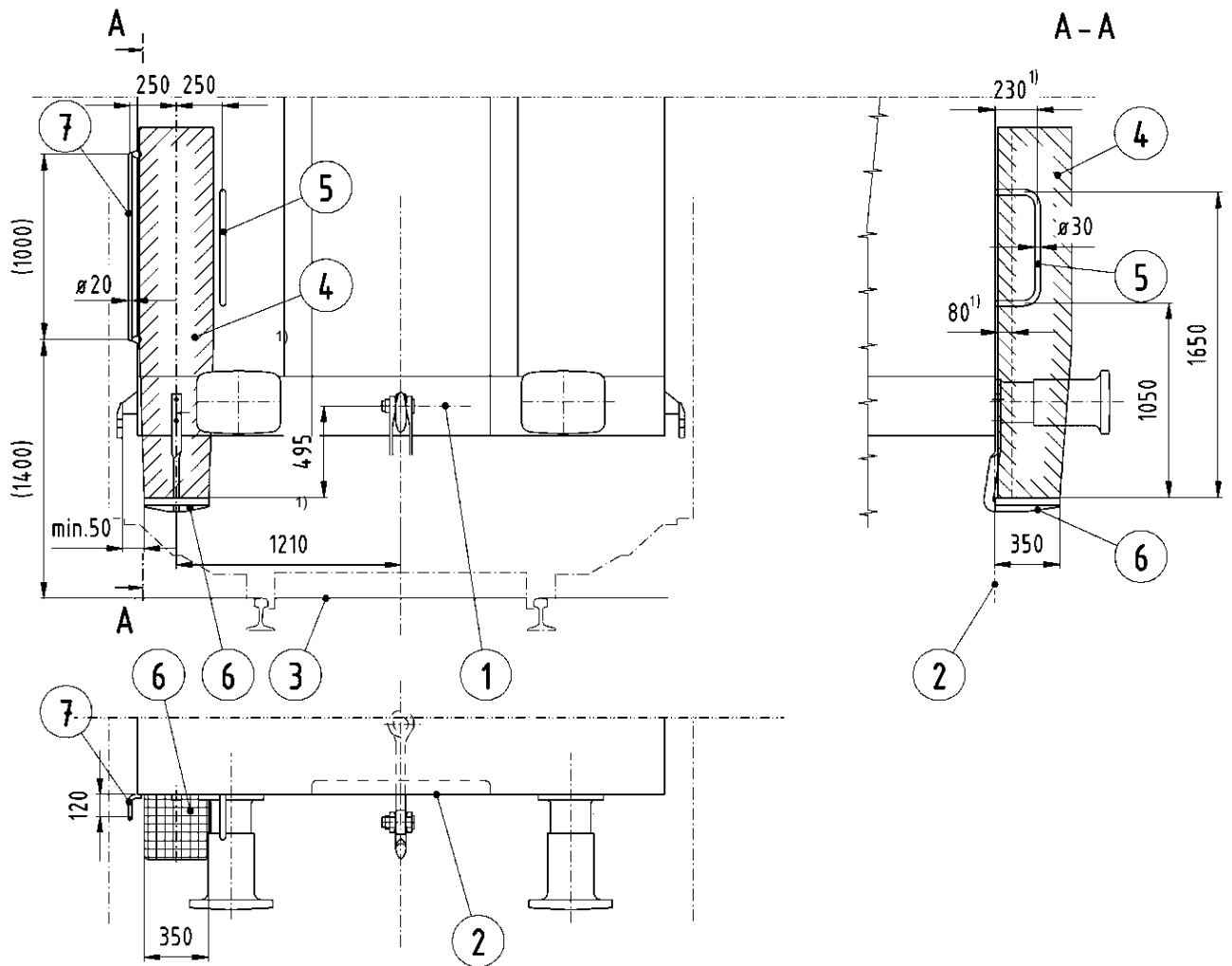

- Key: — 1 AC centre line  
 2 buffer fixing plane  
 3 top of rail  
 4 reserved space as specified in Figure 5  
 5 handrail  
 6 step  
 7 2<sup>nd</sup> handrail corner upright (only at wagon s with end walls)

1) In exceptional cases (e.g. particular gauges), and in order to comply with the reserved space stated in figure 6, as long as the kinematic gauge is respected, the shunter's stand can be adjusted in horizontal direction. Only if this method is not successful, a vertical adjustment of the shunter's stand could be accepted, but not more as allowed by the kinematic gauge. The vertical position shall not be less than 480 mm from coupling centre line.

 <b>OTIF</b>	<b>ROLLING STOCK FREIGHT WAGONS</b>		<b>UTP WAG</b> Page 117 of 151
Status: <b>PROPOSAL</b>		TECH-20005 Annex	Original: EN Date: 17.06.2020

*Figure 6: Required space above left footstep*

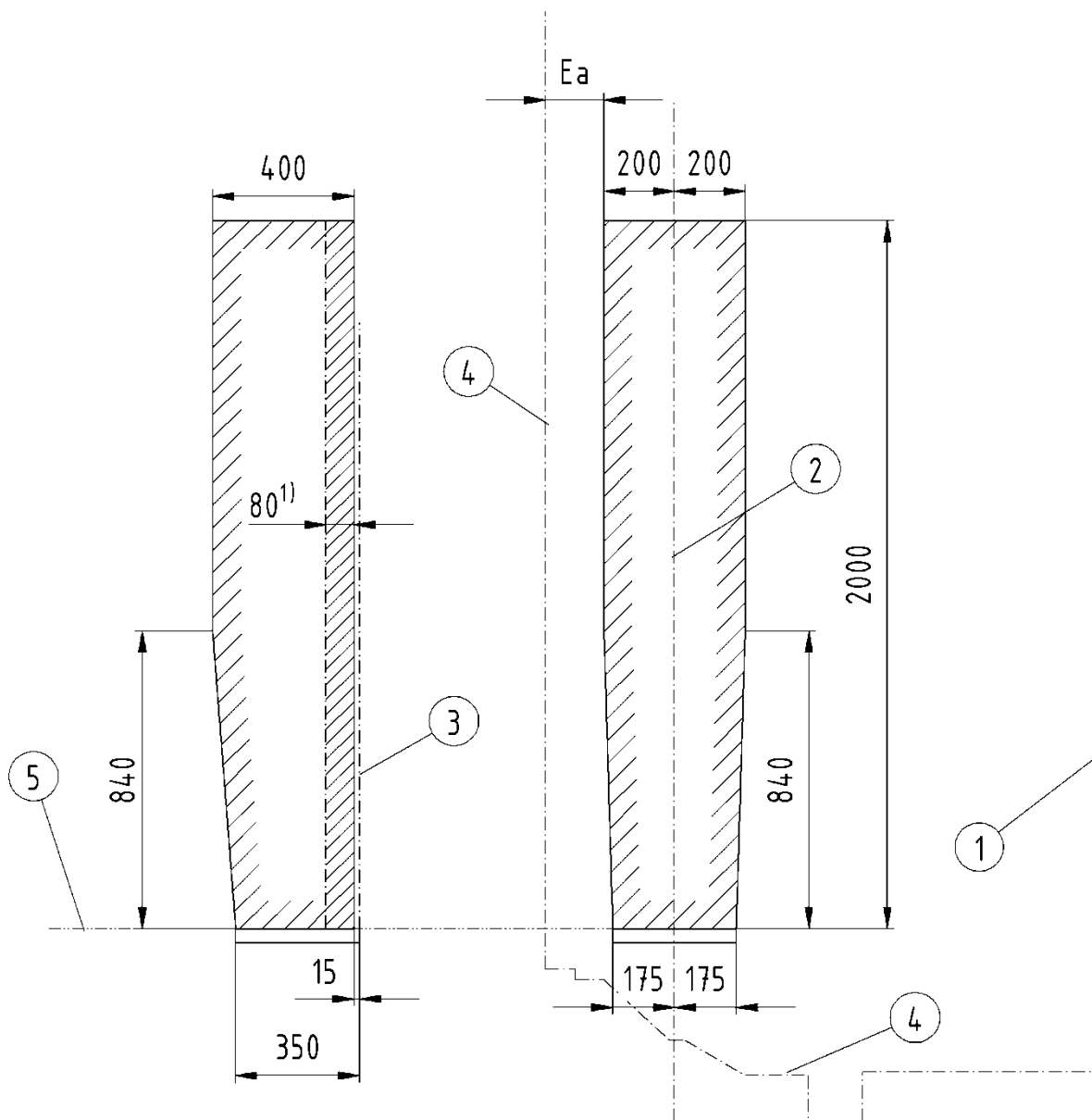

Key: — 1 centre line of wagon  
— 2 centre line of left end-step  
— 3 buffer fixing plane  
— 4 kinematic-gauge  
— 5 step level

1) In the event of design problems, component parts such as the closing and locking devices of sliding walls may exceptionally infringe this space. These components must nonetheless be placed parallel to the end wall and have no projecting parts liable to cause injury.



 <b>OTIF</b>	<b>ROLLING STOCK FREIGHT WAGONS</b>		<b>UTP WAG</b> Page 118 of 151
Status: <b>PROPOSAL</b>		TECH-20005 Annex	Original: EN Date: 17.06.2020

*Figure 7: Positions of shunter handrails*

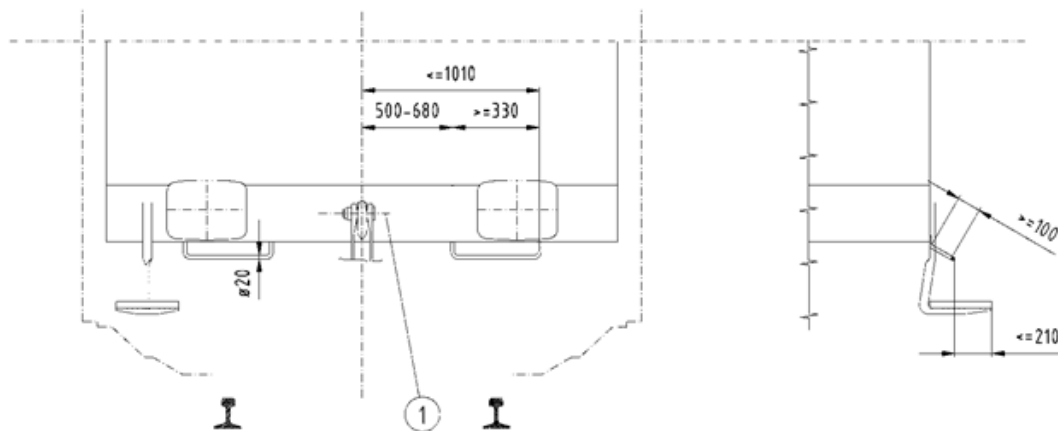

Key: — 1 AC centre line

*Figure 8: Position of shunter handrails by using automatic coupler*

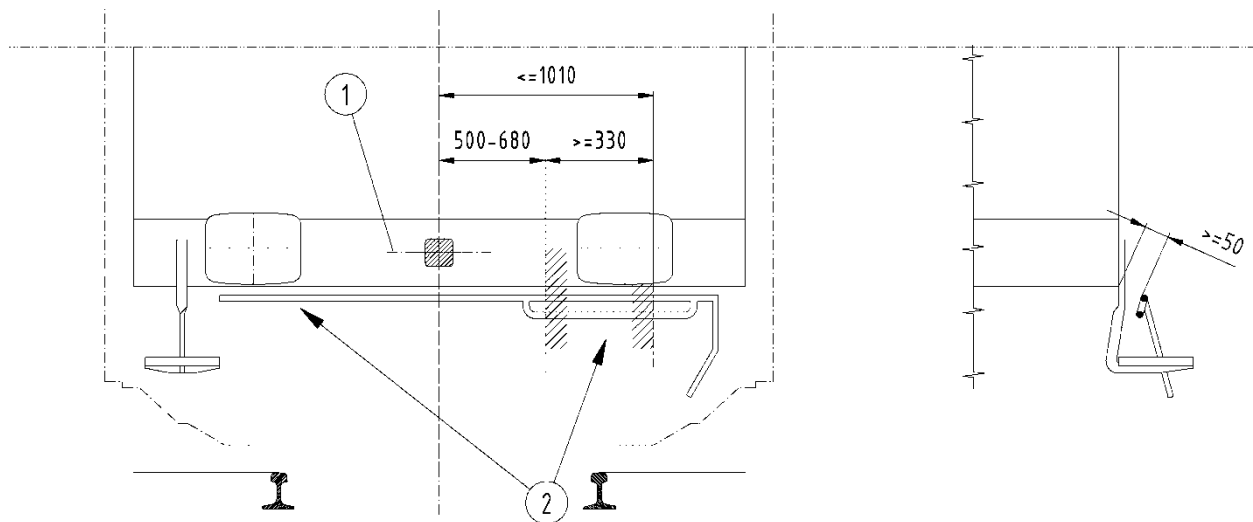

Key: — 1 AC centre line

2 area which may be used by the shunter in the case of a wagon fitted with the automatic coupler

 <b>OTIF</b>	<b>ROLLING STOCK FREIGHT WAGONS</b>			<b>UTP WAG</b> Page 119 of 151
Status: <b>PROPOSAL</b>		TECH-20005 Annex	Original: EN	Date: 17.06.2020

#### **4.4 Gangways**

The design and position of the gangways shall be as specified in figure 9.

To facilitate climbing onto the gangway, the following items shall be fitted on both sides of the unit:

- Two footsteps (160 x 430 mm) long. The lower footstep shall be set at a height of 425 mm below the horizontal plane running through the centreline of the coupling.
- Vertical handrail, fitted to each corner upright.
- Vertical part of the railing shaped like a handrail.

It shall be possible for the shunting staff to remain on the upper footsteps while the vehicle is moving. To allow this, clearance shall be maintained over the upper footsteps as specified in figure 10.

The surface of the steps and of the gangway shall be designed with a non-slip surface.

The gangway shall be equipped with a gangway handrail providing a secure hand hold for the shunting staff, even while the vehicle is moving. An intermediate rail at knee height shall be provided to prevent the shunting staff from falling off. The ends of these intermediate rails shall be fashioned in such a way as to form a guide to the footsteps.

For traffic to UK, as long as the kinematic gauge is respected, the lower footsteps can be adjusted in the horizontal direction. Only if this method is not successful, a vertical adjustment of the lower steps could be accepted, but not more than permitted by the kinematic gauge.



Figure 9: Example for gangway

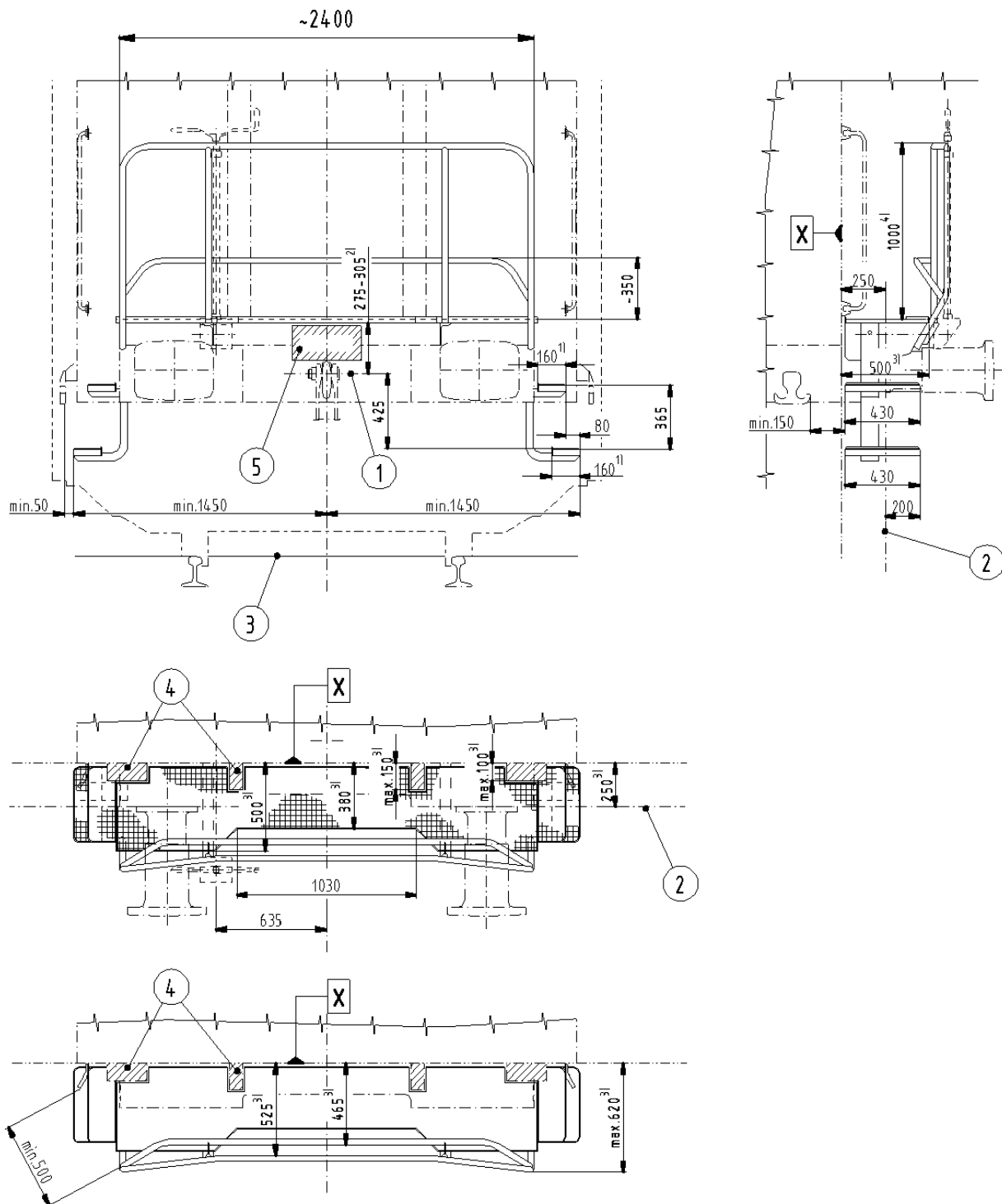

Key

- 1-coupling centre line
- 2-buffer fixing plane
- 3-top of rail
- 4 space for exceptionally infringement by components, closing and locking devices or superstructure
- 5-clearance for draw hook

- 1) step width
- 2) min. dimension for clearance of draw hook – see chapter 2, figure 2
- 3) distances from plane "X"
- 4) the height of the guard rail of 1000mm may be increased for operational reasons

 <b>OTIF</b>	<b>ROLLING STOCK FREIGHT WAGONS</b>		<b>UTP WAG</b> Page 121 of 151
Status: <b>PROPOSAL</b>		TECH-20005 Annex	Original: EN Date: 17.06.2020

*Figure 10: Required space above the top access step of the platforms and gangways*

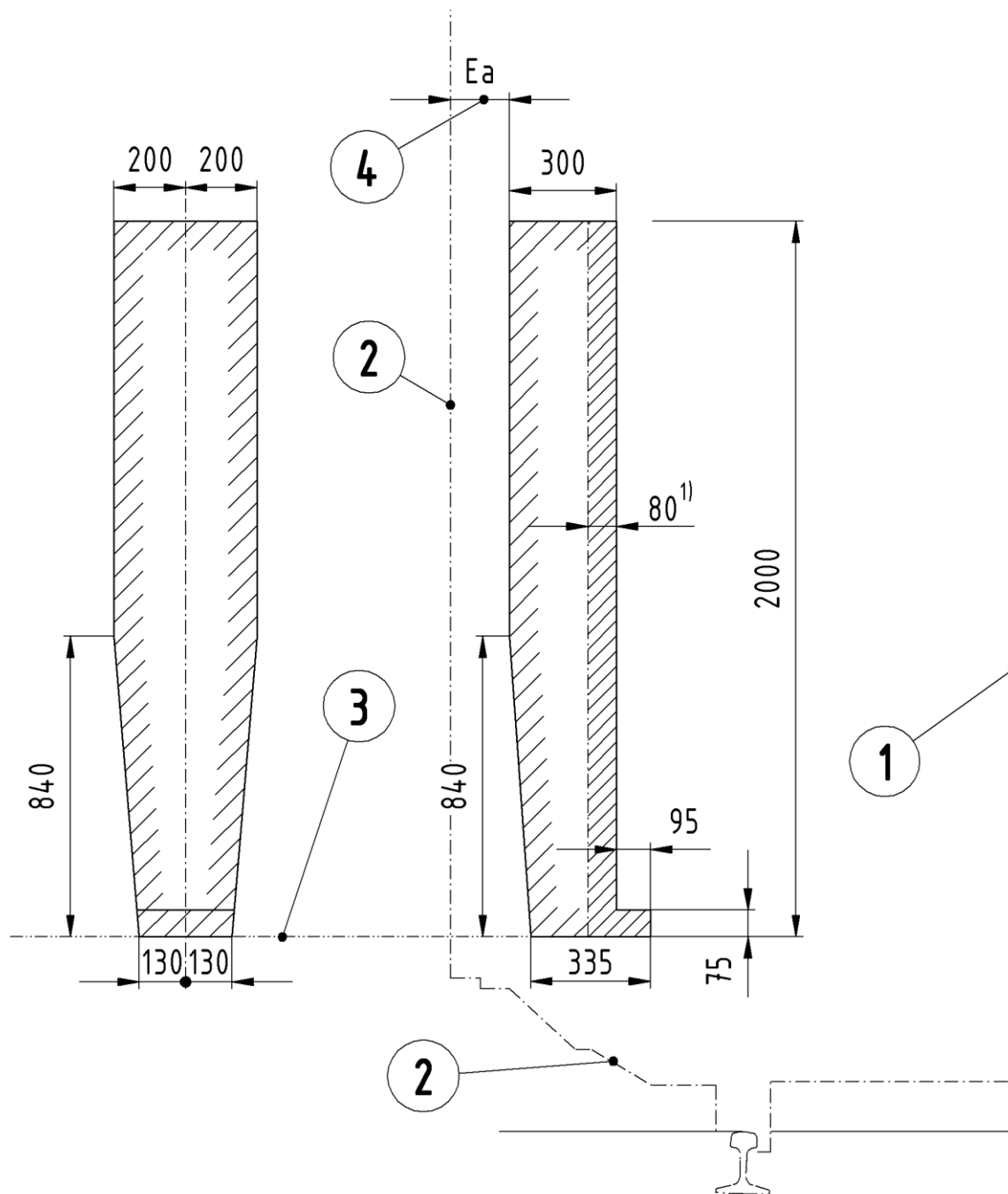

**Key**

- 1 centre line of wagon
- 2 kinematic gauge
- 3 step level
- 4 Transverse reduction according to EN 15273-2

1) In the event of design problems, component parts such as the closing and locking devices of sliding walls may exceptionally infringe this space. These components shall nonetheless be placed parallel to the end wall and have no projecting parts liable to cause injury.

 <b>OTIF</b>	<b>ROLLING STOCK FREIGHT WAGONS</b>		<b>UTP WAG</b> Page 122 of 151
Status: <b>PROPOSAL</b>		TECH-20005 Annex	Original: EN Date: 17.06.2020

## **Appendix N: Specifications on slack adjusters**

Not used.

*This appendix is a transcription of the ERA technical document ERA/TD/2012-05/INT version 1.0 of 04.06.2012 published on the ERA website and as referred to in the WAG TSI:2013. It appears in full width in order to keep the drawings readable.*

### **1. — Functional specifications of slack adjusters**

The assembly of the slack adjuster shall be aimed to prevent any partial or full detachment of these components.

A device to automatically maintain the design clearance between the friction pair shall be provided.

A minimum of 15 mm clearance between the slack adjuster envelope and other components shall be provided.

Provision shall be made for the necessary free clearances for the slack adjuster extremities and connections to be maintained at all times.

For slack adjusters within a bogie, there is no special envelope. But, for all design conditions, the minimum clearance necessary between the slack adjuster and other components shall be ensured to prevent contact. Should a smaller clearance be required, the reasons why contact will not occur shall be demonstrated.

### **2. — Specifications for slack adjusters**

Slack adjusters are necessary to automatically maintain a nominally constant clearance between the friction pair (wheel and brake block or disc and brake pad) in order to maintain the braking characteristics and guarantee the braking performance.

The slack adjuster shall not absorb more than 2 kN of the brake application force. The performance characteristics of the slack adjuster shall not be varied by environmental conditions (vibrations, winter conditions, etc.).

There is no requirement for interchangeability of slack adjuster, but if they are to be interchangeable the space envelopes as set out in figure 1 and 2 apply (only the values in the table are necessary).

Interchangeable Slack adjusters which are placed within the underframe shall not exceed the space envelopes as set out in figure 1 and 2.



Figure 1: Space envelope for loads up to a maximum of 75 kN

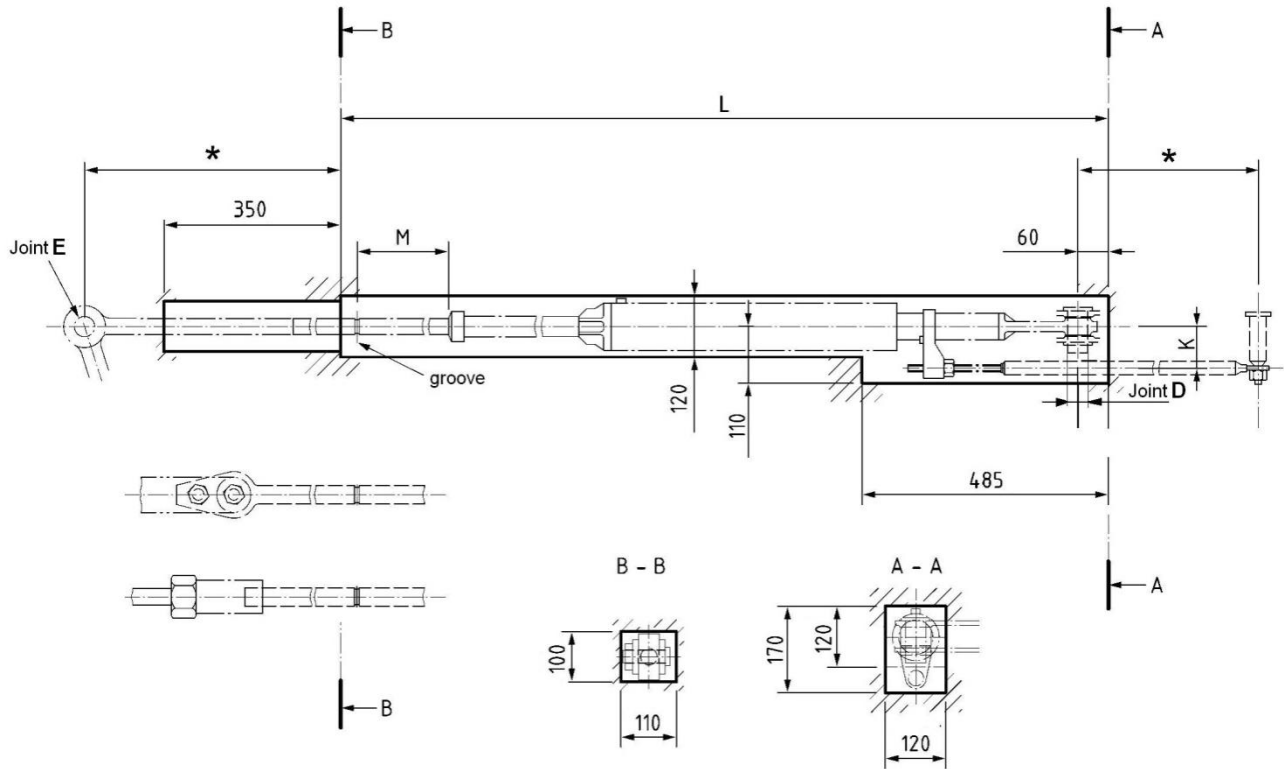

sequence	length	Attribute of the slack adjuster			
		length to adjust	load	reagent	distance
	L	M			K
1	2325	580	75kN	2kN	83**
2	1876	440			

\* adapted at the wagon

\*\* recommended for new engineering



Figure 2: Space envelope for loads greater than 75 kN

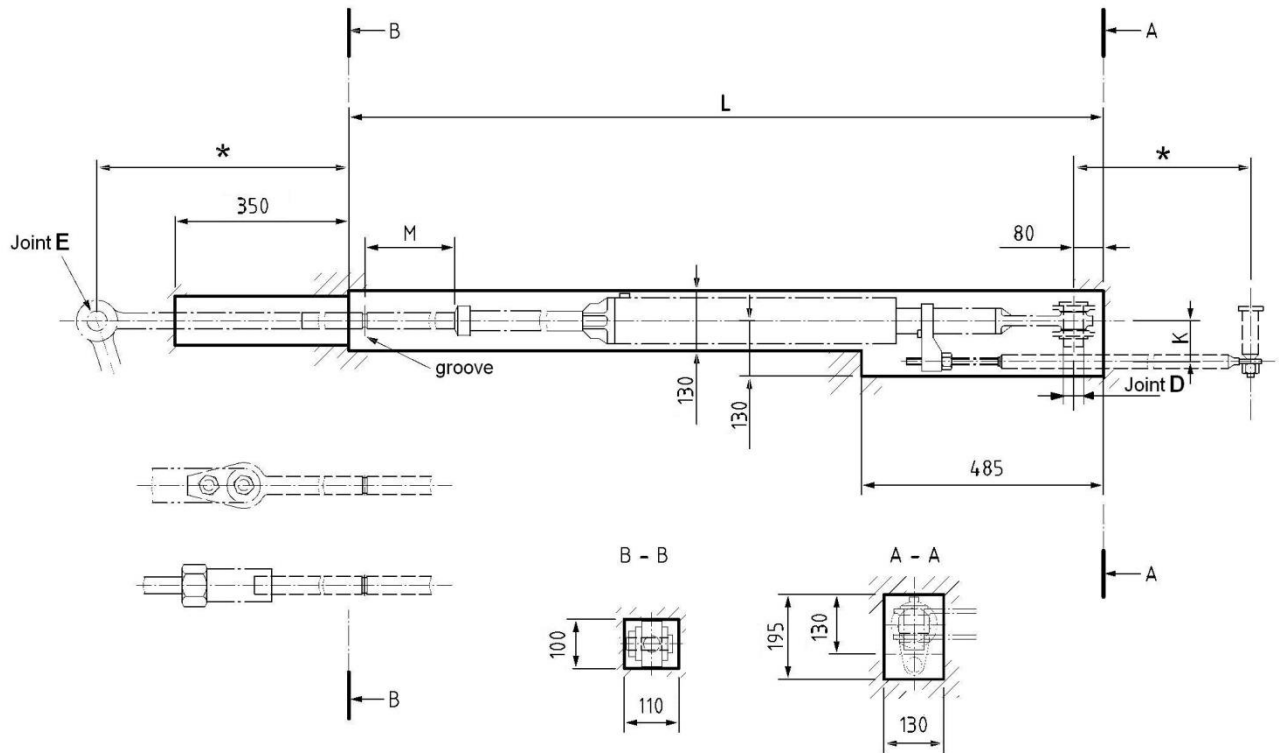

sequence	length	Attribute of the slack adjuster			
		length to adjust	load	reagent	distance
	<b>L</b>	<b>M</b>			<b>K</b>
1	2390	580	75kN	2kN	83**
2	1940	440			
3	1640	280			

\* adapted at the wagon

\*\* recommended for new engineering

### 3. Design assessment of slack adjusters

The design assessment of the slack adjuster shall be made by ensuring the mechanical strength is suitable for the load to be transmitted. Interchangeable slack adjusters are shown in chapter 2 with their permitted maximum loads. The assessment will also ensure that the friction pair distance can be maintained within sensible limits so that the friction pair do not touch each other without braking, the braking characteristics are maintained and the braking performance is guaranteed.

A life test shall be performed to demonstrate the suitability of the unit for service on railway vehicles and to verify the maintenance requirements for the operational design life. This shall be carried out at the maximum rated load cycling through the full range of adjustment.

### 4. Product assessment for slack adjusters

Every slack adjuster shall be tested. The features to be tested are:

- Maximum take up
- Maintenance of set clearance

 <b>OTIF</b>	<b>ROLLING STOCK FREIGHT WAGONS</b>			<b>UTP WAG</b> Page 125 of 151
Status: <b>PROPOSAL</b>		TECH-20005 Annex	Original: EN	Date: 17.06.2020

- ~~• Incremental take up~~
- ~~• Letting out when no clearance to obtain set clearance (double acting units only)~~
- ~~• Ability to reset to minimum length (contracting slack adjuster) or maximum length (extending slack adjuster)~~



 <b>OTIF</b>	<b>ROLLING STOCK FREIGHT WAGONS</b>			<b>UTP WAG</b> Page 126 of 151
Status: <b>PROPOSAL</b>		TECH-20005 Annex	Original: EN	Date: 17.06.2020

## **Appendix O: conformity assessment of friction elements for wheel tread brakes**

*This appendix is a transcription of the ERA technical document ERA/TD/2013-02/INT version 2.0 of 15.12.2014 published on the ERA website and as referred to in the WAG TSI. It appears in full width in order to keep the drawings and tables readable.*

### **1. INTRODUCTION**

The present document provides the necessary specifications to perform the assessment of conformity of friction elements for wheel tread brakes. It is referred to in point 6.1.2.5 and Appendix D of the technical specification for interoperability relating to the subsystem ‘rolling stock – freight wagons’ following its amendment related to ‘friction elements for wheel tread brakes’ (ready for adoption in 2015).

The present document is based on FprEN 16452: Railway applications - Braking - Brake blocks, dated March 2014.

### **2. TERMS AND DEFINITIONS**

For the purposes of this document the following terms and definitions apply.

Bg arrangement:	arrangement with one friction element per friction element holder
Bgu arrangement:	arrangement with two friction elements per friction element holder
1Bg:	unilateral configuration with one friction element per friction element holder
2Bg:	bilateral configuration with one friction element per friction element holder
1Bgu:	unilateral configuration with two friction elements per friction element holder
2Bgu:	bilateral configuration with two friction elements per friction element holder
friction element:	stator part of a tread brake adapted to generate a friction force when engaged with a wheel tread
friction element force:	force with which the friction element is made to come into contact with the wheel tread
friction element back plate:	element onto which the friction element is fixed, acting as the interface between the friction element and friction element holder
friction material:	consumable portion of the friction element that acts on the wheel tread in order to provide the specified brake performance
size of friction element:	product of height and width of the friction element without any correction for grooves
instantaneous friction coefficient:	value of friction coefficient at any one instant
mean friction coefficient:	value of instantaneous friction coefficient integrated over distance
dynamic friction coefficient:	coefficient of friction achieved by the friction material during relative movement between the friction material surface and wheel tread
static friction coefficient:	coefficient of friction achieved by the friction material at the point where relative movement between the friction material surface and wheel tread starts to take place

 <b>OTIF</b>	<b>ROLLING STOCK</b> <b>FREIGHT WAGONS</b>		<b>UTP WAG</b> Page 127 of 151
	Status: <b>PROPOSAL</b>		TECH-20005 Annex

parking brake: brake used to prevent a stationary train from moving under specified conditions, until intentionally released (also called ‘immobilization braking’)

wheel tread temperature: average temperature out of three values measured by three rubbing thermocouples spaced equally across the wheel tread

### 3. ABBREVIATIONS

$m$	[t]	Mass to be braked per wheel for design mass (including rotating mass) in conformity with EN 15663
$m_1$	[t]	Mass $m$ in working order
$m_2$	[t]	Mass $m$ under normal payload
$m_{IW}$	[t]	Mass $m$ in working order divided by the number of wheels
$F_B$	[kN]	Nominal brake application force per wheel
$F_{B1}$	[kN]	Total friction element application force per wheel for braked mass $m_1$
$F_{B2}$	[kN]	Total friction element application force per wheel for braked mass $m_2$
$F_b$	[kN]	Instantaneous application force per wheel
$F_{PB}$	[kN]	Parking brake application force
$v$	[km/h]	Theoretical initial speed at the brake application initiation
$v_m$	[km/h]	Maximum service speed
$\mu_a$	[-]	Instantaneous friction coefficient determined at every instance of the braking by the ratio between the total brake force $F_{tR}$ and the total application force $F_b$
$\mu_m$	[-]	Mean friction coefficient determined from reaching 95 % of the nominal application force $F_B$ of the instantaneous friction coefficient $\mu_a$ for the stopping distance $s_2$
$\mu_{dyn}$	[-]	Dynamic friction coefficient
$\mu_{stat}$	[-]	Static friction coefficient
$\Theta_0$	[°C]	Mean initial temperature of the wheel tread at the beginning of the brake application
$s_1$	[m]	Stopping distance from beginning of the brake application to rest
$s_2$	[m]	Stopping distance from the moment on when $F_b = 0.95 F_B$ to rest
$D$	[mm]	Diameter of wheel
$P$	[-]	Brake type – P = passenger

### 4. DYNAMIC FRICTION COEFFICIENT

#### 4.1 Test program

The dynamometer test program for friction elements for wheel tread brakes to determine the dynamic friction coefficient  $\mu_{dyn}$  is set out in table 1. The corresponding terms, definitions and abbreviations are explained in sections 2 and 3.

 <b>OTIF</b>	<b>ROLLING STOCK</b> <b>FREIGHT WAGONS</b>		<b>UTP WAG</b> Page 128 of 151
	Status: <b>PROPOSAL</b>	TECH-20005 Annex	Original: EN

**Table 1:** Dynamometer test program to determine the dynamic friction coefficient

Friction element arrangement			To be defined by the applicant					
Wheel type			In conformity with EN 13979-1					
Wheel diameter			$\varnothing X \pm 5$ mm last machining size before wheel is fully worn in accordance with EN 13979-1					
Water flow rate			X l/h (without specific requirements 14 l/h should be used)					
No. of brake application			Initial speed	Total $F_B$ per wheel	Initial temp.	Mass to brake per wheel	Weighing after	Remarks
			$v$	$F_B$	$\theta_0$	$m$		
			[km/h]	[kN]	[°C]	[t]	No.	
1.1 - 1.X			$3/4 v_m$	$2/3 F_{B2}$	20-100	$m_2$	1.X	Brake applications to rest under dry conditions to allow bedding of the friction elements up to at least 85 % of the friction element surface
1	3	5	$3/4 v_m$	$F_{B2}$	50-60	$m_2$		Brake applications to rest under dry conditions, after a period of cooling
2	4	6	$v_m$					
7 to 26			$3/4 v_m$	$2/3 F_{B1}$	20-100	$m_1$		Conditioning stops
27	39		$3/4 v_m$	$2/3 F_{B1}$	50-60	$m_1$		Brake applications to rest under dry conditions, after a period of cooling
28	40		$1/4 v_m$					
29	41		$v_m$					
30	42		$1/2 v_m$					
31	43		$3/4 v_m$	$1/3 F_{B1}$	50-60	$m_1$		Brake applications to rest under dry conditions, after a period of cooling
32	44		$1/4 v_m$					
33	45		$v_m$					
34	46		$1/2 v_m$					
35	47		$3/4 v_m$	$F_{B1}$	50-60	$m_1$		Brake applications to rest under dry conditions, after a period of cooling
36	48		$1/4 v_m$					
37	49		$v_m$					
38	50		$1/2 v_m$					

 <b>OTIF</b>	<b>ROLLING STOCK</b> <b>FREIGHT WAGONS</b>		<b>UTP WAG</b> Page 129 of 151	
	Status: <b>PROPOSAL</b>		TECH-20005 Annex	Original: EN

**Table 1** (continued)

No. of brake application			Initial speed	Total $F_B$ per wheel	Initial temp.	Mass to brake per wheel	Weighing after	Remarks
			$v$	$F_B$	$\theta_0$	$m$		
			[km/h]	[kN]	[°C]	[t]	No.	
51			$3/4 v_m$	-	-	-		10 kW drag brake application for a period of 15 min in dry condition done immediately after brake n° 50 without interruption. This is to evenly distribute the residual stress within the wheel
52	64	76	$3/4 v_m$	$2/3 F_{B1}$	20-30	$m_1$		Brake applications to rest under wet conditions, after a period of cooling
53	65	77	$1/4 v_m$					
54	66	78	$v_m$					
55	67	79	$1/2 v_m$					
56	68	80	$3/4 v_m$	$1/3 F_{B1}$	20-30	$m_1$		Brake applications to rest under wet conditions, after a period of cooling
57	69	81	$1/4 v_m$					
58	70	82	$v_m$					
59	71	83	$1/2 v_m$					
60	72	84	$3/4 v_m$	$F_{B1}$	20-30	$m_1$		Brake applications to rest under wet conditions, after a period of cooling
61	73	85	$1/4 v_m$					
62	74	86	$v_m$					
63	75	87	$1/2 v_m$					
88	92		$3/4 v_m$	$F_{B2}$	20-30	$m_2$		Brake applications to rest under wet conditions, after a period of cooling
89	93		$1/4 v_m$					
90	94		$v_m$					
91	95		$1/2 v_m$					
96			$3/4 v_m$	-	-	-	96	10 kW drag brake application for a period of 15 min in dry condition done immediately after brake n° 95 without interruption to dry the friction element
97	109		$3/4 v_m$	$2/3 F_{B2}$	50-60	$m_2$		Brake applications to rest under dry conditions, after a period of cooling
98	110		$1/4 v_m$					
99	111		$v_m$					
100	112		$1/2 v_m$					
101	113		$3/4 v_m$	$1/3 F_{B2}$	50-60	$m_2$		Brake applications to rest under dry conditions, after a period of cooling
102	114		$1/4 v_m$					
103	115		$v_m$					
104	116		$1/2 v_m$					

 <b>OTIF</b>	<b>ROLLING STOCK FREIGHT WAGONS</b>		<b>UTP WAG</b> Page 130 of 151	
	Status: <b>PROPOSAL</b>		TECH-20005 Annex	Original: EN

**Table 1** (continued)

No. of brake application		Initial speed	Total $F_B$ per wheel	Initial temp.	Mass to brake per wheel	Weighing after	Remarks
		$v$	$F_B$	$\theta_0$	$m$		
		[km/h]	[kN]	[°C]	[t]	No.	
105	117	$3/4 v_m$	$F_{B2}$	50-60	$m_2$		Brake applications to rest under dry conditions, after a period of cooling
106	118	$1/4 v_m$					
107	119	$v_m$					
108	120	$1/2 v_m$					
121		$3/4 v_m$	$F_{B2}$	110-120 <sup>a</sup>	$m_2$		Brake applications to rest under dry conditions with high initial temperature, after a period of cooling
122		$1/4 v_m$					
123		$v_m$					
124		$1/2 v_m$					
125		$3/4 v_m$	$2/3 F_{B2}$	50-60	$m_2$	128	Brake applications to rest under dry conditions, after a period of cooling
126		$1/4 v_m$					
127		$v_m$					
128		$1/2 v_m$					
129		$3/4 v_m$	-	20-60	-		Simulation of a downhill brake application with a power of 45 kW for a period of 34 min
130		$3/4 v_m$	$F_{B2}$	-	$m_2$		Brake application to rest under dry conditions immediately after the simulation of a downhill brake application, without any cooling break
131 to 140		$v_m$	$2/3 F_{B2}$	50-60	$m_2$		Conditioning stops
141	145	$3/4 v_m$	$F_{B2}$	50-60	$m_2$	148	Brake applications to rest under dry conditions, after a period of cooling
142	146	$1/4 v_m$					
143	147	$v_m$					
144	148	$1/2 v_m$					
149		$3/4 v_m$	-	-	-		10 kW drag brake application for a period of 10 min in dry condition done immediately after brake n° 148 without interruption. This is to evenly distribute the residual stress within the wheel

<sup>a</sup> If the temperature obtained during stop numbers 120 and 122 is below 110 °C, stop numbers 121 and 123 shall be performed with the temperature achieved at the time.

During the tests described in table 1 the following conditions shall be respected:

 <b>OTIF</b>	<b>ROLLING STOCK</b> <b>FREIGHT WAGONS</b>		<b>UTP WAG</b> Page 131 of 151	
	Status: <b>PROPOSAL</b>		TECH-20005 Annex	Original: EN

- The speed and ventilation conditions shall be as set out in table 2.

**Table 2:** Speed and ventilation conditions

	Speed simulated on the test bench [km/h]		Speed of the cooling air [km/h]	
	Under dry conditions	Under wet conditions	Under dry conditions	Under wet conditions
During braking at v ≤ 80km/h v > 80km/h	v v	v v	v/2 40	10 10
Between the brake applications	100	50	40	10

- The time to reach 95 % of the demanded  $F_B$  shall be  $4 \text{ s} \pm 0,2 \text{ s}$ .
- During bedding-in the following minimum numbers of brake stops shall be carried out: 40 for organic friction elements and 80 for sintered friction elements.
- If interruptions of the test program occur, before recommencing the program the previous 5 stops shall be repeated. In this case the initial temperature for the first stop shall be in the range from 20 °C to 60 °C.
- In the case of an interruption prior to the first wet stop, one brake application identical to the last brake application under dry conditions shall be carried out outside of the program.
- Concerning the brake applications under wet conditions, the wheel wetting shall not be interrupted during each entire set of stops under wet conditions (including cooling period). For any first stop under wet conditions after a stop under dry conditions, the start of the wheel tread wetting shall take place only when the temperature of the wheel tread is below 80 °C.
- During the test under wet conditions the water shall be equally distributed over the wheel tread.
- During the simulation of a downhill the chosen power and speed shall be kept constant.

## 4.2 Values to be determined in order to define the area of use

The values for the following parameters shall be determined and recorded within the area of use:

- Tested configuration consisting of
  - friction element arrangement
  - wheel type
  - nominal and tested wheel diameter
- Mean dynamic friction coefficient of non-bedded and bedded state. The mean dynamic friction coefficient of the non-bedded and bedded state are defined as the average of the first 5 and the last 5 measured values of brake application n° 1.1 to 1.X.
- Mean dynamic friction coefficient under dry conditions versus the initial operating speed v for the different brake forces  $F_B$  applied and the mass to brake per wheel m using the template diagrams set out in table 3.

**Table 3:** Template diagrams and allocated brake application n°

 <b>OTIF</b>	<b>ROLLING STOCK</b> <b>FREIGHT WAGONS</b>		<b>UTP WAG</b> Page 132 of 151
	Status: <b>PROPOSAL</b>		TECH-20005 Annex

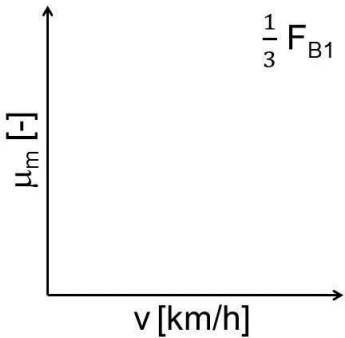
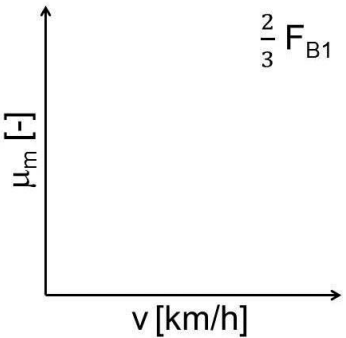
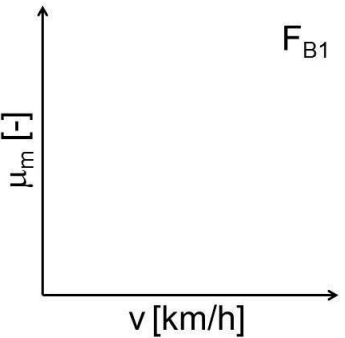
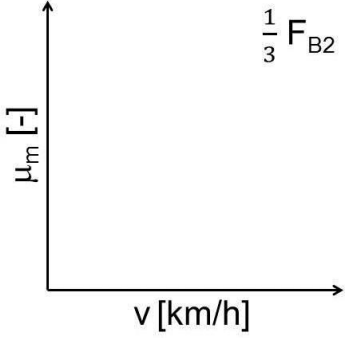
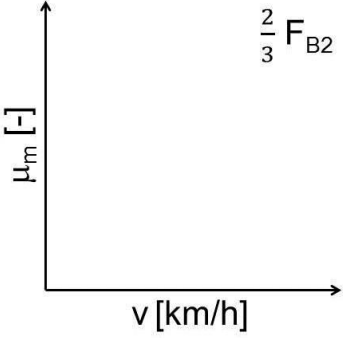
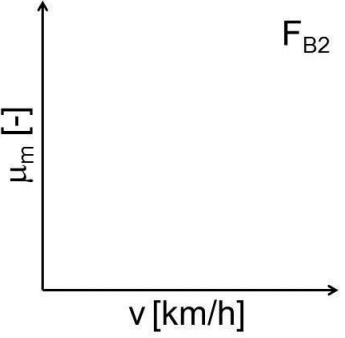
		
Brake application n° 31 to 34 and 43 to 46	Brake application n° 27 to 30 and 39 to 42	Brake application n° 35 to 38 and 47 to 50
		
Brake application n° 101 to 104 and 113 to 116	Brake application n° 97 to 100 and 109 to 112	Brake application n° 105 to 108 and 117 to 120

- d) Mean dynamic friction coefficient variation under wet conditions. The variation shall be expressed as the averages of the measured mean dynamic friction coefficients under wet conditions (brake application n° 52 to 95) in proportion to the corresponding averages of mean dynamic friction coefficients under dry conditions (brake application n° 27 to 50, 105 to 108 and 117 to 120). Example: the average value of brake applications n° 57, 69 and 81 divided by the average value of brake applications n° 32 and 44.
- e) Mean dynamic friction coefficient variation at high initial temperature. The variation shall be expressed as the mean dynamic friction coefficients at a wheel tread temperature above 110 °C (brake application n° 121 to 124) in proportion to the corresponding mean dynamic friction coefficients at a wheel tread temperature below 60 °C (brake application n° 125 to 128). Example: The value of brake application n° 122 divided by the value of brake applications n° 126.
- f) Chart of the instantaneous dynamic friction coefficient and wheel tread temperature versus time of brake application n° 129.
- g) Mean dynamic friction coefficient variation after simulation of a downhill brake application. The variation shall be expressed as the averages of the measured mean dynamic friction coefficients after downhill braking (brake application n° 141 to 148) in proportion to the corresponding averages of mean dynamic friction coefficients before downhill braking (brake application n° 105 to 108 and 117 to 120). Example: the average value of brake applications n° 142 and 146 divided by the average value of brake applications n° 106 and 118.

 <b>OTIF</b>	<b>ROLLING STOCK</b> <b>FREIGHT WAGONS</b>		<b>UTP WAG</b> Page 133 of 151
	Status: <b>PROPOSAL</b>		TECH-20005 Annex

In relation to the characteristics described in this chapter, in case the manufacturer chooses to apply some of the harmonised acceptance criteria for dynamic friction performance as specified in FprEN 16452:2014<sup>65</sup>, the compliance to these harmonised acceptance criteria have to be stated in the technical documentation as part of the area of use of the friction element for wheel tread brakes.

## 5. STATIC FRICTION COEFFICIENT

### 5.1 Test program

The dynamometer test program to determine the static friction coefficient  $\mu_{\text{stat}}$  of friction elements for wheel tread brakes is set out in table 4. The corresponding terms, definitions and abbreviations are explained in sections 2 and 3.

**Table 4:** Dynamometer test program to determine the static friction coefficient

Friction element configuration	To be defined by the applicant				
Wheel type	In conformity with EN 13979-1				
Wheel diameter	$\varnothing X \pm 5$ mm last machining size before wheel is fully worn in accordance with EN 13979-1				
No. of brake application	Initial speed	Parking brake application force	Initial temp.	Mass to brake per wheel	Remarks
	$v$	$F_{PB}$	$\theta_0$	$m$	
	[km/h]	[kN]	[°C]	[t]	
R.1 - R.X	$v_m$	$\frac{2}{3} F_{PBmax}$	20-100	$m_2$	Brake applications to rest under dry conditions to allow bedding of the friction elements up to a contact pattern of 100 % is reached
1 to 5 6 to 10 11 to 15 16 to 20	-	$\frac{1}{4} F_{PBmax}$ $\frac{1}{2} F_{PBmax}$ $\frac{3}{4} F_{PBmax}$ $F_{PBmax}$	< 30	-	-

During the test described in table 4 the following conditions shall be respected:

- The wheel tread hollow wear at the start of the test shall not exceed 1 mm. The state of the surface of the wheel tread shall be documented in the test report.
- The torque shall be continuously increased. The start of the rotation shall occur between 0,3 s and 2,0 s after the beginning of the build-up of the rotating torque.

<sup>65</sup> The reference will be changed to **EN 16452:xxxx** once this standard is published. FprEN is a stable version submitted to the formal vote within CEN.



 <b>OTIF</b>	<b>ROLLING STOCK FREIGHT WAGONS</b>		<b>UTP WAG</b> Page 134 of 151
Status: <b>PROPOSAL</b>		TECH-20005 Annex	Original: EN Date: 17.06.2020

- The relative movement between wheel and friction element shall be measured with an accuracy of at least 30 milliradian. It shall be ensured that displacements due to clearances are excluded.

For each brake application (n° 1 to 20) the static friction coefficient shall be determined which is the value of the instantaneous friction coefficient at the time corresponding to the commencement of sliding (mean value calculated from the measurement records for the intersection between the linearised characteristic line of the rotation angle and the time axis) as described in figure 1.

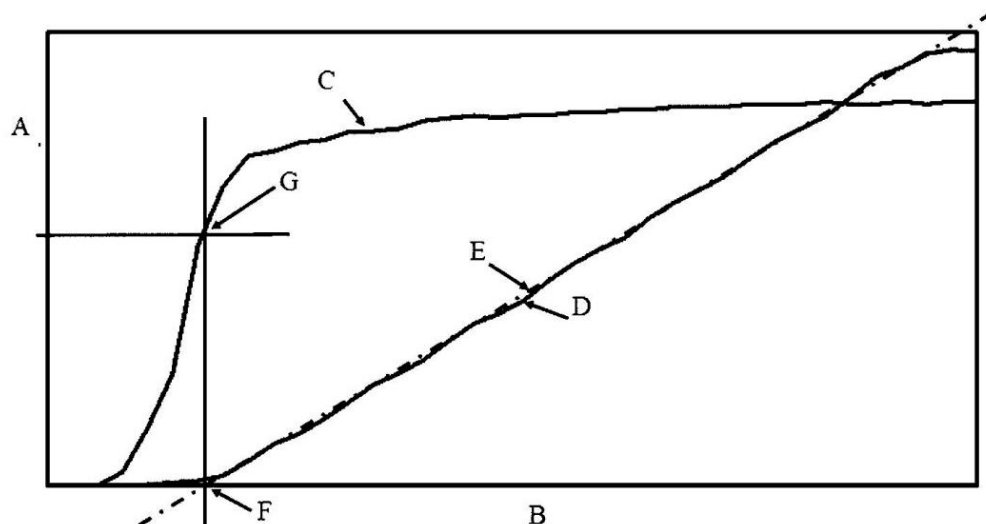

#### Key

- A friction coefficient ( $\mu$ ) / rotation angle of wheel
- B time axis
- C example of friction coefficient curve
- D rotation angle of wheel
- E straight regression line
- F intersection between straight regression line and time axis
- G value of static coefficient

**Figure 1:** Principles for the determination of the static friction coefficient

## 5.2 Values to be determined in order to define the area of use

For each force the average value of the 5 measurements shall be determined. The lowest average value is the characterising static friction coefficient.

## 6. MECHANICAL CHARACTERISTICS

The mechanical characteristics of the assembly between back plate and friction element for wheel tread brakes shall be tested in accordance with the test procedures set out in sections 6.1 and 6.2.

### 6.1 Shear strength

The test shall be performed with the mounting as set out in figure 2. In the case of a friction element consisting of two parts or a mono-bloc friction element with a central groove, a wedge (g) shall be placed in the central groove as shown.

 <b>OTIF</b>	<b>ROLLING STOCK</b> <b>FREIGHT WAGONS</b>		<b>UTP WAG</b> Page 135 of 151
	Status: <b>PROPOSAL</b>	TECH-20005 Annex	Original: EN

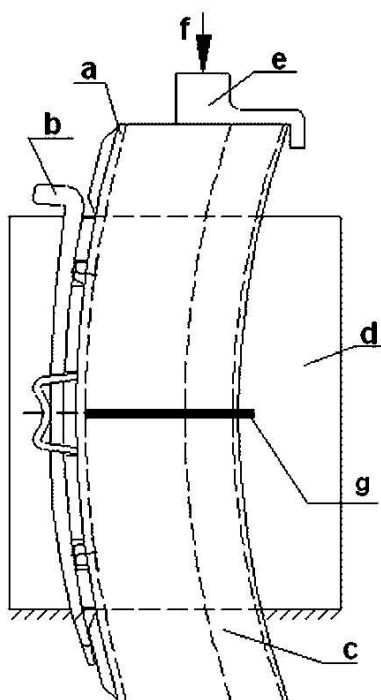

### Key

- a brake shoe insert back plate
- b brake shoe insert fixing key
- c friction element
- d side panel
- e force application fixing
- f test force  $F_{test}$
- g brake shoe insert groove filling device

**Figure 2:** Shear strength test mounting arrangement

The test force  $F_{test}$  shall be applied in a continuous and progressive way up to 1.5 times the maximum permissible braking force applied at one friction element within 4 s and shall be kept for a period of at least 2 min.

At the end of the test there shall not be any indication of detachment of the back plate from the friction element or any other visible mechanical damage.

## 6.2 Flexural strength

Two tests shall be performed, one with the mounting 1 and one with the mounting 2 as set out in figure 3. The end of the supports shall have a radius of 5 mm. For both tests new friction elements shall be used and the test force  $F_{test}$  shall be applied five times.  $F_{test}$  is the maximum permissible application force applied at one friction element.

The following distances shall be respected:

 <b>OTIF</b>	<b>ROLLING STOCK</b> <b>FREIGHT WAGONS</b>		<b>UTP WAG</b> Page 136 of 151
	Status: <b>PROPOSAL</b>	TECH-20005 Annex	Original: EN

- Ls 1 = friction element length - 50 mm.
- Ls 2 = half friction element length - 50 mm.

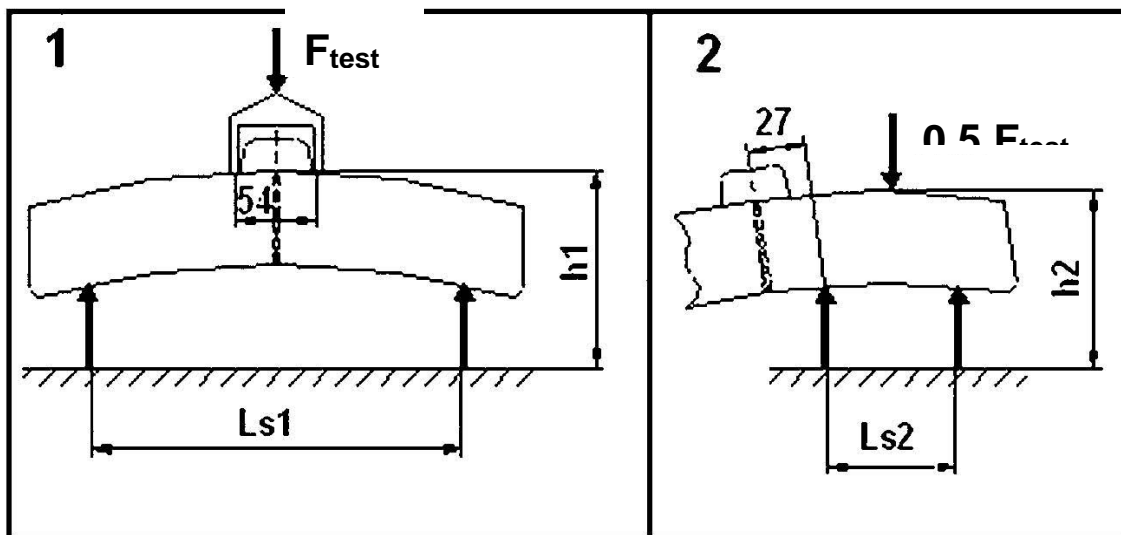

#### Key

- 1 mounting for performing test n°1
- 2 mounting for performing test n°2

**Figure 3:** Flexural strength test mounting arrangement

Within 4 s the test force shall be applied progressively until either the maximum test force  $F_{test}$  is achieved or the maximum displacement  $\square h1$  respectively  $\square h2$  for the intended application occurs taking into account the nominal geometry of a new friction element and a new wheel.

The force respectively the displacement shall be kept for a period of at least 2 minutes.

At the end of the test, the friction element shall not show any crack initiation or fracture of the back plate. In the case of a friction element that has a groove or slot as shown in figure 3 cracking is permitted in the area where the friction element is at its thinnest where the groove meets the back plate.

## 7. SUITABILITY FOR TRAIN DETECTION BY SYSTEMS BASED ON TRACK CIRCUITS

The following rig test to demonstrate the suitability for train detection by systems based on track circuits is only applicable if the friction element is intended to be used in subsystems which fall under the following scope:

- Nominal wheel diameters of 680 mm to 920 mm
- Friction element configurations 1Bg, 1Bgu, 2Bg and 2Bgu
- Mass per wheel  $\geq 1.8$  t

Cast iron brake blocks are deemed to be suitable for train detection by systems based on track circuits.

### 7.1 Test program

 <b>OTIF</b>	<b>ROLLING STOCK</b> <b>FREIGHT WAGONS</b>		<b>UTP WAG</b> Page 137 of 151
	Status: <b>PROPOSAL</b>	TECH-20005 Annex	Original: EN

A number of 10 friction element samples of a given size as set out in clause 7.1.3 shall be subject to the test program provided in figure 4 and further described in clauses 7.1.1 to 7.1.6.

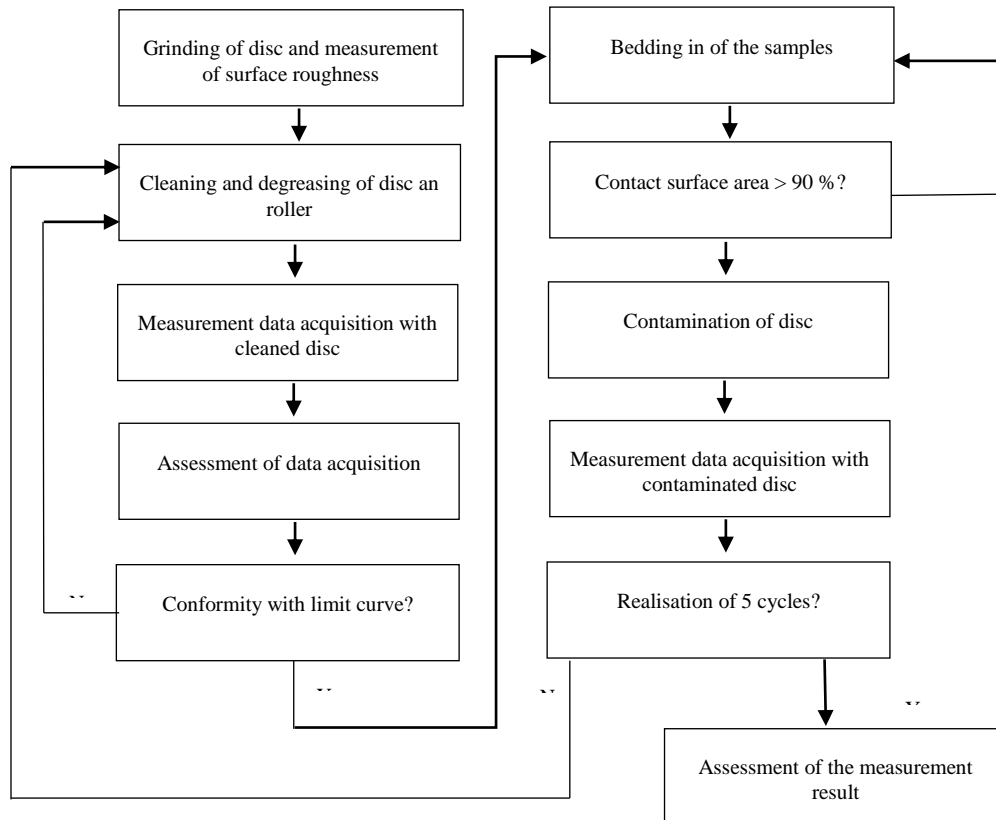

**Figure 4:** Flow chart of the test program

### 7.1.1 Grinding of disc and measurement of surface roughness

Before the first test of each pair of friction element samples the disc shall be grinded and the surface roughness  $R_z$  (maximum height of profile) shall be lower than or equal to  $12 \mu\text{m}$ .

### 7.1.2 Cleaning and degreasing of disc and roller

The disc shall be cleaned and degreased with emery paper of grade 180, cloths in micro-fibres and of water/spray acetone in order to remove the residual material and satins from previous tests.

The roller and the surface of the carbon brush shall be cleaned and degreased in order to remove dust particles adhering to the surface.

### 7.1.3 Cutting of the samples

The cutting of samples shall be carried out without lubrication. The samples shall be cut along the friction surface of the friction element. The friction surface of the samples shall be the one which was originally the closest to the friction surface of the friction element in order to maintain the original application orientation of the material. The sample dimensions are provided in figure 5.

 <b>OTIF</b>	<b>ROLLING STOCK</b> <b>FREIGHT WAGONS</b>		<b>UTP WAG</b> Page 138 of 151	
	Status: <b>PROPOSAL</b>		TECH-20005 Annex	Original: EN

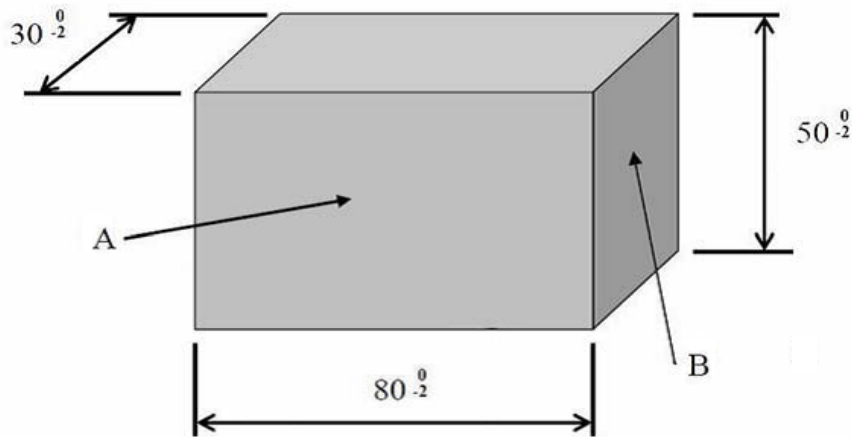

#### Key

A Friction surface of a sample

B Other surface

**Figure 5:** Sample

#### 7.1.4 Bedding in of samples

For each cycle two new samples shall be bedded in. The bedding in shall be performed by stop brakings on the cleaned and degreased disc under the following conditions:

- Speed of 100 km/h in the centre of the samples' friction surface
- Braked mass of 0,41 t
- Surface pressure of 40 N/cm<sup>2</sup>

The bedding in shall achieve a contact surface area of more than 90 %.

#### 7.1.5 Contamination of disc

The disc shall be contaminated by continuous braking under the following conditions:

- Speed of 70 km/h in the centre of the samples' friction surface
- Brake torque of 51 Nm
- The contamination phase ends as soon as the disc temperature has reached 400 °C or after 2 400 s of continuous braking

Before carrying out the measurement as described in clause 7.1.6 the disc shall be cooled down below 40 °C.

#### 7.1.6 Measurements

The measurement of the impedance shall be carried out with a measurement set up as schematically described in figure 6.

 <b>OTIF</b>	<b>ROLLING STOCK FREIGHT WAGONS</b>		<b>UTP WAG</b> Page 139 of 151
	Status: <b>PROPOSAL</b>	TECH-20005 Annex	Original: EN

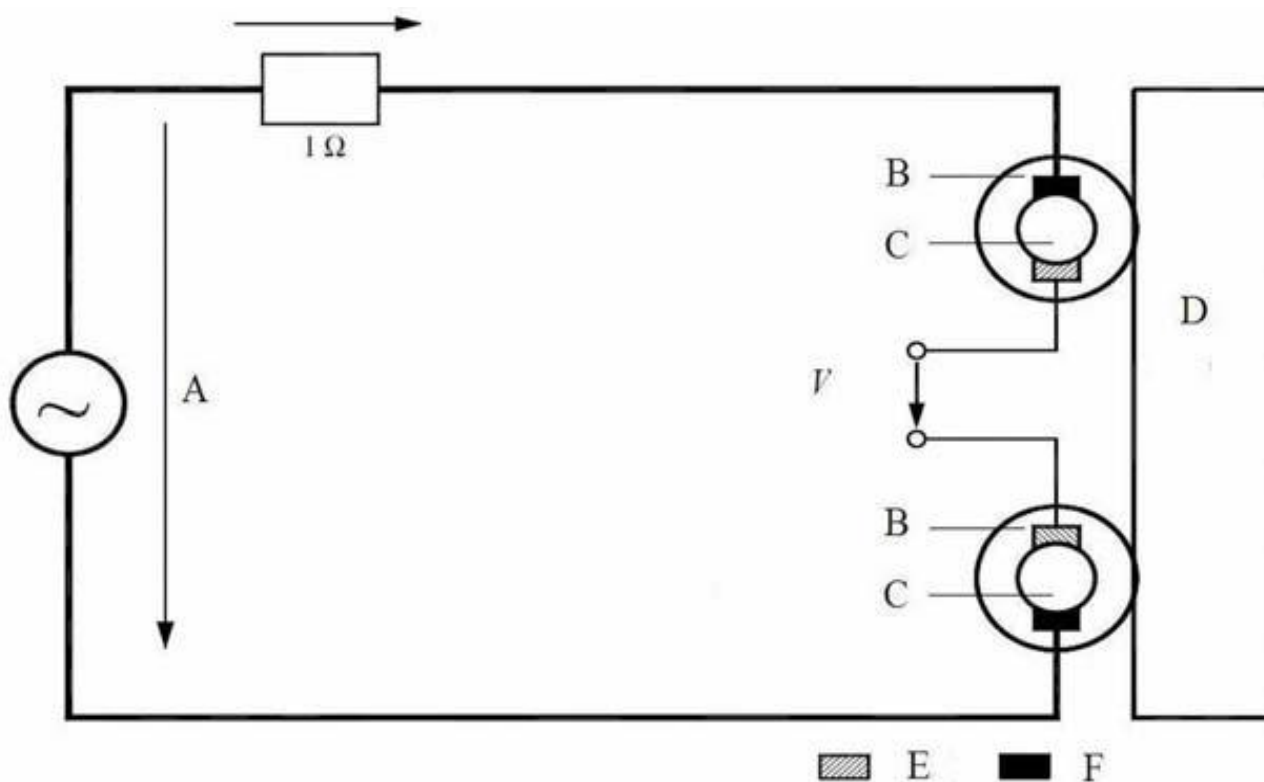

### Key

A Applied voltage (electrical cycle)

C Shaft made of copper

E Carbon brush – measured voltage

V Measured voltage

B Roller made of rail steel

D Disc made of wheel steel (clean/contaminated)

F Carbon brush – applied voltage

**Figure 6:** Schematic diagram of the measurement set up

The electrical contact to the disc is achieved by means of two rollers with a contact force of 14 N each (view of rollers, shaft and brushes in figure 6 are rotated by 90°).

The impedance measurement

- of the cleaned disc and
- of the contaminated disc

relates to four different measuring traces equally distributed over the radius in the contaminated area. In accordance with figure 4 five measurement cycles shall be conducted, so that the impedance of 20 traces is measured at a total.

The impedance on each trace is measured both statically and dynamically by applying the electrical cycle as defined in figure 7. During the dynamical measurement the disc shall rotate at a speed of 60 rpm.

 <b>OTIF</b>	<b>ROLLING STOCK FREIGHT WAGONS</b>		<b>UTP WAG</b> Page 140 of 151
	Status: <b>PROPOSAL</b>	TECH-20005 Annex	Original: EN

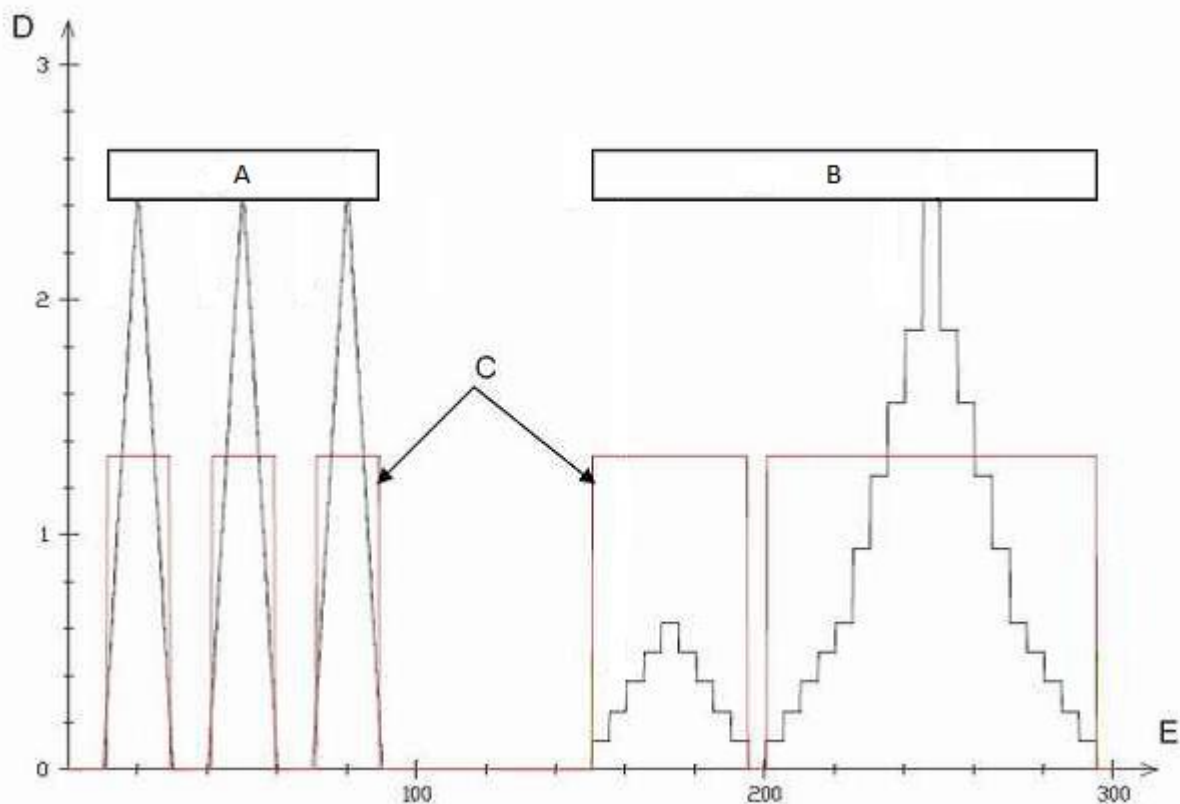

### Key

A Static tests

B Dynamic tests

C Area for measurements

D Applied voltage [V]

E Time [s]

**Figure 7:** Electrical cycle

The resulting current and voltage are measured by a four-wire impedance measurement method and digitalized. The frequency of applied voltage and current is set to 42 Hz. A summation and a verified sliding mean value averaging provide a new impedance value every 10 ms.

## 7.2 Assessment of the measurement results

An automatic evaluation of the results shall be carried out.

The (several hundred thousand) impedance values obtained during the course of the measurements shall be allocated to the impedance classes indicated as 'B' in figures 8 and 9. The total number of impedance values of each impedance class shall be compared with the limit values indicated as 'C' in figures 8 and 9.

The number of impedance values measured with the cleaned disc shall be lower in each impedance class than the corresponding limit values as set out in figure 8. If the limit values are not respected, the cleaning of the disc shall be carried out once again as described in figure 4.

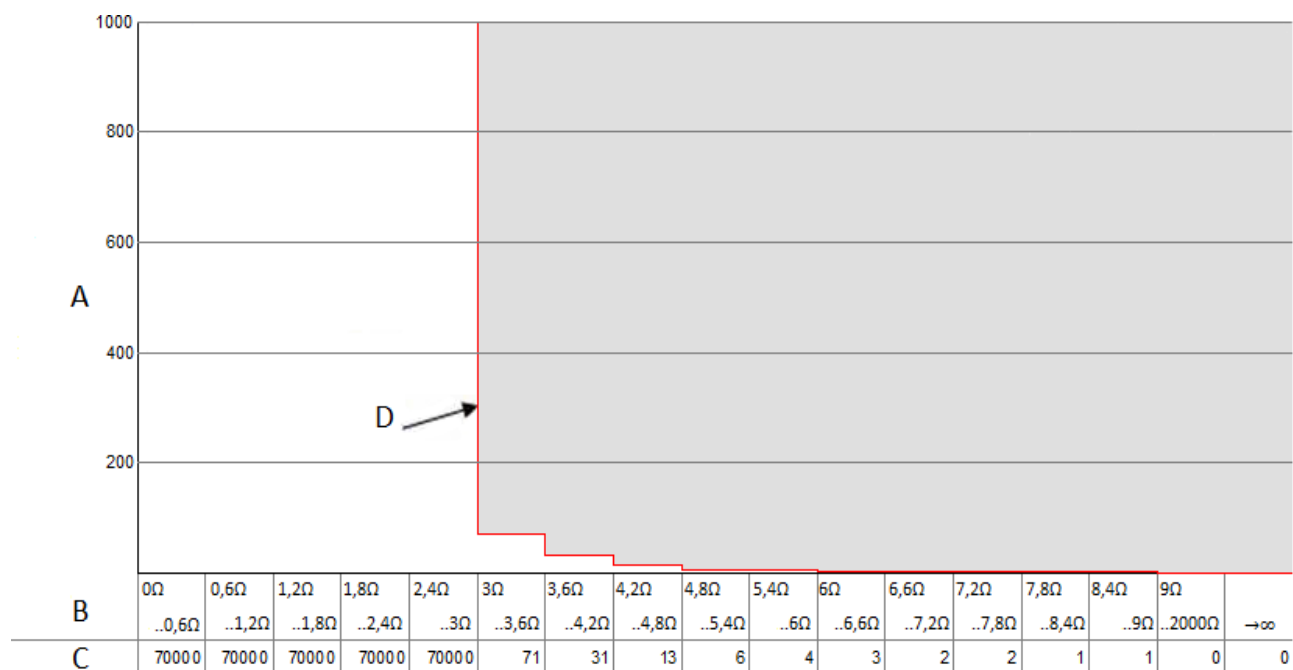

### Key

A Frequency distribution of impedance per class

B Impedance classes

C Limit values of frequency distribution of impedance per class

D Limit curve

**Figure 8:** Limit values per impedance class for cleaned disc

The number of impedance values measured with the contaminated disc shall be lower in each impedance class than the corresponding limit values as set out in figure 9.



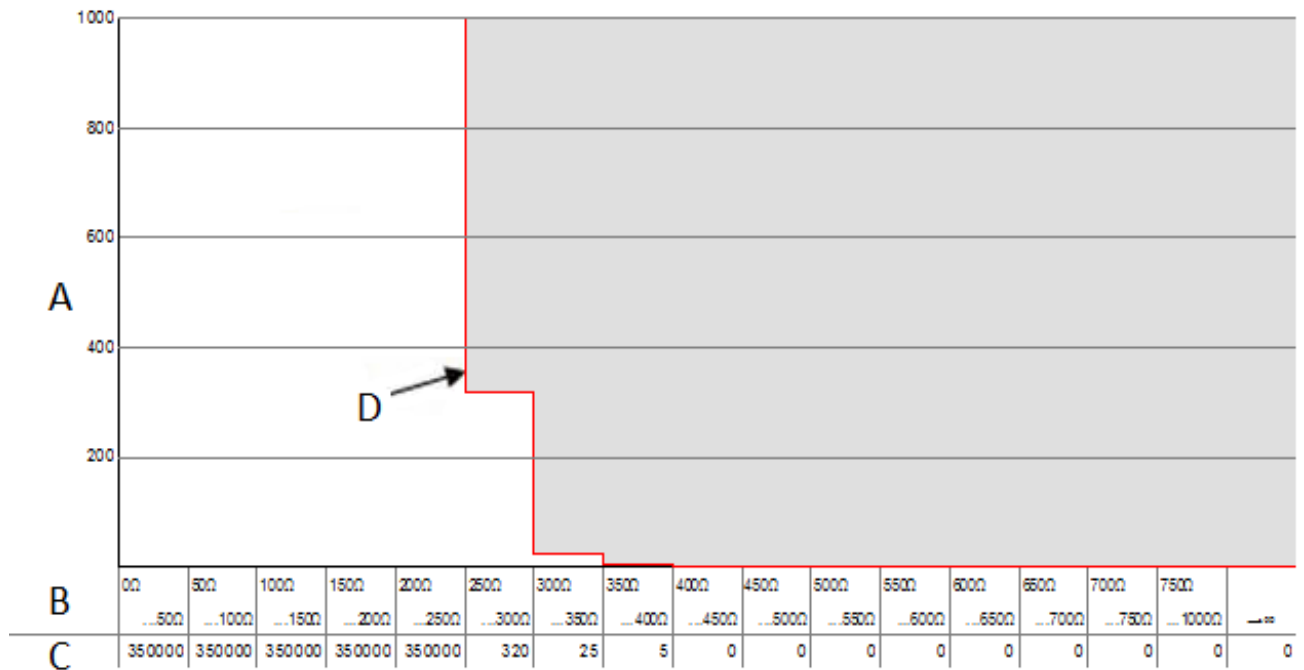

### Key

- A Frequency distribution of impedance per class
- B Impedance classes
- C Limit values of frequency distribution of impedance per class
- D Limit curve

**Figure 9:** Limit values per impedance class for contaminated disc

## 8. SUITABILITY FOR SEVERE ENVIRONMENTAL CONDITIONS

The suitability of the friction element acting on wheel tread brakes for severe environmental conditions shall be tested in accordance with the test procedures set out in sections 8.1 or 8.2. The corresponding terms, definitions and abbreviations are explained in sections 2 and 3.

Cast iron brake blocks are deemed to be suitable for severe environmental conditions.

### 8.1 Test run

#### 8.1.1 Test program to demonstrate the braking properties under severe environmental conditions

The goal of this test run is to compare the results of tests without snow fly-off ('reference tests') with those with snow fly-off ('winter tests') and to determine the braking properties of friction elements acting on wheel tread brakes for severe environmental conditions under real conditions of use.

'Reference tests' and 'winter tests' shall be performed consecutively within one single period of up to 4 weeks. A running period of at least 10 min is to be observed between brake applications, with a maximum of 4 brake applications performed per hour.

The brake initiation speeds shall be

 <b>OTIF</b>	<b>ROLLING STOCK FREIGHT WAGONS</b>		<b>UTP WAG</b> Page 143 of 151	
Status: <b>PROPOSAL</b>		TECH-20005 Annex	Original: EN	Date: 17.06.2020

- 60 km/h (for information purposes, to monitor the plausibility and comparability of the efficiency between ‘reference tests’ and ‘winter tests’),
- if the maximum speed is 100 km/h or more: 85 % of the intended maximum speed but not more than 100 km/h, and
- 100 % of the intended maximum speed

respectively.

The tests shall be performed...

- ...with a train consisting of one locomotive and 5 wagons fulfilling the following:
  - The locomotive shall have disconnected dynamic and indirect braking.
  - The maximum dynamic mass of the locomotive shall be lower than 100 t.
  - The test wagons shall be of the same design with the same equipment and have an ‘open’ bogie design e.g. Y25.
  - The wheelset load when empty (without payload) shall be max. 7 t.
  - The arrangement of the friction elements shall be the one with the lowest intended specific pressure at emergency brake.
  - The emergency brake shall be applied.
  - The bedding in shall achieve a contact surface area of more than 85 %.
- ...on lines with mean gradient over the stopping distance lower than 3 ‰; maximum gradient lower than or equal to 5 ‰ and curve radii higher than or equal to 1000 m
- ...under the following environmental conditions:
  - ‘Reference test’: No snow fly-off (snow level 0, see figure 10) at external temperatures of up to + 5 °C.
  - ‘Winter tests’: During the winter semester with snow on the lines and with snow fly-off (snow level 3 to 5, see figures 11 and 12) at external temperatures between zero and -10 °C.

 <b>OTIF</b>	<b>ROLLING STOCK FREIGHT WAGONS</b>		<b>UTP WAG</b> Page 144 of 151
Status: <b>PROPOSAL</b>		TECH-20005 Annex	Original: EN
Date: 17.06.2020			



**Figure 10:** Reference test (snow level 0)



**Figure 11:** Winter test (snow level 2 to 3)

 <b>OTIF</b>	<b>ROLLING STOCK FREIGHT WAGONS</b>		<b>UTP WAG</b> Page 145 of 151	
Status: <b>PROPOSAL</b>		TECH-20005 Annex	Original: EN	Date: 17.06.2020



**Figure 12:** Winter test (snow level 4 to 5)

The number of ‘reference tests’ shall be at least 8 and maximum 20 for each brake initiation speed (60 km/h excluded) whereby the quotient of the standard deviation and the average braking distance shall not exceed 10 %.

The number of ‘winter tests’ shall be at least 8 (60 km/h excluded) whereby the quotient of the standard deviation and the average braking distance shall not exceed 20 % to ensure that the braking distance is representative for the assessment.

The following values shall be measured:

- Speed
- Braking distance
- Time
- Brake pipe pressure
- External temperature

### **8.1.2 Values to be determined in order to define the area of use**

The average braking distances of the ‘winter tests’ at each speed and the average braking distances of the ‘reference tests’ shall be determined.

 <b>OTIF</b>	<b>ROLLING STOCK</b> <b>FREIGHT WAGONS</b>		<b>UTP WAG</b> Page 146 of 151	
	Status: <b>PROPOSAL</b>		TECH-20005 Annex	Original: EN

## 8.2 Dynamometer test

### 8.2.1 Test program to demonstrate the braking properties under severe environmental conditions

The dynamometer test program to demonstrate the extreme winter braking properties is set out in table 6 and table 7 and is only applicable if the friction element...

- ...is intended to be used in subsystems which fall under the following scope:
  - Nominal wheel diameters of 680 mm to 920 mm
  - Friction element configuration
    - 1Bg (if the test was performed in configuration 1Bg or 2Bgu)
    - 1Bgu (if the test was performed in configuration 1Bgu or 2Bgu)
    - 2Bg (if the test was performed in configuration 2Bg or 2Bgu)
    - 2Bgu (if the test was performed in configuration 2Bgu)
  - Mass per wheel  $\geq 1.8$  t
- ...complies with one of the following cases of the mean dynamic friction coefficient as determined in accordance with section 4.2 point b):

**Table 5:** Cases of the mean dynamic friction coefficient

Case	Mean dynamic friction coefficient	Total $F_B$ per wheel	Initial speed
		$F_B$	$v$
		[kN]	[km/h]
1	$0,28 < \mu_m < 0,32$	9	100
2	$0,27 < \mu_m < 0,31$	9	120
3	$0,17 < \mu_m < 0,19$	16	100
4	$0,16 < \mu_m < 0,18$	16	120

To demonstrate the extreme winter braking properties of friction elements complying with cases 1 and 2 of table 5 the test program of table 6 shall be applied, for friction elements complying with cases 3 and 4 of table 5 the test program of table 7 shall be applied.

 <b>OTIF</b>	<b>ROLLING STOCK</b> <b>FREIGHT WAGONS</b>		<b>UTP WAG</b> Page 147 of 151	
	Status: <b>PROPOSAL</b>		TECH-20005 Annex	Original: EN

**Table 6:** Dynamometer test program – friction elements cases 1 and 2

Friction element configuration						1Bg, 1Bgu, 2Bg or 2Bgu					
Wheel type						In conformity with EN 13979-1					
Wheel diameter						$\varnothing X \pm 5$ mm last machining size before wheel is fully worn to EN 13979-1					
No. of brake application						Initial speed	Total $F_B$ per wheel	Initial temp.	Mass to brake per wheel	Remarks	
						$v$	$F_B$	$\theta_0$	$m_{IW}$		
						[km/h]	[kN]	[°C]	[t]		
R.1 - R.X						100	12	20 to 100	7,5	Brake applications to rest under dry conditions to allow bedding of the friction elements up to a contact pattern of 100 % is reached	
R.X + 1 to R.X + 20						100	12	20 to 100	2,5	20 brake applications to a stop (dry)	
1 to 5						100	9	-5 to 60	2,5	Conditioning	
6	8	10	12	14	100	9	50 to 60	2,5	Dry brake applications, warm		
7	9	11	13	15	120			2,5			
16	18	20	22	24	100	9	-5 to -3	2,5	Dry brake applications, cold (reference brake applications)		
17	19	21	23	25	120			2,5			
										Test snow machine and snow quality	
26 to 28						120	9	-5 to 90	2,5	Conditioning	
a29	a33	a37	a42	a46	20				Cooling, dry to -3 °C		
b29	b33	b37	b42	b46	100				Rotating, dry, over 240 s		
c29	c33	c37	c42	c46	100				Rotating, with artificial snow over 340 s		
29	33	37	42	46	100	9		2,5	Braking with artificial snow		
30	34	38	43	47	120	9	-5 to 90	2,5	Conditioning, dry		

 <b>OTIF</b>	<b>ROLLING STOCK FREIGHT WAGONS</b>			<b>UTP WAG</b> Page 148 of 151
	Status: <b>PROPOSAL</b>		TECH-20005 Annex	Original: EN

**Table 6** (continued)

No. of brake application					Initial speed	Total $F_B$ per wheel	Initial temp.	Mass to brake per wheel	Remarks
					$v$	$F_B$	$\theta_0$	$m_W$	
					[km/h]	[kN]	[°C]	[t]	
a31	a35	a39	a44	a48	20				Cooling, dry to -3 °C
b31	b35	b39	b44	b48	120				Rotating, dry, over 240 s
c31	c35	c39	c44	c48	120				Rotating with artificial snow over 900 s
31	35	39	44	48	120	9		2,5	Braking with artificial snow
32	36	40	45	49	120	9	-5 to 90	2,5	Conditioning, dry
		41			120	9	-5 to 90	2,5	Conditioning, dry

**Table 7:** Dynamometer test program – friction elements cases 3 and 4

Friction element configuration	1Bg, 1Bgu, 2Bg or 2Bgu				
Wheel type	In conformity with EN 13979-1				
Wheel diameter	$\varnothing X \pm 5$ mm last machining size before wheel is fully worn to EN 13979-1				
No. of brake application	Initial speed	Total $F_B$ per wheel	Initial temp.	Mass to brake per wheel	Remarks
	$v$	$F_B$	$\theta_0$	$m_{IW}$	
	[km/h]	[kN]	[°C]	[t]	
R.1 - R.X	100	30	20 to 100	7,5	Brake applications to rest under dry conditions to allow bedding of the friction elements up to a contact pattern of 100 % is reached
R.X + 1 to R.X + 20	100	30	20 to 100	2,63	20 brake applications to a stop (dry)
1 to 5	100	16	-5 to 60	2,63	Conditioning

 <b>OTIF</b>	<b>ROLLING STOCK FREIGHT WAGONS</b>			<b>UTP WAG</b> Page 149 of 151
	Status: <b>PROPOSAL</b>		TECH-20005 Annex	Original: EN

**Table 7** (continued)

No. of brake application					Initial speed	Total $F_B$ per wheel	Initial temp.	Mass to brake per wheel	Remarks
					$v$	$F_B$	$\theta_0$	$m_w$	
					[km/h]	[kN]	[°C]	[t]	
6	8	10	12	14	100	16	50 to 60	2,63	Dry brake applications, warm
7	9	11	13	15	120			2,63	
16	18	20	22	24	100	16	-5 to -3	2,63	Dry brake applications, cold (reference brake applications)
17	19	21	23	25	120			2,63	
									Test snow machine and snow quality
26 to 28					120	16	-5 to 90	2,63	Conditioning
a29	a33	a37	a42	a46	20				Cooling, dry to -3 °C
b29	b33	b37	b42	b46	100				Rotating, dry, over 240 s
c29	c33	c37	c42	c46	100				Rotating with artificial snow over 340 s
29	33	37	42	46	100	16		2,63	Braking with artificial snow
30	34	38	43	47	120	16	-5 to 90	2,63	Conditioning, dry
a31	a35	a39	a44	a48	20				Cooling, dry to -3 °C
b31	b35	b39	b44	b48	120				Rotating, dry, over 240 s
c31	c35	c39	c44	c48	120				Rotating with artificial snow over 900 s
31	35	39	44	48	120	16		2,63	Braking with artificial snow
32	36	40	45	49	120	16	-5 to 90	2,63	Conditioning, dry
		41			120	16	-5 to 90	2,63	Conditioning, dry



 <b>OTIF</b>	<b>ROLLING STOCK</b> <b>FREIGHT WAGONS</b>		<b>UTP WAG</b> Page 150 of 151	
	Status: <b>PROPOSAL</b>		TECH-20005 Annex	Original: EN

During the tests described in tables 6 and 7 the following conditions shall be respected:

- The cooling air speed shall be as set out in table 8.

**Table 8:** Cooling air speed

	Speed simulated on the test bench [km/h]		Speed of the cooling air [km/h]	
	Under dry conditions	With snow	Under dry conditions	With snow
During braking	v	v	25	25
Between the brake applications	v	v	25	25

- The brake build-up time shall be  $8 \text{ s} \pm 0,2 \text{ s}$ .
- During bedding-in the following minimum numbers of brake stops shall be carried out: 40 for organic friction elements and 80 for sintered friction elements.
- All test equipment shall initially have a homogeneous temperature of  $-7 \text{ }^\circ\text{C} \pm 2 \text{ }^\circ\text{C}$ . The test chamber temperature shall be  $-7 \text{ }^\circ\text{C} \pm 2 \text{ }^\circ\text{C}$ . The required temperature should therefore be reached in the test chamber at least 12 h before the start of the programme (brake application n° 1).
- The snow shall be dry. Its calculated weight shall be 45 - 52 g per 250 ml measuring cup. It shall fall apart after being pressed in a palm. During the cooling periods with artificial snow and the subsequent brake applications with artificial snow, the flow of artificial snow shall not be interrupted.
- Five valid brake applications under snow (at 100 km/h and 120 km/h) are required.
- Any irregularities during testing on the friction element and the wheel contact surfaces are to be recorded and documented.
- If interruptions occur between brake applications n° 29 to 49 (e. g. due to equipment problems as a result of iced-over snow nozzles), the programme is to be continued by repeating the last conditioning brake application and the subsequent cooling operations. These interruptions are to be recorded in the test report.

## 8.2.2 Values to be determined in order to define the area of use

The test program shall be carried out three times and the establishment of the suitability shall be done for a maximum test speed of 100 km/h and 120 km/h as follows:

- For a maximum speed of 100 km/h the deviation of the average value of the measured stopping distances  $s_1$  under snow (brake application n° 29, 33, 37, 42 and 46) from the average value of the measured stopping distances  $s_1$  under dry conditions (brake application n° 16, 18, 20, 22 and 24) shall be determined.
- For a maximum speed of 120 km/h the deviation of the average value of the measured stopping distances  $s_1$  under snow (brake application n° 31, 35, 39, 44 and 48) from the average value of the measured stopping distances  $s_1$  under dry conditions (brake application n° 17, 19, 21, 23 and 25) shall be determined.

 <b>OTIF</b>	<b>ROLLING STOCK FREIGHT WAGONS</b>			<b>UTP WAG</b> Page 151 of 151
Status: <b>PROPOSAL</b>		TECH-20005 Annex	Original: EN	Date: 17.06.2020

## 9. THERMOMECHANICAL CHARACTERISTICS

The thermomechanical analysis to be performed at subsystem level (freight wagon) is specified in the point 4.2.4.3.3 of the [UTP WAG TSI](#) for the brake system and in the point 4.2.3.6.3 of the [UTP WAG TSI](#) for the wheel, taking into account the area of use of the freight wagon.

At the interoperability constituent level (friction element for wheel tread brakes) it is allowed to take into account for the brake application No 129 of Table 1 a more demanding slope than those suggested in the column Remarks; the slope taken into account has then to be recorded in the technical documentation as part of the area of use of the friction element for wheel tread brakes.

At the interoperability constituent level (friction element for wheel tread brakes), in case the manufacturer chooses to perform the test to simulate 'locked brake' as specified in FprEN 16452:2014<sup>66</sup>, the result of this test has to be recorded in the technical documentation as part of the area of use of the friction element for wheel tread brakes.

---

<sup>66</sup> The reference will be changed to EN 16452:xxxx once this standard is published. FprEN is a stable version submitted to the formal vote within CEN.