



Organisation intergouvernementale pour les transports internationaux ferroviaires
Zwischenstaatliche Organisation für den internationalen Eisenbahnverkehr
Intergovernmental Organisation for International Carriage by Rail

**Commission d'experts techniques
Fachausschuss für technische Fragen
Committee of Technical Experts**

TECH-25004-CTE17-4.2

24.02.2025

Original: EN

17TH SESSION

Proposal for the revision of the Uniform Technical Prescription applicable to the accessibility of the rail system for persons with disabilities and persons with reduced mobility

UTP PRM

1. INTRODUCTION

In accordance with Article 20 § 1 b) of COTIF and Article 6 of Appendix F to COTIF (the APTU Uniform Rules), the Committee of Technical Experts (CTE) is competent to take decisions about the adoption of a Uniform Technical Prescription (UTP) or a provision amending a UTP.

This proposal concerns the revision of the UTP applicable to the accessibility of the rail system for persons with disabilities and persons with reduced mobility, the UTP PRM, in the version of 1 January 2022.

The proposal has been developed on the basis of COTIF as last modified on 1 November 2023, in particular with regard to Article 8 of the APTU Uniform Rules.

2. CONTEXT AND SUBSTANCE OF THE PROPOSAL

The aim of this proposal to revise the UTP PRM is to keep it aligned with legal developments in the European Union. Furthermore, the proposal clarifies the scope of the UTP PRM with regard to vehicles and with regard to other subsystems. In particular, the application of the UTP PRM is generally mandatory for new passenger rolling stock that is admitted to international traffic in accordance with the ATMF UR. The UTP PRM also describes optional parameters for the infrastructure, operational and telematics subsystems.

The proposed modifications include:

- Clarifications concerning the scope and application of the UTP;
- An update of the references to EU legislation and to standards;
- Modified provisions concerning audible signals related to passenger door opening and closing;
- Modified and additional provisions concerning dynamic route information in and on trains;
- Update of the implementation rules, in accordance with the implementation rules of the UTP LOC&PAS;
- Editorial modifications to align the UTP with the latest practice.

The proposed modifications are shown for information in Annex 1.

The consolidated new version of the UTP PRM proposed for adoption is in Annex 2.

The version of 1 January 2022 should be repealed and replaced by the consolidated new version, when it enters into force.

3. PREPARATORY WORK

The proposal was prepared by the OTIF Secretariat in coordination with WG Tech. The first draft version was reviewed by WG Tech at its 52nd session (Bern, 13 June 2024). Updated drafts were subsequently reviewed at the 53rd session of WG Tech (Ittigen, 17 September 2024) and at the 54th session of WG Tech (Belgrade, 19 November 2024).

Switzerland requested that its specific case be removed, as it was covered in a national technical requirement notified in accordance with Article 12 of the APTU UR.

4. JUSTIFICATION FOR THE AMENDMENTS

In order to ensure the continued mutual acceptance in international traffic of vehicles authorised in accordance with European Union law and of vehicles admitted to international operation in accordance with COTIF, it is essential that the European Union TSIs and COTIF UTPs remain aligned.

The aim of the proposal is to maintain equivalence in the meaning of Article 13 § 4 letter b) of the APTU Uniform Rules between the UTP and the TSI with regard to vehicles, so that the mechanisms of reciprocity as set out in Article 3a of the ATMF Uniform Rules continue to function.

With regard to vehicles, the UTP PRM of 1 January 2022 is equivalent to the European Union's technical specification for interoperability (TSI) set out in Commission Regulation (EU) No 1300/2014 of 18 November as last amended by Commission Implementing Regulation (EU) 2019/772 of 16 May 2019. The TSI was last amended by Commission Implementing Regulation (EU) 2023/1694 of 10 August 2023. The proposed UTP modifications would align the UTP with the most recent TSI.

In addition, specific cases should be updated with regard to non-EU Contracting States¹, in particular by deleting the specific case for Switzerland.

PROPOSALS FOR DECISION

- In accordance with Article 20 § 1 and Article 35 of COTIF and Article 6 § 1 of the APTU UR, the Committee of Technical Experts adopts a consolidated new version of the Uniform Technical Prescription applicable to the accessibility of the rail system for persons with disabilities and persons with reduced mobility (UTP PRM) as set out in Annex 2 to document TECH-25004-CTE17-4.2 of 24 February 2025[, as modified at the session]. The UTP PRM of 1 January 2022 is repealed and is replaced by the consolidated new version from the moment of entry into force of the consolidated new version.
- The Committee of Technical Experts instructs the Secretary General to publish the new version of the UTP PRM on OTIF's website, although the repealed version should also remain available online for future reference.

¹ The UTP refers to TSI with regard to the specific cases for the Member States of the European Union.



Organisation intergouvernementale pour les transports internationaux ferroviaires

Zwischenstaatliche Organisation für den internationalen Eisenbahnverkehr

Intergovernmental Organisation for International Carriage by Rail

TECH-25004 Annex 1

Uniform Technical Prescription

Applicable to the
accessibility of the rail
system for persons with
disabilities and persons
with reduced mobility

UTP PRM

Applicable from [Click here to enter a date.](#)

| | | | |
|---|--|--------------------|------------------|
|  OTIF | Uniform Technical Prescription | | UTP PRM |
| | Accessibility for persons with disabilities and persons with reduced mobility | | Page 2 of 112 |
| Status: PROPOSAL | | TECH-25004 Annex 1 | Original: EN |
| | | | Date: 24.02.2025 |

APTU Uniform Rules (Appendix F to COTIF 1999)

Uniform Technical Prescription

applicable to the accessibility of the rail system for persons with disabilities and persons with reduced mobility

(UTP PRM)

This UTP has been developed in accordance with COTIF ~~1999 in the version of~~ [as last modified on 1 March 2019](#) ~~November 2023~~ and in particular with Articles 3, 4, 6, 7, 7a and 8 of the APTU Uniform Rules (Appendix F to COTIF).

For definitions, see also Article 2 of the APTU Uniform Rules and Article 2 of the ATMF Uniform Rules (Appendix G to COTIF).

[Footnotes are not legal provisions. They include both explanatory information and references to other regulations.](#)

0. EQUIVALENCE AND ~~APPLICATION~~ **TRANSITIONAL PROVISIONS**

0.1 Equivalence

(1) [Following their adoption by the Committee of Technical Experts, the OTIF provisions regarding the rolling stock subsystem in; this UTP are](#) ~~is~~ [equivalent to the corresponding European Union \(EU\) regulations within the meaning of Article 13 § 4 letter b\) of the APTU UR and Article 3a of the ATMF UR, in particular with:](#)

- [Commission Regulation \(EU\) No 1300/2014 of 18 November 2014, as last amended by Commission Implementing Regulation \(EU\) ~~2023/1694 of 10 August 2023, 2019/772 of 16 May 2019 \(PRM TSI\)~~ with respect to vehicle related requirements, which is further hereinafter referred to as the PRM TSI.](#)

[The equivalence is limited to the scope as defined in Chapters 1 and 2 of this UTP.](#)

| | | | |
|---|--|--------------------|------------------|
|  OTIF | Uniform Technical Prescription | | UTP PRM |
| | Accessibility for persons with disabilities and persons with reduced mobility | | Page 3 of 112 |
| Status: PROPOSAL | | TECH-25004 Annex 1 | Original: EN |
| | | | Date: 24.02.2025 |

- (2) The aim of this UTP is to prescribe exhaustively the ~~vehicle-related~~ requirements for the accessibility of vehicles used in international traffic for persons with disabilities and persons with reduced mobility ~~for the use of these vehicles in international traffic.~~

Without prejudice to specific cases, Contracting States must not impose contradicting requirements for the use of vehicles in international traffic on their network.

Rules in addition to the UTP requirements may be imposed only in the form of national technical requirements in accordance with Article 12 of the APTU UR.

Contracting States may have additional or different accessibility requirements for vehicles used in domestic traffic only.

- (3) There are no mandatory provisions in this UTP for infrastructure, operational aspects, or telematics. Contracting States should however consider the interfaces between these subsystems and vehicles that comply with this UTP to facilitate PRM accessibility. ~~According to UTP-GEN-A¹, point 2.1. Infrastructure, COTIF includes infrastructure only to the extent related to interfaces with the vehicles and other movable railway material. The interfaces between the rolling stock subsystem and the infrastructure subsystem covered by this UTP are limited to the gap between the platform and the vehicle entrance. As a consequence, all other infrastructure and station-related provisions in this UTP are not mandatory.~~

~~The vehicle-related parameters in this UTP are mandatory for admissions according to ATMF of vehicles in the scope of this UTP.~~

- (4) The objectives and scope of COTIF and the EU law concerning railways are not identical and it has therefore been necessary to use different terminology for concepts that have a similar but not identical meaning. The following table lists the terms used in this UTP and the corresponding terms used in the PRM~~relevant~~ TSI:

¹ ~~Essential requirements—General Provisions, UTP-GEN-A~~

| | | | |
|---|--|--------------------|------------------|
|  OTIF | Uniform Technical Prescription | | UTP PRM |
| | Accessibility for persons with disabilities and persons with reduced mobility | | Page 4 of 112 |
| Status: PROPOSAL | | TECH-25004 Annex 1 | Original: EN |
| | | | Date: 24.02.2025 |

| This UTP | EU law |
|--|---|
| Uniform Technical Prescription (UTP) | Technical Specification of Interoperability (TSI) |
| The UTP verification procedure | The EC verification procedure |
| Assessing entity | Notified body |
| Assessment procedures for the verification of subsystems (modules) | EC verification of a subsystem (modules) |
| Contracting State | Member State |
| Type or design examination certificate | EC type or design examination certificate |

- (5) Where provisions in this UTP and the PRM TSI differ in substance, the respective texts are in a 2-column format. The left-hand column and the full width texts show the UTP provisions ~~(OTIF rules)~~ and the right-hand column shows the European Union TSI texts. [The list of specific cases in section 7.2 for Contracting States that are not members of the European Union are in full-width.](#)

Texts in the right-hand column are strictly for information only. For EU law, consult the Official Journal of the European Union.

Where differences between texts of this UTP and the European Union PRM TSI are either editorial, or not substantive, or concern the list of terms quoted above, the PRM TSI texts are not generally reproduced. The TSI texts may however be reproduced in some instances to improve clarity and readability.

1. INTRODUCTION

~~The objective of~~

~~this uniform technical prescription (UTP) is to enhance accessibility to international passenger rail transport for~~ [This UTP lays down harmonised accessibility requirements for passenger vehicles used in international traffic.](#)

[The objective of](#) this technical specification for interoperability (TSI) is to enhance the accessibility of rail transport to [persons with disabilities and persons with reduced mobility.](#)

| | | | |
|---|--|--------------------|------------------|
|  OTIF | Uniform Technical Prescription | | UTP PRM |
| | Accessibility for persons with disabilities and persons with reduced mobility | | Page 5 of 112 |
| Status: PROPOSAL | | TECH-25004 Annex 1 | Original: EN |
| | | | Date: 24.02.2025 |

~~persons with disabilities and persons with reduced mobility.~~

~~For this purpose, this UTP lays down harmonised requirements for accessibility for persons with disabilities and persons with reduced mobility applicable to vehicles used in international traffic.~~

~~Contracting States should not impose additional accessibility requirement on vehicles which are admitted to international traffic by another Contracting State in accordance with ATMF and which comply with this UTP, including specific cases defined in this UTP.~~

National technical requirements may be imposed only ~~if these are notified~~ in accordance with Article 12 of [the APTU UR](#).

1.1 Technical scope

~~The technical scope of this~~

~~This UTP shall apply to the rolling stock subsystem as defined in point 2 of UTP GEN-B² and in point 2.1.2 of this UTP.~~

~~The application of this UTP to the rolling stock subsystem is mandatory for passenger vehicles that are admitted to international traffic in accordance with the ATMF UR, taking into account the implementing rules in Chapter 7 of this UTP.~~

~~This UTP also concerns the infrastructure subsystem as defined in point 2.1.1 of this UTP.~~

~~The application of this UTP to the infrastructure subsystem is optional. Its application is recommended for the infrastructure subsystem, in particular to railway stations.~~

~~This UTP covers all aspects of these subsystems which are relevant to accessibility for persons with disabilities and persons with reduced mobility.~~

[The technical scope of this](#) TSI is defined in Article 2(1) of the Regulation.

1.2 Geographical scope

The geographical scope of this

² ~~Subsystems – General Provisions, UTP GEN-B 2017 as last amended on 1 June 2019~~

| | | | |
|---|--|--------------------|------------------|
|  OTIF | Uniform Technical Prescription | | UTP PRM |
| | Accessibility for persons with disabilities and persons with reduced mobility | | Page 6 of 112 |
| Status: PROPOSAL | | TECH-25004 Annex 1 | Original: EN |
| | | | Date: 24.02.2025 |

UTP ~~comprises all~~ is defined by the lines open to, or used for international traffic in accordance with the ATMF UR.

This UTP concerns passenger vehicles used in international traffic on these lines and stations along these lines that are used for boarding and alighting from these vehicles.

TSI is defined in Article 2(2) of the Regulation.

2. SCOPE OF SUBSYSTEMS AND DEFINITIONS

2.1 Scope of the subsystems

This UTP contains requirements for several of the subsystems described in UTP GEN-B, in particular infrastructure, rolling stock, operation, and telematics. The following points define the scope of this UTP in relation to these subsystems.

2.1.1 Scope related to Infrastructure subsystem

In accordance with UTP GEN-A point 2.1 and UTP GEN-B point 2.1, COTIF includes infrastructure only to the extent that it is related to interfaces with the vehicles.

The interfaces between the rolling stock subsystem and the infrastructure subsystem covered by this UTP PRM are limited to the gap between the platform and the vehicle entrance (Section 4.3.1 of this UTP PRM). The platform-related requirements concerning the gap are laid down in the UTP INF. The vehicle-related requirements concerning the gap are laid down in this UTP PRM.

Consequently, there are no mandatory requirements applicable to the Infrastructure subsystem in this UTP PRM.

The provisions in this UTP PRM concerning public areas within stations are optional. These provisions are included for reference and to enable their voluntary application. Their application may contribute to consistent approaches to accessibility in stations and is therefore recommended.

~~The application of the UTP to stations on international lines is not mandatory.~~

This TSI applies to all the public areas of stations dedicated to the transport of passengers that are controlled by the **R**ailway **U**ndertaking, **I**nfrastructure **M**anager or **S**tation **M**anager. This includes the provision of information, the purchase of a ticket and its validation if needed, and the possibility to wait for the train.

| | | | |
|---|--|--------------------|------------------|
|  OTIF | Uniform Technical Prescription | | UTP PRM |
| | Accessibility for persons with disabilities and persons with reduced mobility | | Page 7 of 112 |
| Status: PROPOSAL | | TECH-25004 Annex 1 | Original: EN |
| | | | Date: 24.02.2025 |

2.1.2 Scope related to **R**olling **S**tock subsystem

This UTP applies to **R**olling **S**tock which is in the scope of the UTP LOC&PAS and which is intended to carry passengers.

This UTP does not apply to rolling stock intended for other purposes than the carriage of persons. Persons accompanying a freight train or riding on other rail vehicles than those intended for passengers shall be subject to conditions set up by the railway undertaking

or by the competent authority.

~~This UTP shall apply to new rolling stock which is admitted to international operation after the date of entry into force of this UTP. This is without prejudice to point 7.1.2.~~

~~The UTP shall not apply to existing rolling stock, which is already used in international operation.~~

~~However, the UTP shall apply to existing rolling stock when it is subject to renewal or upgrading in accordance with Article 10§11 of ATMF⁴, having regard to chapter 7 of this UTP.~~

and published on its website.⁽³⁾

~~The TSI shall apply to all new infrastructure or rolling stock subsystems of the rail system in the Union, referred to in paragraph 1, which is placed in service after the date of application provided for in Article 12, account being taken of points 7.1.1 and 7.1.2 of the Annex.~~

~~The TSI shall not apply to existing infrastructure or rolling stock of the rail system in the Union, referred to in paragraph 1, which is already placed in service on the network (or part of it) of any Member State at the date of application provided for in Article 12.~~

~~However, the TSI shall apply to existing infrastructure and rolling stock of the rail system in the Union, referred to in paragraph 1, when it is subject to renewal or upgrading in accordance with Article 20 of Directive 2008/57/EC, having regard to Article 8 of this Regulation and point 7.2 of the Annex to this Regulation.~~

2.1.3 Scope related to operational aspects subsystem

~~The responsibilities for train composition and the safe use of vehicles are set out in the relevant UTP. The application of this UTP to other operational aspects as described in its section 4.4 is voluntary.~~

The operational procedures for the assistance of passengers with disabilities or with reduced mobility at stations and in trains are not in the scope of this UTP. However, these procedures should be

This TSI applies to the procedures enabling a coherent operation of the **I**nfrastructure and **R**olling **S**tock subsystems when passengers are persons with disabilities and persons with reduced mobility.

³—These provisions are set out in Article 2 of the Regulation enacting the PRM TSI.

⁴—**ATMF** means the Uniform Rules concerning Technical Admission of Railway Material used in International Traffic—Appendix G to COTIF 1999 in the version that entered into force on 1 March 2019.

| | | | |
|---|--|--------------------|------------------|
|  OTIF | Uniform Technical Prescription | | UTP PRM |
| | Accessibility for persons with disabilities and persons with reduced mobility | | Page 8 of 112 |
| Status: PROPOSAL | | TECH-25004 Annex 1 | Original: EN |
| | | | Date: 24.02.2025 |

[compatible with rolling stock that complies with the UTPs.](#)

2.1.4 Scope related to Telematics Applications for Passengers subsystem

This UTP applies to visual and audible passenger information systems located in stations and in

~~R~~olling ~~S~~tock.

Its application to [visual and audible information in](#) stations is voluntary.

2.2 Definition of “person with disabilities and person with reduced mobility”

“Person with disabilities and person with reduced mobility” means any person who has a permanent or temporary physical, mental, intellectual or sensory impairment which, in interaction with various barriers, may hinder their full and effective use of transport on an equal basis with other passengers or whose mobility when using transport is reduced due to age.

The transport of oversized items (for example: bicycles and bulky luggage) is not within the scope of this UTP.

2.3 Other definitions

Definitions related to rolling stock: refer to the UTP LOC&PAS point 2.2.

Accessibility data

Accessibility data consists of the information related to the accessibility of passenger railway stations that needs to be collected, maintained and exchanged, that is to say, of a description of the characteristics and equipment of the passenger railway stations. Where relevant that description is complemented by the information regarding the stations' state of conformity to this UTP.

Obstacle-free route

An obstacle-free route is a link between two or more public areas dedicated to the transport of passengers such as specified in point 2.1.1. It can be navigated by all persons with disabilities and reduced mobility. In order to achieve this, the route can be divided to better meet the needs of all persons with disabilities and reduced mobility. The combination of all the parts of the obstacle free route constitutes the route accessible for all persons with disabilities and reduced mobility.

Step-free route

A step-free route is a division of an obstacle-free route that meets the needs of mobility impaired persons. Changes in level are avoided or, when they cannot be avoided, they are bridged via ramps or lifts.

| | | | |
|---|--|--------------------|------------------|
|  OTIF | Uniform Technical Prescription | | UTP PRM |
| | Accessibility for persons with disabilities and persons with reduced mobility | | Page 9 of 112 |
| Status: PROPOSAL | | TECH-25004 Annex 1 | Original: EN |
| | | | Date: 24.02.2025 |

“Tactile Signs” and “Tactile Controls”

“Tactile signs” and “tactile controls” are signs or controls, which include raised pictograms, raised characters or Braille lettering.

Station Manager

The ~~S~~station ~~M~~anager is an organisational entity in a Contracting State, which has been made responsible for the management of a railway station and which may be the ~~I~~nfrastructure ~~M~~anager.

Safety Information

Safety information is information that shall be given to passengers so that they know in advance how they have to behave in case of an emergency.

Safety Instructions

Safety instructions are the instructions that shall be given to passengers in case of an emergency so that they understand what to do.

Level access

A level access is an access from a platform to the doorway of a rolling stock for which it can be demonstrated that:

- The gap between the door sill of that doorway (or of the extended bridging plate of that doorway) and the platform does not exceed 75 mm measured horizontally and 50 mm measured vertically and
- The rolling stock has no internal step between the door-sill and the vestibule.

“Interoperable wheelchair transportable by train”

An interoperable wheelchair transportable by train is a wheelchair the characteristics of which permit the full usage of all features of rolling stock designed for wheelchair users. The characteristics of an interoperable wheelchair transportable by train are within the limits specified in Appendix M.

3. ESSENTIAL REQUIREMENTS

The following tables indicate the essential requirements, as set out in

UTP GEN-A

Annex III of Directive [\(EU\) 2016/797](#)~~2008/57/EC~~ of the European Parliament and of the Council⁵,

that are met by the specifications set out in ~~Section~~[Chapter](#) 4 of this UTP for the scope of this UTP.

⁵ Directive [\(EU\) 2016/797](#)~~2008/57/EC~~ of the European Parliament and of the Council of ~~11 May 2016~~~~17 June 2008~~ on the interoperability of the rail system within the [European Union Community \(OJ L 191, 18.07.2008, p.1.\)](#)

| | | | |
|---|--|--------------------|------------------|
|  OTIF | Uniform Technical Prescription | | UTP PRM |
| | Accessibility for persons with disabilities and persons with reduced mobility | | Page 10 of 112 |
| Status: PROPOSAL | | TECH-25004 Annex 1 | Original: EN |
| | | | Date: 24.02.2025 |

The essential requirements that are not listed in the table are not relevant within the scope of this UTP.

Table 1: Essential requirements for the Infrastructure subsystem

| Infrastructure | | Reference to Essential Requirement in UTP GEN-A | | | | | |
|--|-----------------------------|---|------------------------------|--------|--------------------------|-------------------------|---------------|
| Element of the UTP Domain | Reference point of this UTP | Safety | Reliability and Availability | Health | Environmental protection | Technical compatibility | Accessibility |
| Parking facilities for persons with disabilities and persons with reduced mobility | 4.2.1.1 | | | | | | * |
| Obstacle-free route | 4.2.1.2 | * | | | | | * |
| Doors and entrances | 4.2.1.3 | 1.1.1 * | | | | | * |
| Floor surfaces | 4.2.1.4 | * | | | | | * |
| Highlighting of transparent obstacles | 4.2.1.5 | * | | | | | * |
| Toilets and baby-nappy changing facilities | 4.2.1.6 | 1.1.5 * | | | | | * |
| Furniture and free-standing devices | 4.2.1.7 | * | | | | | * |
| Ticketing, information desks and customer assistance points | 4.2.1.8 | * | 2.7.3 | | | 2.7.1 | * * |
| Lighting | 4.2.1.9 | * | | | | | * |
| Visual information: signposting, pictograms, printed or dynamic information | 4.2.1.10 | | | | | 2.7.1 | * * |
| Spoken information | 4.2.1.11 | * | 2.7.3 | | | 2.7.1 | * * |
| Platform width and edge of platform | 4.2.1.12 | * | | | | | * |
| End of platform | 4.2.1.13 | * | | | | | * |
| Boarding aids on platforms | 4.2.1.14 | 1.1.1 | | | | | * |
| Level track crossing at stations | 4.2.1.15 | * | | | | | * |

| | | | | |
|---|--|--------------------|----------------|------------------|
|  OTIF | Uniform Technical Prescription | | UTP PRM | |
| | Accessibility for persons with disabilities and persons with reduced mobility | | Page 11 of 112 | |
| Status: PROPOSAL | | TECH-25004 Annex 1 | Original: EN | Date: 24.02.2025 |

Cells in table 1 marked with an asterisk (*) have a corresponding Essential Requirement in EU law which does not exist in COTIF UTP GEN-A.

Table 2: Essential requirements for the ~~R~~olling ~~S~~tock subsystem

| Rolling S tock | | Reference to Essential Requirement in UTP GEN-A | | | | | |
|--|-----------------------------|---|------------------------------|--------|---------------------------|-------------------------|---------------|
| Element of the UTP Domain | Reference point of this UTP | Safety | Reliability and Availability | Health | Environ-mental protection | Technical compatibility | Accessibility |
| Seats | 4.2.2.1 | | | 1.3.1 | | | 2.4.5 |
| Wheelchair spaces | 4.2.2.2 | 2.4.1 | | | | | 2.4.5 |
| Doors | 4.2.2.3 | 1.1.1 1.1.5 2.4.1 | 1.2 | | | | 2.4.5 |
| Lighting | 4.2.2.4 | 2.4.1 | | | | | 2.4.5 |
| Toilets | 4.2.2.5 | 2.4.1 | | | | | 2.4.5 |
| Clearways | 4.2.2.6 | | | 1.3.1 | | | 2.4.5 |
| Customer information | 4.2.2.7 | 2.4.1 | 2.7.3 | | | 2.7.1 | 2.4.5 * |
| Height changes | 4.2.2.8 | 1.1.5 | | | | | 2.4.5 |
| Handrails | 4.2.2.9 | 1.1.5 | | | | | 2.4.5 |
| Wheelchair accessible sleeping accommodation | 4.2.2.10 | 2.4.1 | | | | | 2.4.5 |
| Step position for vehicle access and egress | 4.2.2.11 | 1.1.1 | 2.4.2 | | | 1.5 2.4.3 | 2.4.5 |
| Boarding aids | 4.2.2.12 | 1.1.1 | | | | 1.5 2.4.3 | 2.4.5 |

The cell in table 2 marked with an asterisk (*) has an ~~an~~ **additional** corresponding Essential Requirement in EU law, ~~which does not exist in COTIF~~ **In** UTP

| | | | |
|---|--|--------------------|------------------|
|  OTIF | Uniform Technical Prescription | | UTP PRM |
| | Accessibility for persons with disabilities and persons with reduced mobility | | Page 12 of 112 |
| Status: PROPOSAL | | TECH-25004 Annex 1 | Original: EN |
| | | | Date: 24.02.2025 |

GEN-A, [points 1.6.1 and 1.6.2, accessibility is covered as far as rolling stock is concerned. Accessibility with regard to operations and telematics is not an Essential Requirement in COTIF.](#)

4. CHARACTERISATION OF THE SUBSYSTEMS

4.1 Introduction

- (1) In accordance with Article 8 of the APTU [UR](#)⁶, UTPs apply to subsystems. Subsystems are defined in UTP GEN-B. The consistency between the different subsystems

The rail system of the Union, to which Directive [\(EU\) 2016/797](#)~~2008/57/EC~~ applies and of which the subsystems are parts, is an integrated system whose consistency

shall be verified. This consistency shall be checked in particular with regard to the specifications of each subsystem, its interfaces vis-à-vis the system in which it is integrated as well as the operating and maintenance rules.

- (2) The functional and technical specifications of the subsystems and their interfaces, described in points 4.2 and 4.3, do not impose the use of specific technologies or technical solutions, except where this is strictly necessary for the interoperability of

vehicles in international traffic.

the Union rail network.

But innovative solutions for interoperability may require new specifications and/or new assessment methods. In order to allow technological innovation, these specifications and assessment methods shall be developed

in a coordinated way, with the involvement of the Committee of Technical Experts.

by the process described in Article 6 of the Regulation.

Innovative solutions may be related to the rolling stock subsystem, its parts and its ICs.

⁽⁷⁾

The process to be followed for the application of innovative solutions for the rolling stock subsystem is defined in the UTP LOC&PAS.

1. *Technological progress may require innovative solutions, which do not comply with the specifications set out in the Annex or for which the assessment methods set out in the Annex cannot be applied.*

2. *Innovative solutions may concern the infrastructure and rolling stock subsystems, their parts and their interoperability constituents.*

3. *If an innovative solution is proposed, the manufacturer or his authorised*

⁶ ~~APTU means the Uniform Rules concerning the Validation of Technical Standards and the Adoption of Uniform Technical Prescriptions applicable to Railway Material intended to be used in International Traffic – Appendix F to COTIF 1999 in the version that entered into force on 1 March 2019.~~

⁷ These provisions are set out in Article 6 of the ~~Regulation enacting the~~ PRM TSI

| | | | |
|---|--|--------------------|------------------|
|  OTIF | Uniform Technical Prescription | | UTP PRM |
| | Accessibility for persons with disabilities and persons with reduced mobility | | Page 13 of 112 |
| Status: PROPOSAL | | TECH-25004 Annex 1 | Original: EN |
| | | | Date: 24.02.2025 |

representative established within the Union shall state how it deviates from the relevant provision of the TSI set out in the Annex and submit it to the Commission for analysis. The Commission may request the Agency's opinion on the proposed innovative solution and, where appropriate, may consult relevant stakeholders.

4. *The Commission shall deliver an opinion on the proposed innovative solution. If this opinion is positive, the appropriate functional and interface specifications and the assessment method needed in the TSI to enable use to be made of this innovative solution shall be developed and subsequently incorporated in the TSI during the revision process. If the opinion is negative, the innovative solution proposed cannot be applied.*
5. *Pending the revision of the TSI, the positive opinion delivered by the Commission shall be considered as acceptable means of compliance with the essential requirements of Directive 2008/57/EC and may be used for the assessment of subsystems and projects.*

- (3) Taking account of all the applicable essential requirements, the basic parameters related to accessibility for persons with disabilities and persons with reduced mobility are set out for the subsystems infrastructure and rolling stock in point 4.2 of this UTP. The operational requirements and responsibilities ~~are~~

~~for the assistance of passengers are deemed to be set regulated out at national level, in compliance with any applicable OTIF regulation and in accordance with the provision set out~~

~~in point 4.4 of this UTP.~~

are set out in the [Commission Implementing Regulation \(EU\) 2019/773⁸](#) (OPE TSI) and in [point 4.4 of this TSI](#).

4.2 Functional and technical specifications

4.2.1 Infrastructure Subsystem

- (1) [Application of all the provisions in point 4.2.1 and its sub-points is optional, despite the requirements being formulated as imperatives.](#)

⁸ [OPE TSI means Commission Implementing Regulation \(EU\) 2019/773 of 16 May 2019 on the technical specification for interoperability relating to the operation and traffic management subsystem of the rail system within the European Union and repealing Decision 2012/757/EU.](#)

| | | | |
|---|--|--------------------|------------------|
|  OTIF | Uniform Technical Prescription | | UTP PRM |
| | Accessibility for persons with disabilities and persons with reduced mobility | | Page 14 of 112 |
| Status: PROPOSAL | | TECH-25004 Annex 1 | Original: EN |
| | | | Date: 24.02.2025 |

(+) In light of the essential requirements in Section 3, the functional and technical specifications of the infrastructure subsystem related to accessibility for persons with disabilities and persons with reduced mobility are arranged as follows:

- Parking facilities for persons with disabilities and persons with reduced mobility
- Obstacle-free routes
- Doors and entrances
- Floor surfaces
- Highlighting of transparent obstacles
- Toilets and baby nappy changing facilities
- Furniture and free-standing devices
- Ticketing, information desks and customer assistance points
- Lighting
- Visual information: signposting, pictograms, printed or dynamic information
- Spoken information
- Platform width and edges of platforms
- End of platforms
- Boarding aids stored on platforms
- Level track crossings

(2) The basic parameters that are specified in points 4.2.1.1 – 4.2.1.15 apply to the scope of the infrastructure subsystem that is defined in point 2.1.1; they can be divided into two categories:

- Those for which technical details need to be specified, such as the parameters relative to the platforms and how to reach the platforms. In this first case, the basic parameters are specifically described and the technical details to be satisfied in order to fulfil the requirement are detailed.
- Those for which technical details are not necessary to be specified, such as the value of ramps or the characteristics of parking places. In this second case, the basic parameter is defined as a functional requirement that can be met by applying several technical solutions.

The table 3 below indicates the category of each of the basic parameters.

Table 3: Categories of basic parameters

| Basic Parameter | Technical details provided | Functional requirement only |
|--|---|------------------------------------|
| Parking facilities for persons with disabilities and persons with reduced mobility | | Complete point 4.2.1.1 |
| Obstacle-free route | Location of the routes Width of the obstacle-free route Threshold | Detailed characteristics |

| | | | |
|---|--|--------------------|------------------|
|  OTIF | Uniform Technical Prescription | | UTP PRM |
| | Accessibility for persons with disabilities and persons with reduced mobility | | Page 15 of 112 |
| Status: PROPOSAL | | TECH-25004 Annex 1 | Original: EN |
| | | | Date: 24.02.2025 |

| | | |
|---|---|---|
| | Double handrails Type of lift Height of braille signs | |
| Doors and entrances | 4.2.1.3 (2): Door width 4.2.1.3 (4): Height of door operating device | 4.2.1.3 (1) 4.2.1.3 (3) |
| Floor surfaces | 4.2.1.4 (2): Floor irregularities | Complete point 4.2.1.4 (1): Slip resistance |
| Highlighting of  transparent obstacles | | Complete point 4.2.1.5 |
| Toilets and baby nappy changing facilities | | Complete point 4.2.1.6 |
| Furniture and free-standing devices | | Complete point 4.2.1.7 |
| Ticketing, Information desks and Customer Assistance points | 4.2.1.8 (5): Passageway for ticket control machines | 4.2.1.8 (1) to (4) 4.2.1.8 (6) |
| Lighting | 4.2.1.9 (3): Lighting on platforms | 4.2.1.9 (1), 4.2.1.9 (2), 4.2.1.9 (4): Lighting in other locations |
| Visual information: signposting, pictograms, printed or dynamic information | Detail of information to be provided Location of information | Detailed characteristics of visual information |
| Spoken information | Complete point 4.2.1.11 | |
| Platform width and edge of platform | Complete point 4.2.1.12 (2) to (5) 4.2.1.12 (6) to (9): Presence of the items | 4.2.1.12 (1) 4.2.1.12 (6) to (9): Characteristics of contrast and of visual and tactile markings |
| End of platform | Complete point 4.2.1.13: Presence of the items | 4.2.1.13: Characteristics of contrast and of visual and tactile markings |
| Boarding aids stored on platforms | Complete point 4.2.1.14 | |
| Passenger track level crossing at stations | Complete point 4.2.1.15 | |

| | | | |
|---|--|--------------------|------------------|
|  OTIF | Uniform Technical Prescription | | UTP PRM |
| | Accessibility for persons with disabilities and persons with reduced mobility | | Page 16 of 112 |
| Status: PROPOSAL | | TECH-25004 Annex 1 | Original: EN |
| | | | Date: 24.02.2025 |

4.2.1.1 Parking facilities for persons with disabilities and persons with reduced mobility

- (1) Where a station specific parking area exists, there shall be sufficient and adapted parking spaces reserved for persons with disabilities and persons with reduced mobility eligible to utilise them at the nearest practicable position, within the parking area, to an accessible entrance.

4.2.1.2 Obstacle-free route

- (1) Obstacle free routes shall be provided that interconnect the following public areas of the infrastructure if provided:

- Stopping points for other connecting modes of transport within the station confines (for example, taxi, bus, tram, metro, ferry etc.);
- Car parks
- Accessible entrances and exits
- Information desks
- Visual and audible information systems
- Ticketing facilities
- Customer assistance
- Waiting areas
- Toilet facilities
- Platforms

- (2) ~~The length of the~~ All obstacle-free routes, footbridges and subways, shall have a free width of a minimum of 160 cm, except in areas that are specified in points 4.2.1.2.2 (3a) (ramps), 4.2.1.3 (2) (doors), 4.2.1.12 (3) (platforms) and 4.2.1.15 (2) (level crossings). ~~be the shortest practical distance.~~

- (3) Obstacle-free route floor surfaces and ground surfaces shall have low reflecting properties.

4.2.1.2.1 Horizontal circulation

- (1) ~~All obstacle-free routes, footbridges and subways, shall have a free width of a minimum of 160 cm except in areas that are specified in points 4.2.1.3 (2) (doors), 4.2.1.12 (3) (platforms) and 4.2.1.15 (2) (level crossings).~~

- (2) Where thresholds are installed on a horizontal route, they shall contrast with the surrounding floor and shall not be higher than 2.5 cm.

4.2.1.2.2 Vertical circulation

- (1) Where an obstacle-free route includes a change in level, there shall be a step-free route providing an alternative to stairs for mobility impaired people.

| | | | |
|---|--|--------------------|------------------|
|  OTIF | Uniform Technical Prescription | | UTP PRM |
| | Accessibility for persons with disabilities and persons with reduced mobility | | Page 17 of 112 |
| Status: PROPOSAL | | TECH-25004 Annex 1 | Original: EN |
| | | | Date: 24.02.2025 |

- (2) ~~Staircases~~ Steps and stairs on the obstacle-free routes shall have a minimum width of 160 cm measured between the handrails. ~~As a minimum the first and last steps shall be indicated by a contrasting band and as a minimum tactile warning surface indicators shall be installed before the first descending step.~~
- (2a) As a minimum, the first and last steps of a flight of stairs shall be indicated by a contrasting band. This requirement shall apply from a single step.
- (2b) As a minimum, tactile warning surface indicators shall be installed before the first descending step of staircases of three steps or more.
- (3) Ramps shall be installed for persons with disabilities and persons with reduced mobility unable to use stairs where lifts are not provided. They shall have a moderate gradient. A steep gradient is allowed for ramps on short distances only.
- (3a) When they are used as a complement to stairs, ramps may have a width of 120 cm measured at floor surface.
- (4) Stairs of three steps or more and ramps shall be provided with handrails on both sides and at two levels.
- (5) Lifts shall be provided where ramps are not available and shall be at least of type 2 in accordance with the specification referenced in Appendix A, index [1]. Type 1 lifts are allowed in the case of stations being renewed or upgraded only.
- (6) Escalators and moving walks shall be designed in accordance with the specification referenced in Appendix A, index [2].
- (7) Level track crossings can form part of an obstacle-free route when they comply with the requirements of point 4.2.1.15.

4.2.1.2.3 *Route identification*

- (1) Obstacle-free routes shall be clearly identified by visual information as detailed in point 4.2.1.10.
- (2) Information on the obstacle-free route shall be given to visually impaired people by a walking surface that has tactile and contrasting ~~walking surface~~ indicators as a minimum. This ~~paragraph point~~ does not apply to obstacle free routes to and from car parks.
- (2a) If more than one facility of a certain type of public area is provided, the route to at least one of them shall be indicated by tactile and contrasting walking surface indicators.
- (2b) Tactile walking surface indicators can be omitted when the route is indicated unambiguously by built or natural elements, such as edges and surfaces that can be followed tactually and visually.
- (3) Technical solutions using remotely controlled audible devices or telephone applications are permitted to be used in addition or as an alternative. When they are intended to be used as an alternative, they shall be treated as innovative solutions.
- (4) If there are handrails or walls within reach along the obstacle-free route to the platform, they shall have brief information (for example platform-number or direction-information). The information shall be in

| | | | |
|---|--|--------------------|------------------|
|  OTIF | Uniform Technical Prescription | | UTP PRM |
| | Accessibility for persons with disabilities and persons with reduced mobility | | Page 18 of 112 |
| Status: PROPOSAL | | TECH-25004 Annex 1 | Original: EN |
| | | | Date: 24.02.2025 |

Braille or ~~in~~-prismatic-letters or numbers. [The information shall be located](#) on the handrail, or on the wall at a height between 145 cm and 165 cm.

4.2.1.3 Doors and entrances

- (1) This point applies to all doors and entrances that are on obstacle-free routes, with the exception of doors giving access to the toilets which are not dedicated to persons with disabilities and persons with reduced mobility.
- (2) Doors shall have a minimum clear useable width of 90 cm and shall be operable by persons with disabilities and persons with reduced mobility.
- (3) It is permitted to use manual, semi-automatic or automatic doors.
- (4) Door operating devices shall be available at a height of between 80 cm and 110 cm.

4.2.1.4 Floor surfaces

- (1) All floor coverings, ground surfaces and stair tread surfaces shall be slip resistant.
- (2) Within the station buildings there shall be no irregularities in excess of 0.5 cm at any given point in floor walking surface areas, except for thresholds, drainage channels and tactile walking surface indicators.

4.2.1.5 Highlighting of Transparent obstacles

- (1) Transparent obstacles on or along the routes used by passengers, consisting of glass doors or transparent walls, shall be marked. These markings shall highlight the transparent obstacles. They are not required if passengers are protected from impact by other means – for example, by handrails or continuous benches.

4.2.1.6 Toilets and baby nappy changing facilities

- (1) If toilets are provided at a station, then a minimum of one unisex cubicle shall be wheelchair accessible.
- (2) If ~~toilets are provided at a station,~~ baby nappy changing facilities [are provided at a station, then a minimum of one baby nappy changing facility](#) shall be ~~provided which are~~ accessible to both men and women [wheelchair users](#).

4.2.1.7 Furniture and free-standing devices

- (1) All items of furniture and free-standing devices at stations shall contrast with their background, and have rounded edges.
- (2) Within the station confines, furniture and free-standing devices (including cantilevered and suspended items) shall be positioned where they do not obstruct blind or visually impaired people, or they shall be detectable by a person using a long cane.
- (3) On each platform where passengers are allowed to wait for trains, and at every waiting area, there shall be a minimum of one area fitted with seating facilities and a space for a wheelchair.

| | | | |
|---|--|--------------------|------------------|
|  OTIF | Uniform Technical Prescription | | UTP PRM |
| | Accessibility for persons with disabilities and persons with reduced mobility | | Page 19 of 112 |
| Status: PROPOSAL | | TECH-25004 Annex 1 | Original: EN |
| | | | Date: 24.02.2025 |

(4) When this area is weather protected, it shall be accessible by a wheelchair user.

4.2.1.8 Ticketing, Information desks and Customer Assistance points

- (1) Where manual ticket sales counters, information desks and customer assistance points are provided ~~along the obstacle free route~~, a minimum of one desk shall be accessible to a wheelchair user and to people of small stature and a minimum of one desk shall be fitted with an induction loop system for hearing assistance.
- (2) If there is a glass barrier between the passenger and sales person at the ticket counter, this shall either be removable or, if not removable, an intercom system shall be fitted. Any such glass barrier shall consist of clear glass.
- (3) If electronic devices are fitted that displays pricing information to the sales person, such devices shall also be fitted that display the price to the person purchasing the ticket.
- (4) Where ticket vending machines are provided ~~on an obstacle free route~~ at a station, a minimum of one of these machines shall have an interface that is reachable by a wheelchair user and people of small stature. [This requirement applies to each ticket vendor providing vending machines in the station.](#)
- (5) If ticket control machines are fitted, a minimum of one of the machines shall have a free passageway with a minimum width of 90 cm and shall be able to accommodate an occupied wheelchair up to 1250 mm in length. In the case of upgrade or renewal, a minimum width of 80 cm is permitted.
- (6) If turnstiles are used, there shall be a non-turnstile access point available for use by persons with disabilities and persons with reduced mobility at all operational times.

4.2.1.9 Lighting

- (1) The illuminance level of the external areas of the station shall be sufficient to facilitate way finding and to highlight the changes of level, doors and entrances.
- (2) The illuminance level along obstacle-free routes shall be adapted to the visual task of the passenger. Particular attention shall be paid to the changes of levels, ticket vending offices and machines, information desks and information displays.
- (3) The platforms shall be illuminated [in accordance with](#) the specification referenced in Appendix A, [Index \[3\]](#) and [Index \[4\]](#).
- (4) Emergency lighting shall provide sufficient visibility for evacuation and for identification of fire-fighting and safety equipment.

4.2.1.10 Visual information: signposting, pictograms, printed or dynamic information

- (1) The following information shall be provided:
 - Safety Information and Safety Instructions.
 - Warning, prohibition and mandatory actions signs.
 - Information concerning the departure of trains.

| | | | |
|---|--|--------------------|------------------|
|  OTIF | Uniform Technical Prescription | | UTP PRM |
| | Accessibility for persons with disabilities and persons with reduced mobility | | Page 20 of 112 |
| Status: PROPOSAL | | TECH-25004 Annex 1 | Original: EN |
| | | | Date: 24.02.2025 |

- Identification of station facilities, where provided, and access routes to those facilities.
- (2) The fonts, symbols and pictograms used for visual information shall contrast with their background.
 - (3) Signposting shall be provided at all points where passengers need to make a route taking decision and at intervals on the route. Signage, symbols and pictograms shall be applied consistently over the whole route.
 - (4) The information concerning the departure of trains (including destination, intermediate stops, platform number and time) shall be available and suitable for reading from at a height of 160 cm ~~maximum~~ at least in one location in the station. ~~This requirement applies to printed and dynamic information whatever is provided.~~
 - (5) The typeface used for texts shall be easily readable.
 - (6) All safety, warning, mandatory action and prohibition signs shall include pictograms.
 - (7) Tactile information signage shall be fitted in:
 - Toilets, for functional information and call for aid if appropriate.
 - Lifts in accordance with the specification referenced in Appendix A, index [1].
 - (8) Time information presented in digits shall be in the 24h system.
 - (9) The following specific graphic symbols and pictograms shall be fitted with the wheelchair symbol in accordance with ~~a~~Appendix N:
 - Directional information for wheelchair specific routes.
 - Indication of the wheelchair accessible toilets and other amenities if provided.
 - If there is train configuration information on the platform, indication of the wheelchair boarding location.

The symbols are permitted to be combined with other symbols (for example: lift, toilet, etc.).
 - (10) Where inductive loops are fitted, these shall be indicated by a sign as described in ~~a~~Appendix N.
 - (11) In wheelchair accessible toilets, where hinged handrails are provided, a graphic symbol showing the rail in both the stowed and deployed position shall be provided.
 - (12) There shall be no more than five pictograms, in addition to~~together with~~ a directional arrow, indicating a single direction placed adjacent to each other at a single location.
 - (13) Displays shall be sized to show individual station names (which may be abbreviated) or words of messages. Each station name, or words of messages, shall be displayed for a minimum of 2 seconds. ~~compliant to the requirements of point 5.3.1.1. In this point, t~~The term “display” shall be understood as any support of dynamic information.
 - (14) If a scrolling display is used (either horizontal or vertical), each complete word shall be displayed for a minimum of 2 seconds and the horizontal scrolling speed shall not exceed 6 characters per second.
 - (15) Displays shall be designed for a maximum viewing distance in accordance with the following formula:

| | | | |
|---|--|--------------------|------------------|
|  OTIF | Uniform Technical Prescription | | UTP PRM |
| | Accessibility for persons with disabilities and persons with reduced mobility | | Page 21 of 112 |
| Status: PROPOSAL | | TECH-25004 Annex 1 | Original: EN |
| | | | Date: 24.02.2025 |

[Reading distance in mm divided by 250 = character height \(for example: 10 000 mm/250 = 40 mm\).](#)

4.2.1.11 Spoken information

- (1) The spoken information shall have a minimum STI-PA level of 0.45, in accordance with the specification referenced in Appendix A, index [5].

4.2.1.12 Platform width and edge of platform

- (1) The danger area of a platform commences at the rail side edge of the platform and is defined as the area where passengers are not allowed to stand when trains are passing or arriving.
- (2) It is permitted for the width of the platform to be variable on the whole length of the platform.
- (3) The minimum width of the platform without obstacles shall be the width of the danger area plus the width of two opposing freeways of 80 cm (160 cm). This dimension may taper to 90 cm at the platform ends.
- (4) It is permitted to have obstacles inside this freeway of 160 cm. Equipment required for the signalling system and safety equipment shall not be considered as obstacles in this point. The minimum distance from obstacles to the danger area shall be according to the following table:

Table 4: Minimum distance from obstacles to the danger area

| Length of obstacles (measured parallel to the platform edge) | Minimum distance to the danger area |
|---|-------------------------------------|
| < 1 m (note 1) – small obstacle | 80 cm |
| 1 m to < 1 m – large obstacle | 120 cm |

Note 1: if the distance between two small obstacles is less than 2.4m measured parallel to the platform edge they shall be considered as one large obstacle.

Note 2: Within this minimum distance from a large obstacle to the danger area it is permitted to have additional small obstacles as long as the requirements for small obstacles (minimum distance to danger area and minimum distance to next small obstacle) are met.

-
- (5) ~~[Reserved] If there are auxiliary facilities on board trains, or on the platform, to allow wheelchair users to board on or alight from trains, a free space (no obstacles) of 150 cm from the edge of the facility towards the direction where the wheelchair boards/lands at to the platform level, shall be provided where such facilities are likely to be used. A new station shall meet this requirement for all trains that are planned to stop at the platform.~~
 - (6) The boundary of the danger area, furthest from the rail side edge of the platform, shall have a visual marking and tactile walking surface indicators.
 - (7) The visual marking shall be a contrasting, slip resistant, warning line with a minimum width of 10 cm.

| | | | |
|---|--|--------------------|------------------|
|  OTIF | Uniform Technical Prescription | | UTP PRM |
| | Accessibility for persons with disabilities and persons with reduced mobility | | Page 22 of 112 |
| Status: PROPOSAL | | TECH-25004 Annex 1 | Original: EN |
| | | | Date: 24.02.2025 |

- (8) Tactile walking surface indicators can be one of the two types:
- an attention pattern indicating a hazard at the boundary of the danger area
 - a guiding pattern indicating a path of travel at the safe side of the platform
- (9) The material at the rail side edge of the platform shall contrast with the darkness of the gap.

4.2.1.13 End of platform

- (1) The end of the platform shall either be fitted with a barrier that prevents public access or shall have a visual marking and tactile walking surface indicators with an attention pattern indicating a hazard.

4.2.1.14 Boarding aids stored on platforms

- (1) If a platform ramp is used, it shall comply with the requirements of point 5.3.1.2.
- (2) If a platform lift is used, it shall comply with the requirements of point 5.3.1.3.
- (3) A secure storage method shall be provided to ensure that boarding aids, including portable ramps, when stored on a platform, do not cause an obstruction or pose any hazard to passengers.

4.2.1.15 Passenger track crossing to platforms

- (1) Level track crossings ~~in stations~~ are permitted to be used as part of a step-free route or of an obstacle-free route ~~according to National Rules~~.
- (2) If level track crossings are used as parts of step free routes in addition to other routes, they shall:
- have a minimum width of 120 cm (less than 10 m in length) or 160 cm (10 m or more in length)
 - have moderate slopes; a steep gradient is only allowed for ramps on short distances
 - be designed so that the smallest wheel of a wheelchair, as defined in [Appendix M](#), cannot be trapped within the crossing surface and the rail
 - where accesses to level crossings are equipped with safety chicanes in order to prevent people from unintended/uncontrolled crossing of the tracks, the minimum width of the walkways in the straight line and in the chicane can be less than 120 cm with a minimum of 90 cm; it shall be sufficient for a wheelchair user to manoeuvre.
- (3) If level track crossings are used as parts of obstacles free routes, unique solution for all passengers, they shall
- meet all specifications above
 - have visual and tactile markings to identify the beginning and the end of the crossing surface
 - be supervised, or, on the basis of national rules, equipment for a safe crossing of blind or visually impaired people shall be provided and/or the level crossing shall be operated for a safe crossing of visually impaired people
- (4) If any of the above requirements cannot be met, the level track crossing shall not be considered part of a step-free route or of an obstacle-free route.

| | | | |
|---|--|--------------------|------------------|
|  OTIF | Uniform Technical Prescription | | UTP PRM |
| | Accessibility for persons with disabilities and persons with reduced mobility | | Page 23 of 112 |
| Status: PROPOSAL | | TECH-25004 Annex 1 | Original: EN |
| | | | Date: 24.02.2025 |

4.2.2 Rolling Stock Subsystem

(1) In light of the essential requirements in Section 3, the functional and technical specifications of the subsystem **R**olling **S**tock related to accessibility for persons with disabilities and persons with reduced mobility are arranged as follows:

- Seats
- Wheelchair spaces
- Doors
- Lighting
- Toilets
- Clearways
- Customer information
- Height changes
- Handrails
- Wheelchair accessible sleeping accommodation
- Step position for vehicle access and egress

4.2.2.1 Seats

4.2.2.1.1 General

(1) Handholds or vertical handrails or other items that can be used for personal stability, whilst using the aisle, shall be provided on all aisle-side seats unless the seat, when in the upright position, is within 200 mm of:

- the back of another seat facing in the opposite direction which is fitted [at its aisle side](#) with a handhold or a vertical handrail or other items that can be used for personal stability
- a handrail or a partition [provided at the aisle side of the seat](#).

(2) Handholds or other items that can be used for personal stability shall be positioned at a height of between 800 mm and 1200 mm above the floor, measured from the centre of the usable part of the handhold, shall not protrude into the clearway and shall contrast with the seat.

(3) In seating areas with fixed longitudinal seats, handrails shall be used for personal stability. These handrails shall be at a maximum distance of 2000 mm apart, shall be positioned at a height of between 800 mm and 1200 mm above the floor and shall contrast with the vehicle interior surroundings.

(4) The handholds or other items shall not have sharp edges.

4.2.2.1.2 Priority seats

4.2.2.1.2.1 General

(1) Not less than 10 percent of the seats by fixed trainset or individual vehicle, and by class shall be designated as priority seats for the use of persons with disabilities and persons with reduced mobility.

| | | | |
|---|--|--------------------|------------------|
|  OTIF | Uniform Technical Prescription | | UTP PRM |
| | Accessibility for persons with disabilities and persons with reduced mobility | | Page 24 of 112 |
| Status: PROPOSAL | | TECH-25004 Annex 1 | Original: EN |
| | | | Date: 24.02.2025 |

- (2) The priority seats and vehicles containing them shall be identified by signs complying with ~~Appendix N~~. It shall be stated that other passengers shall make such seats available to those who are eligible to use them when required. Such identification is not required for units intended to be operated exclusively within a seat reservation system: this shall be reported in the technical documentation referred to in point 4.2.12 of the UTP LOC&PAS.
- (3) The priority seats shall be located within the passenger saloon and in close proximity to external doors. In double deck vehicles or trainsets, priority seats can be present on both decks.
- (4) The level of equipment fitted to the priority seats shall, as a minimum, be the same as that fitted to general seats of the same type.
- (5) When seats of a certain type are fitted with armrests, priority seats of the same type shall be fitted with movable armrests, this excludes armrests placed along the vehicle body side or along a partition wall in case of compartments. The movable armrest shall move into a position in line with the seat back cushion to enable unrestricted access to the seat or to any adjacent priority seats.
- (6) Priority seats shall not be tip-up seats.
- (7) Each priority seat and the space available to its user shall comply with the specification referenced in Appendix A, Index [16] ~~figures H1 to H4 from Appendix H.~~
- (8) The whole useful sitting surface of the priority seat shall be a minimum of 450 mm wide (see specification referenced in Appendix A, Index [16] ~~figure H1~~).
- (9) The top of each priority seat cushion shall be between 430 and 500 mm above floor level at the front edge of the seat.
- (10) The clear headroom above each seat shall be at least 1680 mm from floor level, except on double-decker trains on which luggage racks are provided above the seats. In such case reduced headroom of 1520 mm is permitted for priority seats underneath the luggage racks, provided that at least 50 % of priority seats maintain headroom of 1680 mm.
- (11) Where reclining seats are fitted, the dimensions shall be measured when the seats are in their fully upright position.

4.2.2.1.2.2 *Uni-directional seats*

- (1) Where uni-directional priority seats are provided, the clearance in front of each seat shall comply with the specification referenced in Appendix A, Index [16] ~~figure H2~~.
- (2) The distance between the front surface of the seat back and the vertical plane through the rearmost part of the seat in front shall be a minimum of 680 mm, noting that the required seat pitch shall be measured from the centre of the seat 70 mm above where the cushion meets the back support.
- (3) There shall also be a clear space between the front edge of the seat cushion and the same vertical plane for the seat in front of a minimum of 230 mm.

| | | | |
|---|--|--------------------|------------------|
|  OTIF | Uniform Technical Prescription | | UTP PRM |
| | Accessibility for persons with disabilities and persons with reduced mobility | | Page 25 of 112 |
| Status: PROPOSAL | | TECH-25004 Annex 1 | Original: EN |
| | | | Date: 24.02.2025 |

4.2.2.1.2.3 Facing seats arrangement

- (1) Where facing priority seats are provided, the distance between the front edges of the seat cushions shall be a minimum of 600 mm (See [the specification referenced in Appendix A, Index \[16\] figure H3](#)). Such distance shall be maintained even if one of the facing seats is not a priority seat.
- (2) Where facing priority seats are equipped with a table, there shall be a minimum clear horizontal distance between the front edge of the seat cushion and the leading edge of the table of at least 230 mm (See [the specification referenced in Appendix A, Index \[16\] figure H4](#)). When one of the facing seats is not a priority seat, its distance to the table can be reduced provided that the distance between the front edges of the seat cushions remains 600 mm. Sidewall mounted tables ~~the which~~-length ~~of which~~ does not extend over the centre line of the window seat do not need to be considered for conformity with this ~~paragraph~~[point](#).

4.2.2.2 Wheelchair spaces

- (1) According to the length of the unit, excluding the locomotive or power head, there shall be in that unit not less than the number of accessible wheelchair spaces shown in the following table:

Table 5: Minimum number of wheelchair spaces per unit length

| Unit length | Number of wheelchair spaces by unit |
|-----------------------------|-------------------------------------|
| Less than 30 m | 1 wheelchair space |
| 30 to 205 metres | 2 wheelchair spaces |
| More than 205 to 300 metres | 3 wheelchair spaces |
| More than 300 metres | 4 wheelchair spaces |

- (2) To ensure stability, the wheelchair space shall be designed for the wheelchair to be positioned either facing or back to the direction of travel.
- (3) Over the full length of the wheelchair space the width shall be 700 mm from floor level to a minimum height of 1450 mm with an additional 50 mm width to give clearance for hands on each side that is adjacent to any obstacle that will inhibit clearance for the wheelchair users hands (e.g. wall or structure) from a height of 400 mm to 800 mm above floor level (if one side of the wheelchair is adjacent to the aisle there is no additional 50 mm requirement for that side of the wheelchair as it is already free space)
- (4) The minimum distance in the longitudinal plane between the back of the wheelchair space and the next surface shall be in accordance with [the specification referenced in Appendix A, Index \[16\] Appendix I, figures I1 to I3](#).
- (5) There shall be no obstruction of the designated space between the floor and the ceiling of the vehicle other than an overhead luggage rack, a horizontal handrail in accordance with the requirements of point 4.2.2.9 attached to the wall or ceiling of the vehicle, or a table.

| | | | |
|---|--|--------------------|------------------|
|  OTIF | Uniform Technical Prescription | | UTP PRM |
| | Accessibility for persons with disabilities and persons with reduced mobility | | Page 26 of 112 |
| Status: PROPOSAL | | TECH-25004 Annex 1 | Original: EN |
| | | | Date: 24.02.2025 |

- (6) The back of the wheelchair space shall be a structure or other acceptable fitting of at least 700 mm wide. The height of the structure, or fitting, shall be capable of preventing a wheelchair that has been positioned with its back against the structure or fitting, from tipping over backwards.
- (7) Tip-up seats may be installed in the wheelchair space but, when in the stowed position, shall not encroach on the dimensional requirements of the wheelchair space.
- (8) ~~It is not allowed to install any permanent~~ There shall be no equipment such as bicycle hooks or ski racks ~~into~~ the wheelchair space or directly in front of it.
- (9) At least one seat shall be available either side-by-side with or adjacent to or facing to each of the wheelchair spaces for a companion to travel with the wheelchair user. This seat shall offer the same level of comfort as the other passenger seats, and may also be situated on the opposing side of the aisle.
- (10) On trains with a design speed higher than 250 km/h excepting double deck trains, it shall be possible for a wheelchair user occupying a wheelchair space to transfer onto a passenger seat that shall be equipped with a movable armrest. Such transfer is made by the wheelchair user in autonomy. In that case, it is allowed that the companion seat is shifted to another row. This requirement is applicable up to the number of wheelchair spaces per unit specified in table 5.
- (11) The wheelchair space shall be fitted with a call for aid device that shall, in the event of danger, provide to a wheelchair user the possibility to inform a person who can take appropriate action.
- (12) The call for aid device shall be placed within the comfortable reach range of the person using the wheelchair as shown in the specification referenced in Appendix A, Index [9] ~~Appendix L, figure L1.~~
- (13) The call for aid device shall not be placed within a narrow recess which prevents immediate intentional palm operation but can be protected from unintentional use.
- (14) The interface of the call for aid device shall be as ~~defined~~ set out in point 5.3.2.6.
- (15) A sign conforming to ~~a~~ Appendix N shall be placed immediately next to, or in the wheelchair space so as to identify the space as the wheelchair space.

4.2.2.3 Doors

4.2.2.3.1 General

- (1) These requirements apply only to doors providing access to another public part of the train, with the exclusion of toilet doors.
- (2) To latch or unlatch a manually operated door, for use by the public, the control device shall be operable by the palm of the hand exerting a force not exceeding 20 N.
- (3) Door controls, whether manual, pushbuttons or other devices, shall contrast with the surface on which they are mounted.
- (4) Their interface with passengers shall comply with the specifications of point 5.3.2.1.
- (5) If both open and closed door control devices are fitted one above the other, the top device shall always be the open control.

| | | | |
|---|--|--------------------|------------------|
|  OTIF | Uniform Technical Prescription | | UTP PRM |
| | Accessibility for persons with disabilities and persons with reduced mobility | | Page 27 of 112 |
| Status: PROPOSAL | | TECH-25004 Annex 1 | Original: EN |
| | | | Date: 24.02.2025 |

4.2.2.3.2 Exterior doors

- (1) All exterior passenger doorways shall have a minimum clear useable width of 800 mm when open.
- (2) On trains with a design speed lower than 250 km/h, wheelchair access doors offering a level access as defined in point 2.3 shall have a minimum clear useable width of 1000 mm when open.
- (3) All exterior passenger doorways shall be marked on the outside in a way that gives a contrast to the vehicle body-side surrounding them.
- (4) The designated wheelchair exterior accessible doorways shall be the closest doorways to the designated wheelchair spaces.
- (5) The doors to be used for wheelchair access shall be clearly labelled with a sign in accordance with ~~a~~Appendix N.
- (6) From the inside of the vehicle the position of external doorways shall clearly be marked by use of contrasted adjacent flooring.
- (7) Audible and visible signals shall be given to persons inside and outside the train when doors are operated or about to operate. ~~When a door is released for opening a signal shall be given that is clearly audible and visible to persons inside and outside the train. This alert signal shall last for a minimum of five seconds unless the door is operated, in which case it may cease after 3 seconds.~~
- (8) The door operating signals are the following:
 - when a door is released for opening, a door opening signal shall be given; it shall last a minimum of 5 seconds unless the door is operated, in which case it may cease after 3 seconds;
 - ~~w~~When a door is automatically or remotely opened by the driver or other member of the train crew, a door opening~~the alert~~ signal shall be given; it shall last for a minimum of 3 seconds from the moment that the door starts to open;
 - when a door that is automatically or remotely closed is about to operate, a door closing signal shall be given; it shall start a minimum of 2 seconds before the door starts to close and shall continue until the door is closed;
 - when a door is closed locally (by a passenger or crew), a door closing signal shall be given; it shall start following the operation of the control device and shall continue until the door is closed.

The audible and visible door closing signal can be omitted when a door is closing for reasons other than departure if alternative means are in place to mitigate the risk of injury to the passengers and the train crew. The provision of audible and visible door closing signals or of the alternative means shall be equally accepted in all Contracting States.
- (9) The audible door opening signal for persons outside the train can be omitted when a door finding signal is provided. A door finding signal shall sound continuously whilst the door is released or available to be opened, or both. ~~When a door that is automatically or remotely closed, is about to operate, an audible and visible alert signal shall be given to persons inside and outside the train. The alert signal shall start a minimum of 2 seconds before the door starts to close and shall continue while the door is closing.~~
- (10) The sound source for door ~~alert~~ signals shall be ~~located~~ in the area local to the control device.

| | | | |
|---|--|--------------------|------------------|
|  OTIF | Uniform Technical Prescription | | UTP PRM |
| | Accessibility for persons with disabilities and persons with reduced mobility | | Page 28 of 112 |
| Status: PROPOSAL | | TECH-25004 Annex 1 | Original: EN |
| | | | Date: 24.02.2025 |

~~or, if~~ If there is no ~~such~~ control device, the sound source for door signals shall be located adjacent to the doorway.

If a separate sound source is used for the door closing signal, it can be either local to the control device or adjacent to the doorway.

If an external door finding signal is provided, its sound source shall be located in the area local to the control device, and the sound source for the door closing signal shall be located in the area adjacent to the doorway.

- (11) The visible signals shall be visible from inside and outside the train and shall be located such that ~~they~~ minimises the opportunity for ~~them~~ to be obscured by passengers located in the vestibule. Visible signals shall be in accordance with the specification referenced in Appendix A, Index [19].
- (12) Passenger doors audible ~~alert~~ signals shall be in accordance with the specification in Appendix G.
- (13) The method of door activation shall be by train crew, semi-automatic (~~i.e. for instance,~~ passenger pushbutton operation) or automatic.
- (14) The door control shall be located either next to or on the door leaf.
- (15) The centre of exterior door opening control, operable from the platform, shall be not less than 800 mm and not more than 1200 mm measured vertically above platforms, for all platforms for which the train is designed. If the train is designed for a single platform height, the centre of exterior door opening control shall be not less than 800 mm and not more than 1100 mm measured vertically above that platform height.
- (16) The centre of internal door opening control for the exterior door shall be not less than 800 mm and not more than 1100 mm measured vertically above the vehicle floor level.

4.2.2.3.3 Interior doors

- (1) Internal automatic and semi-automatic doors shall incorporate devices that prevent passengers becoming trapped during operation of the doors.
- (2) Interior doors that are made available for wheelchair users shall have a minimum clear ~~useable~~ width of 800 mm.
- (3) The force required to open or close a manual door shall not exceed 60 N.
- (4) The centre of interior door controls shall be not less than 800 mm and not more than 1100 mm measured vertically above the vehicle floor level.
- (5) Automatic inter-vehicle connecting doors shall operate either synchronously as a pair, or the second door shall automatically detect the person moving towards it and open.
- (6) If more than 75 % of a door's surface is made of a transparent material, it shall be clearly marked with visual indicators.

| | | | |
|---|--|--------------------|------------------|
|  OTIF | Uniform Technical Prescription | | UTP PRM |
| | Accessibility for persons with disabilities and persons with reduced mobility | | Page 29 of 112 |
| Status: PROPOSAL | | TECH-25004 Annex 1 | Original: EN |
| | | | Date: 24.02.2025 |

4.2.2.4 Lighting

- (1) Minimum values of average illuminance in the passenger areas shall be in accordance with the specification referenced in Appendix A, Index [6]. Requirements relative to the uniformity of these values are not applicable for conformity with this UTP.

4.2.2.5 Toilets

- (1) When toilets are fitted in a train, a universal toilet shall be provided accessible from the wheelchair space.
- (2) The standard toilet shall be compliant with the requirements of points 5.3.2.2 and 5.3.2.3.
- (3) The universal toilet shall be compliant with the requirements of points 5.3.2.2 and 5.3.2.4.
- (4) When toilets are fitted in a train a baby nappy changing facility shall be provided. If separate nursery facilities are not provided or if separate nursery facilities are provided but are not accessible to a wheelchair user, a table shall be incorporated within the universal toilets. It shall be compliant with the requirements of point 5.3.2.5.

4.2.2.6 Clearways

- (1) From the vehicle entrance, the following section of the clearway shall be in accordance with the specification referenced in Appendix A, Index [17] ~~as follows:~~
 - through the vehicles ~~according to figure J1 of Appendix J,~~
 - between connecting vehicles of a single trainset, ~~according to figure J2 of Appendix J,~~
 - to and from wheelchair accessible doors, wheelchair spaces and wheelchair accessible areas including sleeping accommodation and universal toilets if provided, ~~according to figure J3 of Appendix J.~~
- (2) The minimum height requirement does not need to be verified in:
 - all areas of double-deck vehicles,
 - gangways and door areas of single deck vehicles.

In those areas, reduced headroom is accepted as a consequence of structural constraints (gauge, physical space).

- (3) A turning space, with a minimum diameter of 1500 mm, shall be provided adjacent to the wheelchair space and in other locations where wheelchairs are supposed to turn 180°. The wheelchair space may be part of the turning circle.
- (4) If a change in direction is required for a wheelchair user, the clearway width of both corridors or corridor and door shall be in accordance with the specification referenced in Appendix A, Index [17]. ~~to table K1 of Appendix K.~~

| | | | |
|---|--|--------------------|------------------|
|  OTIF | Uniform Technical Prescription | | UTP PRM |
| | Accessibility for persons with disabilities and persons with reduced mobility | | Page 30 of 112 |
| Status: PROPOSAL | | TECH-25004 Annex 1 | Original: EN |
| | | | Date: 24.02.2025 |

4.2.2.7 Customer Information

4.2.2.7.1 General

- (1) The following information shall be provided:
 - Safety Information and Safety Instructions
 - Audible safety instructions coupled with visible signals in case of emergency
 - Warning, prohibition and mandatory actions signs
 - Information concerning the route of the train, including information about delays and unplanned stops,
 - Information concerning the location of on-board facilities
- (2) Visual information [referred to in point \(1\)](#) shall contrast with its background.
- (3) The typeface used for texts [referred to in point \(1\)](#) shall be easily readable.
- (4) Time information presented in digits shall be in the 24h system

4.2.2.7.2 Signage, pictograms and tactile information

- (1) All safety, warning, mandatory action and prohibition signs shall include pictograms and shall be designed according to the specification referenced in Appendix A, index [7].
- (2) There shall be no more than five pictograms, [in addition to](#)~~together with~~ a directional arrow, indicating a single direction placed adjacent to each other at a single location.
- (3) The following specific pictograms shall be fitted with the wheelchair symbol in accordance with [Appendix N](#):
 - Directional information for wheelchair accessible amenities
 - Indication of the wheelchair accessible door location outside the train
 - Indication of the wheelchair space inside the train
 - Indication of the universal toilets

The symbols can be combined with other symbols (for example: carriage number, toilet, etc.).

- (4) Where inductive loops are fitted these shall be indicated by a pictogram complying with [Appendix N](#).
- (5) In universal toilets, where hinged handrails are provided, a pictogram showing the rail in both the stowed and deployed positions shall be provided.
- (6) If a vehicle provides reserved seats then the number or letter of that vehicle (as used in the reservation system) shall be displayed externally on or adjacent to all its access doors. The number or letter shall be displayed in characters not less than 70 mm high and shall be visible when the door is open and closed.

| | | | |
|---|--|--------------------|------------------|
|  OTIF | Uniform Technical Prescription | | UTP PRM |
| | Accessibility for persons with disabilities and persons with reduced mobility | | Page 31 of 112 |
| Status: PROPOSAL | | TECH-25004 Annex 1 | Original: EN |
| | | | Date: 24.02.2025 |

- (7) If seats are identified by numbers or letters, the number or letter of the seat shall be displayed on or adjacent to every seat in characters not less than 12 mm high. Such numbers and letters shall contrast with their background.
- (8) Tactile information signage shall be fitted in:
 - Toilets and wheelchair accessible sleeping accommodation, for functional information and call for aid device if appropriate
 - Rolling stock, for the open/close button of passenger accessible doors and call for aid devices

4.2.2.7.3 *Dynamic Visual Information*

- (1) The final destination or route shall be displayed on the outside of the train on the platform side adjacent to at least one of the passenger access doors on ~~at least a minimum of~~ alternate vehicles of the train.
- (2) Where trains operate in a system, in which dynamic visual information is given on the station platform every 50 m or less, and destination or route information is also provided on the front of the train, it is not mandatory to provide information on the sides of vehicles.
- (3) The final destination or route of the train shall be displayed inside each vehicle.
- (4) The next stop of the train shall be displayed such that it can be read from ~~at least a minimum of~~ 51 % of passenger seats inside each vehicle including 51 % of the priority seats, and from all wheelchair spaces.
- (5) The dynamic visual information system shall have be able to display the next stop of the train~~This information shall be displayed~~ at least two minutes before arrival at the station concerned. If the next station is less than two minutes planned journey time away, the system shall be able to display the next station ~~shall be displayed~~ immediately following departure from the previous station.
- (6) The requirement in point (4)~~to make the destination and 'next stop' information visible from 51 % of passenger seats~~ does not apply to compartment carriages where the compartments have a maximum of 8 seats and are served by an adjacent corridor. However, that~~is~~ information shall be visible to a person standing in a corridor outside a compartment and to a passenger occupying a wheelchair space.
- (7) The dynamic visual information system may display information about the next stop ~~may be displayed~~ on the same support as the final destination. ~~However, it shall revert to show the final destination as soon as the train has stopped.~~
- (8) If the system is automated, it shall be possible to suppress or correct incorrect or misleading information.
- (9) Internal and external displays shall comply with the requirements of points (10) and (13)~~5.3.2.7~~. In those~~is~~ points, the term “display” shall be understood as any support of dynamic information.
- (10) Each station name (which may be abbreviated), or words of messages, shall be displayed for a minimum of 2 seconds.
- (11) If a scrolling display is used (either horizontal or vertical), each complete word shall be displayed for a minimum of 2 seconds and the horizontal scrolling speed shall not exceed an average of 6 characters per second.

| | | | |
|---|--|--------------------|------------------|
|  OTIF | Uniform Technical Prescription | | UTP PRM |
| | Accessibility for persons with disabilities and persons with reduced mobility | | Page 32 of 112 |
| Status: PROPOSAL | | TECH-25004 Annex 1 | Original: EN |
| | | | Date: 24.02.2025 |

- (12) [On external displays the minimum character height shall be 70 mm on front displays and 35 mm on side displays.](#)
- (13) [Internal displays shall be designed for a maximum viewing distance in accordance with the formula in Table 5a.](#)

Table 5a: Maximum viewing distance of the internal displays for rolling stock

| <u>Reading distance</u> | <u>Character height</u> |
|--------------------------|----------------------------------|
| <u>< 8750 mm</u> | <u>(reading distance/250) mm</u> |
| <u>8750 to 10 000 mm</u> | <u>35 mm</u> |
| <u>> 10 000mm</u> | <u>(reading distance/285) mm</u> |

4.2.2.7.4 *Dynamic audible information*

- (1) The train shall be fitted with a public address system which shall be used either for routine or emergency announcements by the driver or by another crew member who has specific responsibility for passengers.
- (2) The public address system may operate on a manual, an automated or pre-programmed basis. If the public address system is automated, it shall be possible to suppress, or correct, incorrect or misleading information.
- (3) The public address system shall be capable of announcing the destination and next stop of the train at each stop, or on departure from each stop.
- (4) The public address system shall be capable of announcing the next stop of the train at least two minutes before the arrival of the train at that stop. If the next station is less than two minutes planned journey time away, the next station shall be announced immediately following departure from the previous station.
- (5) The spoken information shall have a minimum STI-PA level of 0.45, in accordance with the specification referenced in Appendix A, index [5]. The public address system shall meet the requirement at all seat locations and wheelchair spaces.

4.2.2.8 *Height changes*

- (1) Internal steps (other than those for external access) shall have a maximum height of 200 mm and a minimum depth of 280 mm, measured at the central axis of the stairs. For double deck trains it is permitted to reduce this value to 270 mm for the stairs accessing the upper deck and the lower deck.
- (2) As a minimum, the first and the last steps shall be indicated by a contrasting band ~~with a depth of 45 mm to 55 mm~~ extending the full width of the steps on both the front and the top surfaces of the step nosing with a depth of:
 - 45 mm to 55 mm on the front surface.
 - 45 mm to 75 mm on the top surface.

| | | | |
|---|--|--------------------|------------------|
|  OTIF | Uniform Technical Prescription | | UTP PRM |
| | Accessibility for persons with disabilities and persons with reduced mobility | | Page 33 of 112 |
| Status: PROPOSAL | | TECH-25004 Annex 1 | Original: EN |
| | | | Date: 24.02.2025 |

- (3) Stairs constituted of more than three steps shall be provided with handrails on both sides and at two levels. The higher handrail shall be positioned at a height of 850 mm to 1000 mm above floor level. The lower handrail shall be positioned at a height of 500 mm to 750 mm above floor level.
- (4) Stairs constituted of one, two or three steps shall be provided on both sides with a minimum of one handrail or other item that can be used for personal stability.
- (5) Handrails shall be compliant with point 4.2.2.9.
- (6) No steps are allowed between the vestibule of a wheelchair accessible exterior door, the wheelchair space, a universal sleeping compartment and the universal toilet except for a door threshold strip that shall not exceed 15 mm in height or except in case that a lift is provided to overcome the step. The lift shall comply with the requirements of point 5.3.2.10.
- (7) For ramps in rolling stock the maximum slope shall not exceed the following values:

Table 6: Maximum slope for ramps in rolling stock

| <u>Length of ramp</u> | <u>Maximum gradient (degrees)</u> | <u>Maximum gradient (%)</u> |
|---|-----------------------------------|-----------------------------|
| Paths between the vestibule of a wheelchair accessible exterior door, the wheelchair space, a wheelchair accessible sleeping accommodation and the universal toilet. | | |
| Up to 840 mm in single deck carriages | 6,84 | 12 |
| Up to 840 mm in double deck carriages | 8,5 | 15 |
| > 840 mm | 3,58 | 6,25 |
| Other areas of the train | | |
| > 1000 mm | 6,84 | 12 |
| 600 mm to 1000 mm | 8,5 | 15 |
| Less than 600 mm | 10,2 | 18 |

Note: These gradients shall be measured when the vehicle is stationary on straight and level track.

4.2.2.9 Handrails

- (1) All handrails fitted to a vehicle shall be round in section with an outside diameter of 30 mm to 40 mm, and shall have a minimum clear distance of 45 mm to any adjacent surface other than its mountings.

| | | | |
|---|--|--------------------|------------------|
|  OTIF | Uniform Technical Prescription | | UTP PRM |
| | Accessibility for persons with disabilities and persons with reduced mobility | | Page 34 of 112 |
| Status: PROPOSAL | | TECH-25004 Annex 1 | Original: EN |
| | | | Date: 24.02.2025 |

- (2) If a handrail is curved, the radius to the inside face of the curve shall be a minimum of 50 mm.
- (3) All handrails shall contrast with their background.
- (4) External doorways shall be provided with handrails on both sides, fitted internally as close as practicable to the vehicle outer wall. Exception can be made for one side of the doorway if it is fitted with a device such as an on-board lift.
- (5) These handrails referred to in point (4) shall be:
 - vertical handrails that shall extend from 700 mm to 1200 mm above the threshold of the first step for all external doorways;
 - additional handrails at a height of between 800 mm and 900 mm above the first useable step and parallel with the line of the step nosing for doorways with more than two entrance steps.
- (6) Where the clearway of the gangway is narrower than 1000 mm and longer than 2000 mm there shall be handrails or handholds provided in, or adjacent to, inter-vehicle gangways that are provided for passenger use.
- (7) Where the clearway of the gangway is wider than or equal to 1000 mm handrails or handholds shall be provided in the gangway.

4.2.2.10 Wheelchair accessible sleeping accommodation

- (1) When a train is equipped with sleeping accommodation for passengers, it shall provide a vehicle containing at least one wheelchair accessible sleeping accommodation.
- (2) If there is more than one vehicle with sleeping accommodation for passengers in a train, there shall be not less than two wheelchair accessible sleeping accommodations in the train.
- (3) If a rail vehicle provides wheelchair accessible sleeping accommodation, the exterior of the relevant vehicle door and the wheelchair accessible sleeping accommodation door shall be marked with a sign in accordance with [Appendix N](#).
- (4) The wheelchair accessible sleeping accommodation internal space shall take in consideration the requirements of point 4.2.2.6 for actions expected from the wheelchair user in the sleeping accommodation.
- (5) The sleeping accommodation shall be fitted with not less than two call for aid devices that shall when operated, send a signal to a person who can take appropriate action; they need not initiate a communication.
- (6) The interface of the call for aid devices shall be as defined in point 5.3.2.6.
- (7) One call for aid device shall be placed not more than 450 mm above the floor, measured vertically from the surface of the floor to the centre of the control. It shall be positioned so that the control can be reached by a person lying on the floor.
- (8) The other call for aid device shall be not less than 600 mm and not more than 800 mm above the floor measured vertically to the centre of the control.

| | | | |
|---|--|--------------------|------------------|
|  OTIF | Uniform Technical Prescription | | UTP PRM |
| | Accessibility for persons with disabilities and persons with reduced mobility | | Page 35 of 112 |
| Status: PROPOSAL | | TECH-25004 Annex 1 | Original: EN |
| | | | Date: 24.02.2025 |

- (9) These ~~two~~ call for aid devices [described in points \(7\) and \(8\)](#) shall be located on different vertical surfaces of the sleeping accommodation.
- (10) The call for aid devices shall be distinct from any other control within the sleeping accommodation, be coloured differently from other control devices and contrast with their background.

4.2.2.11 Step position for vehicle access and egress

4.2.2.11.1 General requirements

- (1) It shall be demonstrated that the point situated in the central position on the nose of the access step of each passenger access door on both sides of a vehicle in working order with new wheels standing centrally on the rails, shall be located inside the surface identified as "step location" on the figure 1 below.

Figure 1

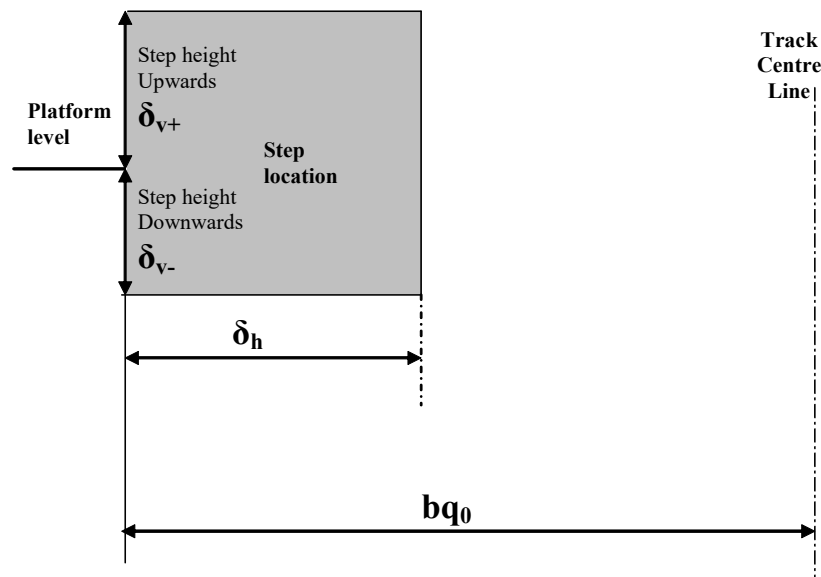

- (2) The values of bq_0 , δ_h , δ_{v+} and δ_{v-} depend on the type of platform where the rolling stock is intended to stop. They shall be as follows:

- bq_0 shall be calculated based on the gauge of the track in which the train is intended to operate in accordance with the specification referenced in Appendix A, index [8].

The calculation shall take into account the loading gauge(s) on which the vehicle is designed to be operated.

Gauges are defined in chapter 4.2.3.1 of INF TSI.

- δ_h , δ_{v+} and δ_{v-} are defined in tables 7 - 9.

| | | | |
|---|--|--------------------|------------------|
|  OTIF | Uniform Technical Prescription | | UTP PRM |
| | Accessibility for persons with disabilities and persons with reduced mobility | | Page 36 of 112 |
| Status: PROPOSAL | | TECH-25004 Annex 1 | Original: EN |
| | | | Date: 24.02.2025 |

Table 7 for all **Rolling **S**tock intended to stop, in normal operation, at platforms of 550 mm height:**

Table 7: Values of δ_h , δ_{v+} and δ_{v-} for a 550 mm platform

| | δ_h mm | δ_{v+} mm | δ_{v-} mm |
|---|---------------|------------------|------------------|
| on a straight level track | 200 | 230 | 160 |
| on a track with a curve radius of 300 m | 290 | 230 | 160 |

Table 8 for all **Rolling **S**tock intended to stop, in normal operation, at platforms of 760 mm height:**

Table 8: Values of δ_h , δ_{v+} and δ_{v-} for a 760 mm platform

| | δ_h mm | δ_{v+} mm | δ_{v-} mm |
|--|---------------|------------------|------------------|
| on a straight level track | 200 | 230 | 160 |
| on a track with a curve radius of 300m | 290 | 230 | 160 |

Table 9 for all **Rolling **S**tock intended to stop, in normal operation, at both platforms of 760 mm height and platforms of 550 mm height, and having two or more access steps:**

For one step, values of the table 7 above apply, and for the next step towards the vehicle interior the following values apply, based upon a nominal platform height of 760 mm:

Table 9: Values of δ_h , δ_{v+} and δ_{v-} for the second step for a 760 mm platform

| | δ_h mm | δ_{v+} mm | δ_{v-} mm |
|---|---------------|------------------|------------------|
| on a straight level track | 380 | 230 | 160 |
| on a track with a curve radius of 300 m | 470 | 230 | 160 |

(3) The technical documentation ~~requested~~ referred in point 4.2.12 of the UTP LOC&PAS shall include information about:

- the height and offset of the theoretical platform resulting in a vertical gap (δ_{v+}) of 230 mm and in a horizontal gap (δ_h) of 200 mm from the point situated in the central position of the nose of the rolling stock's lowest step on a straight level track.
- the height and offset of the theoretical platform resulting in a vertical gap (δ_{v-}) of 160 mm and in a horizontal gap (δ_h) of 200 mm from the point situated in the central position of the nose of the rolling stock's lowest step on a straight level track.

| | | | |
|---|--|--------------------|------------------|
|  OTIF | Uniform Technical Prescription | | UTP PRM |
| | Accessibility for persons with disabilities and persons with reduced mobility | | Page 37 of 112 |
| Status: PROPOSAL | | TECH-25004 Annex 1 | Original: EN |
| | | | Date: 24.02.2025 |

4.2.2.11.2 Access/egress steps

- (1) All steps for access and egress shall be slip resistant and shall have an effective clear width as large as the doorway width.
- (2) Internal steps for external access shall have a minimum depth of 240 mm between the vertical edges of the step and a maximum height of 200 mm. The height of each step may be increased to a maximum of 230 mm if it can be demonstrated that this achieves a reduction of one in the total number of steps required.
- (3) The rising height of each step shall be equal.
- (4) As a minimum the first and the last steps shall be indicated by a contrasting band with a depth of 45 mm to 55 mm extending a minimum of 80 % of the width of the steps on the top surface of the step nosing. A similar band shall indicate the front surface of the last step when entering the unit.
- (5) An external access step, fixed or moveable, shall have a maximum height of 230 mm between steps and a minimum depth of 150 mm.
- (6) If a step board is fitted and it is an extension of a door sill outside the vehicle, and there is no change in level between the step board and the floor of the vehicle, this shall not be considered to be a step for the purposes of this specification. A minimal drop in level, with a maximum of 60 mm, between the floor surface at door sill and that of the exterior of the vehicle, used to guide and seal the door is also permissible and shall not be considered as a step.
- (7) Access to the vestibule ~~of the vehicle~~ shall be achieved with a maximum of 4 steps of which one may be external.
- (8) Rolling ~~S~~stock intended to stop, in normal operation, at existing platforms below 380 mm height and having their passenger access doors above bogies need not comply with points (2) and (5) above if it can be demonstrated that this achieves a more even distribution of the steps heights.

4.2.2.12 Boarding aids

- (1) A secure storage system shall be provided to ensure that boarding aids, including portable ramps, do not impinge on a passenger's wheelchair or mobility aid or pose any hazard to passengers in the event of a sudden stop.
- (2) The following types of boarding aids may be present in the rolling stock according to the rules defined in point 4.4.3.

4.2.2.12.1 Movable step and bridging plate

- (1) A moveable step is a retractable device integrated into the vehicle lower than the door threshold level, fully automatic and activated in conjunction with the door opening/closing sequences.
- (2) A bridging plate is a retractable device integrated into the vehicle as close as possible to the door threshold level, fully automatic and activated in conjunction with the door opening/closing sequences.
- (3) ~~(Reserved) In the case of the movable step or bridging plate extending beyond that permitted by the gauging rules, the train shall be immobilised whilst the step or plate is extended.~~

| | | | | |
|---|--|--------------------|----------------|------------------|
|  OTIF | Uniform Technical Prescription | | UTP PRM | |
| | Accessibility for persons with disabilities and persons with reduced mobility | | Page 38 of 112 | |
| Status: PROPOSAL | | TECH-25004 Annex 1 | Original: EN | Date: 24.02.2025 |

- (4) The extension of the moveable step or bridging plate shall be completed before the door opening permits the passengers to cross and conversely, removal of the step or plate may only begin when the door opening no longer permits any crossing of passengers.
- (5) Movable steps and bridging plates shall comply with the requirements of point 5.3.2.8.

4.2.2.12.2 On-board ramp

- (1) An on-board ramp is a device that is positioned between the vehicle door threshold and the platform. It can be manual, semi-automatic or automatic.
- (2) On-board ramps shall comply with the requirements of point 5.3.2.9.

4.2.2.12.3 On-board lift

- (1) An on-board lift is a device integrated into the doorway area of a vehicle that shall be able to overcome the maximum height difference between the vehicle floor and the station platform where operated.
- (2) When the lift is in the stowed position, the doorway shall have a minimum useable width in accordance with point 4.2.2.3.2.
- (3) On-board lifts shall comply with the requirements of point 5.3.2.10.

4.3 Functional and technical specifications of the interfaces

The tables in section 4.3 are in a 5 column layout. The first column on the left hand side appears only in this UTP and not in EU law, to help explain the legal reference under COTIF.

4.3.1 Interfaces with the Infrastructure subsystem

Table 10: Interface with the infrastructure subsystem

| Reference to the COTIF provisions | Interface with the <u>I</u> nfrast <u>r</u> ucture subsystem | | | |
|---|--|--------------------|--------------------------------|-------|
| | UTP PRM | | UTP INF | |
| | Parameter | Point | Parameter | Point |
| In accordance with ATMF Article 6 § 2 <u>of the ATMF UR and with the UTP TCRC</u> , it is the responsibility of the rail transport <u>railway</u> undertaking to ensure the compatibility of the vehicle with the infrastructure it is operated on. | Step position for vehicle access and egress | 4.2.2.11 | Platforms | 4.2.9 |
| | Specific cases about the step position for vehicle access and egress | 7.3.2.6 | Specific cases about platforms | 7.7 |

| | | | | |
|---|--|--------------------|----------------|------------------|
|  OTIF | Uniform Technical Prescription | | UTP PRM | |
| | Accessibility for persons with disabilities and persons with reduced mobility | | Page 39 of 112 | |
| Status: PROPOSAL | | TECH-25004 Annex 1 | Original: EN | Date: 24.02.2025 |

4.3.2 Interfaces with the Rolling Stock subsystem

Table 11: Interface with the Rolling Stock subsystem

| Reference to the COTIF provisions- | Interface with the rolling stock subsystem | | | |
|--|--|-----------------------------|---|---------------------------|
| | UTP PRM | | UTP LOC&PAS | |
| | Parameter | Point | Parameter | Point |
| Set out by the UTP LOC&PAS (Point 4.2.5) and by this UTP | Rolling Stock subsystem | 4.2.2 | Passenger related items | 4.2.5 |
| | Rolling stock intended to be operated exclusively within a seat reservation system | 4.2.2.1.2.1 | General documentation | 4.2.12.2 |
| | Height and offset of theoretical platforms | 4.2.2.11.1 | General documentation | 4.2.12.2 |
| | Movable step and bridging plate | 4.2.2.12.1 | Door-traction interlock | 4.2.5.5.7 |

4.3.3 Interfaces with the Telematics Applications for Passengers subsystem

Table 12: Interface with the Telematics Applications for Passengers subsystem⁹

| Reference to the COTIF provisions- | Interface with the TAP subsystem | | | |
|--|---|-------|---|--|
| | UTP PRM | | Telematics applications | |
| | Parameter | Point | Parameter | |
| TAP is included in the functional subsystems of the UTP GEN-B. However, there are no harmonised COTIF requirements for telematics applications for | Station accessibility Assistance to board and alight the train | 4.4.1 | Handling of information concerning carriage and assistance of persons with disabilities and persons with reduced mobility | |

⁹ TAP TSI means Commission Regulation (EU) No 454/2011 of 5 May 2011 as last amended by Commission Implementing Regulation (EU) 2019/775 of 16 May 2019 on the technical specification for interoperability relating to the subsystem 'telematics applications for passenger services'. The references to the TAP TSI are set out in Table 12 of the PRM TSI.

| | | | | |
|---|--|--------------------|----------------|------------------|
|  OTIF | Uniform Technical Prescription | | UTP PRM | |
| | Accessibility for persons with disabilities and persons with reduced mobility | | Page 40 of 112 | |
| Status: PROPOSAL | | TECH-25004 Annex 1 | Original: EN | Date: 24.02.2025 |

| | | | | |
|---|--|--------------|---|--|
| <p>Reference to the COTIF provisions-</p> <p>passengers in COTIF. Legal provisions which concern telematics applications for passengers may apply in Member Contracting States, including the TAP TSI in states which apply EU law. It is the responsibility of the railway undertaking that uses the vehicles to ensure that the interfaces function in compliance with the applicable rules.</p> | Interface with the TAP subsystem | | | |
| | UTP PRM | | Telematics applications | |
| | Parameter | Point | Parameter | |
| | Assistance to board and alight the train | 4.4.2 | Handling of information concerning carriage and assistance of persons with disabilities and persons with reduced mobility | |
| | Access and reservation | 4.4.2 | Handling of availability/reservation | |
| | Visual information | 4.2.1.10 | Handling of information provision in the station area | |
| | Spoken information | 4.2.1.11 | Handling of information provision in the station area | |
| | Customer information | 4.2.2.7 | Handling of information provision in the vehicle area | |

4.4 Operating rules

When using rolling stock within the scope of this UTP in international traffic, railway undertakings must comply with the rules applicable in the state concerned, including the EU rules reproduced in the right-hand column in states which apply EU law.

In general, operating rules are not harmonised within the scope of this UTP, with the exception of operational rules which are directly related to the vehicles and which are indispensable for the safe and correct use of vehicles in international traffic.

The following operating rules do not form part of the assessment of subsystems.

This TSI does not specify operating rules for evacuation in the case of hazardous situations, only the relevant technical requirements. The purpose of the technical requirements for ~~I~~nfrastructure and ~~R~~olling ~~S~~tock is to facilitate evacuation for all, including persons with disabilities and persons with reduced mobility. The following operating rules apply to the operation of the whole infrastructure and rolling stock subsystems.

4.4.1 Infrastructure subsystem

[reserved]

In light of the essential requirements in section 3, the operating rules specific to the

| | | | |
|---|--|--------------------|------------------|
|  OTIF | Uniform Technical Prescription | | UTP PRM |
| | Accessibility for persons with disabilities and persons with reduced mobility | | Page 41 of 112 |
| Status: PROPOSAL | | TECH-25004 Annex 1 | Original: EN |
| | | | Date: 24.02.2025 |

infrastructure subsystem related to accessibility for persons with disabilities and persons with reduced mobility are as follows:

- General

The ~~I~~nfrastructure ~~M~~anager or ~~S~~tation ~~M~~anager ~~or railway undertaking~~ shall have a written policy to ensure that all persons with disabilities and persons with reduced mobility can access the passenger infrastructure at all operational times in accordance with the technical requirements of this TSI. Furthermore, the policy shall be compatible with any ~~R~~ailway ~~U~~ndertaking's ~~policy~~ that may wish to use the facilities, (refer to point 4.4.2) as appropriate. The policy shall be implemented through the provision of adequate information to staff, procedures and training. The Infrastructure policy shall include, but not be limited to, operating rules for the following situations:

- Station Accessibility

Operating rules shall be made to ensure that information regarding the level of accessibility of all stations is available.

- Unstaffed Stations – Ticketing for Visually Impaired Passengers

Operating rules shall be written and implemented with respect to unstaffed stations where vending machines are relied upon for ticketing (refer to point 4.2.1.8). In such situations, an alternative means of ticketing, accessible to visually impaired passengers, shall always be available (for example, permitting purchasing either on the train or at the destination).

- Ticketing Control – Turnstiles

In cases where turnstiles are utilised for ticketing control, operational rules shall be implemented, whereby disabled persons and persons with reduced mobility are offered parallel access through such control points. This special access shall permit wheelchair users, and may be controlled by staff or be automatic.

- Lighting of platforms

| | | | |
|---|--|--------------------|------------------|
|  OTIF | Uniform Technical Prescription | | UTP PRM |
| | Accessibility for persons with disabilities and persons with reduced mobility | | Page 42 of 112 |
| Status: PROPOSAL | | TECH-25004 Annex 1 | Original: EN |
| | | | Date: 24.02.2025 |

It is allowed that lighting be switched off on platforms where no train is expected.

- Visual and Spoken Information – Achieving Consistency

Operating rules shall be implemented to ensure consistency between essential visual and spoken information (refer to points 4.2.1.10 and 4.2.1.11). Staff making announcements shall follow standard procedures to achieve complete consistency of essential information.

Advertisements shall not be combined with the routing information.

Note: General information about public transport services shall not be considered as advertisements for the purposes of this point.

- On-demand Spoken Passenger Information System

Where spoken information is not provided via a public address system at a station (refer to point 4.2.1.11), operating rules shall be implemented to ensure the provision of an alternative information system, whereby passengers are able to acquire the same information audibly at the station (e.g. a staffed or automated telephone information service).

- Platform – Wheelchair Boarding Aid Operational Zone

The Rrailway Undertaking and the Infrastructure Manager or Station Manager shall define together the area(s) on the platform where the facility is likely to be used, taking account of train composition variations.

Operational rules shall be implemented to determine, where possible, the stopping point of trains according to the location of this (or these) operational zone(s).

- Safety of Manual and Powered Wheelchair Boarding Aids

Operations rules shall be implemented concerning the operation of boarding aids by station staff (refer to point 4.2.1.14).

An operational rule shall be implemented concerning the use by staff of the moveable

| | | | |
|---|--|--------------------|------------------|
|  OTIF | Uniform Technical Prescription | | UTP PRM |
| | Accessibility for persons with disabilities and persons with reduced mobility | | Page 43 of 112 |
| Status: PROPOSAL | | TECH-25004 Annex 1 | Original: EN |
| | | | Date: 24.02.2025 |

safety barrier fitted to wheelchair lifts (refer to point 4.2.1.14).

Operational rules shall be implemented to ensure that staff is able to safely operate boarding ramps, with respect to deployment, securing, raising, lowering and stowing (refer to point 4.2.1.14).

- Assistance to board and alight the train

Operational rules shall be implemented to ensure that staff are aware that persons with disabilities and persons with reduced mobility may require assistance to board and alight the train, and shall provide such assistance if required.

Conditions on which assistance to persons with disabilities and persons with reduced mobility is provided are defined in Regulation [\(EU\) 2021/782 of the European Parliament and of the Council](#)¹⁰ ~~(EC) No 1371/2007~~¹¹.

- Supervised Level Track Crossing

Where supervised level track crossing is permitted, operating rules shall be implemented to ensure that staff at supervised level track crossings give appropriate assistance to persons with disabilities and persons with reduced mobility, including indication of when it is safe to cross the track.

4.4.2 Rolling Stock subsystem

In light of the essential requirements in ~~section~~ [Chapter 3](#), the operating rules specific to the **R**olling **S**tock subsystem related to accessibility for persons with disabilities and persons with reduced mobility are as follows:

[4.4.2.1 General](#)

[\(Reserved\)](#)

General

The **R**ailway **U**ndertaking shall have a written policy to ensure accessibility to passenger **R**olling **S**tock at all operational times in accordance with the technical requirements of

¹⁰ [Regulation \(EU\) 2021/782 of the European Parliament and of the Council of 29 April 2021 on rail passengers' rights and obligations \(recast\).](#)

~~¹¹ [Regulation \(EC\) No 1371/2007 of the European Parliament and of the Council of 23 October 2007 on rail passengers' rights and obligations \(OJ L 315, 3.12.2007, p. 14–41\).](#)~~

| | | | |
|---|--|--------------------|------------------|
|  OTIF | Uniform Technical Prescription | | UTP PRM |
| | Accessibility for persons with disabilities and persons with reduced mobility | | Page 44 of 112 |
| Status: PROPOSAL | | TECH-25004 Annex 1 | Original: EN |
| | | | Date: 24.02.2025 |

this TSI. Furthermore, the policy shall be compatible with the Infrastructure Manager or Station Manager policy (refer to point 4.4.1) as appropriate. The policy shall be implemented through the provision of adequate information to staff, procedures and training. The Rolling Stock policy shall include, but not be limited to, operating rules for the following situations:

4.4.2.2 Access to and Reservation of Priority Seats

(Reserved)

~~Access and Reservation of Priority Seats~~

Two possible conditions exist in connection with seats classified as ‘priority’; (i) unreserved and (ii) reserved (refer to point 4.2.2.1.2.1 (2)). In case (i), the operating rules will be directed to other passengers (i.e. provision of signage) requesting them to ensure that priority is given to all persons with disabilities and persons with reduced mobility that are defined as being eligible to use such seats and that occupied priority seats ~~are~~ ~~should~~ ~~be~~ given-up as appropriate. In case (ii) operating rules shall be implemented by the Railway Undertaking to ensure that the ticketing reservation system is equitable with regards to persons with disabilities and persons with reduced mobility. Such rules will ensure that priority seating is initially only available for reservation by persons with disabilities and persons with reduced mobility until a given cut-off period prior to departure. After ~~that~~ ~~is~~ point in time, priority seats will be made available to the entire passenger population, including persons with disabilities and persons with reduced mobility.

4.4.2.3 Carriage of Assistance Dogs

(Reserved)

~~Carriage of Assistance Dogs~~

Operating rules shall be made to ensure that persons with disabilities and persons with reduced mobility with an assistance dog shall not be charged extra.

4.4.2.4 Access to and Reservation of Wheelchair Spaces

(Reserved)

~~Access and Reservation of Wheelchair Spaces~~

| | | | |
|---|--|--------------------|------------------|
|  OTIF | Uniform Technical Prescription | | UTP PRM |
| | Accessibility for persons with disabilities and persons with reduced mobility | | Page 45 of 112 |
| Status: PROPOSAL | | TECH-25004 Annex 1 | Original: EN |
| | | | Date: 24.02.2025 |

The priority seating access and reservation rules also apply to wheelchair spaces, with only wheelchair users having priority. Additionally, operating rules shall provide for (i) unreserved or (ii) reserved accompanying persons (non-PRM) seating adjacent or facing the wheelchair space.

4.4.2.5 Access to and Reservation of Universal Sleeping Compartments

(Reserved)

~~Access and Reservation of Universal Sleeping Compartments~~

The priority seating reservation rules also apply to universal sleeping compartments (refer to point 4.2.2.10). However, operational rules shall prevent non-reserved occupation of universal sleeping compartments (i.e. advanced booking will always be necessary).

4.4.2.6 Train crew – exterior door activation

~~— Train crew – exterior doors activation~~

Operational rules shall be implemented regarding the procedure for external door activation by train crew to ensure safety of all passengers including persons with disabilities and persons with reduced mobility (refer to point 4.2.2.3.2).

4.4.2.7 Call for aid device in wheelchair space, universal toilets or wheelchair accessible sleeping accommodation

~~— Call for aid device in wheelchair space, universal toilets or wheelchair accessible sleeping accommodation~~

Operational rules shall be implemented to ensure appropriate response and action from the staff in the event of activation of the call for aid device (refer to ~~paragraphs~~ points 4.2.2.2, 4.2.2.5 and 4.2.2.10). Response and action need not be the same according to the origin of the call for aid.

4.4.2.8 Lighting

Where every passenger seat is equipped with an individual light, it is permitted to reduce the lighting level in the unit according to the type of operation (e.g. night service, passenger comfort). The requirements of the specification referenced in Appendix A, Index [6], shall be met.

4.4.2.9 Audible safety instructions in case of emergency

~~— Audible safety instructions in case of emergency~~

Operational rules shall be implemented regarding the transmission of audible safety instructions to passengers in the event of an emergency (refer to point 4.2.2.7.4). ~~The~~ ose rules shall include the nature of the instructions and of their transmission.

| | | | |
|---|--|--------------------|------------------|
|  OTIF | Uniform Technical Prescription | | UTP PRM |
| | Accessibility for persons with disabilities and persons with reduced mobility | | Page 46 of 112 |
| Status: PROPOSAL | | TECH-25004 Annex 1 | Original: EN |
| | | | Date: 24.02.2025 |

4.4.2.10 Visual and audible information – Control of advertisements

(Reserved)

~~Visual and audible Information – Control of Advertisements~~

Details of the ~~R~~route or ~~N~~etwork on which the train operates shall be available (~~the R~~railway ~~U~~ndertaking shall decide the manner in which this information is provided).

Advertisements shall not be combined with routing information.

Note: General information about public transport services shall not be considered as advertisements for the purposes of this point.

4.4.2.11 Automatic Information Systems – Manual Correction of incorrect or misleading information

(Reserved)

~~Automatic Information Systems – Manual Correction of incorrect or misleading information~~

Operational rules shall be implemented for the validation and ability to correct erroneous automatic information by the train crew (refer to point 4.2.2.7).

4.4.2.12 Rules for announcement of the final destination and the next stop

(Reserved)

~~Rules for announcement of the final destination and the next stop~~

Operational rules shall be implemented to ensure that the next stop is announced no later than 2 minutes prior to the event and that the dynamic information displays revert to show the final destination as soon as the train has stopped (refer to point 4.2.2.7).

4.4.2.13 Rules on train composition to make wheelchair boarding aid devices usable according to the arrangement of the platforms

~~Rules on train composition to make wheelchair boarding aid devices usable according to the arrangement of the platforms.~~

Operation rules shall be implemented to take account of train composition variations such that the safe operational zones for wheelchair boarding aids can be determined with respect to the stopping point of trains.

4.4.2.14 Safety of Manual and Powered Wheelchair Boarding Aids

~~Safety of Manual and Powered Wheelchair Boarding Aids~~

| | | | |
|---|--|--------------------|------------------|
|  OTIF | Uniform Technical Prescription | | UTP PRM |
| | Accessibility for persons with disabilities and persons with reduced mobility | | Page 47 of 112 |
| Status: PROPOSAL | | TECH-25004 Annex 1 | Original: EN |
| | | | Date: 24.02.2025 |

Operations rules shall be implemented concerning the operation of boarding aids by train and station staff. In the case of manual devices, procedures shall ensure that minimum physical effort is required from staff. In the case of powered devices, procedures shall ensure emergency fail-safe-operation in the event of loss of power. An operational rule shall be implemented concerning the use by train or station staff of the moveable safety barrier fitted to wheelchair lifts.

Operational rules shall be implemented to ensure that train and station staff is able to safely operate boarding ramps, with respect to deployment, securing, raising, lowering and stowing.

4.4.2.15 Assistance to board and alight from the train

~~— Assistance to board and alight the train~~

Operational rules shall be implemented to ensure that staff are aware that disabled persons and persons with reduced mobility may require assistance to board and alight the train, and shall provide such assistance if required.

Conditions on which assistance to persons with disabilities and persons with reduced mobility is provided are defined in Regulation [\(EU\) 2021/782](#) ~~(EC) No 1371/2007~~.

4.4.2.16 Platform – Wheelchair Boarding Aid Operational Zone

(Reserved)

~~Platform – Wheelchair Boarding Aid Operational Zone~~

The ~~R~~railway ~~U~~ndertaking and the ~~I~~nfrastructure ~~M~~anager or ~~S~~tation ~~M~~anager shall define together the area on the platform where the facility is likely to be used and shall demonstrate its validity. ~~Tha~~tis area shall be compatible with the existing platforms where the train is likely to stop.

As a consequence, ~~of above is that~~ the stopping point of the train shall in some cases be adjusted in order to comply with this requirement.

Operational rules shall be implemented to take account of train composition variations (refer to point 4.2.1.12) ~~so~~such that the stopping point of trains can be determined with respect to the boarding aid operational zones.

4.4.2.17 Emergency method to deploy moveable steps

~~— Emergency method to deploy moveable steps~~

Operational rules shall be implemented for the emergency stowage or deployment of the bridging plate in the case of power failure.

| | | | |
|---|--|--------------------|------------------|
|  OTIF | Uniform Technical Prescription | | UTP PRM |
| | Accessibility for persons with disabilities and persons with reduced mobility | | Page 48 of 112 |
| Status: PROPOSAL | | TECH-25004 Annex 1 | Original: EN |
| | | | Date: 24.02.2025 |

4.4.2.18 Operating combinations of rolling stock compliant and non-compliant with this UTP

(Reserved)

~~Operating combinations of Rolling Stock compliant and non-compliant with this TSI~~

When forming a train from a mixture of compliant and non-compliant ~~R~~olling ~~S~~tock, operational procedures shall be implemented to ensure that a minimum of two wheelchair spaces compliant with this TSI are provided on the train. If toilets are available on the train, it shall be ensured that wheelchair users have access to a universal toilet.

Under such ~~R~~olling ~~S~~tock combinations, procedures shall be in place to ensure that visual and audible route information is available on all vehicles.

It is accepted that dynamic information systems, ~~and~~ wheelchair space, ~~universal toilet,~~ ~~wheelchair accessible sleeping accommodation~~ ~~and~~ call for aid devices may not be fully functional when working in such formations.

4.4.2.19 Forming trains from individual vehicles compliant with this UTP

~~Forming trains from individual vehicles compliant with this UTP~~

When vehicles that have been individually assessed in accordance with point 6.2.7 are formed into a train, operational procedures shall be in place to ensure that the complete train complies with point 4.2 of this UTP.

4.4.2.20 Providing services on board trains

(Reserved)

When a service is provided to passengers in a specific area of a train that cannot be accessed by wheelchair users, operational means shall be in place to ensure that:

(a) free of charge assistance is available to assist wheelchair users reach the service; or

(b) the service is delivered free of charge to wheelchair users at the wheelchair spaces, unless the nature of the service makes it impossible to provide it remotely.

4.4.3 Provision of boarding aids and provision of assistance

[reserved]

The ~~I~~nfrastructure ~~M~~anager or ~~S~~tation ~~M~~anager and ~~R~~ailway ~~U~~ndertaking shall agree the provision and management of the boarding aids as well as the provision of

| | | | |
|---|--|--------------------|------------------|
|  OTIF | Uniform Technical Prescription | | UTP PRM |
| | Accessibility for persons with disabilities and persons with reduced mobility | | Page 49 of 112 |
| Status: PROPOSAL | | TECH-25004 Annex 1 | Original: EN |
| | | | Date: 24.02.2025 |

assistance and alternative transport in line with Regulation (EU) 2021/782~~1371/2007~~ in order to establish which party is responsible for the operation of boarding aids and alternative transport. The Infrastructure Manager (or Station Manager(s)) and Railway Undertaking shall ensure that the division of responsibilities they agree is the most viable overall solution.

Such agreements shall take into consideration the area of use of boarding aids referred to in points 5.3.1.2, 5.3.1.3, 5.3.2.9 and 5.3.2.10.

Such agreements shall define:

- (a) the station platforms where a boarding aid has to be operated by the Infrastructure Manager or the Station Manager and the Rolling Stock for which it will be used;
- (b) the station platforms where a boarding aid has to be operated by the Railway Undertaking and the Rolling Stock for which it will be used;
- (c) the Rolling Stock where a boarding aid has to be provided and operated by the Railway Undertaking and the station platform where it will be used;
- (d) the Rolling Stock where a boarding aid has to be provided by the Railway Undertaking and operated by the Infrastructure Manager or Station Manager, and the station platforms where it will be used;
- (e) for boarding aids located on the platforms, the location where they are most likely to be used, taking into account that a free space (no obstacles) of 150 cm is available from the edge of the boarding aid towards the direction where the wheelchair boards/lands at/to the platform level;
- (f) the conditions for the provision of alternative transport where:
 - the platform cannot be reached through an obstacle-free route, or

| | | | |
|---|--|--------------------|------------------|
|  OTIF | Uniform Technical Prescription | | UTP PRM |
| | Accessibility for persons with disabilities and persons with reduced mobility | | Page 50 of 112 |
| Status: PROPOSAL | | TECH-25004 Annex 1 | Original: EN |
| | | | Date: 24.02.2025 |

- assistance cannot be provided to deploy a boarding aid between the platform and the rolling stock.

4.5 Maintenance rules

4.5.1 Infrastructure Subsystem

The requirement in this clause relates to the operational performance of the infrastructure during maintenance. Compliance with this clause in non-EU Contracting States is recommended but not mandatory, as the application of this UTP to the infrastructure subsystem is not mandatory.

The **I**nfrastructure **M**anager or **S**tation **M**anager shall have procedures that include the provision of alternative assistance to disabled persons and persons with reduced mobility during maintenance, replacement or repair of facilities that are for use of persons with disabilities and persons with reduced mobility.

4.5.2 Rolling Stock Subsystem

If a facility that has been incorporated for persons with disabilities and persons with reduced mobility becomes defective (this includes tactile signs), the **R**ailway **U**ndertaking shall ensure that he has procedures for the facility to be repaired or replaced within 6 working days of the occurrence being reported.

4.6 Professional qualifications

The requirements in this clause apply to professional qualifications of staff of which the activities may affect the technical state of rolling stock and its use. Its application is mandatory in the context of rolling stock maintenance. Its application is recommended in the context of rolling stock operations.

The professional qualifications of staff required for the operation and maintenance of the

Infrastructure or

Rolling **S**tock **S**ubsystems according to the technical scope as defined in point 1.1, and according to point 4.4 giving the list of operational rules, concerned by this UTP, are as follows:

Professional training of staff performing the tasks of accompanying trains, delivering service and help for passengers at a station and of selling tickets shall include the subject of disability awareness and equality, including the specific needs of all persons with disabilities and persons with reduced mobility.

| | | | |
|---|--|--------------------|------------------|
|  OTIF | Uniform Technical Prescription | | UTP PRM |
| | Accessibility for persons with disabilities and persons with reduced mobility | | Page 51 of 112 |
| Status: PROPOSAL | | TECH-25004 Annex 1 | Original: EN |
| | | | Date: 24.02.2025 |

Professional training of engineers and managers, responsible for maintaining

rolling stock, are recommended to

and operating the **I**nfrastructure or the **R**olling **S**tock, shall

include the subject of disability awareness and equality, including the specific needs of all persons with disabilities and persons with reduced mobility.

4.7 Health and safety conditions

There is neither specific requirement in the scope of this UTP related to the health and safety conditions of staff required for the operation of the **I**nfrastructure or **R**olling **S**tock **S**ubsystem nor for the implementation of the UTP.

~~4.8—Infrastructure and rolling stock registers~~

~~4.8.1—Infrastructure register~~

~~[reserved]~~

~~The characteristics of the infrastructure that must be recorded in the “register of railway infrastructure” are listed in Commission implementing decision 2011/633/EU¹².~~

~~4.8.2—Rolling Stock register~~

~~[reserved]~~

~~The characteristics of the rolling stock that must be recorded in the “European register of authorised types of vehicles” are listed in Commission implementing decision 2011/665/EU¹³.~~

5. INTEROPERABILITY CONSTITUENTS

5.1 Definition

Interoperability constituents (ICs)⁷ are defined in Article 2(g) of ATMF.

~~According to Article 2(f) of Directive 2008/57/EC, “interoperability constituents” means any elementary component, group of components, subassembly or complete assembly of equipment incorporated or intended to be incorporated into a subsystem, upon which the interoperability of the rail system depends directly or indirectly.~~

¹²—Commission Implementing Decision 2011/633/EU of 15 September 2011 on the common specifications of the register of railway infrastructure (OJ L 256, 1.10.2011, p. 1–25).

¹³—Commission Implementing Decision 2011/665/EU of 4 October 2011 on the European register of authorized types of railway vehicles (OJ L 264, 8.10.2011, p. 32–54).

| | | | |
|---|--|--------------------|------------------|
|  OTIF | Uniform Technical Prescription | | UTP PRM |
| | Accessibility for persons with disabilities and persons with reduced mobility | | Page 52 of 112 |
| Status: PROPOSAL | | TECH-25004 Annex 1 | Original: EN |
| | | | Date: 24.02.2025 |

~~The concept of a ‘constituent’ covers both tangible objects and intangible objects such as software.~~

An IC shall comply with the technical specifications of this chapter whether it is assessed separately as an IC or is assessed as an integrated part of a subsystem.

~~Assessment of IC separate from the subsystem is not mandatory in the COTIF regulations. Contracting States or regional organisations¹⁴ may require mandatory separate~~ The assessment of ICs separate from the subsystem shall be carried out according to the specification in sections 5.3 and 6.1 of this UTP.

~~Separate assessment of an IC:~~

~~If the IC is in conformity with this UTP, as evidenced by the manufacturer in the form of a declaration of conformity or suitability for use according to section 6.1 of this UTP and chapter 2 of UTP GEN D, the IC shall be permitted to be used in accordance with its defined area of use, in accordance with section 5.3, in all Contracting States.~~

~~Assessment of an IC integrated into a vehicle:~~

If the IC is assessed as a part of the subsystem, the assessment procedures for subsystems apply. The applicable requirements are ~~identical to those if the IC were to be assessed separately, i.e.~~ those set out in sections 5.3 and 6.1.

5.2 Innovative solutions

As stated in point 4.1 of this UTP, innovative solutions may require new specification and / or new assessment methods. These specifications and assessment methods shall be developed by the process described in

the UTP LOC&PAS.

article 6 of the Regulation⁽¹⁵⁾.

5.3 List and characteristics of constituents

The interoperability constituents are covered by the relevant provisions of

APTU and ATMF

Directive [\(EU\) 2016/797](#)~~2008/57/EC~~

and are listed below.

¹⁴ ~~In particular, compliance with EU law must be ensured when placing an IC on the market in the European Union.~~

¹⁵ The provisions are set out in Article 6 of the Regulation enacting the PRM TSI.

| | | | |
|---|--|--------------------|------------------|
|  OTIF | Uniform Technical Prescription | | UTP PRM |
| | Accessibility for persons with disabilities and persons with reduced mobility | | Page 53 of 112 |
| Status: PROPOSAL | | TECH-25004 Annex 1 | Original: EN |
| | | | Date: 24.02.2025 |

5.3.1 Infrastructure

The application of this UTP to infrastructure is not mandatory. Consequently, the application of this UTP is not mandatory for interoperability constituents for infrastructure ~~either~~.

The following items are identified as being interoperability constituents for Infrastructure:

5.3.1.1 ~~(Reserved)~~ Displays

- ~~(1) Displays shall be sized to show individual station names or words of messages. Each station name, or words of messages, shall be displayed for a minimum of 2 seconds.~~
- ~~(2) If a scrolling display is used (either horizontal or vertical), each complete word shall be displayed for a minimum of 2 seconds and the horizontal scrolling speed shall not exceed 6 characters per second.~~
- ~~(3) Displays shall be designed and assessed for an area of use defined by the maximum viewing distance according to the following formula:
Reading distance in mm divided by 250 = font size (for example: 10.000 mm / 250 = 40 mm).~~

5.3.1.2 Platform ramps

- (1) Ramps shall be designed and assessed for an area of use defined by the maximum vertical gap they can overcome within a maximum slope of 18-% ~~(10.2°)~~.
- (2) Ramps shall accommodate a wheelchair with characteristics as detailed in ~~a~~Appendix M.
- (3) Ramps shall withstand a weight of at least 300 kg, placed at the centre of the device distributed over an area of 660 mm by 660 mm.
- (4) If the ramp is power operated it shall incorporate a method of manual operation should power fail.
- (5) The ramp surface shall be slip resistant and shall have a stable position with an effective clear width of a minimum of 760 mm.
- (6) Ramps having a clear width of less than 1000 mm shall have raised edges on both sides to prevent mobility aid wheels from slipping off.
- (7) The upstands at both ends of the ramp shall be bevelled and shall not be higher than 20 mm. They shall have contrasting hazard warning bands.
- (8) The ramp shall be equipped with a mechanism to securely locate the ramp so that it is not subject to displacement when in use for boarding or alighting.
- (9) The ramp shall be provided with self-contrasting markings.

| | | | |
|---|--|--------------------|------------------|
|  OTIF | Uniform Technical Prescription | | UTP PRM |
| | Accessibility for persons with disabilities and persons with reduced mobility | | Page 54 of 112 |
| Status: PROPOSAL | | TECH-25004 Annex 1 | Original: EN |
| | | | Date: 24.02.2025 |

5.3.1.3 Platform lifts

- (1) Lifts shall be designed and assessed for an area of use defined by the maximum vertical gap they can overcome.
- (2) Lifts shall accommodate a wheelchair with characteristics as detailed in [Appendix M](#).
- (3) Lifts shall withstand a weight of at least 300 kg, placed at the centre of the device distributed over an area of 660 mm by 660 mm.
- (4) The lift platform surface shall be slip resistant.
- (5) At surface level, the lift platform shall have a minimum clear width of 800 mm and a length of 1200 mm. According to [Appendix M](#), an additional length of 50 mm shall be available for feet above a height of 100 mm above the lift platform, considering both inboard and outboard orientations of the wheelchair user
- (6) The bridging plate overriding the gap between the lift platform and the carriage floor shall have a [stable position with a](#) minimum width of 760 mm.
- (7) Where provided, each control for deploying, lowering to ground level, raising and stowing the lift shall require continuous manual pressure by the operator and shall not allow an improper lift sequencing when the lift platform is occupied.
- (8) The lift shall incorporate a method of deploying, lowering to ground level with a lift occupant, and raising and stowing the empty lift if the power to the lift fails.
- (9) No part of the lift platform shall move at a rate exceeding 150 mm/second during lowering and lifting an occupant, and shall not exceed 600 mm/second during deploying or stowing (except if the lift is manually deployed or stowed).
- (10) The maximum lift platform horizontal and vertical acceleration when occupied shall be 0.3g.
- (11) The lift platform shall be equipped with barriers to prevent any of the wheels of a wheelchair from rolling off the lift platform during its operation.
- (12) A movable barrier or inherent design feature shall prevent a wheelchair from rolling off the edge closest to the vehicle until the lift is in its fully raised position.
- (13) Each side of the lift platform which extends beyond the vehicle in its raised position shall have a barrier a minimum 25 mm high. Such barriers shall not interfere with manoeuvring into or out of the aisle.
- (14) The loading-edge barrier (outer barrier) which functions as a loading ramp when the lift is at ground level, shall be sufficient when raised or closed, or a supplementary system shall be provided, to prevent a power wheelchair from riding over or defeating it.
- (15) The lift shall permit both inboard and outboard orientation of the wheelchair user.
- (16) The lift shall be provided with self-contrasting markings.

| | | | |
|---|--|--------------------|------------------|
|  OTIF | Uniform Technical Prescription | | UTP PRM |
| | Accessibility for persons with disabilities and persons with reduced mobility | | Page 55 of 112 |
| Status: PROPOSAL | | TECH-25004 Annex 1 | Original: EN |
| | | | Date: 24.02.2025 |

5.3.2 Rolling stock

The following items are identified as being interoperability constituents for **R**olling **S**tock:

5.3.2.1 Interface of the door control device

- (1) A door control device shall have visual indication, on or around it when enabled and shall be operable by the palm of the hand exerting a force not greater than 15 N.
- (2) It shall be identifiable by touch (for example: tactile markings); this identification shall indicate the functionality.

5.3.2.2 Standard and universal toilets: common parameters

- (1) The centre of any door handle, lock or door control device on the exterior or interior of the toilet compartment shall be located at a minimum of 800 mm and a maximum of 1100 mm above the toilet door threshold.
- (2) A visual and tactile (or audible) indication shall be given inside and outside the toilet to indicate when a door has been locked.
- (3) Any door control device and other equipment inside the toilet compartment (except for baby nappy change facilities and call for aid devices) shall be operable by exerting a force not exceeding 20 N.
- (4) Any control device, including flushing system, shall contrast with the background surface, and shall be identifiable by touch.
- (5) Clear, precise information for the operation of any control device shall be provided, making use of pictograms and shall be tactile.
- (6) The toilet seat and lid, and any handrails shall contrast with the background.
- (7) If both opened and closed door control devices are fitted one above the other, the top device shall always be the open control.
- (8) Automatic and semi-automatic doors shall incorporate devices that prevent passengers becoming trapped during operation of the doors.
- (9) The force required to open or close a manual door shall not exceed 60 N.

5.3.2.3 Standard toilet

- (1) A standard toilet is not designed to be accessible to a wheelchair user.
- (2) The minimum door useable width shall be 500 mm.
- (3) A fixed vertical and/or horizontal handrail according to point 4.2.2.9 shall be provided adjacent to the toilet seat and the wash basin.

| | | | |
|---|--|--------------------|------------------|
|  OTIF | Uniform Technical Prescription | | UTP PRM |
| | Accessibility for persons with disabilities and persons with reduced mobility | | Page 56 of 112 |
| Status: PROPOSAL | | TECH-25004 Annex 1 | Original: EN |
| | | | Date: 24.02.2025 |

5.3.2.4 Universal toilet

- (1) A universal toilet is a toilet designed to be used by all passengers including all persons with disabilities and persons with reduced mobility.
- (2) The area of use of a universal toilet is defined by the method used for its assessment (A or B according to point 6.1.3.1)
- (3) The toilet access door shall provide a minimum clear useable width of 800 mm. Where the door is automatic or semi-automatic, it shall be possible to open it partially in order to allow a wheelchair user's assistant to leave and re-enter the toilet module.
- (4) The exterior of the door shall be marked with a sign in accordance with [Appendix N](#).
- (5) There shall be sufficient space inside the toilet compartment to enable a wheelchair as defined in [Appendix M](#) to be manoeuvred to a position allowing both a lateral and a diagonal transfer of the wheelchair occupant to the toilet seat.
- (6) There shall be a minimum clear space of 700 mm in front of the toilet seat that shall follow the seat profile.
- (7) A horizontal handrail that complies with the requirements of point 4.2.2.9 shall be provided at each side of the toilet seat extending at least to the leading edge of the toilet seat.
- (8) The handrail on the wheelchair accessible side shall be hinged in such a way so as to enable an unobstructed transfer for the wheelchair user to and from the toilet seat.
- (9) The surface of the toilet seat, when lowered, shall be at a height of 450 mm to 500 mm above the floor level.
- (10) All amenities shall be readily accessible to a wheelchair user.
- (11) The toilet cubicle shall be fitted with not less than two call for aid devices that shall, when operated, send a signal to a person who can take appropriate action; they need not initiate a communication.
- (12) The interface of the call for aid devices shall be as defined in point 5.3.2.6.
- (13) One call for aid device shall be placed not more than 450 mm above the floor, measured vertically from the surface of the floor to the centre of the control. It shall be positioned so that the control can be reached by a person lying on the floor.
- (14) The other call for aid device shall be not less than 800 mm and not more than 1100 mm above the floor, measured vertically to the centre of the control.
- (15) These two call for aid devices shall be located on different vertical surfaces of the cubicle so that they can be reached from a range of positions.
- (16) The control of the call for aid devices shall be distinct from any other control within the toilet, be coloured differently from other control devices and contrast with their background.

| | | | |
|---|--|--------------------|------------------|
|  OTIF | Uniform Technical Prescription | | UTP PRM |
| | Accessibility for persons with disabilities and persons with reduced mobility | | Page 57 of 112 |
| Status: PROPOSAL | | TECH-25004 Annex 1 | Original: EN |
| | | | Date: 24.02.2025 |

- (17) If a baby nappy changing table is provided, in the lowered position its usable surface shall be between 800 mm and 1000 mm above floor level.

5.3.2.5 Baby nappy changing table

- (1) The usable surface of the baby nappy changing table shall be a minimum of 500 mm wide and 700 mm long.
- (2) It shall be designed to prevent a baby from inadvertently sliding off, shall have no sharp edges and shall be able to take a minimum load of 80 kg.
- (3) It shall be possible to put it into the stowed position with only one hand, using a force not exceeding 25 N.

5.3.2.6 Interface of the call for aid device

A call for aid device shall:

- (1) Be indicated by a sign having a ~~green or~~ yellow background contrasting with a black symbol (in accordance with the specification referenced in appendix A, index [10]). ~~and a white~~ The symbol, shall representing a bell or a telephone. ~~;~~ † The sign can be on the button or bezel or on a separate pictogram,
- (2) Include tactile symbols,
- (3) Emit a visual and audible indication to the user that it has been operated,
- (4) Provide additional operating information if necessary,
- (5) Be operable by the palm of a person's hand and not require a force exceeding 30 N to operate.

5.3.2.7 (Reserved) ~~Internal and External Displays~~

- ~~(1) Each station name (which may be abbreviated), or words of messages, shall be displayed for a minimum of 2 seconds.~~
- ~~(2) If a scrolling display is used (either horizontal or vertical), each complete word shall be displayed for a minimum of 2 seconds and the horizontal scrolling speed shall not exceed an average of 6 characters per second.~~
- ~~(3) The typeface used for texts shall be easily readable.~~
- ~~(4) Upper Case Letters and numbers used in external displays shall have a minimum height of 70 mm on front displays and 35 mm on side displays.~~
- ~~(5) Internal displays shall be designed and assessed for an area of use defined by the maximum viewing distance according to the following formula:~~

| | | | |
|---|--|--------------------|------------------|
|  OTIF | Uniform Technical Prescription | | UTP PRM |
| | Accessibility for persons with disabilities and persons with reduced mobility | | Page 58 of 112 |
| Status: PROPOSAL | | TECH-25004 Annex 1 | Original: EN |
| | | | Date: 24.02.2025 |

Table 13: Area of use of the internal displays for Rolling Stock

| Reading distance | Height of upper case letters and numbers |
|-----------------------------|---|
| < 8750 mm | (reading distance / 250) mm |
| 8750 to 10000 mm | 35 mm |
| > 10000 mm | (reading distance / 285) mm |

5.3.2.8 Boarding aids: movable steps and bridging plates

- (1) A movable step or bridging plate shall be designed and assessed for an area of use defined by the width of the doorway it can fit.
- (2) The mechanical strength of the device shall be according to the specification referenced in Appendix A, index [11].
- (3) A suitable mechanism shall be installed in order to ensure the stability of the device in the deployed and retracted position.
- (4) The device surface shall be slip resistant and shall have an effective clear width as large as the doorway width.
- (5) The device shall be equipped with obstacle detection according to the specification referenced in Appendix A, index [11].
- (6) The device shall incorporate a method of deploying and stowing if the power to the step fails.

5.3.2.9 Boarding aids: on-board ramps

- (1) Ramps shall be designed and assessed for an area of use defined by the maximum vertical gap they can overcome within a maximum slope of 18-% (10.2°).
- (2) Ramps shall withstand a weight of at least 300 kg, placed at the centre of the ramp distributed over an area of 660 mm by 660 mm.
- (3) An access ramp shall be either positioned manually by staff or deployed semi-automatically by mechanical means, operated by staff or by the passenger.
- (4) If the ramp is power operated it shall incorporate a method of manual operation should power fail.
- (5) The ramp surface shall be slip resistant and shall have an effective clear width of a minimum of 760 mm.
- (6) Ramps having a clear width of less than 1000 mm shall have raised edges on both sides to prevent mobility aid wheels from slipping off.
- (7) The upstands at both ends of the ramp shall be bevelled and shall not be higher than 20 mm. They shall have contrasting hazard warning bands.

| | | | |
|---|--|--------------------|------------------|
|  OTIF | Uniform Technical Prescription | | UTP PRM |
| | Accessibility for persons with disabilities and persons with reduced mobility | | Page 59 of 112 |
| Status: PROPOSAL | | TECH-25004 Annex 1 | Original: EN |
| | | | Date: 24.02.2025 |

- (8) When in use for boarding or alighting, the ramp shall be secured in use so that it is not subject to displacement when loading or unloading.
- (9) A semi-automatic ramp shall be fitted with a device capable of stopping the movement of that step if its front edge comes into contact with anything or person whilst the plate is in movement.
- (10) The ramp shall be provided with self-contrasting markings.

5.3.2.10 Boarding aids: on-board lifts

- (1) Lifts shall be designed and assessed for an area of use defined by the maximum vertical gap they can overcome.
- (2) The lift platform surface shall be slip resistant. At surface level, the lift platform shall have a minimum clear width of 760 mm and a length of 1200 mm. According to [Appendix M](#), an additional length of 50 mm shall be available for feet above a height of 100 mm above the lift platform, considering both inboard and outboard orientations of the wheelchair user.
- (3) The bridging plate overriding the gap between the lift platform and the carriage floor shall have a minimum width of 720 mm.
- (4) The lift shall withstand a weight of at least 300 kg, placed at the centre of the lift platform distributed over an area of 660 mm by 660 mm.
- (5) Where provided, each control for deploying, lowering to ground level, raising and stowing the lift shall require continuous manual pressure and shall not allow an improper lift sequencing when the lift platform is occupied.
- (6) The lift shall incorporate a method of deploying, lowering to ground level with a lift occupant, and raising and stowing the empty lift if the power to the lift fails.
- (7) No part of the lift platform shall move at a rate exceeding 150 mm/second during lowering and lifting an occupant, and shall not exceed 600 mm/second during deploying or stowing (except if the lift is manually deployed or stowed).
- (8) The maximum lift platform horizontal and vertical acceleration when occupied shall be 0.3 g.
- (9) The lift platform shall be equipped with barriers to prevent any of the wheels of a wheelchair from rolling off the lift platform during its operation.
- (10) A movable barrier or inherent design feature shall prevent a wheelchair from rolling off the edge closest to the vehicle until the lift is in its fully raised position.
- (11) Each side of the lift platform which extends beyond the vehicle in its raised position shall have a barrier a minimum 25 mm high. Such barriers shall not interfere with manoeuvring into or out of the aisle.
- (12) The loading-edge barrier (outer barrier) which functions as a loading ramp when the lift is at ground level, shall be sufficient when raised or closed, or a supplementary system shall be provided, to prevent a power wheelchair from riding over or defeating it.

| | | | |
|---|--|--------------------|------------------|
|  OTIF | Uniform Technical Prescription | | UTP PRM |
| | Accessibility for persons with disabilities and persons with reduced mobility | | Page 60 of 112 |
| Status: PROPOSAL | | TECH-25004 Annex 1 | Original: EN |
| | | | Date: 24.02.2025 |

- (13) The lift shall permit both inboard and outboard orientation of the wheelchair user.
- (14) The lift shall be provided with self-contrasting markings.

6. ASSESSMENT OF CONFORMITY AND/OR SUITABILITY FOR USE

Modules for the

assessment procedures for the verification of elements of construction are described in the UTP GEN-D¹⁶.

procedures for assessment of conformity, suitability for use and EC verification are described in the Commission Decision 2010/713/EU¹⁷.

6.1 Interoperability constituents (IC)

6.1.1 Conformity assessment

In accordance with UTP GEN-D, [the law applicable in the Contracting States may require the mandatory that ICs be assessed separately from the subsystem assessment of ICs. If not required by the Contracting State, separate assessment of ICs may be carried out on a voluntary basis.](#)

~~In the case of separate IC assessment, the manufacturer bears full responsibility for the UTP compliance of the product within its specified area of use.~~

~~In case of separate~~ [If an IC is assessed separately from the subsystem](#) ~~ment~~, the assessment

shall be ~~in accordance~~ [ing to with](#) the prescribed module(s) of that particular constituent specified in point 6.1.2 of this UTP.

An EC declaration of conformity or suitability for use, in accordance with Article [9\(2\) and Article 10\(1\) of Directive \(EU\) 2016/797-13\(1\) and Annex IV of Directive 2008/57/EC](#), shall be drawn up by the manufacturer or his authorised representative established in the Union before placing an interoperability constituent on the market.

The ~~€~~conformity ~~A~~assessment of an ~~I~~interoperability ~~€~~constituent

6.1.2 Application of modules

Assessment procedures (modules) for the verification of elements of construction.

The modules for the EC certification of conformity of interoperability constituents

are listed in the table below:

¹⁶ ~~Assessment procedures (modules) – General Provisions, UTP, APTU (A 94 01D/3.2011)~~

¹⁷ Commission Decision 2010/713/EU of 9 November 2010 on modules for the procedures for assessment of conformity, suitability for use and EC verification to be used in the technical specifications for interoperability adopted under Directive 2008/57/EC of the European Parliament and of the Council ~~(notified under document C(2010) 7582) (OJ L 319, 4.12.2010, p. 1–52)~~

| | | | |
|---|--|--------------------|------------------|
|  OTIF | Uniform Technical Prescription | | UTP PRM |
| | Accessibility for persons with disabilities and persons with reduced mobility | | Page 61 of 112 |
| Status: PROPOSAL | | TECH-25004 Annex 1 | Original: EN |
| | | | Date: 24.02.2025 |

Table 14: Assessment procedures (modules) for the verification of elements of construction.

Table 14: Modules for EC certification of conformity of interoperability constituents

| | | |
|------------|---|---------------------|
| Module CA | Internal production control | |
| Module CA1 | Internal production control plus product verification by individual examination | |
| Module CA2 | Internal production control plus product verification at random intervals | |
| Module CB | Type examination | EC-Type examination |
| Module CC | Conformity to type based on internal production control | |
| Module CD | Conformity to type based on quality management system of the production process | |
| Module CF | Conformity to type based on product verification | |
| Module CH | Conformity based on full quality management system | |
| Module CH1 | Conformity based on full quality management system plus design examination | |
| Module CV | Type validation by in service experience (Suitability for use) | |

In the case of separate IC assessment, the manufacturer

The manufacturer or his authorised representative established within the Union

shall choose one of the modules or module combinations indicated in the following table for the constituent to be assessed:

Table 15: Combination of modules for assessment procedures (modules) for the verification of elements of construction. | *EC certification of conformity of interoperability constituents*

| | | | |
|---|--|--------------------|------------------|
|  OTIF | Uniform Technical Prescription | | UTP PRM |
| | Accessibility for persons with disabilities and persons with reduced mobility | | Page 62 of 112 |
| Status: PROPOSAL | | TECH-25004 Annex 1 | Original: EN |
| | | | Date: 24.02.2025 |

| Point of this UTP/Annex | Constituents to be assessed | <u>Modules</u> | | | | | | |
|------------------------------|---------------------------------------|------------------|--|----------------------|----------------------|----------------------|----------------------------------|-------------------|
| | | Module CA | Module CA1 or CA2*¹⁸ | Module CB +CC | Module CB +CD | Module CB +CF | Module CH*^{17,8} | Module CH1 |
| 5.3.1.1 | Displays | | ✗ | ✗ | ✗ | | ✗ | ✗ |
| 5.3.1.2 and 5.3.1.3 | Platform ramps and platform lifts | | X | | X | X | X | X |
| 5.3.2.1 | Interface of door control device | X | | X | | | X | |
| 5.3.2.2, 5.3.2.3 and 5.3.2.4 | Toilet modules | | X | X | X | | X | X |
| 5.3.2.5 | Baby nappy changing table | X | | X | | | X | |
| 5.3.2.6 | Call for aid devices | X | | X | | | X | |
| 5.3.2.7 | Internal and external displays | | ✗ | ✗ | ✗ | | ✗ | ✗ |
| 5.3.2.8 to 5.3.2.10 | Boarding devices | | X | | X | X | X | X |

(*) Modules CA1, CA2 or CH may be used only in the case of products manufactured in accordance with a design developed and already used to place products on the market before the application of relevant TSIs applicable to those products, provided that the manufacturer demonstrates to the notified body that design review and type examination were performed for previous applications under comparable conditions, and are in conformity with the requirements of this TSI; this demonstration shall be documented, and is considered as providing the

¹⁸ Modules CA1, CA2 or CH may be used only in the case of products manufactured in accordance with a design developed and already used to place products on the market before the application of relevant UTPs applicable to those products, provided that the manufacturer demonstrates to the assessing entity that design review and type examination were performed for previous applications under comparable conditions, and are in conformity with the requirements of this UTP; this demonstration shall be documented, and is considered as providing the same level of proof as module CB or design examination in accordance with module CH1.

| | | | |
|---|--|--------------------|------------------|
|  OTIF | Uniform Technical Prescription | | UTP PRM |
| | Accessibility for persons with disabilities and persons with reduced mobility | | Page 63 of 112 |
| Status: PROPOSAL | | TECH-25004 Annex 1 | Original: EN |
| | | | Date: 24.02.2025 |

same level of proof as module CB or design examination ~~in accordance~~^{ing to} ~~with~~ module CH1.

Where a particular procedure shall be used for the assessment, this is specified in the point 6.1.3.

6.1.3 Particular assessment procedures

6.1.3.1 Universal Toilet Module

The space inside the toilet compartment enabling a wheelchair as defined in ~~a~~Appendix M to be manoeuvred to a position allowing both a lateral and a diagonal transfer of the wheelchair occupant to the toilet seat shall be assessed using the method A described in the specification referenced in Appendix A, index [9].

Alternatively, where method A cannot be used, it is allowed to utilize method B described in the specification referenced in Appendix A, index [9]. This allowance is only provided for in the following cases:

- vehicles where the available floor width is narrower than 2400 mm,
- existing rolling stock when it is renewed or upgraded,

6.1.3.2 Toilet Module and Universal Toilet Module

When a toilet module or a universal toilet module is not built as an independent compartment, its characteristics can be assessed at subsystem level.

6.2 Subsystems

6.2.1 Verification of conformity¹⁹

OTIF verification (general)

The OTIF procedure for granting technical certificates is set out in ATMF Article 10.

EC verification (general)

The EC verification procedures to be applied to the subsystems are described in Article 15 of Directive (EU) 2016/797 and Annex IV to that Directive~~8 and Annex VI of Directive 2008/57/EC~~.

The UTP verification procedure shall be performed ~~in accordance with~~^{ing to} the prescribed module(s) specified in point 6.2.2 of this UTP.

For the infrastructure subsystem, if the applicant demonstrates that tests or assessments of a subsystem or parts of a subsystem are the same or have been successful for previous applications of a design, the assessing entity shall consider the results of the~~se~~ tests and assessments for the ~~OTIF~~ verification.

For the infrastructure subsystem, the objective of inspection by an assessing entity is to ensure that the requirements of the UTP are fulfilled. The inspection is performed as a visual examination; in case of

¹⁹ The title of point 6.2.1 of the TSI is “EC verification (general)”

| | | | |
|---|--|--------------------|------------------|
|  OTIF | Uniform Technical Prescription | | UTP PRM |
| | Accessibility for persons with disabilities and persons with reduced mobility | | Page 64 of 112 |
| Status: PROPOSAL | | TECH-25004 Annex 1 | Original: EN |
| | | | Date: 24.02.2025 |

doubt, for the values verification, the assessing entity can ask the applicant to perform measurements. In case different methods are possible (e.g. for contrast), the measurement method shall be the one used by the applicant.

The approval process and the contents of the assessment shall be ~~agreed~~**defined** between the applicant and assessing entity ~~in accordance with~~**ing to** the requirements ~~set out~~**defined** in this UTP ~~and in conformance with the rules set out in section 7 of this UTP.~~

6.2.2 Assessment procedures for the verification of subsystems (modules)

The modules for the assessment procedures for the verification of subsystems are listed in the table below:

~~assessment procedures for the verification of subsystems are listed in the table below:~~

Table 16: Modules for the assessment procedures for the verification of subsystems

| | |
|-------------------------|--|
| Module SB | OTIF Type examination |
| Module SD | Quality management system of the production process |
| Module SF | Verification based on product verification |
| Module SG ²⁰ | reserved |
| Module SH1 | Verification based on full quality management system plus design examination |

The applicant shall choose one of the modules or module combinations indicated in Table 17.

Table 17: Combination of Modules for the assessment procedures for the verification of subsystems

| Subsystem to be assessed | <u>Modules</u> | | | |
|--------------------------|----------------------------|----------------------------|-------------------------|--------------------------|
| | Module SB+SD | Module SB+SF | Module SG | Module SH1 |
| Rolling Stock Subsystem | X | X | | X |
| Infrastructure Subsystem | | | X | X |

²⁰ Application of this UTP for the infrastructure subsystem is voluntary so there is no module SG in COTIF describing the assessment procedure for the verification of infrastructure subsystem.

| | | | |
|---|--|--------------------|------------------|
|  OTIF | Uniform Technical Prescription | | UTP PRM |
| | Accessibility for persons with disabilities and persons with reduced mobility | | Page 65 of 112 |
| Status: PROPOSAL | | TECH-25004 Annex 1 | Original: EN |
| | | | Date: 24.02.2025 |

The characteristics of the subsystem to be assessed during the relevant phases are indicated in appendix E to this UTP, Table E.1 for Infrastructure subsystem and Table E.2 for **R**olling **S**tock subsystem. The applicant shall confirm that

Rolling **S**tock subsystem (mandatory) and/or the **I**nfrastructure subsystem (voluntary) | each subsystem produced complies with the type.

6.2.3 Particular assessment procedures

6.2.3.1 Wheelchair transfer seat

The assessment of the requirement for the provision of transfer seats shall only consist in verifying that they are present and equipped with movable armrests. In particular the method of transfer shall not be assessed.

6.2.3.2 Step position for vehicle access and egress

This requirement shall be validated by calculation using the nominal values of the construction drawing of the vehicle and the nominal values of the relevant platform or platforms where the rolling stock is intended to stop. The outer end of the floor at the passenger access door shall be considered as a step.

6.2.3.3 [Assessment of contrast for the rolling stock subsystem](#)

[Assessment of contrast for the rolling stock subsystem shall be performed in accordance with the specification referenced in Appendix A, Index \[18\].](#)

6.2.4 Technical solutions giving presumption of conformity at design stage

With regard to this UTP, the infrastructure subsystem can be considered as an assembly made of a succession of recurring subcomponents such as:

- Parking facilities,
- Doors and entrances, transparent obstacles with their marking,
- Tactile walking surface indicators, tactile information along obstacle-free routes,
- Ramps and stairs with handrails,
- Mounting and highlighting of furniture,
- Ticketing or information counters,
- Ticket vending and control machines,
- Visual information: signposting, pictograms, dynamic information,
- Platforms, including ends and edges, shelters and waiting areas when provided,
- Level track crossings.

For those subcomponents of the infrastructure subsystem, presumption of conformity may be assessed at design stage prior to and independently from any specific project. An intermediate statement of verification (ISV) shall be issued by an Assessing entity at design stage.

| | | | |
|---|--|--------------------|------------------|
|  OTIF | Uniform Technical Prescription | | UTP PRM |
| | Accessibility for persons with disabilities and persons with reduced mobility | | Page 66 of 112 |
| Status: PROPOSAL | | TECH-25004 Annex 1 | Original: EN |
| | | | Date: 24.02.2025 |

6.2.5 Assessment of maintenance

The applicant for assessment

In accordance with Article 15(4) of Directive (EU) 2016/797, the applicant

~~The Assessing Entity~~ shall be responsible for compiling the technical file, containing the documentation requested for operation and maintenance.

The Assessing Entity shall verify only that the documentation requested for operation and maintenance, as defined in point 4.5 of this UTP, is provided. The Assessing Entity is not required to verify the information contained in the documentation provided.

6.2.6 Assessment of operational rules

The railway undertaking is responsible for the safe operation of its trains (ATMF Article 6 § 2), i.e. it shall ensure that all safety-related on-train equipment is in a fully functional state and that the train is safe to run.

In conformity with Articles 10 and 12 of Directive (EU) 2016/798~~11 of Directive 2004/49/EC~~, railway undertakings and infrastructure managers must demonstrate compliance with the operational requirements of this TSI within their safety management system when applying for any new or amended safety certificate or safety authorisation.

~~For the purpose of this UTP, the Assessing Entity shall not verify any operational rule, even if they are listed in point 4.4.~~

6.2.7 Assessment of units intended to be used in general operation

When ~~R~~olling ~~S~~tock is supplied as individual vehicles, rather than in fixed units, such vehicles shall be assessed against the relevant points of this UTP, accepting that not every such vehicle will have wheelchair spaces, wheelchair accessible facilities or a universal toilet.

The area of use in terms of type of ~~R~~olling stock which, coupled with the unit to be assessed, ensures that the train is fully compliant with the UTP is not verified by the Assessing Entity.

After such a unit has received ~~the authorisation to be placed in service,~~

an admission to operation in international traffic

the authorisation to be placed on the market,

it is the responsibility of the ~~R~~ailway ~~U~~ndertaking to make sure, when forming the train with other compatible vehicles, that point 4.2 of this UTP is complied with at train level.

in accordance with~~ing to~~ the rules defined in point 4.2.2.5 of the OPE TSI (train composition).

| | | | |
|---|--|--------------------|------------------|
|  OTIF | Uniform Technical Prescription | | UTP PRM |
| | Accessibility for persons with disabilities and persons with reduced mobility | | Page 67 of 112 |
| Status: PROPOSAL | | TECH-25004 Annex 1 | Original: EN |
| | | | Date: 24.02.2025 |

7. IMPLEMENTATION OF THE UTP

7.1 Application of this UTP to new infrastructure and rolling stock

7.1.1 New Infrastructure

The application of infrastructure related parameters of this UTP is ~~voluntary, but is recommended~~ optional.

This TSI is applicable to all new stations in its scope.

It is not mandatory to apply this TSI to new stations which have already been granted a building permit or which are subject to a contract for major construction works that is either already signed or in the final phase of tendering procedure at the date of application of this TSI.

~~This UTP is applicable to all new stations in its scope.~~

~~This UTP does not apply to new stations which have already been granted a building permit or which are subject to a contract for construction works that is either already signed or under final phase of tendering procedure at the date of application of this~~

~~UTP.~~

~~TSI. Anyhow~~ However, an earlier version of this TSI, in such cases, PRM TSI 2008²¹ has to must be applied within its defined scope. ~~For those station projects, where PRM TSI 2008 will have to be applied, it is permissible (but not mandatory) to use the revised version, either totally or for particular sections; in case of application limited to particular sections, the applicant has to justify and document that applicable requirements remain consistent, and this has to~~ The consistence of applicable requirements of partial application of different versions of this TSI to particular sections of the station must be justified by the applicant and approved certified by the notified body.

Where stations which were closed for a long time to passenger service are put in service again, this may be treated as renewal or upgrade in accordance with ~~ing to~~ point 7.2.

In all cases of construction of a new station, the ~~S~~ station M ~~anager~~ anager or planning entity shall should organise a ~~of with~~ consultation of the entities in charge of the management of the neighbourhood, in order to enable as far as possible the accessibility requirements to be met not only in the station, but also for the access to the station. In the case of multimodal stations, other transport authorities ~~shall~~ should also be consulted for access to and from the railway and to and from other modes of transport.

²¹ ~~Commission Decision of 21 December 2007 concerning the technical specification of interoperability relating to 'persons with reduced mobility' in the trans-European conventional and high-speed rail system (OJ L 64, 7.3.2008, p. 72).~~

| | | | |
|---|--|--------------------|------------------|
|  OTIF | Uniform Technical Prescription | | UTP PRM |
| | Accessibility for persons with disabilities and persons with reduced mobility | | Page 68 of 112 |
| Status: PROPOSAL | | TECH-25004 Annex 1 | Original: EN |
| | | | Date: 24.02.2025 |

7.1.2 New Rolling Stock

- | | |
|--|---|
| <p>(1) This UTP is applicable to to all units of rolling stock in its the scope for which of the UTP LOC&PAS applies.</p> | <p>This TSI is applicable to all units of rolling stock in its scope which are placed on the market in service after 28 September 2023 the date of application of this TSI, except where the points 7.1.1.2 “Application to ongoing projects <u>Transition phase</u>” and 7.1.3.1 (“Rolling stock subsystem”) of the LOC&PAS TSI applies.</p> |
| <p>(2) <u>Compliance with earlier versions of the UTP PRM</u></p> <p><u>is deemed equivalent to compliance with this UTP, except for the changes listed in Appendix P.</u></p> | <p><u>Compliance with this Annex in its version applicable before 28 September 2023</u></p> |
| <p>(3) <u>The rules related to the type or design examination certificates for the rolling stock subsystem and the associated interoperability constituents shall be as specified in point 7.1.3 of the UTP LOC&PAS.</u></p> | |

7.2 Application of this UTP to existing infrastructure and rolling stock

7.2.1 Steps of the gradual transition to the target system

This UTP applies to rolling stock units when they are renewed or upgraded.

~~This~~

~~This UTP is not mandatory for the infrastructure subsystem and even when applied.~~

This TSI does not apply to renewed or upgraded stations which have already been granted a building permit or which are subject to a contract for construction works that is either already signed or under final phase of tendering procedure at the date of application of this UTP.

~~does not apply to renewed or upgraded stations which have already been granted a building permit or which are subject to a contract for construction works that is either already signed or under final phase of tendering procedure at the date of application of this~~

~~UTP.~~

~~TSI.~~

~~This~~

~~UTP~~

~~TSI~~

This UTP does not apply to renewed or upgraded rolling stock which are subject to a contract already signed or under final phase of tendering procedure at the date of application of this UTP.

~~UTP. If Contracting States apply it on a voluntary basis for the infrastructure subsystem, f or the existing~~

TSI. For the existing infrastructure and

the existing infrastructure and Rolling Stock, the overarching aim of the UTP is to achieve compliance with the UTP through the identification and progressive elimination of existing obstacles to accessibility.

| | | | |
|---|--|--------------------|------------------|
|  OTIF | Uniform Technical Prescription | | UTP PRM |
| | Accessibility for persons with disabilities and persons with reduced mobility | | Page 69 of 112 |
| Status: PROPOSAL | | TECH-25004 Annex 1 | Original: EN |
| | | | Date: 24.02.2025 |

~~UTP~~ | ~~TSI~~

~~is to achieve compliance with the~~

~~UTP~~ | ~~TSI~~

~~through the identification and progressive elimination of existing obstacles to accessibility.~~

Member States ensure that inventories of assets are organized and adopt implementation plans in order to achieve the aim of this Regulation.

7.2.1.1 Inventory of assets — infrastructure

The requirement in this clause and its sub-clauses 7.2.1.1.1 to 7.2.1.1.4, including Appendix O, relates to specifying the characteristics of the inventory of assets, including functional and technical architecture, rules for data input and consultations and rules for self-assessment and designation of the entities responsible for data provision.

Compliance with this clause in non-EU Contracting States is recommended but not mandatory, as the application of this UTP to the infrastructure subsystem is not mandatory.

7.2.1.1.1 *Functional and technical architecture*

The functions of the inventory of assets consist of:

- (1) identifying the existing obstacles and barriers to accessibility;
- (2) providing practical information to users;
- (3) monitoring and evaluating progress on accessibility.

There are no equivalent provisions in force in COTIF, so it is recommended that Contracting States which do not apply the EU regulation should implement equivalent national rules.

The architecture for the exchange of accessibility data is provided for in Regulation (EU) No 454/2011 (TAP TSI).

[The specifications referenced in Appendix A, Indexes \[21\] and \[22\] shall apply to the formatting and exchange of accessibility data.](#)

~~The following standards shall apply for the formatting and exchange of accessibility data:~~

- ~~(1) CEN/TS 16614 1:2014 Public transport — Network and Timetable Exchange (NeTEx) — Part 1: Public transport network topology exchange format 2014-05-14~~
- ~~(2) EN 12896 1:2016 Public transport. Reference data model. Common concepts (Transmodel)~~

For the intended particular usage, a harmonised specific transmodel profile as is provided for in the technical documents referred to in Appendix O, index 1.

| | | | |
|---|--|--------------------|------------------|
|  OTIF | Uniform Technical Prescription | | UTP PRM |
| | Accessibility for persons with disabilities and persons with reduced mobility | | Page 70 of 112 |
| Status: PROPOSAL | | TECH-25004 Annex 1 | Original: EN |
| | | | Date: 24.02.2025 |

7.2.1.1.2 Rules for the input and self-assessment of accessibility data

{(reserved)}

The rules for the input and self-assessment of accessibility data shall be the following:

- (1) entities that collect the accessibility data relative to assets need not be independent from the daily management of those assets;
- (2) during the first collection of accessibility data pursuant to the entry into force of Commission Implementing Regulation (EU) 2019/772²², the state of conformity of stations to this TSI may be inventoried as unassessed;
- (3) where a station, or elements thereof, undergoes an upgrade, renewal work or any type of work foreseen by a national implementation plan for this TSI, the corresponding accessibility data shall be updated, including the state of conformity to this TSI, where relevant;
- (4) the state of conformity to this TSI may be updated on the basis of an ISV as described in point 6.2.4 of this TSI;
- (5) the working order of the equipment does not need to be inventoried.

A data collection tool, the operating modes of which are described in the technical documents referred to in Appendix O, index 2, shall be made available by the Commission.

Alternatively, where structured accessibility data exist and may be converted to the harmonised profile, those data may be transferred after conversion. The methodology for the conversion of existing accessibility data and the communication protocol are provided for in the technical documents referred to in Appendix O, index 3.

²² Commission Implementing Regulation (EU) 2019/772 of 16 May 2019 amending Commission Regulation (EU) No 1300/2014 as regards inventory of assets with a view to identifying barriers to accessibility, providing information to users and monitoring and evaluating progress on accessibility ~~(OJ L 139 I, 27.5.2019, p. 1)~~.

| | | | |
|---|--|--------------------|------------------|
|  OTIF | Uniform Technical Prescription | | UTP PRM |
| | Accessibility for persons with disabilities and persons with reduced mobility | | Page 71 of 112 |
| Status: PROPOSAL | | TECH-25004 Annex 1 | Original: EN |
| | | | Date: 24.02.2025 |

7.2.1.1.3 Rules for consultation

{reserved}

From the ERSAD²³:

- (1) the public shall be able to access information from a public website hosted by the European Union Agency for Railways;
- (2) registered national authorities shall be able to retrieve all accessibility data that are relevant to the Member State;
- (3) the Commission and the Agency shall be able to retrieve all accessibility data.

~~The ERSAD database hosted by the Agency shall not be linked to other database(s).~~

7.2.1.1.4 Rules for the management of user feedback

{reserved}

Feedback from users may take the form of:

- (1) institutional feedback from users associations, including organisations representing persons with disabilities: existing structures may be used as long as they include representatives from organisations of persons with disabilities and persons with reduced mobility and reflect the situation at an appropriate level, not necessarily at a national level. The procedure for giving user feedback shall be organised so as to permit the participation of those organisations on an equal basis;
- (2) individual feedback: website visitors shall be provided with the possibility to report incorrect information about accessibility data regarding a particular station and get an acknowledgement that their comment has been received.

In both situations, the feedback from users shall be adequately considered by the entity(ies) responsible for collecting, maintaining and exchanging the data.

²³ European Railway Stations Accessibility Database (ERSAD)

| | | | |
|---|--|--------------------|------------------|
|  OTIF | Uniform Technical Prescription | | UTP PRM |
| | Accessibility for persons with disabilities and persons with reduced mobility | | Page 72 of 112 |
| Status: PROPOSAL | | TECH-25004 Annex 1 | Original: EN |
| | | | Date: 24.02.2025 |

7.2.2 Application of this UTP to existing Infrastructure

For Infrastructure, the conformity with this

UTP is optional, ~~voluntary~~

TSI is mandatory for those parts that are renewed or upgraded. However, the UTP recognizes that, due to the characteristics of the inherited railway system, compliance of existing infrastructure may be achieved through a gradual improvement of accessibility.

In addition to this gradual approach, the target system for existing infrastructure permits the following exceptions:

- In case an obstacle free route is created from existing footbridges, stairways and subways, including doors, lifts and ticket control machines, compliance with requirements related to dimensions of those in respect of width is not mandatory.
- Compliance with requirements related to the minimum width of the platform is not mandatory for existing stations if the cause of non-compliance is the presence of certain platform obstacles (e.g. structural columns, stairwells, lifts etc.) or existing tracks that are unlikely to be moveable.
- Where an existing station, or a part of it, is a recognised historic building and is protected by National Law, it is allowed to adapt the requirements of this UTP in order not to infringe the National law for the protection of the building.

~~for those parts that are renewed or upgraded. However, the~~

~~UTP~~

~~TSI~~

~~recognizes that, due to the characteristics of the inherited Railway system, compliance of existing infrastructure may be achieved through a gradual improvement of accessibility.~~

~~In addition to this gradual approach, the target system for existing infrastructure permits the following exceptions:~~

- ~~— In case an obstacle free route is created from existing footbridges, stairways and subways, including doors, lifts and ticket control machines, compliance with requirements related to dimensions of those in respect of width is not mandatory.~~

| | | | |
|---|--|--------------------|------------------|
|  OTIF | Uniform Technical Prescription | | UTP PRM |
| | Accessibility for persons with disabilities and persons with reduced mobility | | Page 73 of 112 |
| Status: PROPOSAL | | TECH-25004 Annex 1 | Original: EN |
| | | | Date: 24.02.2025 |

- ~~— Compliance with requirements related to the minimum width of the platform is not mandatory for existing stations if the cause of non-compliance is the presence of certain platform obstacles (e.g. structural columns, stairwells, lifts etc.) or existing tracks that are unlikely to be moveable.~~
- ~~- Where an existing station, or a part of it, is a recognised historic building and is protected by National Law, it is allowed to adapt the requirements of this UTP in order not to infringe the National law for the protection of the building.~~

7.2.3 Application of this UTP to ~~existing R~~olling ~~S~~tock in operation or to an existing rolling stock type

~~For Rolling Stock, the conformity with this UTP, for those parts that are renewed or upgraded, shall be as described in appendix F.~~

- (1) The rules for managing changes to rolling stock in operation or to an existing rolling stock type shall be as specified in point 7.1.2 of the UTP LOC&PAS and in Appendix F to this UTP.
- (2) If the applicant wishes to extend the area of use of a vehicle that has already been admitted to operation, it shall apply the rules as prescribed in point 7.1.4 of the UTP LOC&PAS.

| |
|---|
| <u>The rules for the extension of the area of use for existing rolling stock in operation before 19 July 2010 or having an authorisation in accordance with Directive 2008/57/EC shall be as specified in point 7.1.4 of the LOC&PAS TSI.</u> |
|---|

7.3 Specific cases

7.3.1 General

The specific cases, as listed in the following points 7.3-2, describe special provisions that are needed and authorised on particular networks of each Contracting State.

~~Contracting State:~~

~~The specific cases for Member States of the European Union are those which are included in the TSI PRM.~~

~~Specific cases which apply to the Great Britain²⁴ network of the United Kingdom are also set out in the TSI; they are therefore in full width text.~~

~~Member State:~~

These specific cases are classified as:

- “P” cases: “permanent” cases.
- “T” cases: “temporary” cases, where it is planned that the target system is reached in the future.

²⁴ ~~Specific cases which apply on the Northern Ireland network of the United Kingdom are set out in the TSI, as these are harmonised with the network of the Republic of Ireland. Specific cases which apply to the Channel Tunnel are set out in the TSI.~~

| | | | |
|---|--|--------------------|------------------|
|  OTIF | Uniform Technical Prescription | | UTP PRM |
| | Accessibility for persons with disabilities and persons with reduced mobility | | Page 74 of 112 |
| Status: PROPOSAL | | TECH-25004 Annex 1 | Original: EN |
| | | | Date: 24.02.2025 |

7.3.2 List of specific cases

~~7.3.2.1 Wheelchair Boarding (4.4.1. and 4.4.2.)~~

~~Specific Case Switzerland (“P”)~~

~~This specific case applies to new rolling stock.~~

~~Wheelchair boarding: At least one door area per train set shall be designed permitting self-depending access for persons with reduced mobility. Platform height: 550 mm over rail level.~~

~~Exceptions may be granted on the basis of the proportionality principle and in accordance with the applicable national rule.~~

~~7.3.2.2~~ 7.3.2.1 Clearways (point 4.2.2.6)

Specific case United Kingdom for Great Britain (“P”)

For reasons of restricted structure gauge, track curvature and consequent restricted vehicle width, it is permissible for clause 4.2.2.6 (1st bullet) to be complied with only for access to priority seats. This specific case does not prevent the access of TSI compliant rolling stock to the national network.

~~7.3.2.3~~ 7.3.2.2 Step position for vehicle access and egress (point 4.2.2.11)

Specific case United Kingdom for Great Britain (“P”)

For all rolling stock intended to stop, in normal operation at platforms of nominal 915 mm height.

It is permissible for passenger access steps for the vehicle to be designed to meet either the following values when the vehicle is stationary at a GB nominal 915 mm high platform.

The values of δ_h , δ_{v+} and δ_{v-} according to the following table:

Table 25 Values of δ_h , δ_{v+} and δ_{v-} for specific case United Kingdom

| | δ_h mm | δ_{v+} mm | δ_{v-} mm |
|---|---------------|------------------|------------------|
| on a straight level track | 200 | 230 | 160 |
| on a track with a curve radius of 300 m | 290 | 230 | 160 |

Or, alternatively the position set out in the national technical rules notified for this purpose.

| | | | |
|---|--|--------------------|------------------|
|  OTIF | Uniform Technical Prescription | | UTP PRM |
| | Accessibility for persons with disabilities and persons with reduced mobility | | Page 75 of 112 |
| Status: PROPOSAL | | TECH-25004 Annex 1 | Original: EN |
| | | | Date: 24.02.2025 |

Appendix A: Standards or Normative Documents Referred to in this UTP

| <u>Index</u> | <u>Characteristics to be assessed</u> | <u>UTP Point</u> | <u>Mandatory standard point</u> |
|-----------------------|---|-------------------------------|---|
| [1] | EN 81-70:2021+A1:2022 Safety rules for the construction and installation of lifts – Particular applications for passenger and goods passenger lift – Part 70: Accessibility to lifts for persons including persons with disability | | |
| [1.1] | Dimensions of the lifts | 4.2.1.2.2 (5) | 5.3.1, Table 3 |
| [1.2] | Tactile signage | 4.2.1.10 (7) | Table 4 points (c), (h), (j) and (k) |
| [2] | EN 115-1:2017 Safety of escalators and moving walks – Part 1: Construction and installation | | |
| [2.1] | Design of escalators and moving walks | 4.2.1.2.2 (6) | 5.4.1.2.2, 5.4.1.2.3, 5.2.2 |
| [3] | EN 12464-2:2014 Light and lighting – Lighting of work places – Part 2: Outdoor work places | | |
| [3.1] | Lighting on platforms | 4.2.1.9 (3) | Table 5.12, except points 5.12.16 and 5.12.19 |
| [4] | EN 12464-1:2021 Light and lighting – Lighting of work places – Part 1: Indoor work places | | |
| [4.1] | Lighting on platforms | 4.2.1.9 (3) | 61.1.2 |
| [5] | EN 60268-16:2020 Sound system equipment – Part 16: Objective rating of speech intelligibility by speech transmission index | | |
| [5.1] | Speech transmission index, stations | 4.2.1.11 (1) | Annex B |
| [5.2] | Speech transmission index, rolling stock | 4.2.2.7.4 (5) | |
| [6] | EN 13272-1:2019 Railway applications – Electrical lighting for rolling stock in public transport systems – Part 1: Heavy rail | | |
| [6.1] | Lighting in rolling stock | 4.2.2.4 (1) | 4.1.2 |
| [6.2] | Reduction of lighting (operational rule) | 4.4.2.7 | 4.1.6, 4.1.7 |
| [7] | ISO 3864-1:2011 Graphical symbols – Safety colours and safety signs – Part 1: Design principles for safety signs and safety markings | | |
| [7.1] | Safety, warning, mandatory action and prohibition signs | 4.2.2.7.2 (1) | 6, 7, 8, 9, 10, 11 |
| [8] | EN 15273-1:2013+A1:2016/AC:2017 Railway applications – Gauges - Part 1: General – Common rules for infrastructure and rolling stock | | |

| | | | |
|---|--|--------------------|------------------|
|  OTIF | Uniform Technical Prescription | | UTP PRM |
| | Accessibility for persons with disabilities and persons with reduced mobility | | Page 76 of 112 |
| Status: PROPOSAL | | TECH-25004 Annex 1 | Original: EN |
| | | | Date: 24.02.2025 |

| <u>Index</u> | <u>Characteristics to be assessed</u> | <u>UTP Point</u> | <u>Mandatory standard point</u> |
|--------------|---|--|---------------------------------|
| [8.1] | Calculation of bq_0 | 4.2.2.11.1 (2) | H.2.2 |
| [9] | EN 16585-1:2017 Railway applications – Design for PRM use – Equipment and components on board rolling stock – Part 1: Toilets | | |
| [9.1] | Assessment of the Universal Toilet Module | 6.1.3.1 | Chapter 6 |
| [9.2] | Comfortable reach range of a person using a wheelchair | 4.2.2.2 (12) | Figure B.2 |
| [10] | ISO 3864-4:2011 Graphical symbols – Safety colours and safety signs – Part 4: Colorimetric and photometric properties of safety sign materials | | |
| [10.1] | Definition of colours | 5.3.2.6 (1) | Chapter 4 |
| [11] | EN 14752:2019+A1:2021 Railway applications – Bodyside entrance systems for rolling stock | | |
| [11.1] | Boarding device mechanical strength | 5.3.2.8 (2) | 4.2.2 |
| [11.2] | Obstacle detection | 5.3.2.8 (5) | 5.4 |
| [12] | ISO 7000:2019 Graphical symbols for use on equipment – Registered symbols | | |
| [12.1] | Symbol for sign which identify wheelchair accessible areas | point N.3 of Appendix N | Symbol 0100 |
| [13] | ISO 7001:2007/Amd 4:2017 Graphical symbols – Public information symbols | | |
| [13.1] | Symbol for sign which identify wheelchair accessible areas | Point N.3 of Appendix N | Symbol PIPF 006 |
| [14] | ETSI EN 301 462:2000-03 Human Factors (HF); Symbols to identify telecommunications facilities for deaf and hard of hearing people | | |
| [14.1] | Symbol for sign indicating inductive loops | Point N.3 of Appendix N | 4.3.1.2 |
| [15] | EN 15273-2:2013+A1:2016 Railway applications – Gauges – Part 2: Rolling stock gauge | | |
| [15.1] | Specific case for Finland | 7.3.2.6 | Annex F |
| [16] | EN 16585-2:2017 Railway applications – Design for PRM use – Equipment and components on board rolling stock – Part 2: Elements for sitting, standing and moving | | |
| [16.1] | Diagrams of priority seats | 4.2.2.1.2.1 (7) 4.2.2.1.2.1 (8) | Annex A |
| [16.2] | Unidirectional seats | 4.2.2.1.2.2 (1) | Figure A.2 |

| | | | |
|---|--|--------------------|------------------|
|  OTIF | Uniform Technical Prescription | | UTP PRM |
| | Accessibility for persons with disabilities and persons with reduced mobility | | Page 77 of 112 |
| Status: PROPOSAL | | TECH-25004 Annex 1 | Original: EN |
| | | | Date: 24.02.2025 |

| <u>Index</u> | <u>Characteristics to be assessed</u> | <u>UTP Point</u> | <u>Mandatory standard point</u> |
|--------------|---|--|-------------------------------------|
| [16.3] | Facing seats arrangement | 4.2.2.1.2.3 (1) 4.2.2.1.2.3 (2) | Figures A.3 and A.4 |
| [16.4] | Diagrams of wheelchair spaces | 4.2.2.2 (4) | Figures B1, B2, B3 |
| [16.5] | Diagrams of wheelchair spaces | Appendix F | Figure 5 |
| [17] | EN 16585-3:2017 Railway applications – Design for PRM use – Equipment and components on board rolling stock – Part 3: Clearways and internal doors | | |
| [17.1] | Clearway through the vehicles | 4.2.2.6 (1) | Figure 2 |
| [17.2] | Clearway between connecting vehicles of a single trainset | 4.2.2.6 (1) | Figure 3 |
| [17.3] | Clearway to and from wheelchair accessible areas | 4.2.2.6 (1) | Figure 5 |
| [17.4] | Corridor widths for a change of direction | 4.2.2.6 (4) | Table 3 |
| [18] | EN 16584-1:2017 Railway applications – Design for PRM use – General requirements – Part 1: Contrast | | |
| [18.1] | Assessment of contrast for the rolling stock subsystem | 6.2.3.3 | Annex A, point A.1 |
| [19] | EN 16584-2:2017 Railway applications – Design for PRM use – General requirements – Part 2: Information | | |
| [19.1] | Door visible signals | 4.2.2.3.2 (11) | 5.3.3.2 (g) and (h) |
| [20] | EN 17285:2020 Railway applications – Acoustics – Measuring of door audible warnings | | |
| [20.1] | Measurement of interior door signals | App. G - G.4 | 5, 6, 7 |
| [20.2] | Measurement of exterior door signals | App. G - G.4 | 5, 6, 7 |
| [20.3] | Measurement of door finding signals | App. G - G.4 | 5, 7 |
| [21] | CEN/TS 16614-1:2020 Public transport – Network and Timetable Exchange (NeTEx) – Part 1: Public transport network topology exchange format | | |
| [21.1] | Formatting and exchange of accessibility data | 7.2.1.1.1 | All |
| [22] | EN 12896-1:2016 Public transport. Reference data model. Common concepts (Transmodel) | | |
| [22.1] | Formatting and exchange of accessibility data | 7.2.1.1.1 | All |

**OTIF**

Uniform Technical Prescription

Accessibility for persons with disabilities and persons with reduced mobility

UTP PRM

Page 78 of 112

Status: **PROPOSAL**

TECH-25004 Annex 1

Original: EN

Date: 24.02.2025

| Index | UTP / TSI | | Normative document | |
|-------|--|-----------------------|------------------------------------|--|
| | Characteristics to be assessed | Point of this Annex | Document N° | Mandatory provisions |
| 1 | Dimensions of the lifts Tactile signage | 4.2.1.2.2 4.2.1.10 | EN 81-70:2003+A1:2004 | Point 5.3.1, table 1 Annex E.4 |
| 2 | Design of escalators and moving walks | 4.2.1.2.2 | EN 115-1:2008+A1:2010 | |
| 3 | Lighting on platforms | 4.2.1.9 | EN 12464-2:2014 | Table 5.12, except ref. no 5.12.16 and 5.12.19 |
| 4 | Lighting on platforms | 4.2.1.9 | EN 12464-1:2011 | Point 5.53.1 |
| 5 | Speech transmission index, stations and rolling stock | 4.2.1.11 4.2.2.7.4 | EN 60268-16:2011 | Annex B |
| 6 | Lighting in rolling stock | 4.2.2.4 | EN 13272:2012 | Point 4.1.2 |
| 7 | Safety, warning, mandatory action and prohibition signs | 4.2.2.7.2 | ISO 3864-1:2011 | All |
| 8 | Calculation of b_{q0} | 4.2.2.11.1 | EN 15273-1:2013 | Point H.2.1.1 |
| 9 | Assessment of the Universal Toilet Module | 6.1.3.1 | TS 16635:2014 | All |
| 10 | Definition of colours | 5.3.2.6 | ISO 3864-1:2011 ISO 3864-4:2011 | Chapter 11 |
| 11 | Boarding device mechanical strength Obstacle detection | 5.3.2.8 5.3.2.8 | EN 14752:2014 | Point 4.2.2 Point 5.4 |
| 12 | Symbol for sign which identify wheelchair accessible areas | Appendix N N.3 | ISO 7000:2004 ISO 7001:2008 | Symbol 0100 symbol PIPF-006 |
| 13 | Symbol for sign indicating inductive loops | Appendix N N.3 | ETSI EN 301 462 (2000-03) | 4.3.1.2 |
| 14 | Specific case for Finland | 7.3.2.6 | EN 15273-2:2013 | Annex F |

| | | | |
|---|--|--------------------|------------------|
|  OTIF | Uniform Technical Prescription | | UTP PRM |
| | Accessibility for persons with disabilities and persons with reduced mobility | | Page 79 of 112 |
| Status: PROPOSAL | | TECH-25004 Annex 1 | Original: EN |
| | | | Date: 24.02.2025 |

Appendix B: Temporary prioritization rule for the upgrade / renewal of stations

{reserved}

When renewed or upgraded, existing stations that have a daily passenger flow of 1000 passengers or less, combined embarking and disembarking, averaged over a 12 month period are not required to have lifts or ramps where these would otherwise be necessary to provide a step free route if another station within 50 km on the same route provides a fully compliant obstacle-free route. In such circumstances the design of stations shall incorporate provision for the future installation of a lift and/or ramps to make the station accessible to all persons with disabilities and persons with reduced mobility. National Rules shall be applied for organising the transport of persons with disabilities and persons with reduced mobility by an accessible means between this non accessible station and the next accessible station on the same route.

| | | | |
|---|--|--------------------|------------------|
|  OTIF | Uniform Technical Prescription | | UTP PRM |
| | Accessibility for persons with disabilities and persons with reduced mobility | | Page 80 of 112 |
| Status: PROPOSAL | | TECH-25004 Annex 1 | Original: EN |
| | | | Date: 24.02.2025 |

Appendix C: Information to be provided in a National Implementation Plan

Not used

[reserved]

~~Context~~

- ~~— Setting the scene (facts and figures — social data — evolution of mobility needs and mobility impairments)~~
- ~~— Legislative background~~
- ~~— Methodology for the elaboration of the NIP (associations consulted, local transport authorities consulted, interface with other NIPs, etc...)~~

~~Current situation~~

- ~~— Overview of the inventories: stations~~
- ~~— Overview of the inventories: rolling stock~~
- ~~— Overview of the inventories: operational rules~~

~~Definition of a strategy~~

- ~~— Prioritization rule,~~
- ~~— Criteria according to which subsystems are treated in the Plan.~~

~~Technical and operational means~~

- ~~— Extent of the upgrade or renewal of stations and rolling stock~~
- ~~— All other works aimed at eliminating barriers to accessibility which are outside the scope of Article 20 of Directive 2008/57/EC~~
- ~~— Deployment of operational measures (assistance) to compensate the remaining lack of accessibility~~

~~Financing~~

- ~~— Cross references to contract agreements (Directive 2012/34/EU art. 30²⁵) and public service contracts (Regulation (EC) N°1370/2007²⁶)~~
- ~~— Other resources~~

~~Follow up and feedback~~

- ~~— Update of the inventory of assets and comparison with the objectives~~

²⁵ Directive 2012/34/EU of the European Parliament and of the Council of 21 November 2012 establishing a single European railway area (OJ L 342, 14.12.2012, p. 32).

²⁶ Regulation (EC) No 1370/2007 of the European Parliament and of the Council of 23 October 2007 on public passenger transport services by rail and by road and repealing Council Regulations (EEC) No 1191/69 and 1107/70 (OJ L 315, 3.12.2007, p. 1).

| | | | | |
|---|--|--------------------|--------------|---------------------------|
|  OTIF | Uniform Technical Prescription Accessibility for persons with disabilities and persons with reduced mobility | | | UTP PRM Page 81 of 112 |
| Status: PROPOSAL | | TECH-25004 Annex 1 | Original: EN | Date: 24.02.2025 |

|

| ~~Update of the plan.~~

| | | | |
|---|--|--------------------|------------------|
|  OTIF | Uniform Technical Prescription | | UTP PRM |
| | Accessibility for persons with disabilities and persons with reduced mobility | | Page 82 of 112 |
| Status: PROPOSAL | | TECH-25004 Annex 1 | Original: EN |
| | | | Date: 24.02.2025 |

Appendix D: Assessment of interoperability constituents

D.1 SCOPE

This Appendix indicates the assessment of conformity and suitability for use for interoperability constituents.

D.2 CHARACTERISTICS

The characteristics of the interoperability constituents to be assessed in the different phases of design, development and production are marked by X in Table D.1.

Table D.1 – Assessment of Interoperability Constituents.

| 1 | 2 | 3 | 4 | 5 |
|---|---|--|------------------|---|
| Interoperability Constituents and characteristics to be assessed | Assessment in the following phase | | | |
| | Design and development phase | | | Production phase |
| | Design review and /or Design examination | Review of manufacturing process | Type test | Verification of conformity to type |
| 5.3.1.1 Displays | ✘ | | ✘ | ✘ |
| 5.3.1.2 Platform ramps | X | | X | X |
| 5.3.1.3 Platform lifts | X | | X | X |
| 5.3.2.1 Interface of the door control device | X | | X | X |
| 5.3.2.2 & 5.3.2.3 Standard toilets | X | | X | X |
| 5.3.2.2 & 5.3.2.4 Universal toilets | X | | X | X |
| 5.3.2.5 Baby nappy changing unit | X | | X | X |
| 5.3.2.6 Call for aid device | X | | X | X |
| 5.3.2.7 Displays | ✘ | | ✘ | ✘ |
| 5.3.2.8 Movable step and bridging plate | X | | X | X |

| | | | | |
|---|--|--------------------|----------------|------------------|
|  OTIF | Uniform Technical Prescription | | UTP PRM | |
| | Accessibility for persons with disabilities and persons with reduced mobility | | Page 83 of 112 | |
| Status: PROPOSAL | | TECH-25004 Annex 1 | Original: EN | Date: 24.02.2025 |

| 1 | 2 | 3 | 4 | 5 |
|---|---|--|------------------|---|
| Interoperability Constituents and characteristics to be assessed | Assessment in the following phase | | | |
| | Design and development phase | | | Production phase |
| | Design review and /or Design examination | Review of manufacturing process | Type test | Verification of conformity to type |
| 5.3.2.9 On-board ramp | X | | X | X |
| 5.3.2.10 On-board lift | X | | X | X |

| | | | |
|---|--|--------------------|------------------|
|  OTIF | Uniform Technical Prescription | | UTP PRM |
| | Accessibility for persons with disabilities and persons with reduced mobility | | Page 84 of 112 |
| Status: PROPOSAL | | TECH-25004 Annex 1 | Original: EN |
| | | | Date: 24.02.2025 |

Appendix E: Assessment of the subsystems

E.1 SCOPE

This Appendix indicates the assessment of conformity of the subsystems.

E.2 CHARACTERISTICS AND MODULES

The sub-system characteristics to be assessed in the different phases of design, development and production are marked by X in Table E.1 for Infrastructure subsystem and Table E.2 for ~~R~~olling ~~S~~tock subsystem.

Table E.1 – Assessment of the Infrastructure subsystem (constructed and supplied as single entity)

| 1 | 2 | 3 |
|---|---|----------------------------|
| Characteristics to be assessed | Design and development phase | Construction phase |
| | Design review and/or design examination | Site-Inspection |
| Parking facilities for persons with disabilities and persons with reduced mobility PRM | X | (X)* |
| Obstacle-free routes | X | (X)* |
| Route identification | X | (X)* |
| Doors and entrances | X | (X)* |
| Floor surfaces | X | (X)* |
| Transparent obstacles | X | (X)* |
| Toilets | X | (X)* |
| Furniture and free-standing devices | X | (X)* |
| Ticketing / Counter or vending machine / Information counter / Ticket control machine / Turnstiles / Customer Assistance points | X | (X)* |
| Lighting | X | X |
| Visual information: signposting, pictograms, dynamic information | X | (X)* |
| Spoken information | X | X |
| Platform width and edge of platform | X | (X)* |

| | | | |
|---|--|--------------------|------------------|
|  OTIF | Uniform Technical Prescription | | UTP PRM |
| | Accessibility for persons with disabilities and persons with reduced mobility | | Page 85 of 112 |
| Status: PROPOSAL | | TECH-25004 Annex 1 | Original: EN |
| | | | Date: 24.02.2025 |

| 1 | 2 | 3 |
|---------------------------------------|--|---------------------------|
| Characteristics to be assessed | Design and development phase | Construction phase |
| | Design review and/or design examination | Site-Inspection |
| End of platform | X | (X)* |
| Level track crossing at stations | X | (X)* |

*: ~~As built drawings shall be provided or a site inspection shall be carried out when the realization differs from the design rules or drawings that were examined.~~

Table E.2 – Assessment of the ~~R~~olling ~~S~~tock subsystem (constructed and supplied as serial products)

| 1 | 2 | 3 | 4 |
|---------------------------------------|--|------------------|-------------------------|
| Characteristics to be assessed | Design and development phase | | Production phase |
| | Design review and/or design examination | Type Test | Routine Test |
| Seats | | | |
| General | X | X | |
| Priority Seats General | X | | |
| Uni-directional seats | X | X | |
| Facing seats arrangement | X | X | |
| Wheelchair spaces | X | X | |
| Doors | | | |
| General | X | X | |
| Exterior doors | X | X | |
| Interior doors | X | X | |
| Lighting | | X | |
| Toilets | X | | |
| Clearways | X | | |
| Customer Information | | | |
| General | X | X | |

| | | | |
|---|--|--------------------|------------------|
|  OTIF | Uniform Technical Prescription | | UTP PRM |
| | Accessibility for persons with disabilities and persons with reduced mobility | | Page 86 of 112 |
| Status: PROPOSAL | | TECH-25004 Annex 1 | Original: EN |
| | | | Date: 24.02.2025 |

| 1 | 2 | 3 | 4 |
|--|---|-----------|------------------|
| Characteristics to be assessed | Design and development phase | | Production phase |
| | Design review and/or design examination | Type Test | Routine Test |
| Signage, pictogram and tactile information | X | X | |
| Dynamic visual information | X | X | |
| Dynamic Audible information | X | X | |
| Height changes | X | | |
| Handrails | X | X | |
| Wheelchair Accessible sleeping accommodation | X | X | |
| Step position for vehicle access and egress | | | |
| General requirements | X | | |
| Access/egress steps | X | | <u>X</u> |
| Boarding aids | X | X | X |

| | | | |
|---|--|--------------------|------------------|
|  OTIF | Uniform Technical Prescription | | UTP PRM |
| | Accessibility for persons with disabilities and persons with reduced mobility | | Page 87 of 112 |
| Status: PROPOSAL | | TECH-25004 Annex 1 | Original: EN |
| | | | Date: 24.02.2025 |

Appendix F: Renewal or upgrade of rolling stock

Where parts of rolling stock ~~is-are~~ renewed or upgraded, ~~it-they~~ shall comply with the requirements of this UTP; compliance with the content of this UTP is not mandatory in the following cases:

Structures

Compliance is not mandatory if the work would require structural alterations to door portals (interior or external), underframes, collision pillars, vehicle bodies, vehicle over-ride protection, or more generally ~~ifs~~ the work would necessitate re-validation of the vehicle structural integrity.

Seats

Compliance with point 4.2.2.1 with regard to seat back grab handles is only mandatory if the seat structures are renewed or upgraded within an entire vehicle.

Compliance with point 4.2.2.1.2 with regard to the dimensions of priority seats and ~~their surroundings~~ is only mandatory if the seating layout is altered within an entire train and this can be achieved without reducing the existing capacity of the train. In ~~this case last circumstance~~, the maximum number of priority seats shall be provided, ~~whilst maintaining existing capacity~~.

Compliance with requirements regarding headroom above priority seating is not mandatory if the limiting factor is a luggage rack that is not being structurally altered during the renewal or upgrading work.

Wheelchair Spaces

The provision of wheelchair spaces is only required when the seating layout is altered within a complete train formation. However, if the entrance doorway, or clearways, cannot be modified to enable wheelchair access, a wheelchair space ~~does not need~~ ~~not to~~ be provided if the seating layout is altered. Wheelchair spaces created in an existing rolling stock ~~are permitted to~~ ~~may~~ be arranged ~~in accordance with the specification referenced in Appendix A, Index [16]~~ ~~to Appendix I, figure I4~~.

The provision of call for aid devices at the wheelchair positions is not mandatory if the vehicle does not have an electrical communications system that can be adapted to include such a device.

The provision of a transfer seat is only mandatory when it does not require modifying the layout of an existing wheelchair space.

Exterior doors

Compliance with requirements to define the interior position of external doorways by contrast at floor level is only mandatory when the floor covering is renewed or upgraded.

Compliance with requirements to provide door opening and closing signals is only mandatory when the door control system is renewed or upgraded.

Full compliance with requirements regarding the position and illumination of door controls is only mandatory when the door control system is renewed or upgraded and when the controls can be re-positioned without alteration to the vehicle structure or door. However, in such an event, the renewed or upgraded controls shall be installed as close as possible to the compliant position.

| | | | |
|---|--|--------------------|------------------|
|  OTIF | Uniform Technical Prescription | | UTP PRM |
| | Accessibility for persons with disabilities and persons with reduced mobility | | Page 88 of 112 |
| Status: PROPOSAL | | TECH-25004 Annex 1 | Original: EN |
| | | | Date: 24.02.2025 |

Interior doors

Compliance with the requirements for door control operation operating forces and positioning is only mandatory if the door and door mechanism and/or control is being upgraded or renewed.

Lighting

Compliance with the requirement is not required if it can be established that there is insufficient capacity in the electrical system to support additional load, or that such lighting cannot locally be accommodated without structural alterations (doorways, etc.~~...~~).

Toilets

Provision of a fully compliant universal toilet is only mandatory when existing toilets are being completely renewed or upgraded and a wheelchair space is provided, and a compliant universal toilet can be accommodated without structural alteration to the vehicle body.

The provision of call for aid devices in the universal toilet is not mandatory if the vehicle does not have an electrical communications system that can be adapted to include such a device.

Clearways

Compliance with the requirements of point 4.2.2.6 is only mandatory if the seating layout is altered within an entire vehicle and a wheelchair space is being provided.

Compliance with the requirements for clearways between connecting vehicles is only mandatory if the gangway is being renewed or upgraded.

Information

Compliance with the requirements of point 4.2.2.7 in respect of route information is not mandatory at renewal or upgrade. However, where an automated route information system is installed as part of a renewal or upgrade programme, it shall comply with the requirements of this point.

Compliance with the other parts of point 4.2.2.7 shall be mandatory whenever signage or interior finishes are renewed or upgraded.

Height Changes

Compliance with the requirements of point 4.2.2.8 is not mandatory at renewal or upgrade. ~~However, with the exception that~~ a contrasting warning band on step nosings shall be provided when tread surface materials are renewed or upgraded.

Handrails

Compliance with the requirements of point 4.2.2.9 is only mandatory where existing handrails are being renewed or upgraded.

Wheelchair ~~W~~accessible sleeping accommodation

Compliance with the requirement to provide ~~W~~wheelchair ~~A~~accessible sleeping accommodation is only mandatory when existing sleeping accommodation is being renewed or upgraded.

The provision of call for aid devices in the ~~W~~wheelchair ~~A~~accessible sleeping accommodation is not mandatory if the vehicle does not have an electrical communications system that can be adapted to include such a device.

| | | | |
|---|--|--------------------|------------------|
|  OTIF | Uniform Technical Prescription | | UTP PRM |
| | Accessibility for persons with disabilities and persons with reduced mobility | | Page 89 of 112 |
| Status: PROPOSAL | | TECH-25004 Annex 1 | Original: EN |
| | | | Date: 24.02.2025 |

Step positions, steps and boarding aids

Compliance with the requirements of points 4.2.2.11 and 4.2.2.12 is not mandatory at renewal or upgrade. However, ~~with the exception that~~ if moveable steps or other integral boarding aids are fitted, they shall comply with the relevant provisions ~~sub-clauses in of those~~ points ~~of the UTP~~.

However, if a wheelchair space in accordance with point 4.2.2.3 is created at renewal or upgrade, then it shall be mandatory to provide some form of boarding aid in accordance with point 4.4.3.

| | | | |
|---|--|--------------------|------------------|
|  OTIF | Uniform Technical Prescription | | UTP PRM |
| | Accessibility for persons with disabilities and persons with reduced mobility | | Page 90 of 112 |
| Status: PROPOSAL | | TECH-25004 Annex 1 | Original: EN |
| | | | Date: 24.02.2025 |

Appendix G: Passenger external doors audible signalswarnings

G.1 DEFINITIONS

The following terms are used in this Appendix:

f_{signal} = frequency of excitation tone

L_S = sound pressure level measured as L_{AFmax} the maximum Sound Level with “A” Frequency weighting and Fast Time weighting during the measurement period.

L_{Smax} = maximum L_{AFmax}

L_{Smin} = minimum L_{AFmax}

L_N = surrounding noise level measured as follows:

- a) frequency range energetic sum of three octave bands

$$L_N = \Sigma \left(10^{\frac{L_1}{10}} + 10^{\frac{L_2}{10}} + 10^{\frac{L_3}{10}} \right)$$

where:

$L_1 = L_{\text{oct.500 Hz}}$

$L_2 = L_{\text{oct.1000 Hz}}$

$L_3 = L_{\text{oct.2000 Hz}}$

- b) Sound Pressure level measured as an energy equivalent level of 20 s (L_{Aeq20})

G.2 DOOR OPENING AND CLOSING SIGNALS

G.2.1 Door opening signal

| | |
|-----------------------------|--|
| <u>Characteristics</u> | <u>A slow multitone pulse (up to 2 pulses per second) of 2 tones emitted sequentially</u> |
| <u>Frequencies</u> | $f_{\text{signal1}} = 2200 \text{ Hz} \pm 100 \text{ Hz}$ $f_{\text{signal2}} = 1760 \text{ Hz} \pm 100 \text{ Hz}$ |
| <u>Sound pressure level</u> | <u>Adaptive device</u> - $L_S \geq L_N + 5 \text{ dB}$ - $L_{Smax} = 70 \text{ dB} (+ 6 / - 0 \text{ dB})$ <u>Non-adaptive device</u> - $L_S = 70 \text{ dB} (+ 6 / - 0 \text{ dB})$ |

G.2.2 Door closing signal

| | |
|------------------------|--|
| <u>Characteristics</u> | <u>A fast pulsed tone (6-10 pulses per second)</u> |
| <u>Frequency</u> | $f_{\text{signal}} = 1900 \text{ Hz} \pm 100 \text{ Hz}$ |

| | | | |
|---|--|--------------------|------------------|
|  OTIF | Uniform Technical Prescription | | UTP PRM |
| | Accessibility for persons with disabilities and persons with reduced mobility | | Page 91 of 112 |
| Status: PROPOSAL | | TECH-25004 Annex 1 | Original: EN |
| | | | Date: 24.02.2025 |

| | |
|-----------------------------|---|
| <u>Sound pressure level</u> | <u>Adaptive device</u> <ul style="list-style-type: none"> - $L_S > L_N + 5 \text{ dB}$ - $L_{S\text{max}} = 70 \text{ dB} (+ 6 / - 0 \text{ dB})$ <u>Non-adaptive device</u> <ul style="list-style-type: none"> - $L_S = 70 \text{ dB} (+ 6 / - 0 \text{ dB})$ |
|-----------------------------|---|

G.3 DOOR FINDING SIGNAL

The door finding signal can be a single tone signal (in accordance with point G.3.1) or a dual tone signal (in accordance with point G.3.2). Both signal types shall be equally accepted in all Contacting States.

G.3.1 Single Tone Signal

| | |
|-----------------------------|---|
| <u>Characteristics</u> | <u>Interval of tone (rectangle), no fade in and fade out</u> <ul style="list-style-type: none"> - <u>signal impulse duration = 5 ms \pm 1 ms “on” (pure tone impulse)</u> - <u>signal time pattern of 3 to 5 pulses per second</u> |
| <u>Frequency</u> | $f_{\text{signal}} = 630 \text{ Hz} \pm 50 \text{ Hz}$ |
| <u>Sound pressure level</u> | <u>Adaptive device</u> <ul style="list-style-type: none"> - $L_S \geq L_N + 5 \text{ dB}$ - $L_{S\text{min}} = 45 \text{ dB} (\pm 2 \text{ dB})$ - $L_{S\text{max}} = 65 \text{ dB} (\pm 2 \text{ dB})$ <u>Non-adaptive device</u> <ul style="list-style-type: none"> - $L_S = 60 \text{ dB}$ |

G.3.2 Dual Tone Signal

| | |
|-----------------------------|--|
| <u>Characteristics</u> | <u>Interval of tones (signal definition)</u> <ul style="list-style-type: none"> - <u>100 ms sound pressure level fade in</u> - <u>100 ms sound first tone 550 Hz \pm 50 Hz</u> - <u>100 ms sound pressure level fade out</u> - <u>200 ms off</u> - <u>100 ms sound pressure level fade in</u> - <u>100 ms sound second tone 750 Hz \pm 50 Hz</u> - <u>100 ms sound pressure level fade out</u> - <u>900 ms off</u> - <u>signal repetition time = 1700ms</u> |
| <u>Frequencies</u> | $f_{\text{signal1}} = 550 \text{ Hz} \pm 50 \text{ Hz}$ $f_{\text{signal2}} = 750 \text{ Hz} \pm 50 \text{ Hz}$ |
| <u>Sound pressure level</u> | <u>Adaptive device</u> <ul style="list-style-type: none"> - $L_S \geq L_N + 5 \text{ dB}$ - $L_{S\text{min}} = 50 \text{ dB} (\pm 2 \text{ dB})$ - $L_{S\text{max}} = 70 \text{ dB} (\pm 2 \text{ dB})$ |

| | | | |
|---|--|--------------------|------------------|
|  OTIF | Uniform Technical Prescription | | UTP PRM |
| | Accessibility for persons with disabilities and persons with reduced mobility | | Page 92 of 112 |
| Status: PROPOSAL | | TECH-25004 Annex 1 | Original: EN |
| | | | Date: 24.02.2025 |

| | |
|--|--|
| | Non-adaptive device - $L_S = 70$ dB |
|--|--|

G.4 MEASURING POSITIONS

The microphone position for the measurements of audible door signals shall be in accordance with the specification referenced in Appendix A, Index [20]. The specification shall also be used for the microphone position of the door finding signal despite the scope of the specification excluding the door finding signal.

Measurements to demonstrate compliance shall be carried out at three door locations on a train. The door shall be fully open for the close test and fully closed for the open test.

Door opening—Characteristics

~~A slow pulse multi tone (up to 2 pulses per second) of 2 tones emitted sequential.~~

~~Frequencies~~

~~— 2200 Hz +/- 100 Hz~~

~~and:~~

~~— 1760 Hz +/- 100 Hz~~

~~Sound Pressure level~~

~~— To be provided by either:~~

~~— an adaptive audible warning device set at 5 dB $L_{Aeq,T}$ min above ambient up to a max of 70 dB $L_{Aeq,T}$ (+ 6/- 0)~~

~~— or a non adaptive device set at 70 dB $L_{Aeq,T}$ (+ 6/- 0)~~

~~— Internal measurement on the centre point of the vestibule at a height of 1.5 m above the floor level. (T = total duration of the sound event) using measurement array (horizontal and then vertical) and averaged readings.~~

~~— External measurement, 1.5 m away from the body side door centreline at 1.5 m above the platform level. (T = total duration of the sound event) using measurement array (horizontal) and averaged readings.~~

Door close—Characteristic

~~A fast pulsed tone (6-10 pulses per second)~~

~~Frequency~~

~~— 1 900 Hz +/- 100 Hz~~

~~Sound Pressure level~~

~~— To be provided by either:~~

~~— an adaptive audible warning device set at 5 dB L_{Aeq} min above ambient up to a max of 70 dB $L_{Aeq,T}$ (+ 6/- 0)~~

~~— or a non adaptive device set at 70 dB $L_{Aeq,T}$ (+ 6/- 0)~~

| | | | |
|---|--|--------------------|------------------|
|  OTIF | Uniform Technical Prescription | | UTP PRM |
| | Accessibility for persons with disabilities and persons with reduced mobility | | Page 93 of 112 |
| Status: PROPOSAL | | TECH-25004 Annex 1 | Original: EN |
| | | | Date: 24.02.2025 |

- ~~— Internal measurement on the centre point of the vestibule at a height of 1.5 m above the floor level. (T – total duration of the sound event) using measurement halo (horizontal and then vertical) and averaged readings.~~
- ~~— External measurement, 1.5 m away from the body side door centreline at 1.5 m above the platform level. (T – total duration of the sound event) using measurement halo (horizontal) and averaged readings.~~

Internal measurement method for Passenger door audible warnings (Open and Close)

Tests to be carried out in the vestibule using an averaged reading from a multiple microphone array (designed for measuring horn noise in the cab in accordance with

UTP NOI²⁷; | 2006/66/EC Noise TSI);

the array consists of 8 microphones evenly spaced around a circle of radius 250 mm.

Testing to be carried out with the array arranged horizontally (all microphones the same distance above the floor, as shown in Figure G1). The average of the readings from all 8 microphones will be used for the assessment.

Figure G1 Horizontal array set up

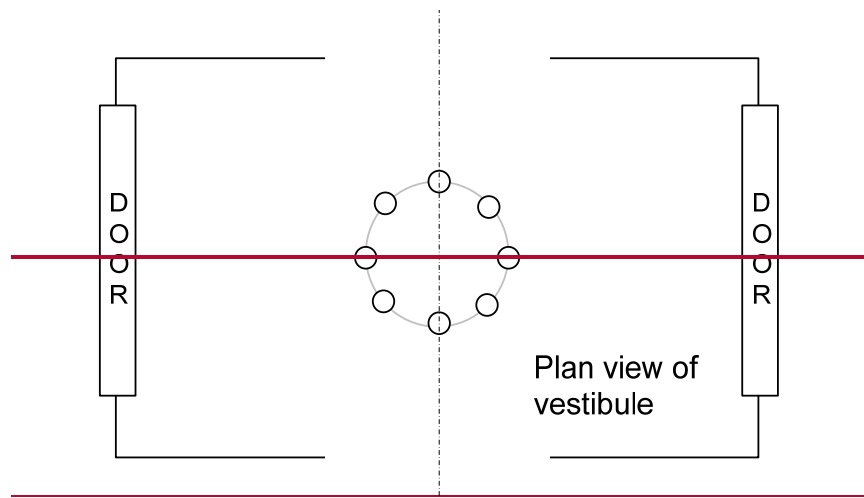

External measurement method for Passenger door audible warnings (Open and Close)

Tests to be carried out using an averaged reading from a multiple microphone array (designed for measuring horn noise in the cab in accordance with

UTP NOI; | 2006/66/EC Noise TSI);

the array consists of 8 microphones evenly spaced around a circle of radius 250 mm.

For the external test the assumed platform height should be specific to the route on which the vehicle is designed to be operated (if the operated route covers more than 1 height of platform then the lower height should be used i.e. 760 and 550 mm high platforms are on the operated route then the test will be carried out for the lower which would be 550 mm).

²⁷ ROLLING STOCK – NOISE, General Provisions, UTP NOI 2015 of 1 December 2015

| | | | |
|---|--|--------------------|------------------|
|  OTIF | Uniform Technical Prescription | | UTP PRM |
| | Accessibility for persons with disabilities and persons with reduced mobility | | Page 94 of 112 |
| Status: PROPOSAL | | TECH-25004 Annex 1 | Original: EN |
| | | | Date: 24.02.2025 |

~~Testing to be carried out with the array arranged horizontally (all microphones the same distance above the platform) The average of the readings from all 8 microphones will be used for the assessment~~

~~In case an adaptive audible warning device is used, the device shall define the surrounding noise level prior to the warning sequence. A frequency band from 500 Hz up to 5000 Hz shall be taken in consideration.~~

~~Measurements to demonstrate compliance shall be carried out at three door locations on a train.~~

~~Note: the door should be fully open for the close test and fully closed for the open test.~~

| | | | |
|---|--|--------------------|----------------------------------|
|  OTIF | Uniform Technical Prescription Accessibility for persons with disabilities and persons with reduced mobility | | UTP PRM Page 96 of 112 |
| Status: PROPOSAL | | TECH-25004 Annex 1 | Original: EN Date: 24.02.2025 |

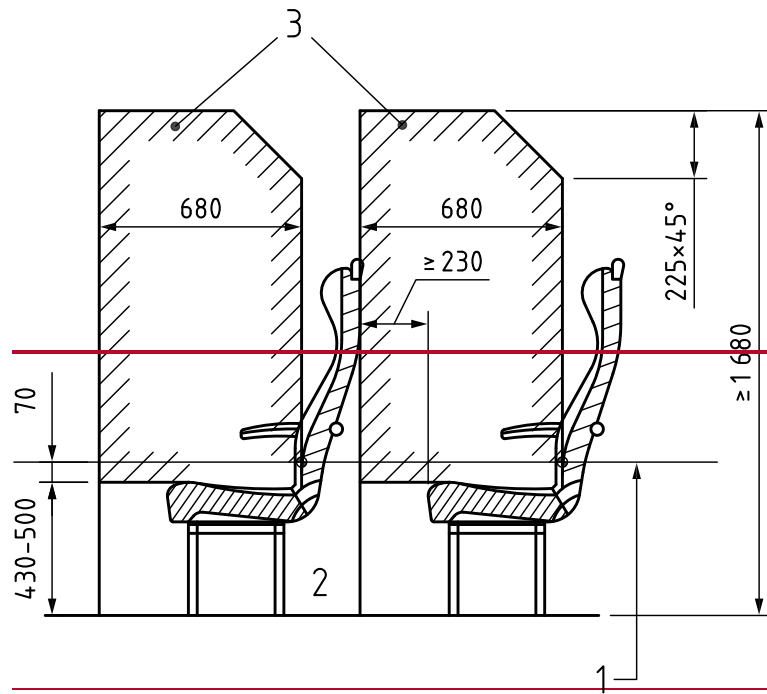
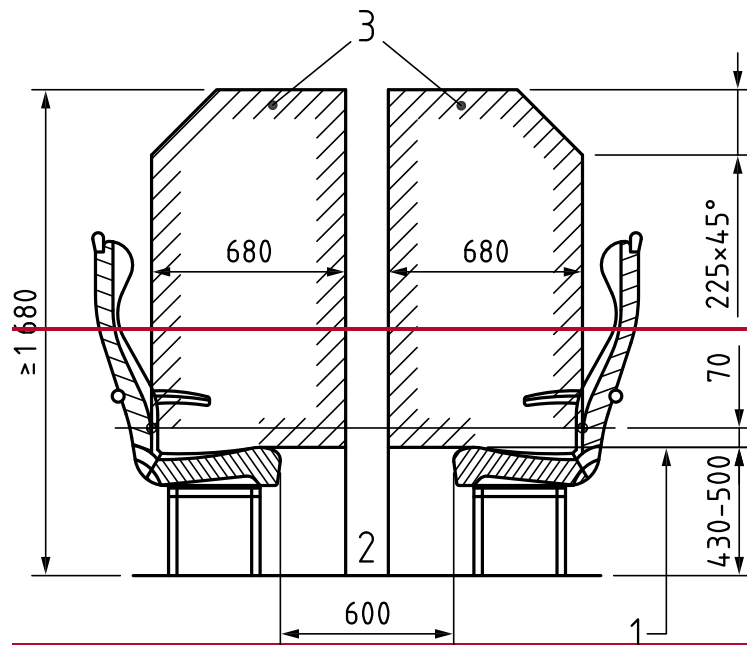

FIGURE H3 – FACING PRIORITY SEATS





| | | | |
|---|--|--------------------|------------------|
|  OTIF | Uniform Technical Prescription | | UTP PRM |
| | Accessibility for persons with disabilities and persons with reduced mobility | | Page 97 of 112 |
| Status: PROPOSAL | | TECH-25004 Annex 1 | Original: EN |
| | | | Date: 24.02.2025 |

FIGURE H4 – FACING PRIORITY SEATS WITH TABLE IN STORED POSITION

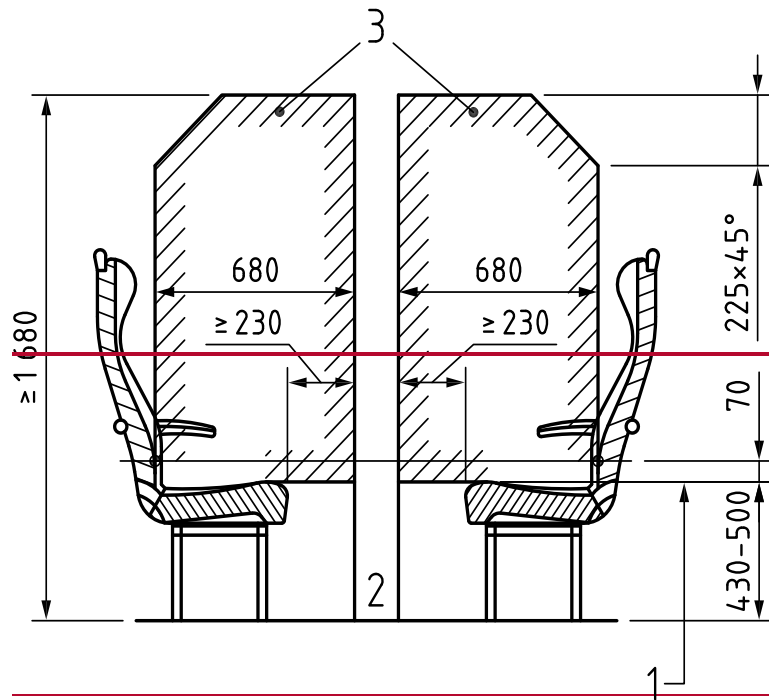

| | | | |
|---|--|--------------------|------------------|
|  OTIF | Uniform Technical Prescription | | UTP PRM |
| | Accessibility for persons with disabilities and persons with reduced mobility | | Page 98 of 112 |
| Status: PROPOSAL | | TECH-25004 Annex 1 | Original: EN |
| | | | Date: 24.02.2025 |

APPENDIX I:

not used

~~Diagrams of wheelchair spaces~~

~~Figure II—Wheelchair space in facing seating arrangement~~

~~1—STRUCTURE AT END OF WHEELCHAIR SPACE~~

~~2—FRONT EDGE OF PASSENGER SEAT CUSHION~~

~~3—WHEELCHAIR SPACE~~

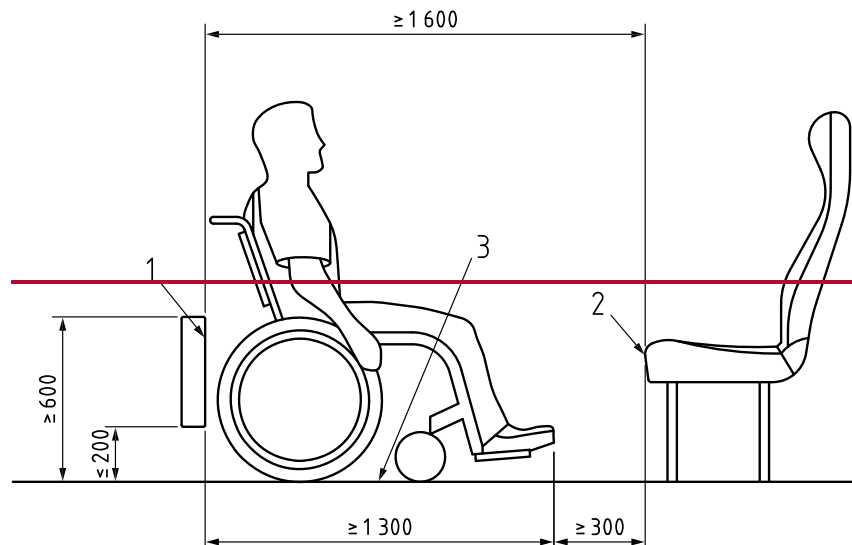

| | | | |
|---|--|--------------------|------------------|
|  OTIF | Uniform Technical Prescription | | UTP PRM |
| | Accessibility for persons with disabilities and persons with reduced mobility | | Page 99 of 112 |
| Status: PROPOSAL | | TECH-25004 Annex 1 | Original: EN |
| | | | Date: 24.02.2025 |

FIGURE 12 – WHEELCHAIR SPACE IN UNIDIRECTIONAL SEATING ARRANGEMENT

1 – STRUCTURE AT END OF WHEELCHAIR SPACE

2 – BACK OF THE FRONT PASSENGER SEAT

3 – WHEELCHAIR SPACE

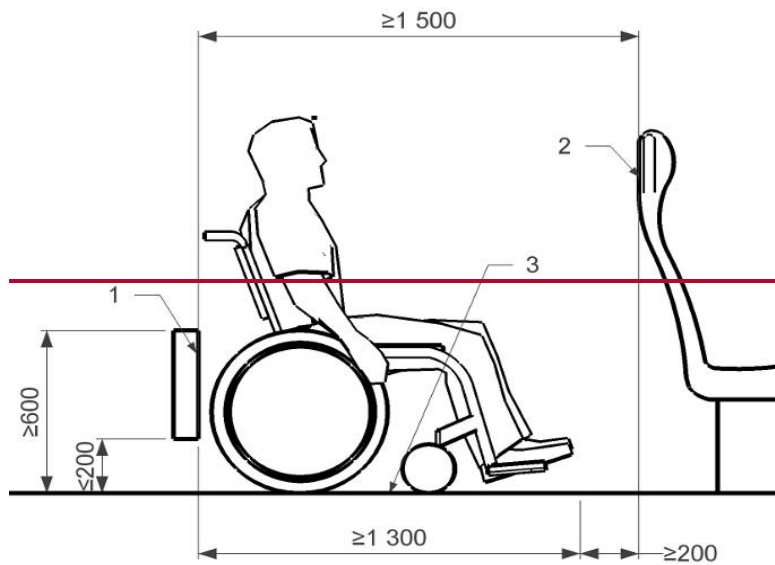



FIGURE 13 – TWO FACING WHEELCHAIR SPACES

1 – STRUCTURE AT END OF WHEELCHAIR SPACE

2 – SPACE BETWEEN WHEELCHAIR SPACES MIN. 250 MM

3 – WHEELCHAIR SPACE

| | | | |
|---|--|--------------------|------------------|
|  OTIF | Uniform Technical Prescription | | UTP PRM |
| | Accessibility for persons with disabilities and persons with reduced mobility | | Page 100 of 112 |
| Status: PROPOSAL | | TECH-25004 Annex 1 | Original: EN |
| | | | Date: 24.02.2025 |

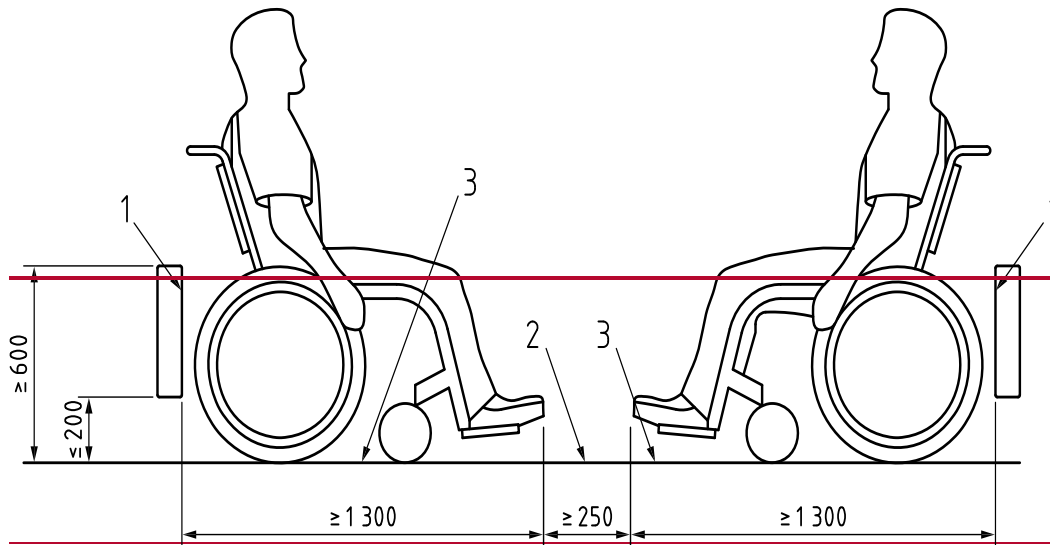

FIGURE I4 – TWO ADJACENT WHEELCHAIR SPACES (APPLICABLE TO UPGRADED/RENEWED ROLLING STOCK ONLY)

1 STRUCTURE AT END OF WHEELCHAIR SPACE

2 STRUCTURE IN FRONT OF WHEELCHAIR SPACE

3 DUAL WHEELCHAIR SPACE



OTIF

Uniform Technical Prescription

Accessibility for persons with disabilities and persons with reduced mobility

UTP PRM

Page 101 of 112

Status: **PROPOSAL**

TECH-25004 Annex 1

Original: EN

Date: 24.02.2025

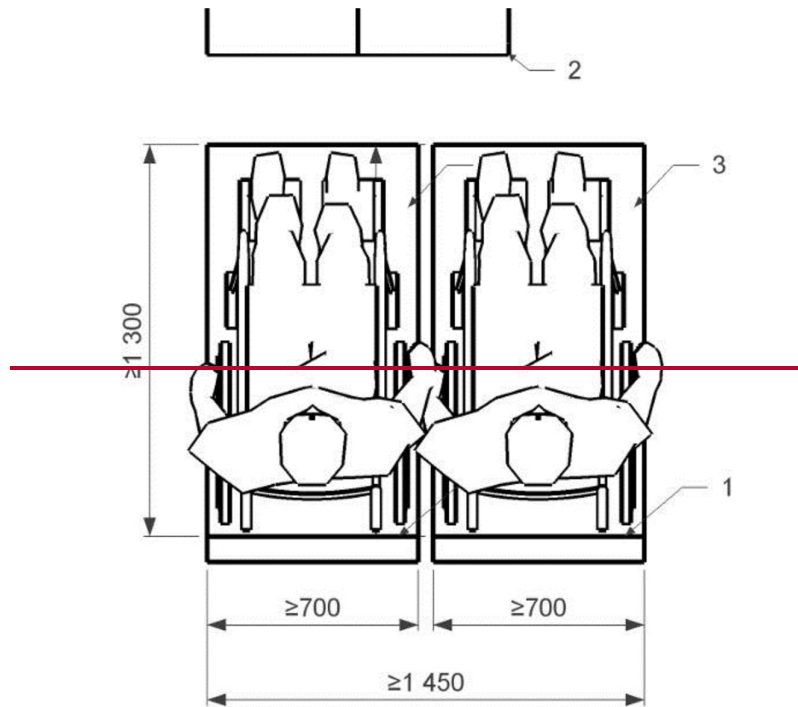

| | | | |
|---|--|--------------------|------------------|
|  OTIF | Uniform Technical Prescription | | UTP PRM |
| | Accessibility for persons with disabilities and persons with reduced mobility | | Page 102 of 112 |
| Status: PROPOSAL | | TECH-25004 Annex 1 | Original: EN |
| | | | Date: 24.02.2025 |

Appendix J:

not used ~~Diagrams of clearways~~

~~Figure J1—Minimum clearway width from floor level to a height of 1000 mm~~

~~1—Through section of clearway~~

~~2—Plan view at height range 25—975 mm from floor level~~

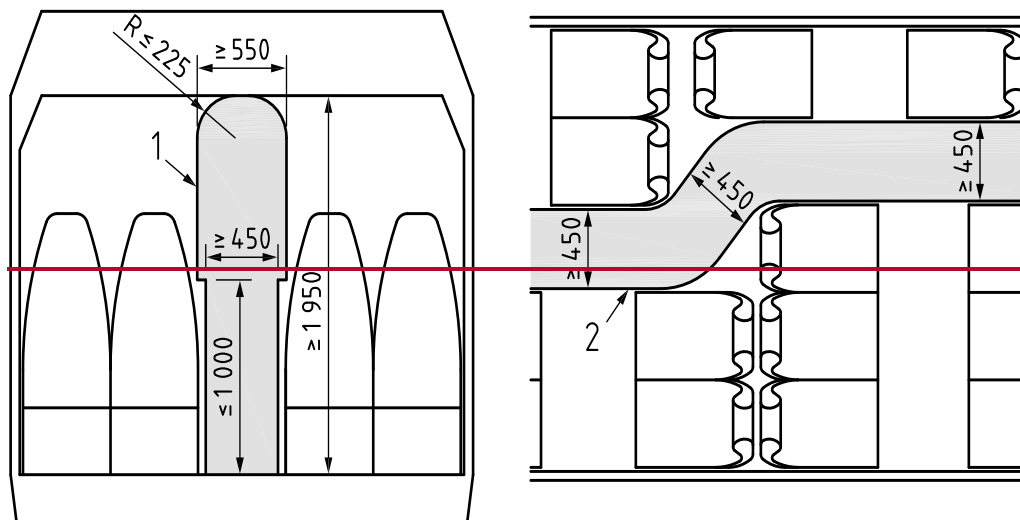

~~Figure J2—Minimum clearway profile between connecting vehicles of a single trainset~~

| | | | |
|---|--|--------------------|------------------|
|  OTIF | Uniform Technical Prescription | | UTP PRM |
| | Accessibility for persons with disabilities and persons with reduced mobility | | Page 103 of 112 |
| Status: PROPOSAL | | TECH-25004 Annex 1 | Original: EN |
| | | | Date: 24.02.2025 |

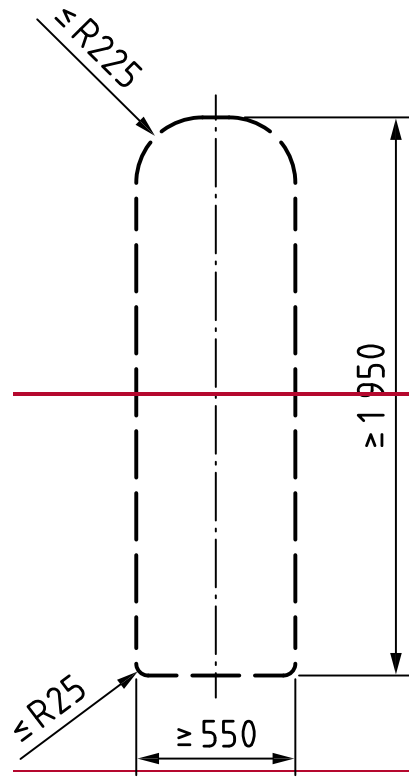

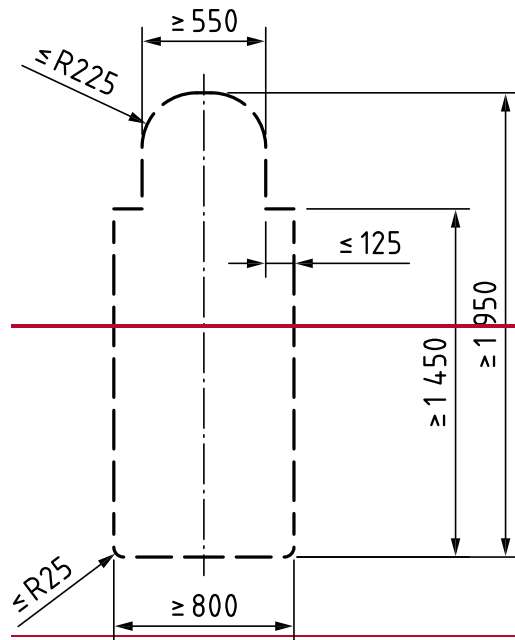



Figure J3— Minimum clearway profile to and from wheelchair spaces

| | | | |
|---|--|--------------------|----------------------------------|
|  OTIF | Uniform Technical Prescription Accessibility for persons with disabilities and persons with reduced mobility | | UTP PRM Page 104 of 112 |
| Status: PROPOSAL | | TECH-25004 Annex 1 | Original: EN Date: 24.02.2025 |



| | | | | |
|---|--|--------------------|--------------|------------------|
|  OTIF | Uniform Technical Prescription | | | UTP PRM |
| | Accessibility for persons with disabilities and persons with reduced mobility | | | Page 105 of 112 |
| Status: PROPOSAL | | TECH-25004 Annex 1 | Original: EN | Date: 24.02.2025 |

Appendix K:

not used: ~~Table of the corridor width for wheelchair accessible areas in Rolling Stock~~

~~Table K1~~

| | | | | | | |
|---|---------------|---------------|---------------|---------------|----------------|----------------|
| Corridor clearway width (mm) | 00 | 00 | 00 | 00 | 50 | 00 |
| AVAILABLE WIDTH, OR A PERPENDICULAR CORRIDOR CLEARWAY WIDTH (MM) | 00 | 50 | 00 | 00 | 100 | 200 |

| | | | |
|---|--|--------------------|----------------------------------|
|  OTIF | Uniform Technical Prescription Accessibility for persons with disabilities and persons with reduced mobility | | UTP PRM Page 106 of 112 |
| Status: PROPOSAL | | TECH-25004 Annex 1 | Original: EN Date: 24.02.2025 |

Appendix L:

~~not used~~ Reach zone of a wheelchair user

FIGURE L1 – REACH RANGE OF A PERSON IN A WHEELCHAIR

1 – COMFORTABLE REACH RANGE

2 – SEAT REFERENCE POINT

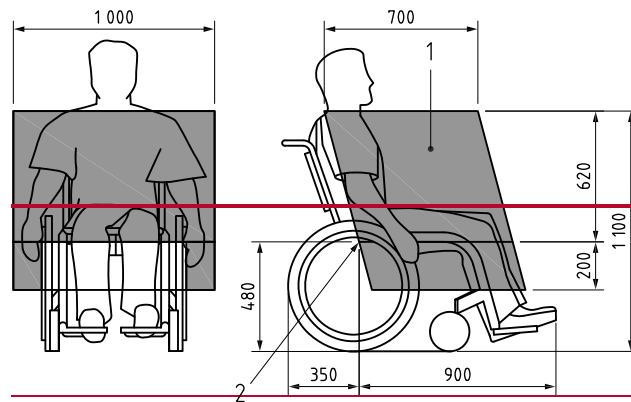

| | | | |
|---|--|--------------------|------------------|
|  OTIF | Uniform Technical Prescription | | UTP PRM |
| | Accessibility for persons with disabilities and persons with reduced mobility | | Page 107 of 112 |
| Status: PROPOSAL | | TECH-25004 Annex 1 | Original: EN |
| | | | Date: 24.02.2025 |

Appendix M: Interoperable Wheelchair transportable by train

M.1 SCOPE

This appendix identifies the maximum engineering limits for an interoperable wheelchair transportable by train. These limits are used for designing and assessing the rolling stock (architecture, structure, layout) and its components (access doors, internal doors, seats, toilets etc.). When the characteristics of a wheelchair exceed these limits, the conditions of use of the rolling stock might be degraded for the user (for instance no access to the wheelchair areas). Exceeding some limits may prevent the user from accessing the rolling stock.

These limits are defined by each railway undertaking as specified in the point 4.2.6.1 of the Annex to Regulation (EU) No 454/2011.

M.2 CHARACTERISTICS

The values considered as engineering limits are~~The minimum technical requirements are:~~

Basic Dimensions

- Width of 700 mm plus 50 mm min each side for hands when moving.
- Length of 1200 mm plus 50 mm for feet.

Wheels

The smallest wheel shall accommodate a gap of dimensions 75 mm horizontal and 50 mm vertical.

Height

1450~~1375~~ mm max including a 95th percentile male occupant.

Turning circle

1500 mm

Weight

- Fully laden weight of 300 kg for wheelchair and occupant (including any baggage) in the case of an electrical wheelchair for which no assistance is required for crossing a boarding aid.
- Fully laden weight of 200 kg for wheelchair and occupant (including any baggage) in the case of a manual wheelchair.

Obstacle height that can be overcome and ground clearance

- Obstacle height that can be overcome 50 mm (max).
- Ground clearance 60 mm (min) with a upward slope angle of 10° (17%) on top for going forward (under the foot rest).

Maximum safe slope on which the wheelchair will remain stable:

- Shall have dynamic stability in all directions at an angle of 6° (10%)~~degrees~~.
- Shall have static stability in all directions (including with brake applied) at an angle of 9° (16%)~~degrees~~.

| | | | |
|---|--|--------------------|------------------|
|  OTIF | Uniform Technical Prescription | | UTP PRM |
| | Accessibility for persons with disabilities and persons with reduced mobility | | Page 108 of 112 |
| Status: PROPOSAL | | TECH-25004 Annex 1 | Original: EN |
| | | | Date: 24.02.2025 |

Appendix N: PRM Signage

N.1 SCOPE

This appendix identifies specific signage for use on both infrastructure and rolling stock.

N.2 DIMENSIONS OF SIGNS

Infrastructure PRM signage dimensions shall be calculated according to the formula:

Reading distance in mm divided by 250, multiplied by 1.25 = frame size in mm, where a frame is utilised.

The minimum tile size of rolling stock interior PRM signs shall be 60 mm with the exception of signs indicating utilities in the toilets or in the nursery that can be smaller.

The minimum tile size of rolling stock exterior PRM signs shall be 85 mm.

N.3 SYMBOLS TO USE ON SIGNS

~~The signs provided for in point 4.2.1.10 shall have a dark blue background and a white symbol. Dark blue shall have a contrast of 0.6 relatively to white.~~

~~Where those signs are placed on a dark blue panel, it is allowed to invert the colours of the symbol and the background (i.e. dark blue symbol on a white background).~~

International wheelchair sign

The sign which identifies wheelchair accessible areas shall include a symbol in accordance with [one of](#) the specifications referenced in Appendix A, index [\[12\]](#) or [Index \[13\]](#).

Inductive loop sign

The sign indicating where inductive loops are fitted shall include a symbol in accordance with the specification referenced in Appendix A, index [\[14\]](#).

Priority seating sign

The sign indicating where there are priority seats shall include symbols in accordance with figure N1.



| | | | |
|---|--|--------------------|----------------------------------|
|  OTIF | Uniform Technical Prescription Accessibility for persons with disabilities and persons with reduced mobility | | UTP PRM Page 109 of 112 |
| Status: PROPOSAL | | TECH-25004 Annex 1 | Original: EN Date: 24.02.2025 |

Figure N1 – Symbols for priority seats



N.4 COLOUR OF SIGNS

The specific signage referred to in this Appendix shall be white on a dark blue background. Where signs are placed on a dark blue panel, it is allowed to invert the colours of the symbol and the background (i.e. dark blue symbol on a white background).

| | | | |
|---|--|--------------------|----------------------------------|
|  OTIF | Uniform Technical Prescription Accessibility for persons with disabilities and persons with reduced mobility | | UTP PRM Page 110 of 112 |
| Status: PROPOSAL | | TECH-25004 Annex 1 | Original: EN Date: 24.02.2025 |

Appendix O: List of technical documents

~~reserved~~ [Not used](#)

| | | | |
|---|--|--------------------|------------------|
|  OTIF | Uniform Technical Prescription | | UTP PRM |
| | Accessibility for persons with disabilities and persons with reduced mobility | | Page 111 of 112 |
| Status: PROPOSAL | | TECH-25004 Annex 1 | Original: EN |
| | | | Date: 24.02.2025 |

Appendix P: Changes of requirements and transition regimes

With the exception of the points listed in Table P.1 and Table P.2, compliance with the UTP PRM 2022 is deemed as compliance with this UTP.

For other TSI points than these listed in Table P.1 and Table P.2, compliance with the ‘previous TSI’ (i.e. this Regulation, as amended by Implementing Regulation (EU) 2019/772²⁸) imply compliance with this TSI applicable from 28 September 2023.

Changes with a generic transition regime of 7 years:

With regard to the points listed in Table P.1, compliance with the UTP PRM 2022 (or any previous version) does not constitute compliance with this UTP.

For TSI points listed in Table P.1, compliance with the previous TSI does not imply compliance with the version of this TSI applicable from 28 September 2023.

Projects that were already in their design phase on 28 September 2023 shall comply with the requirements of this UTP from 28 September 2030.

Projects already in design phase on 28 September 2023 shall comply with the requirement of this TSI from 28 September 2030.

Projects in production phase and units in operation are not affected by the UTP requirements listed in Table P.1.

Projects in production phase and rolling stock in operation are not affected by the TSI requirements listed in Table P.1

Table P.1 – transition regime of 7 years

| <u>UTP point(s)</u> | <u>UTP point(s) in previous UTP</u> | <u>Explanation of the UTP change</u> |
|--|-------------------------------------|--|
| <u>4.2.2.1.1 (1a)</u> | <u>No requirement</u> | <u>New requirement specifying the correct position of the handle</u> |
| <u>4.2.2.2 (8)</u> | <u>4.2.2.2 (8)</u> | <u>More precise wording of the requirement</u> |
| <u>4.2.2.3.2 (8)</u> <u>When a door is closed locally (by a passenger or crew), a door closing signal shall be given; it shall start following the operation of the control device and shall continue until the door is closed.</u> | <u>No requirement</u> | <u>New requirement</u> |
| <u>4.2.2.3.2 (11)</u> | <u>No requirement</u> | <u>New requirement</u> |
| <u>4.2.2.11.1 (3)</u> <u>The technical documentation referred to in point 4.2.12 of the LOC&PAS UTP shall</u> | <u>No requirement</u> | <u>New requirement</u> |

²⁸ Commission Implementing Regulation (EU) 2019/772 of 16 May 2019 amending Regulation (EU) No 1300/2014 as regards inventory of assets with a view to identifying barriers to accessibility, providing information to users and monitoring and evaluating progress on accessibility.

| | | | | |
|---|--|--------------------|-----------------|------------------|
|  OTIF | Uniform Technical Prescription | | UTP PRM | |
| | Accessibility for persons with disabilities and persons with reduced mobility | | Page 112 of 112 | |
| Status: PROPOSAL | | TECH-25004 Annex 1 | Original: EN | Date: 24.02.2025 |

| | | |
|---|---|--|
| include information about the height and offset of the theoretical platform resulting in a vertical gap (δ_v) of 160 mm and in a horizontal gap (δ_h) of 200 mm from the point situated in the central position of the nose of the rolling stock's lowest step on a straight level track. | | |
| 5.3.2.6 (1) | 5.3.2.6 (1) | Restriction of the possibilities given |
| 5.3.2.8 | 5.3.2.8 | New requirement in the specification referenced in Appendix A index [11] |
| 6.2.3.3 | No requirement | New requirement referring to a specific standard on contrast |
| Appendix G – door opening and closing signals | Appendix G – door opening and closing signals | Change of measuring method |

Changes with a specific transition regime:

[With regard to the points listed in Table P.2, compliance with the UTP PRM 2022 does not constitute compliance with this UTP.](#)

[Projects already in design phase on 28 September 2023, projects in production phase, and units in operation shall comply with the requirement of this UTP in accordance with the respective transition regime set out in Table P.2 starting from 1 January 2026.](#)

[For TSI points listed in table P.2, compliance with the previous TSI does not imply compliance with this TSI applicable from 28 September 2023.](#)

[Projects already in design phase on 28 September 2023, projects in production phase, and rolling stock in operation shall comply with the requirement of this TSI in accordance with the respective transition regime set out in Table P.2 starting from 28 September 2023.](#)

Table P.2 – specific transition regime

| UTP point(s) | UTP point(s) in previous UTP | Explanation on UTP change | Transition regime | | | |
|--------------------------------|--|---|--|--------------------------------------|----------------------------------|------------------------------------|
| | | | Design phase not started | Design phase started | Production phase | Units in operation |
| Not applicable | | | | | | |



Organisation intergouvernementale pour les transports internationaux ferroviaires

Zwischenstaatliche Organisation für den internationalen Eisenbahnverkehr

Intergovernmental Organisation for International Carriage by Rail

TECH-25004 Annex 2

Uniform Technical Prescription

Applicable to the
accessibility of the rail
system for persons with
disabilities and persons
with reduced mobility

UTP PRM

Applicable from [Click here to enter a date.](#)

| | | | |
|---|--|--------------------|------------------|
|  OTIF | Uniform Technical Prescription | | UTP PRM |
| | Accessibility for persons with disabilities and persons with reduced mobility | | Page 2 of 86 |
| Status: PROPOSAL | | TECH-25004 Annex 2 | Original: EN |
| | | | Date: 24.02.2025 |

APTU Uniform Rules (Appendix F to COTIF 1999)

Uniform Technical Prescription applicable to the accessibility of the rail system for persons with disabilities and persons with reduced mobility

(UTP PRM)

This UTP has been developed in accordance with COTIF 1999 as last modified on 1 November 2023 and in particular with Articles 3, 4, 6, 7, 7a and 8 of the APTU Uniform Rules (Appendix F to COTIF).

For definitions, see also Article 2 of the APTU Uniform Rules and Article 2 of the ATMF Uniform Rules (Appendix G to COTIF).

Footnotes are not legal provisions. They include both explanatory information and references to other regulations.

0. EQUIVALENCE AND APPLICATION

0.1 Equivalence

- (1) Following their adoption by the Committee of Technical Experts, the OTIF provisions regarding the rolling stock subsystem in this UTP are equivalent to the corresponding European Union (EU) regulations within the meaning of Article 13 § 4 letter b) of the APTU UR and Article 3a of the ATMF UR, in particular with:

- Commission Regulation (EU) No 1300/2014 of 18 November 2014, as last amended by Commission Implementing Regulation (EU) 2023/1694 of 10 August 2023, hereinafter referred to as the PRM TSI.

The equivalence is limited to the scope as defined in Chapters 1 and 2 of this UTP.

- (2) The aim of this UTP is to prescribe exhaustively the requirements for the accessibility of vehicles used in

| | | | |
|---|--|--------------------|------------------|
|  OTIF | Uniform Technical Prescription | | UTP PRM |
| | Accessibility for persons with disabilities and persons with reduced mobility | | Page 3 of 86 |
| Status: PROPOSAL | | TECH-25004 Annex 2 | Original: EN |
| | | | Date: 24.02.2025 |

international traffic for persons with disabilities and persons with reduced mobility.

Without prejudice to specific cases, Contracting States must not impose contradicting requirements for the use of vehicles in international traffic on their network.

Rules in addition to the UTP requirements may be imposed only in the form of national technical requirements in accordance with Article 12 of the APTU UR.

Contracting States may have additional or different accessibility requirements for vehicles used in domestic traffic only.

- (3) There are no mandatory provisions in this UTP for infrastructure, operational aspects, or telematics. Contracting States should however consider the interfaces between these subsystems and vehicles that comply with this UTP to facilitate PRM accessibility.
- (4) The objectives and scope of COTIF and the EU law concerning railways are not identical and it has therefore been necessary to use different terminology for concepts that have a similar but not identical meaning. The following table lists the terms used in this UTP and the corresponding terms used in the PRM TSI:

| This UTP | EU law |
|--|---|
| Uniform Technical Prescription (UTP) | Technical Specification of Interoperability (TSI) |
| The UTP verification procedure | The EC verification procedure |
| Assessing entity | Notified body |
| Assessment procedures for the verification of subsystems (modules) | EC verification of a subsystem (modules) |
| Contracting State | Member State |
| Type or design examination certificate | EC type or design examination certificate |

- (5) Where provisions in this UTP and the PRM TSI differ in substance, the respective texts are in a 2-

| | | | |
|---|--|--------------------|------------------|
|  OTIF | Uniform Technical Prescription | | UTP PRM |
| | Accessibility for persons with disabilities and persons with reduced mobility | | Page 4 of 86 |
| Status: PROPOSAL | | TECH-25004 Annex 2 | Original: EN |
| | | | Date: 24.02.2025 |

column format. The left-hand column and the full width texts show the UTP provisions and the right-hand column shows the European Union TSI texts. The list of specific cases in section 7.2 for Contracting States that are not members of the European Union are in full-width.

Texts in the right-hand column are strictly for information only. For EU law, consult the Official Journal of the European Union.

Where differences between texts of this UTP and the European Union PRM TSI are either editorial, or not substantive, or concern the list of terms quoted above, the PRM TSI texts are not generally reproduced. The TSI texts may however be reproduced in some instances to improve clarity and readability.

1. INTRODUCTION

This UTP lays down harmonised accessibility requirements for passenger vehicles used in international traffic.

National technical requirements may be imposed only in accordance with Article 12 of the APTU UR.

The objective of this technical specification for interoperability (TSI) is to enhance the accessibility of rail transport to persons with disabilities and persons with reduced mobility.

1.1 Technical scope

This UTP shall apply to the rolling stock subsystem as defined in point 2 of UTP GEN-B and in point 2.1.2 of this UTP.

The application of this UTP to the rolling stock subsystem is mandatory for passenger vehicles that are admitted to international traffic in accordance with the ATMF UR, taking into account the implementing rules in Chapter 7 of this UTP.

This UTP also concerns the infrastructure subsystem as defined in point 2.1.1 of this UTP.

The application of this UTP to the infrastructure subsystem is optional.

The technical scope of this TSI is defined in Article 2(1) of the Regulation.

1.2 Geographical scope

The geographical scope of this

| | | | |
|---|--|--------------------|------------------|
|  OTIF | Uniform Technical Prescription | | UTP PRM |
| | Accessibility for persons with disabilities and persons with reduced mobility | | Page 5 of 86 |
| Status: PROPOSAL | | TECH-25004 Annex 2 | Original: EN |
| | | | Date: 24.02.2025 |

UTP is defined by the lines open to, or used for international traffic in accordance with the ATMF UR.

This UTP concerns passenger vehicles used in international traffic on these lines and stations along these lines that are used for boarding and alighting from these vehicles.

TSI is defined in Article 2(2) of the Regulation.

2. SCOPE OF SUBSYSTEMS AND DEFINITIONS

2.1 Scope of the subsystems

This UTP contains requirements for several of the subsystems described in UTP GEN-B, in particular infrastructure, rolling stock, operation, and telematics. The following points define the scope of this UTP in relation to these subsystems.

2.1.1 Scope related to Infrastructure subsystem

In accordance with UTP GEN-A point 2.1 and UTP GEN-B point 2.1, COTIF includes infrastructure only to the extent that it is related to interfaces with the vehicles.

The interfaces between the rolling stock subsystem and the infrastructure subsystem covered by this UTP PRM are limited to the gap between the platform and the vehicle entrance (Section 4.3.1 of this UTP PRM). The platform-related requirements concerning the gap are laid down in the UTP INF. The vehicle-related requirements concerning the gap are laid down in this UTP PRM.

Consequently, there are no mandatory requirements applicable to the Infrastructure subsystem in this UTP PRM.

The provisions in this UTP PRM concerning public areas within stations are optional. These provisions are included for reference and to enable their voluntary application. Their application may contribute to consistent approaches to accessibility in stations and is therefore recommended.

This TSI applies to all the public areas of stations dedicated to the transport of passengers that are controlled by the railway undertaking, infrastructure manager or station manager. This includes the provision of information, the purchase of a ticket and its validation if needed, and the possibility to wait for the train.

2.1.2 Scope related to rolling stock subsystem

This UTP applies to rolling stock which is in the scope of the UTP LOC&PAS and which is intended to carry passengers.

| | | | |
|---|--|--------------------|------------------|
|  OTIF | Uniform Technical Prescription | | UTP PRM |
| | Accessibility for persons with disabilities and persons with reduced mobility | | Page 6 of 86 |
| Status: PROPOSAL | | TECH-25004 Annex 2 | Original: EN |
| | | | Date: 24.02.2025 |

This UTP does not apply to rolling stock intended for other purposes than the carriage of persons. Persons accompanying a freight train or riding on other rail vehicles than those intended for passengers shall be subject to conditions set up by the railway undertaking

or by the competent authority.

and published on its website.

2.1.3 Scope related to operational aspects subsystem

The operational procedures for the assistance of passengers with disabilities or with reduced mobility at stations and in trains are not in the scope of this UTP. However, these procedures should be compatible with rolling stock that complies with the UTPs.

This TSI applies to the procedures enabling a coherent operation of the infrastructure and rolling stock subsystems when passengers are persons with disabilities and persons with reduced mobility.

2.1.4 Scope related to Telematics Applications for Passengers subsystem

This UTP applies to visual and audible passenger information systems located in

stations and in

rolling stock.

Its application to visual and audible information in stations is voluntary.

2.2 Definition of “person with disabilities and person with reduced mobility”

“Person with disabilities and person with reduced mobility” means any person who has a permanent or temporary physical, mental, intellectual or sensory impairment which, in interaction with various barriers, may hinder their full and effective use of transport on an equal basis with other passengers or whose mobility when using transport is reduced due to age.

The transport of oversized items (for example: bicycles and bulky luggage) is not within the scope of this UTP.

2.3 Other definitions

Definitions related to rolling stock: refer to the UTP LOC&PAS point 2.2.

Accessibility data

Accessibility data consists of the information related to the accessibility of passenger railway stations that needs to be collected, maintained and exchanged, that is to say, of a description of the characteristics and equipment of the passenger railway stations. Where relevant that description is complemented by the information regarding the stations' state of conformity to this UTP.

Obstacle-free route

An obstacle-free route is a link between two or more public areas dedicated to the transport of passengers such as specified in point 2.1.1. It can be navigated by all persons with disabilities and reduced mobility. In order to achieve this, the route can be divided to better meet the needs of all persons

| | | | |
|---|--|--------------------|------------------|
|  OTIF | Uniform Technical Prescription | | UTP PRM |
| | Accessibility for persons with disabilities and persons with reduced mobility | | Page 7 of 86 |
| Status: PROPOSAL | | TECH-25004 Annex 2 | Original: EN |
| | | | Date: 24.02.2025 |

with disabilities and reduced mobility. The combination of all the parts of the obstacle free route constitutes the route accessible for all persons with disabilities and reduced mobility.

Step-free route

A step-free route is a division of an obstacle-free route that meets the needs of mobility impaired persons. Changes in level are avoided or, when they cannot be avoided, they are bridged via ramps or lifts.

“Tactile Signs” and “Tactile Controls”

“Tactile signs” and “tactile controls” are signs or controls, which include raised pictograms, raised characters or Braille lettering.

Station Manager

The station manager is an organisational entity in a Contracting State, which has been made responsible for the management of a railway station and which may be the infrastructure manager.

Safety Information

Safety information is information that shall be given to passengers so that they know in advance how they have to behave in case of an emergency.

Safety Instructions

Safety instructions are the instructions that shall be given to passengers in case of an emergency so that they understand what to do.

Level access

A level access is an access from a platform to the doorway of a rolling stock for which it can be demonstrated that:

- The gap between the door sill of that doorway (or of the extended bridging plate of that doorway) and the platform does not exceed 75 mm measured horizontally and 50 mm measured vertically, and
- The rolling stock has no internal step between the doorsill and the vestibule.

“Interoperable wheelchair transportable by train”

An interoperable wheelchair transportable by train is a wheelchair the characteristics of which permit the full usage of all features of rolling stock designed for wheelchair users. The characteristics of an interoperable wheelchair transportable by train are within the limits specified in Appendix M.

3. ESSENTIAL REQUIREMENTS

The following tables indicate the essential requirements, as set out in

| | | | |
|---|--|--------------------|------------------|
|  OTIF | Uniform Technical Prescription | | UTP PRM |
| | Accessibility for persons with disabilities and persons with reduced mobility | | Page 8 of 86 |
| Status: PROPOSAL | | TECH-25004 Annex 2 | Original: EN |
| | | | Date: 24.02.2025 |

UTP GEN-A

Annex III of Directive (EU) 2016/797 of the European Parliament and of the Council¹,

that are met by the specifications set out in Chapter 4 of this UTP for the scope of this UTP. The essential requirements that are not listed in the table are not relevant within the scope of this UTP.

Table 1: Essential requirements for the Infrastructure subsystem

| Infrastructure | | Reference to Essential Requirement in UTP GEN-A | | | | | |
|--|-----------------------------|---|------------------------------|--------|--------------------------|-------------------------|---------------|
| Element of the UTP Domain | Reference point of this UTP | Safety | Reliability and Availability | Health | Environmental protection | Technical compatibility | Accessibility |
| Parking facilities for persons with disabilities and persons with reduced mobility | 4.2.1.1 | | | | | | * |
| Obstacle-free route | 4.2.1.2 | * | | | | | * |
| Doors and entrances | 4.2.1.3 | 1.1.1 * | | | | | * |
| Floor surfaces | 4.2.1.4 | * | | | | | * |
| Highlighting of transparent obstacles | 4.2.1.5 | * | | | | | * |
| Toilets and baby-nappy changing facilities | 4.2.1.6 | 1.1.5 * | | | | | * |
| Furniture and free-standing devices | 4.2.1.7 | * | | | | | * |
| Ticketing, information desks and customer assistance points | 4.2.1.8 | * | 2.7.3 | | | 2.7.1 | * * |
| Lighting | 4.2.1.9 | * | | | | | * |
| Visual information: signposting, pictograms, printed or dynamic information | 4.2.1.10 | | | | | 2.7.1 | * * |
| Spoken information | 4.2.1.11 | * | 2.7.3 | | | 2.7.1 | * * |

¹ Directive (EU) 2016/797 of the European Parliament and of the Council of 11 May 2016 on the interoperability of the rail system within the European Union

| | | | |
|---|--|--------------------|------------------|
|  OTIF | Uniform Technical Prescription | | UTP PRM |
| | Accessibility for persons with disabilities and persons with reduced mobility | | Page 9 of 86 |
| Status: PROPOSAL | | TECH-25004 Annex 2 | Original: EN |
| | | | Date: 24.02.2025 |

| Infrastructure | | Reference to Essential Requirement in UTP GEN-A | | | | | |
|-------------------------------------|-----------------------------|---|------------------------------|--------|---------------------------|-------------------------|---------------|
| Element of the UTP Domain | Reference point of this UTP | Safety | Reliability and Availability | Health | Environ-mental protection | Technical compatibility | Accessibility |
| Platform width and edge of platform | 4.2.1.12 | * | | | | | * |
| End of platform | 4.2.1.13 | * | | | | | * |
| Boarding aids on platforms | 4.2.1.14 | 1.1.1 | | | | | * |
| Level track crossing at stations | 4.2.1.15 | * | | | | | * |

Cells in table 1 marked with an asterisk (*) have a corresponding Essential Requirement in EU law which does not exist in COTIF UTP GEN-A.

Table 2: Essential requirements for the rolling stock subsystem

| Rolling stock | | Reference to Essential Requirement in UTP GEN-A | | | | | |
|---------------------------|-----------------------------|---|------------------------------|--------------|---------------------------|-------------------------|--------------------|
| Element of the UTP Domain | Reference point of this UTP | Safety | Reliability and Availability | Health | Environ-mental protection | Technical compatibility | Accessibility |
| Seats | 4.2.2.1 | | | 1.3.1 | | | 2.4.5 |
| Wheelchair spaces | 4.2.2.2 | 2.4.1 | | | | | 2.4.5 |
| Doors | 4.2.2.3 | 1.1.1 1.1.5 2.4.1 | 1.2 | | | | 2.4.5 |
| Lighting | 4.2.2.4 | 2.4.1 | | | | | 2.4.5 |
| Toilets | 4.2.2.5 | 2.4.1 | | | | | 2.4.5 |
| Clearways | 4.2.2.6 | | | 1.3.1 | | | 2.4.5 |
| Customer information | 4.2.2.7 | 2.4.1 | 2.7.3 | | | 2.7.1 | 2.4.5 * |
| Height changes | 4.2.2.8 | 1.1.5 | | | | | 2.4.5 |

| | | | | |
|---|--|--------------------|---------------|------------------|
|  OTIF | Uniform Technical Prescription | | UTP PRM | |
| | Accessibility for persons with disabilities and persons with reduced mobility | | Page 10 of 86 | |
| Status: PROPOSAL | | TECH-25004 Annex 2 | Original: EN | Date: 24.02.2025 |

| Rolling stock | | Reference to Essential Requirement in UTP GEN-A | | | | | |
|--|-----------------------------|---|------------------------------|--------|---------------------------|-------------------------|---------------|
| Element of the UTP Domain | Reference point of this UTP | Safety | Reliability and Availability | Health | Environ-mental protection | Technical compatibility | Accessibility |
| Handrails | 4.2.2.9 | 1.1.5 | | | | | 2.4.5 |
| Wheelchair accessible sleeping accommodation | 4.2.2.10 | 2.4.1 | | | | | 2.4.5 |
| Step position for vehicle access and egress | 4.2.2.11 | 1.1.1 | 2.4.2 | | | 1.5 2.4.3 | 2.4.5 |
| Boarding aids | 4.2.2.12 | 1.1.1 | | | | 1.5 2.4.3 | 2.4.5 |

The cell in table 2 marked with an asterisk (*) has a corresponding Essential Requirement in EU law. In UTP GEN-A, points 1.6.1 and 1.6.2, accessibility is covered as far as rolling stock is concerned. Accessibility with regard to operations and telematics is not an Essential Requirement in COTIF.

4. CHARACTERISATION OF THE SUBSYSTEMS

4.1 Introduction

- (1) In accordance with Article 8 of the APTU UR, UTPs apply to subsystems. Subsystems are defined in UTP GEN-B. The consistency between the different subsystems shall be verified. This consistency shall be checked in particular with regard to the specifications of each subsystem, its interfaces vis-à-vis the system in which it is integrated as well as the operating and maintenance rules.
- (2) The functional and technical specifications of the subsystems and their interfaces, described in points 4.2 and 4.3, do not impose the use of specific technologies or technical solutions, except where this is strictly necessary for the interoperability of vehicles in international traffic.

The rail system of the Union, to which Directive (EU) 2016/797 applies and of which the subsystems are parts, is an integrated system whose consistency

the Union rail network.

| | | | |
|---|--|--------------------|------------------|
|  OTIF | Uniform Technical Prescription | | UTP PRM |
| | Accessibility for persons with disabilities and persons with reduced mobility | | Page 11 of 86 |
| Status: PROPOSAL | | TECH-25004 Annex 2 | Original: EN |
| | | | Date: 24.02.2025 |

But innovative solutions for interoperability may require new specifications and/or new assessment methods. In order to allow technological innovation, these specifications and assessment methods shall be developed

in a coordinated way, with the involvement of the Committee of Technical Experts.

Innovative solutions may be related to the rolling stock subsystem, its parts and its ICs.

The process to be followed for the application of innovative solutions for the rolling stock subsystem is defined in the UTP LOC&PAS.

by the process described in Article 6 of the Regulation.

⁽²⁾

1. *Technological progress may require innovative solutions, which do not comply with the specifications set out in the Annex or for which the assessment methods set out in the Annex cannot be applied.*
2. *Innovative solutions may concern the infrastructure and rolling stock subsystems, their parts and their interoperability constituents.*
3. *If an innovative solution is proposed, the manufacturer or his authorised representative established within the Union shall state how it deviates from the relevant provision of the TSI set out in the Annex and submit it to the Commission for analysis. The Commission may request the Agency's opinion on the proposed innovative solution and, where appropriate, may consult relevant stakeholders.*
4. *The Commission shall deliver an opinion on the proposed innovative solution. If this opinion is positive, the appropriate functional and interface specifications and the assessment method needed in the TSI to enable use to be made of this innovative solution shall be developed and subsequently incorporated in the TSI during the revision process. If the opinion is negative, the innovative solution proposed cannot be applied.*
5. *Pending the revision of the TSI, the positive opinion delivered by the Commission shall be considered as acceptable means of compliance with the essential requirements of Directive 2008/57/EC and may be used for the assessment of subsystems and projects.*

² These provisions are set out in Article 6 of the PRM TSI

| | | | |
|---|--|--------------------|------------------|
|  OTIF | Uniform Technical Prescription | | UTP PRM |
| | Accessibility for persons with disabilities and persons with reduced mobility | | Page 12 of 86 |
| Status: PROPOSAL | | TECH-25004 Annex 2 | Original: EN |
| | | | Date: 24.02.2025 |

- (3) Taking account of all the applicable essential requirements, the basic parameters related to accessibility for persons with disabilities and persons with reduced mobility are set out for the subsystems infrastructure and rolling stock in point 4.2 of this UTP. The operational requirements and responsibilities

for the assistance of passengers are deemed to be regulated at national level. | are set out in the Commission Implementing Regulation (EU) 2019/773³ (OPE TSI) and in point 4.4 of this TSI.

4.2 Functional and technical specifications

4.2.1 Infrastructure Subsystem

- (1) Application of all the provisions in point 4.2.1 and its sub-points is optional, despite the requirements being formulated as imperatives. |

In light of the essential requirements in Section 3, the functional and technical specifications of the infrastructure subsystem related to accessibility for persons with disabilities and persons with reduced mobility are arranged as follows:

- Parking facilities for persons with disabilities and persons with reduced mobility,
- Obstacle-free routes,
- Doors and entrances,
- Floor surfaces,
- Highlighting of transparent obstacles,
- Toilets and baby nappy changing facilities,
- Furniture and free-standing devices,
- Ticketing, information desks and customer assistance points,
- Lighting,
- Visual information: signposting, pictograms, printed or dynamic information,
- Spoken information,
- Platform width and edges of platforms,
- End of platforms,
- Boarding aids stored on platforms,
- Level track crossings.

³ OPE TSI means Commission Implementing Regulation (EU) 2019/773 of 16 May 2019 on the technical specification for interoperability relating to the operation and traffic management subsystem of the rail system within the European Union and repealing Decision 2012/757/EU.

| | | | |
|---|--|--------------------|------------------|
|  OTIF | Uniform Technical Prescription | | UTP PRM |
| | Accessibility for persons with disabilities and persons with reduced mobility | | Page 13 of 86 |
| Status: PROPOSAL | | TECH-25004 Annex 2 | Original: EN |
| | | | Date: 24.02.2025 |

- (2) The basic parameters that are specified in points 4.2.1.1 – 4.2.1.15 apply to the scope of the infrastructure subsystem that is defined in point 2.1.1; they can be divided into two categories:
- Those for which technical details need to be specified, such as the parameters relative to the platforms and how to reach the platforms. In this first case, the basic parameters are specifically described and the technical details to be satisfied in order to fulfil the requirement are detailed.
 - Those for which technical details are not necessary to be specified, such as the value of ramps or the characteristics of parking places. In this second case, the basic parameter is defined as a functional requirement that can be met by applying several technical solutions.

The table 3 below indicates the category of each of the basic parameters.

Table 3: Categories of basic parameters

| Basic Parameter | Technical details provided | Functional requirement only |
|--|--|------------------------------------|
| Parking facilities for persons with disabilities and persons with reduced mobility | | Complete point 4.2.1.1 |
| Obstacle-free route | Location of the routes Width of the obstacle-free route Threshold Double handrails Type of lift Height of braille signs | Detailed characteristics |
| Doors and entrances | 4.2.1.3 (2): Door width 4.2.1.3 (4): Height of door operating device | 4.2.1.3 (1) 4.2.1.3 (3) |
| Floor surfaces | 4.2.1.4 (2): Floor irregularities | 4.2.1.4 (1): Slip resistance |
| Highlighting of transparent obstacles | | Complete point 4.2.1.5 |
| Toilets and baby nappy changing facilities | | Complete point 4.2.1.6 |
| Furniture and free-standing devices | | Complete point 4.2.1.7 |
| Ticketing, Information desks and Customer Assistance points | 4.2.1.8 (5): Passageway for ticket control machines | 4.2.1.8 (1) to (4) 4.2.1.8 (6) |

| | | | |
|---|--|--------------------|------------------|
|  OTIF | Uniform Technical Prescription | | UTP PRM |
| | Accessibility for persons with disabilities and persons with reduced mobility | | Page 14 of 86 |
| Status: PROPOSAL | | TECH-25004 Annex 2 | Original: EN |
| | | | Date: 24.02.2025 |

| | | |
|---|---|---|
| Lighting | 4.2.1.9 (3): Lighting on platforms | 4.2.1.9 (1), 4.2.1.9 (2), 4.2.1.9 (4): Lighting in other locations |
| Visual information: signposting, pictograms, printed or dynamic information | Detail of information to be provided Location of information | Detailed characteristics of visual information |
| Spoken information | Complete point 4.2.1.11 | |
| Platform width and edge of platform | 4.2.1.12 (2) to (5) 4.2.1.12 (6) to (9): Presence of the items | 4.2.1.12 (1) 4.2.1.12 (6) to (9): Characteristics of contrast and of visual and tactile markings |
| End of platform | 4.2.1.13: Presence of the items | 4.2.1.13: Characteristics of contrast and of visual and tactile markings |
| Boarding aids stored on platforms | Complete point 4.2.1.14 | |
| Passenger track level crossing at stations | Complete point 4.2.1.15 | |

4.2.1.1 Parking facilities for persons with disabilities and persons with reduced mobility

- (1) Where a station specific parking area exists, there shall be sufficient and adapted parking spaces reserved for persons with disabilities and persons with reduced mobility eligible to utilise them at the nearest practicable position, within the parking area, to an accessible entrance.

4.2.1.2 Obstacle-free route

- (1) Obstacle free routes shall be provided that interconnect the following public areas of the infrastructure if provided:
- Stopping points for other connecting modes of transport within the station confines (for example, taxi, bus, tram, metro, ferry etc.),
 - Car parks,
 - Accessible entrances and exits,
 - Information desks,
 - Visual and audible information systems,
 - Ticketing facilities,
 - Customer assistance,
 - Waiting areas,

| | | | |
|---|--|--------------------|------------------|
|  OTIF | Uniform Technical Prescription | | UTP PRM |
| | Accessibility for persons with disabilities and persons with reduced mobility | | Page 15 of 86 |
| Status: PROPOSAL | | TECH-25004 Annex 2 | Original: EN |
| | | | Date: 24.02.2025 |

- Toilet facilities,
- Platforms,

- (2) All obstacle-free routes, footbridges and subways, shall have a free width of a minimum of 160 cm, except in areas that are specified in points 4.2.1.2.2 (3a) (ramps), 4.2.1.3 (2) (doors), 4.2.1.12 (3) (platforms) and 4.2.1.15 (2) (level crossings).
- (3) Obstacle-free route floor surfaces and ground surfaces shall have low reflecting properties.

4.2.1.2.1 *Horizontal circulation*

- (1) Where thresholds are installed on a horizontal route, they shall contrast with the surrounding floor and shall not be higher than 2.5 cm.

4.2.1.2.2 *Vertical circulation*

- (1) Where an obstacle-free route includes a change in level, there shall be a step-free route providing an alternative to stairs for mobility impaired people.
- (2) Steps and stairs on the obstacle-free routes shall have a minimum width of 160 cm measured between the handrails.
- (2a) As a minimum, the first and last steps of a flight of stairs shall be indicated by a contrasting band. This requirement shall apply from a single step.
- (2b) As a minimum, tactile warning surface indicators shall be installed before the first descending step of staircases of three steps or more.
- (3) Ramps shall be installed for persons with disabilities and persons with reduced mobility unable to use stairs where lifts are not provided. They shall have a moderate gradient. A steep gradient is allowed for ramps on short distances only.
 - (3a) When they are used as a complement to stairs, ramps may have a width of 120 cm measured at floor surface.
- (4) Stairs of three steps or more and ramps shall be provided with handrails on both sides and at two levels.
- (5) Lifts shall be provided where ramps are not available and shall be at least of type 2 in accordance with the specification referenced in Appendix A, Index [1]. Type 1 lifts are allowed in the case of stations being renewed or upgraded only.
- (6) Escalators and moving walks shall be designed in accordance with the specification referenced in Appendix A, Index [2].
- (7) Level track crossings can form part of an obstacle-free route when they comply with the requirements of point 4.2.1.15.

4.2.1.2.3 *Route identification*

- (1) Obstacle-free routes shall be clearly identified by visual information as detailed in point 4.2.1.10.

| | | | |
|---|--|--------------------|------------------|
|  OTIF | Uniform Technical Prescription | | UTP PRM |
| | Accessibility for persons with disabilities and persons with reduced mobility | | Page 16 of 86 |
| Status: PROPOSAL | | TECH-25004 Annex 2 | Original: EN |
| | | | Date: 24.02.2025 |

- (2) Information on the obstacle-free route shall be given to visually impaired people by a walking surface that has tactile and contrasting indicators as a minimum. This point does not apply to obstacle free routes to and from car parks.
- (2a) If more than one facility of a certain type of public area is provided, the route to at least one of them shall be indicated by tactile and contrasting walking surface indicators.
- (2b) Tactile walking surface indicators can be omitted when the route is indicated unambiguously by built or natural elements, such as edges and surfaces that can be followed tactually and visually.
- (3) Technical solutions using remotely controlled audible devices or telephone applications are permitted to be used in addition or as an alternative. When they are intended to be used as an alternative, they shall be treated as innovative solutions.
- (4) If there are handrails or walls within reach along the obstacle-free route to the platform, they shall have brief information (for example platform-number or direction-information). The information shall be in Braille or prismatic-letters or numbers. The information shall be located on the handrail, or on the wall at a height between 145 cm and 165 cm.

4.2.1.3 Doors and entrances

- (1) This point applies to all doors and entrances that are on obstacle-free routes, with the exception of doors giving access to the toilets which are not dedicated to persons with disabilities and persons with reduced mobility.
- (2) Doors shall have a minimum clear usable width of 90 cm and shall be operable by persons with disabilities and persons with reduced mobility.
- (3) It is permitted to use manual, semi-automatic or automatic doors.
- (4) Door operating devices shall be available at a height of between 80 cm and 110 cm.

4.2.1.4 Floor surfaces

- (1) All floor coverings, ground surfaces and stair tread surfaces shall be slip resistant.
- (2) Within the station buildings there shall be no irregularities in excess of 0.5 cm at any given point in floor walking surface areas, except for thresholds, drainage channels and tactile walking surface indicators.

4.2.1.5 Highlighting of Transparent obstacles

- (1) Transparent obstacles on or along the routes used by passengers, consisting of glass doors or transparent walls, shall be marked. These markings shall highlight the transparent obstacles. They are not required if passengers are protected from impact by other means – for example, by handrails or continuous benches.

4.2.1.6 Toilets and baby nappy changing facilities

- (1) If toilets are provided at a station, then a minimum of one unisex cubicle shall be wheelchair accessible.

| | | | |
|---|--|--------------------|------------------|
|  OTIF | Uniform Technical Prescription | | UTP PRM |
| | Accessibility for persons with disabilities and persons with reduced mobility | | Page 17 of 86 |
| Status: PROPOSAL | | TECH-25004 Annex 2 | Original: EN |
| | | | Date: 24.02.2025 |

- (2) If baby nappy changing facilities are provided at a station, then a minimum of one baby nappy changing facility shall be accessible to both men and women wheelchair users.

4.2.1.7 Furniture and free-standing devices

- (1) All items of furniture and free-standing devices at stations shall contrast with their background, and have rounded edges.
- (2) Within the station confines, furniture and free-standing devices (including cantilevered and suspended items) shall be positioned where they do not obstruct blind or visually impaired people, or they shall be detectable by a person using a long cane.
- (3) On each platform where passengers are allowed to wait for trains, and at every waiting area, there shall be a minimum of one area fitted with seating facilities and a space for a wheelchair.
- (4) When this area is weather protected, it shall be accessible by a wheelchair user.

4.2.1.8 Ticketing, Information desks and Customer Assistance points

- (1) Where manual ticket sales counters, information desks and customer assistance points are provided, a minimum of one desk shall be accessible to a wheelchair user and to people of small stature and a minimum of one desk shall be fitted with an induction loop system for hearing assistance.
- (2) If there is a glass barrier between the passenger and sales person at the ticket counter, this shall either be removable or, if not removable, an intercom system shall be fitted. Any such glass barrier shall consist of clear glass.
- (3) If electronic devices are fitted that displays pricing information to the sales person, such devices shall also be fitted that display the price to the person purchasing the ticket.
- (4) Where ticket vending machines are provided at a station, a minimum of one of these machines shall have an interface that is reachable by a wheelchair user and people of small stature. This requirement applies to each ticket vendor providing vending machines in the station.
- (5) If ticket control machines are fitted, a minimum of one of the machines shall have a free passageway with a minimum width of 90 cm and shall be able to accommodate an occupied wheelchair up to 1250 mm in length. In the case of upgrade or renewal, a minimum width of 80 cm is permitted.
- (6) If turnstiles are used, there shall be a non-turnstile access point available for use by persons with disabilities and persons with reduced mobility at all operational times.

4.2.1.9 Lighting

- (1) The illuminance level of the external areas of the station shall be sufficient to facilitate way finding and to highlight the changes of level, doors and entrances.
- (2) The illuminance level along obstacle-free routes shall be adapted to the visual task of the passenger. Particular attention shall be paid to the changes of levels, ticket vending offices and machines, information desks and information displays.

| | | | |
|---|--|--------------------|------------------|
|  OTIF | Uniform Technical Prescription | | UTP PRM |
| | Accessibility for persons with disabilities and persons with reduced mobility | | Page 18 of 86 |
| Status: PROPOSAL | | TECH-25004 Annex 2 | Original: EN |
| | | | Date: 24.02.2025 |

- (3) The platforms shall be illuminated in accordance with the specification referenced in Appendix A, Index [3] and Index [4].
- (4) Emergency lighting shall provide sufficient visibility for evacuation and for identification of fire-fighting and safety equipment.

4.2.1.10 Visual information: signposting, pictograms, printed or dynamic information

- (1) The following information shall be provided:
 - Safety Information and Safety Instructions,
 - Warning, prohibition and mandatory actions signs,
 - Information concerning the departure of trains,
 - Identification of station facilities, where provided, and access routes to those facilities.
- (2) The fonts, symbols and pictograms used for visual information shall contrast with their background.
- (3) Signposting shall be provided at all points where passengers need to make a route taking decision and at intervals on the route. Signage, symbols and pictograms shall be applied consistently over the whole route.
- (4) The information concerning the departure of trains (including destination, intermediate stops, platform number and time) shall be available and suitable for reading from a height of 160 cm at least in one location in the station.
- (5) The typeface used for texts shall be easily readable.
- (6) All safety, warning, mandatory action and prohibition signs shall include pictograms.
- (7) Tactile information signage shall be fitted in:
 - Toilets, for functional information and call for aid if appropriate,
 - Lifts in accordance with the specification referenced in Appendix A, index [1].
- (8) Time information presented in digits shall be in the 24h system.
- (9) The following specific graphic symbols and pictograms shall be fitted with the wheelchair symbol in accordance with Appendix N:
 - Directional information for wheelchair specific routes.
 - Indication of the wheelchair accessible toilets and other amenities if provided.
 - If there is train configuration information on the platform, indication of the wheelchair boarding location.

The symbols are permitted to be combined with other symbols (for example: lift, toilet, etc.).
- (10) Where inductive loops are fitted, these shall be indicated by a sign as described in Appendix N.

| | | | |
|---|--|--------------------|------------------|
|  OTIF | Uniform Technical Prescription | | UTP PRM |
| | Accessibility for persons with disabilities and persons with reduced mobility | | Page 19 of 86 |
| Status: PROPOSAL | | TECH-25004 Annex 2 | Original: EN |
| | | | Date: 24.02.2025 |

- (11) In wheelchair accessible toilets, where hinged handrails are provided, a graphic symbol showing the rail in both the stowed and deployed position shall be provided.
- (12) There shall be no more than five pictograms, in addition to a directional arrow, indicating a single direction placed adjacent to each other at a single location.
- (13) Displays shall be sized to show individual station names (which may be abbreviated) or words of messages. Each station name, or words of messages, shall be displayed for a minimum of 2 seconds. The term “display” shall be understood as any support of dynamic information.
- (14) If a scrolling display is used (either horizontal or vertical), each complete word shall be displayed for a minimum of 2 seconds and the horizontal scrolling speed shall not exceed 6 characters per second.
- (15) Displays shall be designed for a maximum viewing distance in accordance with the following formula:
Reading distance in mm divided by 250 = character height (for example: 10 000 mm/250 = 40 mm).

4.2.1.11 Spoken information

- (1) The spoken information shall have a minimum STI-PA level of 0.45, in accordance with the specification referenced in Appendix A, index [5].

4.2.1.12 Platform width and edge of platform

- (1) The danger area of a platform commences at the rail side edge of the platform and is defined as the area where passengers are not allowed to stand when trains are passing or arriving.
- (2) It is permitted for the width of the platform to be variable on the whole length of the platform.
- (3) The minimum width of the platform without obstacles shall be the width of the danger area plus the width of two opposing freeways of 80 cm (160 cm). This dimension may taper to 90 cm at the platform ends.
- (4) It is permitted to have obstacles inside this freeway of 160 cm. Equipment required for the signalling system and safety equipment shall not be considered as obstacles in this point. The minimum distance from obstacles to the danger area shall be according to the following table:

Table 4: Minimum distance from obstacles to the danger area

| Length of obstacles (measured parallel to the platform edge) | Minimum distance to the danger area |
|---|-------------------------------------|
| < 1 m (note 1) – small obstacle | 80 cm |
| 1 m to < 1 m – large obstacle | 120 cm |

Note 1: if the distance between two small obstacles is less than 2.4 m measured parallel to the platform edge they shall be considered as one large obstacle.

| | | | |
|---|--|--------------------|------------------|
|  OTIF | Uniform Technical Prescription | | UTP PRM |
| | Accessibility for persons with disabilities and persons with reduced mobility | | Page 20 of 86 |
| Status: PROPOSAL | | TECH-25004 Annex 2 | Original: EN |
| | | | Date: 24.02.2025 |

Note 2: Within this minimum distance from a large obstacle to the danger area it is permitted to have additional small obstacles as long as the requirements for small obstacles (minimum distance to danger area and minimum distance to next small obstacle) are met.

-
- (5) [Reserved]
 - (6) The boundary of the danger area, furthest from the rail side edge of the platform, shall have a visual marking and tactile walking surface indicators.
 - (7) The visual marking shall be a contrasting, slip resistant, warning line with a minimum width of 10 cm.
 - (8) Tactile walking surface indicators can be one of the two types:
 - an attention pattern indicating a hazard at the boundary of the danger area,
 - a guiding pattern indicating a path of travel at the safe side of the platform.
 - (9) The material at the rail side edge of the platform shall contrast with the darkness of the gap.

4.2.1.13 End of platform

- (1) The end of the platform shall either be fitted with a barrier that prevents public access or shall have a visual marking and tactile walking surface indicators with an attention pattern indicating a hazard.

4.2.1.14 Boarding aids stored on platforms

- (1) If a platform ramp is used, it shall comply with the requirements of point 5.3.1.2.
- (2) If a platform lift is used, it shall comply with the requirements of point 5.3.1.3.
- (3) A secure storage method shall be provided to ensure that boarding aids, including portable ramps, when stored on a platform, do not cause an obstruction or pose any hazard to passengers.

4.2.1.15 Passenger track crossing to platforms

- (1) Level track crossings are permitted to be used as part of a step-free route or of an obstacle-free route.
- (2) If level track crossings are used as parts of step free routes in addition to other routes, they shall:
 - have a minimum width of 120 cm (less than 10 m in length) or 160 cm (10 m or more in length),
 - have moderate slopes; a steep gradient is only allowed for ramps on short distances,
 - be designed so that the smallest wheel of a wheelchair, as defined in Appendix M, cannot be trapped within the crossing surface and the rail,
 - where accesses to level crossings are equipped with safety chicanes in order to prevent people from unintended/uncontrolled crossing of the tracks, the minimum width of the walkways in the straight line and in the chicane can be less than 120 cm with a minimum of 90 cm; it shall be sufficient for a wheelchair user to manoeuvre.

| | | | |
|---|--|--------------------|------------------|
|  OTIF | Uniform Technical Prescription | | UTP PRM |
| | Accessibility for persons with disabilities and persons with reduced mobility | | Page 21 of 86 |
| Status: PROPOSAL | | TECH-25004 Annex 2 | Original: EN |
| | | | Date: 24.02.2025 |

- (3) If level track crossings are used as parts of obstacles free routes, unique solution for all passengers, they shall:
- meet all specifications above,
 - have visual and tactile markings to identify the beginning and the end of the crossing surface,
 - be supervised, or, on the basis of national rules, equipment for a safe crossing of blind or visually impaired people shall be provided and/or the level crossing shall be operated for a safe crossing of visually impaired people.
- (4) If any of the above requirements cannot be met, the level track crossing shall not be considered part of a step-free route or of an obstacle-free route.

4.2.2 Rolling Stock Subsystem

- (1) In light of the essential requirements in Section 3, the functional and technical specifications of the subsystem rolling stock related to accessibility for persons with disabilities and persons with reduced mobility are arranged as follows:
- Seats,
 - Wheelchair spaces,
 - Doors,
 - Lighting,
 - Toilets,
 - Clearways,
 - Customer information,
 - Height changes,
 - Handrails,
 - Wheelchair accessible sleeping accommodation,
 - Step position for vehicle access and egress.

4.2.2.1 Seats

4.2.2.1.1 General

- (1) Handholds or vertical handrails or other items that can be used for personal stability, whilst using the aisle, shall be provided on all aisle-side seats unless the seat, when in the upright position, is within 200 mm of:
- the back of another seat facing in the opposite direction which is fitted at its aisle side with a handhold or a vertical handrail or other items that can be used for personal stability,
 - a handrail or a partition provided at the aisle side of the seat.
- (2) Handholds or other items that can be used for personal stability shall be positioned at a height of between 800 mm and 1200 mm above the floor, measured from the centre of the usable part of the handhold, shall not protrude into the clearway and shall contrast with the seat.

| | | | |
|---|--|--------------------|------------------|
|  OTIF | Uniform Technical Prescription | | UTP PRM |
| | Accessibility for persons with disabilities and persons with reduced mobility | | Page 22 of 86 |
| Status: PROPOSAL | | TECH-25004 Annex 2 | Original: EN |
| | | | Date: 24.02.2025 |

- (3) In seating areas with fixed longitudinal seats, handrails shall be used for personal stability. These handrails shall be at a maximum distance of 2000 mm apart, shall be positioned at a height of between 800 mm and 1200 mm above the floor and shall contrast with the vehicle interior surroundings.
- (4) The handholds or other items shall not have sharp edges.

4.2.2.1.2 *Priority seats*

4.2.2.1.2.1 *General*

- (1) Not less than 10 percent of the seats by fixed trainset or individual vehicle, and by class shall be designated as priority seats for the use of persons with disabilities and persons with reduced mobility.
- (2) The priority seats and vehicles containing them shall be identified by signs complying with Appendix N. It shall be stated that other passengers shall make such seats available to those who are eligible to use them when required. Such identification is not required for units intended to be operated exclusively within a seat reservation system: this shall be reported in the technical documentation referred to in point 4.2.12 of the UTP LOC&PAS.
- (3) The priority seats shall be located within the passenger saloon and in close proximity to external doors. In double deck vehicles or trainsets, priority seats can be present on both decks.
- (4) The level of equipment fitted to the priority seats shall, as a minimum, be the same as that fitted to general seats of the same type.
- (5) When seats of a certain type are fitted with armrests, priority seats of the same type shall be fitted with movable armrests, this excludes armrests placed along the vehicle body side or along a partition wall in case of compartments. The movable armrest shall move into a position in line with the seat back cushion to enable unrestricted access to the seat or to any adjacent priority seats.
- (6) Priority seats shall not be tip-up seats.
- (7) Each priority seat and the space available to its user shall comply with the specification referenced in Appendix A, Index [16].
- (8) The whole useful sitting surface of the priority seat shall be a minimum of 450 mm wide (see specification referenced in Appendix A, Index [16]).
- (9) The top of each priority seat cushion shall be between 430 and 500 mm above floor level at the front edge of the seat.
- (10) The clear headroom above each seat shall be at least 1680 mm from floor level, except on double-decker trains on which luggage racks are provided above the seats. In such case reduced headroom of 1520 mm is permitted for priority seats underneath the luggage racks, provided that at least 50 % of priority seats maintain headroom of 1680 mm.
- (11) Where reclining seats are fitted, the dimensions shall be measured when the seats are in their fully upright position.

| | | | |
|---|--|--------------------|------------------|
|  OTIF | Uniform Technical Prescription | | UTP PRM |
| | Accessibility for persons with disabilities and persons with reduced mobility | | Page 23 of 86 |
| Status: PROPOSAL | | TECH-25004 Annex 2 | Original: EN |
| | | | Date: 24.02.2025 |

4.2.2.1.2.2 Uni-directional seats

- (1) Where uni-directional priority seats are provided, the clearance in front of each seat shall comply with the specification referenced in Appendix A, Index [16].
- (2) The distance between the front surface of the seat back and the vertical plane through the rearmost part of the seat in front shall be a minimum of 680 mm, noting that the required seat pitch shall be measured from the centre of the seat 70 mm above where the cushion meets the back support.
- (3) There shall also be a clear space between the front edge of the seat cushion and the same vertical plane for the seat in front of a minimum of 230 mm.

4.2.2.1.2.3 Facing seats arrangement

- (1) Where facing priority seats are provided, the distance between the front edges of the seat cushions shall be a minimum of 600 mm (See the specification referenced in Appendix A, Index [16]). Such distance shall be maintained even if one of the facing seats is not a priority seat.
- (2) Where facing priority seats are equipped with a table, there shall be a minimum clear horizontal distance between the front edge of the seat cushion and the leading edge of the table of at least 230 mm (See the specification referenced in Appendix A, Index [16]). When one of the facing seats is not a priority seat, its distance to the table can be reduced provided that the distance between the front edges of the seat cushions remains 600 mm. Sidewall mounted tables the length of which does not extend over the centre line of the window seat do not need to be considered for conformity with this point.

4.2.2.2 Wheelchair spaces

- (1) According to the length of the unit, excluding the locomotive or power head, there shall be in that unit not less than the number of accessible wheelchair spaces shown in the following table:

Table 5: Minimum number of wheelchair spaces per unit length

| Unit length | Number of wheelchair spaces by unit |
|-----------------------------|--|
| Less than 30 m | 1 wheelchair space |
| 30 to 205 metres | 2 wheelchair spaces |
| More than 205 to 300 metres | 3 wheelchair spaces |
| More than 300 metres | 4 wheelchair spaces |

- (2) To ensure stability, the wheelchair space shall be designed for the wheelchair to be positioned either facing or back to the direction of travel.
- (3) Over the full length of the wheelchair space the width shall be 700 mm from floor level to a minimum height of 1450 mm with an additional 50 mm width to give clearance for hands on each side that is adjacent to any obstacle that will inhibit clearance for the wheelchair users hands (e.g. wall or structure)

| | | | |
|---|--|--------------------|------------------|
|  OTIF | Uniform Technical Prescription | | UTP PRM |
| | Accessibility for persons with disabilities and persons with reduced mobility | | Page 24 of 86 |
| Status: PROPOSAL | | TECH-25004 Annex 2 | Original: EN |
| | | | Date: 24.02.2025 |

from a height of 400 mm to 800 mm above floor level (if one side of the wheelchair is adjacent to the aisle there is no additional 50 mm requirement for that side of the wheelchair as it is already free space)

- (4) The minimum distance in the longitudinal plane between the back of the wheelchair space and the next surface shall be in accordance with the specification referenced in Appendix A, Index [16].
- (5) There shall be no obstruction of the designated space between the floor and the ceiling of the vehicle other than an overhead luggage rack, a horizontal handrail in accordance with the requirements of point 4.2.2.9 attached to the wall or ceiling of the vehicle, or a table.
- (6) The back of the wheelchair space shall be a structure or other acceptable fitting of at least 700 mm wide. The height of the structure, or fitting, shall be capable of preventing a wheelchair that has been positioned with its back against the structure or fitting, from tipping over backwards.
- (7) Tip-up seats may be installed in the wheelchair space but, when in the stowed position, shall not encroach on the dimensional requirements of the wheelchair space.
- (8) There shall be no equipment such as bicycle hooks or ski racks in the wheelchair space or directly in front of it.
- (9) At least one seat shall be available either side-by-side with or facing each of the wheelchair spaces for a companion to travel with the wheelchair user. This seat shall offer the same level of comfort as the other passenger seats, and may also be situated on the opposing side of the aisle.
- (10) On trains with a design speed higher than 250 km/h excepting double deck trains, it shall be possible for a wheelchair user occupying a wheelchair space to transfer onto a passenger seat that shall be equipped with a movable armrest. Such transfer is made by the wheelchair user in autonomy. In that case, it is allowed that the companion seat is shifted to another row. This requirement is applicable up to the number of wheelchair spaces per unit specified in table 5.
- (11) The wheelchair space shall be fitted with a call for aid device that shall, in the event of danger, provide to a wheelchair user the possibility to inform a person who can take appropriate action.
- (12) The call for aid device shall be placed within the comfortable reach range of the person using the wheelchair as shown in the specification referenced in Appendix A, Index [9].
- (13) The call for aid device shall not be placed within a narrow recess which prevents immediate intentional palm operation but can be protected from unintentional use.
- (14) The interface of the call for aid device shall be as set out in point 5.3.2.6.
- (15) A sign conforming to Appendix N shall be placed immediately next to, or in the wheelchair space so as to identify the space as the wheelchair space.

4.2.2.3 Doors

4.2.2.3.1 General

- (1) These requirements apply only to doors providing access to another public part of the train, with the exclusion of toilet doors.

| | | | |
|---|--|--------------------|------------------|
|  OTIF | Uniform Technical Prescription | | UTP PRM |
| | Accessibility for persons with disabilities and persons with reduced mobility | | Page 25 of 86 |
| Status: PROPOSAL | | TECH-25004 Annex 2 | Original: EN |
| | | | Date: 24.02.2025 |

- (2) To latch or unlatch a manually operated door, for use by the public, the control device shall be operable by the palm of the hand exerting a force not exceeding 20 N.
- (3) Door controls, whether manual, pushbuttons or other devices, shall contrast with the surface on which they are mounted.
- (4) Their interface with passengers shall comply with the specifications of point 5.3.2.1.
- (5) If both open and closed door control devices are fitted one above the other, the top device shall always be the open control.

4.2.2.3.2 Exterior doors

- (1) All exterior passenger doorways shall have a minimum clear usable width of 800 mm when open.
- (2) On trains with a design speed lower than 250 km/h, wheelchair access doors offering a level access as defined in point 2.3 shall have a minimum clear usable width of 1000 mm when open.
- (3) All exterior passenger doorways shall be marked on the outside in a way that gives a contrast to the vehicle body-side surrounding them.
- (4) The designated wheelchair exterior accessible doorways shall be the closest doorways to the designated wheelchair spaces.
- (5) The doors to be used for wheelchair access shall be clearly labelled with a sign in accordance with Appendix N.
- (6) From the inside of the vehicle the position of external doorways shall clearly be marked by use of contrasted adjacent flooring.
- (7) Audible and visible signals shall be given to persons inside and outside the train when doors are operated or about to operate.
- (8) The door operating signals are the following:
 - when a door is released for opening, a door opening signal shall be given; it shall last a minimum of 5 seconds unless the door is operated, in which case it may cease after 3 seconds;
 - when a door is automatically or remotely opened by the driver or other member of the train crew, a door opening signal shall be given; it shall last a minimum of 3 seconds from the moment that the door starts to open;
 - when a door that is automatically or remotely closed is about to operate, a door closing signal shall be given; it shall start a minimum of 2 seconds before the door starts to close and shall continue until the door is closed;
 - when a door is closed locally (by a passenger or crew), a door closing signal shall be given; it shall start following the operation of the control device and shall continue until the door is closed.

The audible and visible door closing signal can be omitted when a door is closing for reasons other than departure if alternative means are in place to mitigate the risk of injury to the passengers and the train

| | | | |
|---|--|--------------------|------------------|
|  OTIF | Uniform Technical Prescription | | UTP PRM |
| | Accessibility for persons with disabilities and persons with reduced mobility | | Page 26 of 86 |
| Status: PROPOSAL | | TECH-25004 Annex 2 | Original: EN |
| | | | Date: 24.02.2025 |

crew. The provision of audible and visible door closing signals or of the alternative means shall be equally accepted in all Contracting States.

- (9) The audible door opening signal for persons outside the train can be omitted when a door finding signal is provided. A door finding signal shall sound continuously whilst the door is released or available to be opened, or both.
- (10) The sound source for door signals shall be in the area local to the control device.
If there is no control device, the sound source for door signals shall be located adjacent to the doorway.
If a separate sound source is used for the door closing signal, it can be either local to the control device or adjacent to the doorway.
If an external door finding signal is provided, its sound source shall be located in the area local to the control device, and the sound source for the door closing signal shall be located in the area adjacent to the doorway.
- (11) The visible signals shall be visible from inside and outside the train and shall be located such that they minimise the opportunity for them to be obscured by passengers located in the vestibule. Visible signals shall be in accordance with the specification referenced in Appendix A, Index [19].
- (12) Passenger doors audible signals shall be in accordance with the specification in Appendix G.
- (13) The method of door activation shall be by train crew, semi-automatic (for instance, passenger pushbutton operation) or automatic.
- (14) The door control shall be located either next to or on the door leaf.
- (15) The centre of exterior door opening control, operable from the platform, shall be not less than 800 mm and not more than 1200 mm measured vertically above platforms, for all platforms for which the train is designed. If the train is designed for a single platform height, the centre of exterior door opening control shall be not less than 800 mm and not more than 1100 mm measured vertically above that platform height.
- (16) The centre of internal door opening control for the exterior door shall be not less than 800 mm and not more than 1100 mm measured vertically above the vehicle floor level.

4.2.2.3.3 Interior doors

- (1) Internal automatic and semi-automatic doors shall incorporate devices that prevent passengers becoming trapped during operation of the doors.
- (2) Interior doors that are made available for wheelchair users shall have a minimum clear usable width of 800 mm.
- (3) The force required to open or close a manual door shall not exceed 60 N.
- (4) The centre of interior door controls shall be not less than 800 mm and not more than 1100 mm measured vertically above the vehicle floor level.

| | | | |
|---|--|--------------------|------------------|
|  OTIF | Uniform Technical Prescription | | UTP PRM |
| | Accessibility for persons with disabilities and persons with reduced mobility | | Page 27 of 86 |
| Status: PROPOSAL | | TECH-25004 Annex 2 | Original: EN |
| | | | Date: 24.02.2025 |

- (5) Automatic inter-vehicle connecting doors shall operate either synchronously as a pair, or the second door shall automatically detect the person moving towards it and open.
- (6) If more than 75 % of a door's surface is made of a transparent material, it shall be clearly marked with visual indicators.

4.2.2.4 Lighting

- (1) Minimum values of average illuminance in the passenger areas shall be in accordance with the specification referenced in Appendix A, Index [6]. Requirements relative to the uniformity of these values are not applicable for conformity with this UTP.

4.2.2.5 Toilets

- (1) When toilets are fitted in a train, a universal toilet shall be provided accessible from the wheelchair space.
- (2) The standard toilet shall be compliant with the requirements of points 5.3.2.2 and 5.3.2.3.
- (3) The universal toilet shall be compliant with the requirements of points 5.3.2.2 and 5.3.2.4.
- (4) When toilets are fitted in a train a baby nappy changing facility shall be provided. If separate nursery facilities are not provided or if separate nursery facilities are provided but are not accessible to a wheelchair user, a table shall be incorporated within the universal toilets. It shall be compliant with the requirements of point 5.3.2.5.

4.2.2.6 Clearways

- (1) From the vehicle entrance, the following section of the clearway shall be in accordance with the specification referenced in Appendix A, Index [17]:
 - through the vehicles,
 - between connecting vehicles of a single trainset,
 - to and from wheelchair accessible doors, wheelchair spaces and wheelchair accessible areas including sleeping accommodation and universal toilets if provided.
- (2) The minimum height requirement does not need to be verified in:
 - all areas of double-deck vehicles,
 - gangways and door areas of single deck vehicles.

In those areas, reduced headroom is accepted as a consequence of structural constraints (gauge, physical space).

- (3) A turning space, with a minimum diameter of 1500 mm, shall be provided adjacent to the wheelchair space and in other locations where wheelchairs are supposed to turn 180°. The wheelchair space may be part of the turning circle.
- (4) If a change in direction is required for a wheelchair user, the clearway width of both corridors or corridor and door shall be in accordance with the specification referenced in Appendix A, Index [17].

| | | | |
|---|--|--------------------|------------------|
|  OTIF | Uniform Technical Prescription | | UTP PRM |
| | Accessibility for persons with disabilities and persons with reduced mobility | | Page 28 of 86 |
| Status: PROPOSAL | | TECH-25004 Annex 2 | Original: EN |
| | | | Date: 24.02.2025 |

4.2.2.7 Customer Information

4.2.2.7.1 General

- (1) The following information shall be provided:
 - Safety Information and Safety Instructions,
 - Audible safety instructions coupled with visible signals in case of emergency,
 - Warning, prohibition and mandatory actions signs,
 - Information concerning the route of the train, including information about delays and unplanned stops,
 - Information concerning the location of on-board facilities.
- (2) Visual information referred to in point (1) shall contrast with its background.
- (3) The typeface used for texts referred to in point (1) shall be easily readable.
- (4) Time information presented in digits shall be in the 24h system

4.2.2.7.2 Signage, pictograms and tactile information

- (1) All safety, warning, mandatory action and prohibition signs shall include pictograms and shall be designed according to the specification referenced in Appendix A, index [7].
- (2) There shall be no more than five pictograms, in addition to a directional arrow, indicating a single direction placed adjacent to each other at a single location.
- (3) The following specific pictograms shall be fitted with the wheelchair symbol in accordance with Appendix N:
 - Directional information for wheelchair accessible amenities,
 - Indication of the wheelchair accessible door location outside the train,
 - Indication of the wheelchair space inside the train,
 - Indication of the universal toilets.

The symbols can be combined with other symbols (for example: carriage number, toilet, etc.).

- (4) Where inductive loops are fitted these shall be indicated by a pictogram complying with Appendix N.
- (5) In universal toilets, where hinged handrails are provided, a pictogram showing the rail in both the stowed and deployed positions shall be provided.
- (6) If a vehicle provides reserved seats then the number or letter of that vehicle (as used in the reservation system) shall be displayed externally on or adjacent to all its access doors. The number or letter shall be displayed in characters not less than 70 mm high and shall be visible when the door is open and closed.

| | | | |
|---|--|--------------------|------------------|
|  OTIF | Uniform Technical Prescription | | UTP PRM |
| | Accessibility for persons with disabilities and persons with reduced mobility | | Page 29 of 86 |
| Status: PROPOSAL | | TECH-25004 Annex 2 | Original: EN |
| | | | Date: 24.02.2025 |

- (7) If seats are identified by numbers or letters, the number or letter of the seat shall be displayed on or adjacent to every seat in characters not less than 12 mm high. Such numbers and letters shall contrast with their background.
- (8) Tactile information signage shall be fitted in:
 - Toilets and wheelchair accessible sleeping accommodation, for functional information and call for aid device if appropriate,
 - Rolling stock, for the open/close button of passenger accessible doors and call for aid devices.

4.2.2.7.3 *Dynamic Visual Information*

- (1) The final destination or route shall be displayed on the outside of the train on the platform side adjacent to at least one of the passenger access doors on at least alternate vehicles of the train.
- (2) Where trains operate in a system, in which dynamic visual information is given on the station platform every 50 m or less, and destination or route information is also provided on the front of the train, it is not mandatory to provide information on the sides of vehicles.
- (3) The final destination or route of the train shall be displayed inside each vehicle.
- (4) The next stop of the train shall be displayed such that it can be read from at least 51 % of passenger seats inside each vehicle including 51 % of the priority seats, and from all wheelchair spaces.
- (5) The dynamic visual information system shall have be able to display the next stop of the train at least two minutes before arrival at the station concerned. If the next station is less than two minutes planned journey time away, the system shall be able to display the next station immediately following departure from the previous station.
- (6) The requirement in point (4) does not apply to compartment carriages where the compartments have a maximum of 8 seats and are served by an adjacent corridor. However, that information shall be visible to a person standing in a corridor outside a compartment and to a passenger occupying a wheelchair space.
- (7) The dynamic visual information system may display information about the next stop on the same support as the final destination.
- (8) If the system is automated, it shall be possible to suppress or correct incorrect or misleading information.
- (9) Internal and external displays shall comply with the requirements of points (10) and (13). In those points, the term “display” shall be understood as any support of dynamic information.
- (10) Each station name (which may be abbreviated), or words of messages, shall be displayed for a minimum of 2 seconds.
- (11) If a scrolling display is used (either horizontal or vertical), each complete word shall be displayed for a minimum of 2 seconds and the horizontal scrolling speed shall not exceed an average of 6 characters per second.

| | | | |
|---|--|--------------------|------------------|
|  OTIF | Uniform Technical Prescription | | UTP PRM |
| | Accessibility for persons with disabilities and persons with reduced mobility | | Page 30 of 86 |
| Status: PROPOSAL | | TECH-25004 Annex 2 | Original: EN |
| | | | Date: 24.02.2025 |

- (12) On external displays the minimum character height shall be 70 mm on front displays and 35 mm on side displays.
- (13) Internal displays shall be designed for a maximum viewing distance in accordance with the formula in Table 5a.

Table 5a: Maximum viewing distance of the internal displays for rolling stock

| Reading distance | Character height |
|-------------------------|---------------------------|
| < 8750 mm | (reading distance/250) mm |
| 8750 to 10 000 mm | 35 mm |
| > 10 000mm | (reading distance/285) mm |

4.2.2.7.4 *Dynamic audible information*

- (1) The train shall be fitted with a public address system which shall be used either for routine or emergency announcements by the driver or by another crew member who has specific responsibility for passengers.
- (2) The public address system may operate on a manual, an automated or pre-programmed basis. If the public address system is automated, it shall be possible to suppress, or correct, incorrect or misleading information.
- (3) The public address system shall be capable of announcing the destination and next stop of the train at each stop, or on departure from each stop.
- (4) The public address system shall be capable of announcing the next stop of the train at least two minutes before the arrival of the train at that stop. If the next station is less than two minutes planned journey time away, the next station shall be announced immediately following departure from the previous station.
- (5) The spoken information shall have a minimum STI-PA level of 0.45, in accordance with the specification referenced in Appendix A, index [5]. The public address system shall meet the requirement at all seat locations and wheelchair spaces.

4.2.2.8 *Height changes*

- (1) Internal steps (other than those for external access) shall have a maximum height of 200 mm and a minimum depth of 280 mm, measured at the central axis of the stairs. For double deck trains it is permitted to reduce this value to 270 mm for the stairs accessing the upper deck and the lower deck.
- (2) As a minimum, the first and the last steps shall be indicated by a contrasting band extending the full width of the steps on both the front and the top surfaces of the step nosing with a depth of:
 - 45 mm to 55 mm on the front surface,
 - 45 mm to 75 mm on the top surface.

| | | | |
|---|--|--------------------|------------------|
|  OTIF | Uniform Technical Prescription | | UTP PRM |
| | Accessibility for persons with disabilities and persons with reduced mobility | | Page 31 of 86 |
| Status: PROPOSAL | | TECH-25004 Annex 2 | Original: EN |
| | | | Date: 24.02.2025 |

- (3) Stairs constituted of more than three steps shall be provided with handrails on both sides and at two levels. The higher handrail shall be positioned at a height of 850 mm to 1000 mm above floor level. The lower handrail shall be positioned at a height of 500 mm to 750 mm above floor level.
- (4) Stairs constituted of one, two or three steps shall be provided on both sides with a minimum of one handrail or other item that can be used for personal stability.
- (5) Handrails shall be compliant with point 4.2.2.9.
- (6) No steps are allowed between the vestibule of a wheelchair accessible exterior door, the wheelchair space, a universal sleeping compartment and the universal toilet except for a door threshold strip that shall not exceed 15 mm in height or except in case that a lift is provided to overcome the step. The lift shall comply with the requirements of point 5.3.2.10.
- (7) For ramps in rolling stock the maximum slope shall not exceed the following values:

Table 6: Maximum slope for ramps in rolling stock

| <u>Length of ramp</u> | <u>Maximum gradient (degrees)</u> | <u>Maximum gradient (%)</u> |
|---|-----------------------------------|-----------------------------|
| Paths between a wheelchair accessible exterior door, the wheelchair space, a wheelchair accessible sleeping accommodation and the universal toilet. | | |
| Up to 840 mm in single deck carriages | 6,84 | 12 |
| Up to 840 mm in double deck carriages | 8,5 | 15 |
| > 840 mm | 3,58 | 6,25 |
| Other areas of the train | | |
| > 1000 mm | 6.84 | 12 |
| 600 mm to 1000 mm | 8,5 | 15 |
| Less than 600 mm | 10,2 | 18 |

Note: These gradients shall be measured when the vehicle is stationary on straight and level track.

4.2.2.9 Handrails

- (1) All handrails fitted to a vehicle shall be round in section with an outside diameter of 30 mm to 40 mm, and shall have a minimum clear distance of 45 mm to any adjacent surface other than its mountings.
- (2) If a handrail is curved, the radius to the inside face of the curve shall be a minimum of 50 mm.

| | | | |
|---|--|--------------------|------------------|
|  OTIF | Uniform Technical Prescription | | UTP PRM |
| | Accessibility for persons with disabilities and persons with reduced mobility | | Page 32 of 86 |
| Status: PROPOSAL | | TECH-25004 Annex 2 | Original: EN |
| | | | Date: 24.02.2025 |

- (3) All handrails shall contrast with their background.
- (4) External doorways shall be provided with handrails on both sides, fitted internally as close as practicable to the vehicle outer wall. Exception can be made for one side of the doorway if it is fitted with a device such as an on-board lift.
- (5) The handrails referred to in point (4) shall be:
 - vertical handrails that shall extend from 700 mm to 1200 mm above the threshold of the first step for all external doorways,
 - additional handrails at a height of between 800 mm and 900 mm above the first usable step and parallel with the line of the step nosing for doorways with more than two entrance steps.
- (6) Where the clearway of the gangway is narrower than 1000 mm and longer than 2000 mm there shall be handrails or handholds provided in, or adjacent to, inter-vehicle gangways that are provided for passenger use.
- (7) Where the clearway of the gangway is wider than or equal to 1000 mm handrails or handholds shall be provided in the gangway.

4.2.2.10 Wheelchair accessible sleeping accommodation

- (1) When a train is equipped with sleeping accommodation for passengers, it shall provide a vehicle containing at least one wheelchair accessible sleeping accommodation.
- (2) If there is more than one vehicle with sleeping accommodation for passengers in a train, there shall be not less than two wheelchair accessible sleeping accommodations in the train.
- (3) If a rail vehicle provides wheelchair accessible sleeping accommodation, the exterior of the relevant vehicle door and the wheelchair accessible sleeping accommodation door shall be marked with a sign in accordance with Appendix N.
- (4) The wheelchair accessible sleeping accommodation internal space shall take in consideration the requirements of point 4.2.2.6 for actions expected from the wheelchair user in the sleeping accommodation.
- (5) The sleeping accommodation shall be fitted with not less than two call for aid devices that shall when operated, send a signal to a person who can take appropriate action; they need not initiate a communication.
- (6) The interface of the call for aid devices shall be as defined in point 5.3.2.6.
- (7) One call for aid device shall be placed not more than 450 mm above the floor, measured vertically from the surface of the floor to the centre of the control. It shall be positioned so that the control can be reached by a person lying on the floor.
- (8) The other call for aid device shall be not less than 600 mm and not more than 800 mm above the floor measured vertically to the centre of the control.

| | | | |
|---|--|--------------------|------------------|
|  OTIF | Uniform Technical Prescription | | UTP PRM |
| | Accessibility for persons with disabilities and persons with reduced mobility | | Page 33 of 86 |
| Status: PROPOSAL | | TECH-25004 Annex 2 | Original: EN |
| | | | Date: 24.02.2025 |

- (9) The call for aid devices described in points (7) and (8) shall be located on different vertical surfaces of the sleeping accommodation.
- (10) The call for aid devices shall be distinct from any other control within the sleeping accommodation, be coloured differently from other control devices and contrast with their background.

4.2.2.11 Step position for vehicle access and egress

4.2.2.11.1 General requirements

- (1) It shall be demonstrated that the point situated in the central position on the nose of the access step of each passenger access door on both sides of a vehicle in working order with new wheels standing centrally on the rails, shall be located inside the surface identified as "step location" on the figure 1 below.

Figure 1

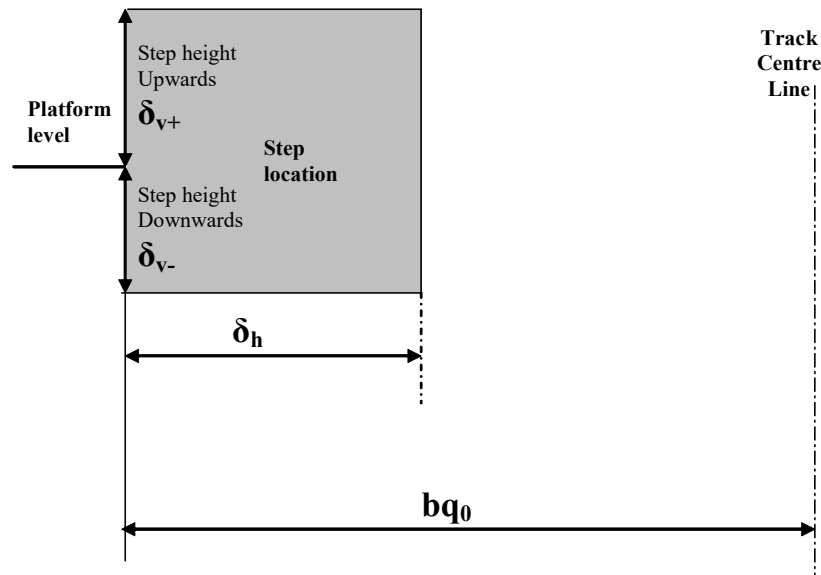

- (2) The values of bq_0 , δ_h , δ_{v+} and δ_{v-} depend on the type of platform where the rolling stock is intended to stop. They shall be as follows:

- bq_0 shall be calculated based on the gauge of the track in which the train is intended to operate in accordance with the specification referenced in Appendix A, index [8].

The calculation shall take into account the loading gauge(s) on which the vehicle is designed to be operated.

Gauges are defined in chapter 4.2.3.1 of INF TSI.

- δ_h , δ_{v+} and δ_{v-} are defined in tables 7 – 9.

| | | | |
|---|--|--------------------|------------------|
|  OTIF | Uniform Technical Prescription | | UTP PRM |
| | Accessibility for persons with disabilities and persons with reduced mobility | | Page 34 of 86 |
| Status: PROPOSAL | | TECH-25004 Annex 2 | Original: EN |
| | | | Date: 24.02.2025 |

Table 7 for all rolling stock intended to stop, in normal operation, at platforms of 550 mm height:

Table 7: Values of δ_h , δ_{v+} and δ_{v-} for a 550 mm platform

| | δ_h mm | δ_{v+} mm | δ_{v-} mm |
|---|---------------|------------------|------------------|
| on a straight level track | 200 | 230 | 160 |
| on a track with a curve radius of 300 m | 290 | 230 | 160 |

Table 8 for all rolling stock intended to stop, in normal operation, at platforms of 760 mm height:

Table 8: Values of δ_h , δ_{v+} and δ_{v-} for a 760 mm platform

| | δ_h mm | δ_{v+} mm | δ_{v-} mm |
|--|---------------|------------------|------------------|
| on a straight level track | 200 | 230 | 160 |
| on a track with a curve radius of 300m | 290 | 230 | 160 |

Table 9 for all rolling stock intended to stop, in normal operation, at both platforms of 760 mm height and platforms of 550 mm height, and having two or more access steps:

For one step, values of the table 7 above apply, and for the next step towards the vehicle interior the following values apply, based upon a nominal platform height of 760 mm:

Table 9: Values of δ_h , δ_{v+} and δ_{v-} for the second step for a 760 mm platform

| | δ_h mm | δ_{v+} mm | δ_{v-} mm |
|---|---------------|------------------|------------------|
| on a straight level track | 380 | 230 | 160 |
| on a track with a curve radius of 300 m | 470 | 230 | 160 |

- (3) The technical documentation referred in point 4.2.12 of the UTP LOC&PAS shall include information about:
- the height and offset of the theoretical platform resulting in a vertical gap (δ_{v+}) of 230 mm and in a horizontal gap (δ_h) of 200 mm from the point situated in the central position of the nose of the rolling stock's lowest step on a straight level track,
 - the height and offset of the theoretical platform resulting in a vertical gap (δ_{v-}) of 160 mm and in a horizontal gap (δ_h) of 200 mm from the point situated in the central position of the nose of the rolling stock's lowest step on a straight level track.

4.2.2.11.2 Access/egress steps

- (1) All steps for access and egress shall be slip resistant and shall have an effective clear width as large as the doorway width.

| | | | |
|---|--|--------------------|------------------|
|  OTIF | Uniform Technical Prescription | | UTP PRM |
| | Accessibility for persons with disabilities and persons with reduced mobility | | Page 35 of 86 |
| Status: PROPOSAL | | TECH-25004 Annex 2 | Original: EN |
| | | | Date: 24.02.2025 |

- (2) Internal steps for external access shall have a minimum depth of 240 mm between the vertical edges of the step and a maximum height of 200 mm. The height of each step may be increased to a maximum of 230 mm if it can be demonstrated that this achieves a reduction of one in the total number of steps required.
- (3) The rising height of each step shall be equal.
- (4) As a minimum the first and the last steps shall be indicated by a contrasting band with a depth of 45 mm to 55 mm extending a minimum of 80 % of the width of the steps on the top surface of the step nosing. A similar band shall indicate the front surface of the last step when entering the unit.
- (5) An external access step, fixed or moveable, shall have a maximum height of 230 mm between steps and a minimum depth of 150 mm.
- (6) If a step board is fitted and it is an extension of a door sill outside the vehicle, and there is no change in level between the step board and the floor of the vehicle, this shall not be considered to be a step for the purposes of this specification. A minimal drop in level, with a maximum of 60 mm, between the floor surface at door sill and that of the exterior of the vehicle, used to guide and seal the door is also permissible and shall not be considered as a step.
- (7) Access to the vestibule shall be achieved with a maximum of 4 steps of which one may be external.
- (8) Rolling stock intended to stop, in normal operation, at existing platforms below 380 mm height and having their passenger access doors above bogies need not comply with points (2) and (5) above if it can be demonstrated that this achieves a more even distribution of the steps heights.

4.2.2.12 Boarding aids

- (1) A secure storage system shall be provided to ensure that boarding aids, including portable ramps, do not impinge on a passenger's wheelchair or mobility aid or pose any hazard to passengers in the event of a sudden stop.
- (2) The following types of boarding aids may be present in the rolling stock according to the rules defined in point 4.4.3.

4.2.2.12.1 Movable step and bridging plate

- (1) A moveable step is a retractable device integrated into the vehicle lower than the door threshold level, fully automatic and activated in conjunction with the door opening/closing sequences.
- (2) A bridging plate is a retractable device integrated into the vehicle as close as possible to the door threshold level, fully automatic and activated in conjunction with the door opening/closing sequences.
- (3) (Reserved).
- (4) The extension of the moveable step or bridging plate shall be completed before the door opening permits the passengers to cross and conversely, removal of the step or plate may only begin when the door opening no longer permits any crossing of passengers.
- (5) Movable steps and bridging plates shall comply with the requirements of point 5.3.2.8.

| | | | | |
|---|--|--------------------|---------------|------------------|
|  OTIF | Uniform Technical Prescription | | UTP PRM | |
| | Accessibility for persons with disabilities and persons with reduced mobility | | Page 36 of 86 | |
| Status: PROPOSAL | | TECH-25004 Annex 2 | Original: EN | Date: 24.02.2025 |

4.2.2.12.2 On-board ramp

- (1) An on-board ramp is a device that is positioned between the vehicle door threshold and the platform. It can be manual, semi-automatic or automatic.
- (2) On-board ramps shall comply with the requirements of point 5.3.2.9.

4.2.2.12.3 On-board lift

- (1) An on-board lift is a device integrated in the doorway area of a vehicle that shall be able to overcome the maximum height difference between the vehicle floor and the station platform where operated.
- (2) When the lift is in the stowed position, the doorway shall have a minimum usable width in accordance with point 4.2.2.3.2.
- (3) On-board lifts shall comply with the requirements of point 5.3.2.10.

4.3 Functional and technical specifications of the interfaces

The tables in section 4.3 are in a 5 column layout. The first column on the left hand side appears only in this UTP and not in EU law, to help explain the legal reference under COTIF.

4.3.1 Interfaces with the infrastructure subsystem

Table 10: Interface with the infrastructure subsystem

| <i>Reference to the COTIF provisions</i> | <i>Interface with the infrastructure subsystem</i> | | | |
|--|--|--------------|--------------------------------|--------------|
| | UTP PRM | | UTP INF | |
| | Parameter | Point | Parameter | Point |
| In accordance with Article 6 § 2 of the ATMF UR and with the UTP TCRC, it is the responsibility of the railway undertaking to ensure the compatibility of the vehicle with the infrastructure it is operated on. | Step position for vehicle access and egress | 4.2.2.11 | Platforms | 4.2.9 |
| | Specific cases about the step position for vehicle access and egress | 7.3.2 | Specific cases about platforms | 7.7 |

| | | | |
|---|--|--------------------|------------------|
|  OTIF | Uniform Technical Prescription | | UTP PRM |
| | Accessibility for persons with disabilities and persons with reduced mobility | | Page 37 of 86 |
| Status: PROPOSAL | | TECH-25004 Annex 2 | Original: EN |
| | | | Date: 24.02.2025 |

4.3.2 Interfaces with the rolling stock subsystem

Table 11: Interface with the rolling stock subsystem

| <i>Reference to the COTIF provisions</i> | <i>Interface with the rolling stock subsystem</i> | | | |
|--|--|-------------|-------------------------|-----------|
| | UTP PRM | | UTP LOC&PAS | |
| | Parameter | Point | Parameter | Point |
| Set out by the UTP LOC&PAS (Point 4.2.5) and by this UTP | Rolling stock subsystem | 4.2.2 | Passenger related items | 4.2.5 |
| | Rolling stock intended to be operated exclusively within a seat reservation system | 4.2.2.1.2.1 | General documentation | 4.2.12.2 |
| | Height and offset of theoretical platforms | 4.2.2.11.1 | General documentation | 4.2.12.2 |
| | Movable step and bridging plate | 4.2.2.12.1 | Door-traction interlock | 4.2.5.5.7 |

4.3.3 Interfaces with the Telematics Applications for Passengers subsystem

Table 12: Interface with the Telematics Applications for Passengers subsystem⁴

| <i>Reference to the COTIF provisions-</i> | <i>Interface with the TAP subsystem</i> | | | |
|--|---|-------|---|--|
| | UTP PRM | | Telematics applications | |
| | Parameter | Point | Parameter | |
| TAP is included in the functional subsystems of the UTP GEN-B. However, there are no harmonised COTIF requirements for telematics applications for passengers. | Station accessibility Assistance to board and alight the train | 4.4.1 | Handling of information concerning carriage and assistance of persons with disabilities and persons with reduced mobility | |

⁴ TAP TSI means Commission Regulation (EU) No 454/2011 of 5 May 2011 as last amended by Commission Implementing Regulation (EU) 2019/775 of 16 May 2019 on the technical specification for interoperability relating to the subsystem 'telematics applications for passenger services'. The references to the TAP TSI are set out in Table 12 of the PRM TSI.

| | | | |
|---|--|--------------------|------------------|
|  OTIF | Uniform Technical Prescription | | UTP PRM |
| | Accessibility for persons with disabilities and persons with reduced mobility | | Page 38 of 86 |
| Status: PROPOSAL | | TECH-25004 Annex 2 | Original: EN |
| | | | Date: 24.02.2025 |

| <i>Reference to the COTIF provisions-</i> | <i>Interface with the TAP subsystem</i> | | | |
|--|--|----------|---|--|
| | UTP PRM | | Telematics applications | |
| | Parameter | Point | Parameter | |
| <p>Legal provisions which concern telematics applications for passengers may apply in Contracting States, including the TAP TSI in states which apply EU law. It is the responsibility of the railway undertaking that uses the vehicles to ensure that the interfaces function in compliance with the applicable rules.</p> | Assistance to board and alight the train | 4.4.2 | Handling of information concerning carriage and assistance of persons with disabilities and persons with reduced mobility | |
| | Access and reservation | 4.4.2 | Handling of availability/reservation | |
| | Visual information | 4.2.1.10 | Handling of information provision in the station area | |
| | Spoken information | 4.2.1.11 | Handling of information provision in the station area | |
| | Customer information | 4.2.2.7 | Handling of information provision in the vehicle area | |
| | | | | |

4.4 Operating rules

When using rolling stock within the scope of this UTP in international traffic, railway undertakings must comply with the rules applicable in the state concerned, including the EU rules reproduced in the right-hand column in states which apply EU law.

In general, operating rules are not harmonised within the scope of this UTP, with the exception of operational rules which are directly related to the vehicles and which are indispensable for the safe and correct use of vehicles in international traffic.

The following operating rules do not form part of the assessment of subsystems.

This TSI does not specify operating rules for evacuation in the case of hazardous situations, only the relevant technical requirements. The purpose of the technical requirements for infrastructure and rolling stock is to facilitate evacuation for all, including persons with disabilities and persons with reduced mobility. The following operating rules apply to the operation of the whole infrastructure and rolling stock subsystems.

4.4.1 Infrastructure subsystem

[reserved]

In light of the essential requirements in section 3, the operating rules specific to the

| | | | |
|---|--|--------------------|------------------|
|  OTIF | Uniform Technical Prescription | | UTP PRM |
| | Accessibility for persons with disabilities and persons with reduced mobility | | Page 39 of 86 |
| Status: PROPOSAL | | TECH-25004 Annex 2 | Original: EN |
| | | | Date: 24.02.2025 |

infrastructure subsystem related to accessibility for persons with disabilities and persons with reduced mobility are as follows:

– General

The infrastructure manager or station manager or railway undertaking shall have a written policy to ensure that all persons with disabilities and persons with reduced mobility can access the passenger infrastructure at all operational times in accordance with the technical requirements of this TSI. Furthermore, the policy shall be compatible with any railway undertaking that may wish to use the facilities, (refer to point 4.4.2) as appropriate. The policy shall be implemented through the provision of adequate information to staff, procedures and training. The Infrastructure policy shall include, but not be limited to, operating rules for the following situations:

– Station Accessibility

Operating rules shall be made to ensure that information regarding the level of accessibility of all stations is available.

– Unstaffed Stations – Ticketing for Visually Impaired Passengers

Operating rules shall be written and implemented with respect to unstaffed stations where vending machines are relied upon for ticketing (refer to point 4.2.1.8). In such situations, an alternative means of ticketing, accessible to visually impaired passengers, shall always be available (for example, permitting purchasing either on the train or at the destination).

– Ticketing Control – Turnstiles

In cases where turnstiles are utilised for ticketing control, operational rules shall be implemented, whereby disabled persons and persons with reduced mobility are offered parallel access through such control points. This special access shall permit wheelchair users, and may be controlled by staff or be automatic.

– Lighting of platforms

It is allowed that lighting be switched off on platforms where no train is expected.

| | | | |
|---|--|--------------------|------------------|
|  OTIF | Uniform Technical Prescription | | UTP PRM |
| | Accessibility for persons with disabilities and persons with reduced mobility | | Page 40 of 86 |
| Status: PROPOSAL | | TECH-25004 Annex 2 | Original: EN |
| | | | Date: 24.02.2025 |

– Visual and Spoken Information –
Achieving Consistency

Operating rules shall be implemented to ensure consistency between essential visual and spoken information (refer to points 4.2.1.10 and 4.2.1.11). Staff making announcements shall follow standard procedures to achieve complete consistency of essential information.

Advertisements shall not be combined with the routing information.

Note: General information about public transport services shall not be considered as advertisements for the purposes of this point.

– On-demand Spoken Passenger Information System

Where spoken information is not provided via a public address system at a station (refer to point 4.2.1.11), operating rules shall be implemented to ensure the provision of an alternative information system, whereby passengers are able to acquire the same information audibly at the station (e.g. a staffed or automated telephone information service).

– Platform – Wheelchair Boarding Aid Operational Zone

The railway undertaking and the infrastructure manager or station manager shall define together the area(s) on the platform where the facility is likely to be used, taking account of train composition variations.

Operational rules shall be implemented to determine, where possible, the stopping point of trains according to the location of this (or these) operational zone(s).

– Safety of Manual and Powered Wheelchair Boarding Aids

Operations rules shall be implemented concerning the operation of boarding aids by station staff (refer to point 4.2.1.14).

An operational rule shall be implemented concerning the use by staff of the moveable safety barrier fitted to wheelchair lifts (refer to point 4.2.1.14).

| | | | |
|---|--|--------------------|------------------|
|  OTIF | Uniform Technical Prescription | | UTP PRM |
| | Accessibility for persons with disabilities and persons with reduced mobility | | Page 41 of 86 |
| Status: PROPOSAL | | TECH-25004 Annex 2 | Original: EN |
| | | | Date: 24.02.2025 |

Operational rules shall be implemented to ensure that staff is able to safely operate boarding ramps, with respect to deployment, securing, raising, lowering and stowing (refer to point 4.2.1.14).

- Assistance to board and alight the train

Operational rules shall be implemented to ensure that staff are aware that persons with disabilities and persons with reduced mobility may require assistance to board and alight the train, and shall provide such assistance if required.

Conditions on which assistance to persons with disabilities and persons with reduced mobility is provided are defined in Regulation (EU) 2021/782 of the European Parliament and of the Council⁵.

- Supervised Level Track Crossing

Where supervised level track crossing is permitted, operating rules shall be implemented to ensure that staff at supervised level track crossings give appropriate assistance to persons with disabilities and persons with reduced mobility, including indication of when it is safe to cross the track.

4.4.2 Rolling Stock subsystem

In light of the essential requirements in Chapter 3, the operating rules specific to the rolling stock subsystem related to accessibility for persons with disabilities and persons with reduced mobility are as follows:

4.4.2.1 General

(Reserved)

The railway undertaking shall have a written policy to ensure accessibility to passenger rolling stock at all operational times in accordance with the technical requirements of this TSI. Furthermore, the policy shall be compatible with the infrastructure manager or station manager policy (refer to point 4.4.1) as appropriate. The policy shall be implemented through the provision of adequate information to staff, procedures and training. The rolling stock

⁵ Regulation (EU) 2021/782 of the European Parliament and of the Council of 29 April 2021 on rail passengers' rights and obligations (recast).

| | | | |
|---|--|--------------------|------------------|
|  OTIF | Uniform Technical Prescription | | UTP PRM |
| | Accessibility for persons with disabilities and persons with reduced mobility | | Page 42 of 86 |
| Status: PROPOSAL | | TECH-25004 Annex 2 | Original: EN |
| | | | Date: 24.02.2025 |

policy shall include, but not be limited to, operating rules for the following situations:

4.4.2.2 Access to and Reservation of Priority Seats

(Reserved)

Two possible conditions exist in connection with seats classified as ‘priority’; (i) unreserved and (ii) reserved (refer to point 4.2.2.1.2.1 (2)). In case (i), the operating rules will be directed to other passengers (i.e. provision of signage) requesting them to ensure that priority is given to all persons with disabilities and persons with reduced mobility that are defined as being eligible to use such seats and that occupied priority seats are given-up as appropriate. In case (ii) operating rules shall be implemented by the railway undertaking to ensure that the ticketing reservation system is equitable with regards to persons with disabilities and persons with reduced mobility. Such rules will ensure that priority seating is initially only available for reservation by persons with disabilities and persons with reduced mobility until a given cut-off period prior to departure. After that point in time, priority seats will be made available to the entire passenger population, including persons with disabilities and persons with reduced mobility.

4.4.2.3 Carriage of Assistance Dogs

(Reserved)

Operating rules shall be made to ensure that persons with disabilities and persons with reduced mobility with an assistance dog shall not be charged extra.

4.4.2.4 Access to and Reservation of Wheelchair Spaces

(Reserved)

The priority seating access and reservation rules also apply to wheelchair spaces, with only wheelchair users having priority. Additionally, operating rules shall provide for (i) unreserved or (ii) reserved accompanying persons (non-PRM) seating adjacent or facing the wheelchair space.

4.4.2.5 Access to and Reservation of Universal Sleeping Compartments

(Reserved)

The priority seating reservation rules also apply to universal sleeping compartments (refer to point 4.2.2.10). However, operational rules shall

| | | | |
|---|--|--------------------|------------------|
|  OTIF | Uniform Technical Prescription | | UTP PRM |
| | Accessibility for persons with disabilities and persons with reduced mobility | | Page 43 of 86 |
| Status: PROPOSAL | | TECH-25004 Annex 2 | Original: EN |
| | | | Date: 24.02.2025 |

prevent non-reserved occupation of universal sleeping compartments (i.e. advanced booking will always be necessary).

4.4.2.6 Train crew – exterior door activation

Operational rules shall be implemented regarding the procedure for external door activation by train crew to ensure safety of all passengers including persons with disabilities and persons with reduced mobility (refer to point 4.2.2.3.2).

4.4.2.7 Call for aid device in wheelchair space, universal toilets or wheelchair accessible sleeping accommodation

Operational rules shall be implemented to ensure appropriate response and action from the staff in the event of activation of the call for aid device (refer to points 4.2.2.2, 4.2.2.5 and 4.2.2.10). Response and action need not be the same according to the origin of the call for aid.

4.4.2.8 Lighting

Where every passenger seat is equipped with an individual light, it is permitted to reduce the lighting level in the unit according to the type of operation (e.g. night service, passenger comfort). The requirements of the specification referenced in Appendix A, Index [6], shall be met.

4.4.2.9 Audible safety instructions in case of emergency

Operational rules shall be implemented regarding the transmission of audible safety instructions to passengers in the event of an emergency (refer to point 4.2.2.7.4). Those rules shall include the nature of the instructions and of their transmission.

4.4.2.10 Visual and audible information – Control of advertisements

(Reserved)

Details of the route or network on which the train operates shall be available (the railway undertaking shall decide the manner in which this information is provided).

Advertisements shall not be combined with routing information.

Note: General information about public transport services shall not be considered as advertisements for the purposes of this point.

4.4.2.11 Automatic Information Systems – Manual Correction of incorrect or misleading information

(Reserved)

Operational rules shall be implemented for the validation and ability to correct erroneous automatic information by the train crew (refer to point 4.2.2.7).

| | | | |
|---|--|--------------------|------------------|
|  OTIF | Uniform Technical Prescription | | UTP PRM |
| | Accessibility for persons with disabilities and persons with reduced mobility | | Page 44 of 86 |
| Status: PROPOSAL | | TECH-25004 Annex 2 | Original: EN |
| | | | Date: 24.02.2025 |

4.4.2.12 Rules for announcement of the final destination and the next stop

(Reserved)

Operational rules shall be implemented to ensure that the next stop is announced no later than 2 minutes prior to the event and that the dynamic information displays revert to show the final destination as soon as the train has stopped (refer to point 4.2.2.7).

4.4.2.13 Rules on train composition to make wheelchair boarding aid devices usable according to the arrangement of the platforms

Operation rules shall be implemented to take account of train composition variations such that the safe operational zones for wheelchair boarding aids can be determined with respect to the stopping point of trains.

4.4.2.14 Safety of Manual and Powered Wheelchair Boarding Aids

Operations rules shall be implemented concerning the operation of boarding aids by train and station staff. In the case of manual devices, procedures shall ensure that minimum physical effort is required from staff. In the case of powered devices, procedures shall ensure emergency fail-safe-operation in the event of loss of power. An operational rule shall be implemented concerning the use by train or station staff of the moveable safety barrier fitted to wheelchair lifts.

Operational rules shall be implemented to ensure that train and station staff is able to safely operate boarding ramps, with respect to deployment, securing, raising, lowering and stowing.

4.4.2.15 Assistance to board and alight from the train

Operational rules shall be implemented to ensure that staff are aware that disabled persons and persons with reduced mobility may require assistance to board and alight the train, and shall provide such assistance if required.

Conditions on which assistance to persons with disabilities and persons with reduced mobility is provided are defined in Regulation (EU) 2021/782.

4.4.2.16 Platform – Wheelchair Boarding Aid Operational Zone

(Reserved)

The railway undertaking and the infrastructure manager or station manager shall define together the area on the platform where the facility is likely to be used and shall demonstrate its validity. That area shall be compatible with the existing platforms where the train is likely to stop.

As a consequence, the stopping point of the train shall in some cases be adjusted in order to comply with this requirement.

| | | | |
|---|--|--------------------|------------------|
|  OTIF | Uniform Technical Prescription | | UTP PRM |
| | Accessibility for persons with disabilities and persons with reduced mobility | | Page 45 of 86 |
| Status: PROPOSAL | | TECH-25004 Annex 2 | Original: EN |
| | | | Date: 24.02.2025 |

Operational rules shall be implemented to take account of train composition variations (refer to point 4.2.1.12) so that the stopping point of trains can be determined with respect to the boarding aid operational zones.

4.4.2.17 Emergency method to deploy moveable steps

Operational rules shall be implemented for the emergency stowage or deployment of the bridging plate in the case of power failure.

4.4.2.18 Operating combinations of rolling stock compliant and non-compliant with this UTP

(Reserved)

When forming a train from a mixture of compliant and non-compliant rolling stock, operational procedures shall be implemented to ensure that a minimum of two wheelchair spaces compliant with this TSI are provided on the train. If toilets are available on the train, it shall be ensured that wheelchair users have access to a universal toilet.

Under such rolling stock combinations, procedures shall be in place to ensure that visual and audible route information is available on all vehicles.

It is accepted that dynamic information systems, wheelchair space, universal toilet, wheelchair accessible sleeping accommodation and call for aid devices may not be fully functional when working in such formations.

4.4.2.19 Forming trains from individual vehicles compliant with this UTP

When vehicles that have been individually assessed in accordance with point 6.2.7 are formed into a train, operational procedures shall be in place to ensure that the complete train complies with point 4.2 of this UTP.

4.4.2.20 Providing services on board trains

(Reserved)

When a service is provided to passengers in a specific area of a train that cannot be accessed by wheelchair users, operational means shall be in place to ensure that:

- (a) free of charge assistance is available to assist wheelchair users reach the service; or
- (b) the service is delivered free of charge to wheelchair users at the wheelchair spaces,

| | | | |
|---|--|--------------------|------------------|
|  OTIF | Uniform Technical Prescription | | UTP PRM |
| | Accessibility for persons with disabilities and persons with reduced mobility | | Page 46 of 86 |
| Status: PROPOSAL | | TECH-25004 Annex 2 | Original: EN |
| | | | Date: 24.02.2025 |

unless the nature of the service makes it impossible to provide it remotely.

4.4.3 Provision of boarding aids and provision of assistance

[reserved]

The infrastructure manager or station manager and railway undertaking shall agree the provision and management of the boarding aids as well as the provision of assistance and alternative transport in line with Regulation (EU) 2021/782 in order to establish which party is responsible for the operation of boarding aids and alternative transport. The infrastructure manager (or station manager(s)) and railway undertaking shall ensure that the division of responsibilities they agree is the most viable overall solution.

Such agreements shall take into consideration the area of use of boarding aids referred to in points 5.3.1.2, 5.3.1.3, 5.3.2.9 and 5.3.2.10.

Such agreements shall define:

- (a) the station platforms where a boarding aid has to be operated by the infrastructure manager or the station manager and the rolling stock for which it will be used;
- (b) the station platforms where a boarding aid has to be operated by the railway undertaking and the rolling stock for which it will be used;
- (c) the rolling stock where a boarding aid has to be provided and operated by the railway undertaking and the station platform where it will be used;
- (d) the rolling stock where a boarding aid has to be provided by the railway undertaking and operated by the infrastructure manager or station manager, and the station platforms where it will be used;
- (e) for boarding aids located on the platforms, the location where they are most likely to be used, taking into account that a free space (no obstacles) of 150 cm is available from the edge of the boarding aid towards the direction where the wheelchair boards/lands at/to the platform level;

| | | | |
|---|--|--------------------|------------------|
|  OTIF | Uniform Technical Prescription | | UTP PRM |
| | Accessibility for persons with disabilities and persons with reduced mobility | | Page 47 of 86 |
| Status: PROPOSAL | | TECH-25004 Annex 2 | Original: EN |
| | | | Date: 24.02.2025 |

- (f) the conditions for the provision of alternative transport where:
- the platform cannot be reached through an obstacle-free route, or
 - assistance cannot be provided to deploy a boarding aid between the platform and the rolling stock.

4.5 Maintenance rules

4.5.1 Infrastructure Subsystem

The requirement in this clause relates to the operational performance of the infrastructure during maintenance. Compliance with this clause in non-EU Contracting States is recommended but not mandatory, as the application of this UTP to the infrastructure subsystem is not mandatory.

The infrastructure manager or station manager shall have procedures that include the provision of alternative assistance to disabled persons and persons with reduced mobility during maintenance, replacement or repair of facilities that are for use of persons with disabilities and persons with reduced mobility.

4.5.2 Rolling Stock Subsystem

If a facility that has been incorporated for persons with disabilities and persons with reduced mobility becomes defective (this includes tactile signs), the railway undertaking shall ensure that he has procedures for the facility to be repaired or replaced within 6 working days of the occurrence being reported.

4.6 Professional qualifications

The requirements in this clause apply to professional qualifications of staff of which the activities may affect the technical state of rolling stock and its use. Its application is mandatory in the context of rolling stock maintenance. Its application is recommended in the context of rolling stock operations.

The professional qualifications of staff required for the operation and maintenance of the

infrastructure or

rolling stock subsystems according to the technical scope as defined in point 1.1, and according to point 4.4 giving the list of operational rules, concerned by this UTP, are as follows:

Professional training of staff performing the tasks of accompanying trains, delivering service and help for passengers at a station and of selling

| | | | |
|---|--|--------------------|------------------|
|  OTIF | Uniform Technical Prescription | | UTP PRM |
| | Accessibility for persons with disabilities and persons with reduced mobility | | Page 48 of 86 |
| Status: PROPOSAL | | TECH-25004 Annex 2 | Original: EN |
| | | | Date: 24.02.2025 |

tickets shall include the subject of disability awareness and equality, including the specific needs of all persons with disabilities and persons with reduced mobility.

Professional training of engineers and managers, responsible for maintaining rolling stock, are recommended to

and operating the infrastructure or the rolling stock, shall

include the subject of disability awareness and equality, including the specific needs of all persons with disabilities and persons with reduced mobility.

4.7 Health and safety conditions

There is neither specific requirement in the scope of this UTP related to the health and safety conditions of staff required for the operation of the infrastructure or rolling stock subsystem nor for the implementation of the UTP.

5. INTEROPERABILITY CONSTITUENTS

5.1 Definition

Interoperability constituents (ICs) are defined in Article 2(g) of ATMF.

An IC shall comply with the technical specifications of this chapter whether it is assessed separately as an IC or is assessed as an integrated part of a subsystem.

The assessment of ICs separate from the subsystem shall be carried out according to the specification in sections 5.3 and 6.1 of this UTP.

If the IC is assessed as a part of the subsystem, the assessment procedures for subsystems apply. The applicable requirements are those set out in sections 5.3 and 6.1.

5.2 Innovative solutions

As stated in point 4.1 of this UTP, innovative solutions may require new specification and / or new assessment methods. These specifications and assessment methods shall be developed by the process described in

the UTP LOC&PAS.

article 6 of the Regulation ⁽⁶⁾.

⁶ The provisions are set out in Article 6 of the Regulation enacting the PRM TSI.

| | | | |
|---|--|--------------------|------------------|
|  OTIF | Uniform Technical Prescription | | UTP PRM |
| | Accessibility for persons with disabilities and persons with reduced mobility | | Page 49 of 86 |
| Status: PROPOSAL | | TECH-25004 Annex 2 | Original: EN |
| | | | Date: 24.02.2025 |

5.3 List and characteristics of constituents

The interoperability constituents are covered by the relevant provisions of APTU and ATMF | Directive (EU) 2016/797 and are listed below.

5.3.1 Infrastructure

The application of this UTP to infrastructure is not mandatory. Consequently, the application of this UTP is not mandatory for interoperability constituents for infrastructure.

The following items are identified as being interoperability constituents for Infrastructure:

5.3.1.1 (Reserved)

5.3.1.2 Platform ramps

- (1) Ramps shall be designed and assessed for an area of use defined by the maximum vertical gap they can overcome within a maximum slope of 18% (10.2°).
- (2) Ramps shall accommodate a wheelchair with characteristics as detailed in Appendix M.
- (3) Ramps shall withstand a weight of at least 300 kg, placed at the centre of the device distributed over an area of 660 mm by 660 mm.
- (4) If the ramp is power operated it shall incorporate a method of manual operation should power fail.
- (5) The ramp surface shall be slip resistant and shall have a stable position with an effective clear width of a minimum of 760 mm.
- (6) Ramps having a clear width of less than 1000 mm shall have raised edges on both sides to prevent mobility aid wheels from slipping off.
- (7) The upstands at both ends of the ramp shall be bevelled and shall not be higher than 20 mm. They shall have contrasting hazard warning bands.
- (8) The ramp shall be equipped with a mechanism to securely locate the ramp so that it is not subject to displacement when in use for boarding or alighting.
- (9) The ramp shall be provided with self-contrasting markings.

5.3.1.3 Platform lifts

- (1) Lifts shall be designed and assessed for an area of use defined by the maximum vertical gap they can overcome.
- (2) Lifts shall accommodate a wheelchair with characteristics as detailed in Appendix M.

| | | | |
|---|--|--------------------|------------------|
|  OTIF | Uniform Technical Prescription | | UTP PRM |
| | Accessibility for persons with disabilities and persons with reduced mobility | | Page 50 of 86 |
| Status: PROPOSAL | | TECH-25004 Annex 2 | Original: EN |
| | | | Date: 24.02.2025 |

- (3) Lifts shall withstand a weight of at least 300 kg, placed at the centre of the device distributed over an area of 660 mm by 660 mm.
- (4) The lift platform surface shall be slip resistant.
- (5) At surface level, the lift platform shall have a minimum clear width of 800 mm and a length of 1200 mm. According to Appendix M, an additional length of 50 mm shall be available for feet above a height of 100 mm above the lift platform, considering both inboard and outboard orientations of the wheelchair user
- (6) The bridging plate overriding the gap between the lift platform and the carriage floor shall have a stable position with a minimum width of 760 mm.
- (7) Where provided, each control for deploying, lowering to ground level, raising and stowing the lift shall require continuous manual pressure by the operator and shall not allow an improper lift sequencing when the lift platform is occupied.
- (8) The lift shall incorporate a method of deploying, lowering to ground level with a lift occupant, and raising and stowing the empty lift if the power to the lift fails.
- (9) No part of the lift platform shall move at a rate exceeding 150 mm/second during lowering and lifting an occupant, and shall not exceed 600 mm/second during deploying or stowing (except if the lift is manually deployed or stowed).
- (10) The maximum lift platform horizontal and vertical acceleration when occupied shall be 0.3g.
- (11) The lift platform shall be equipped with barriers to prevent any of the wheels of a wheelchair from rolling off the lift platform during its operation.
- (12) A movable barrier or inherent design feature shall prevent a wheelchair from rolling off the edge closest to the vehicle until the lift is in its fully raised position.
- (13) Each side of the lift platform which extends beyond the vehicle in its raised position shall have a barrier a minimum 25 mm high. Such barriers shall not interfere with manoeuvring into or out of the aisle.
- (14) The loading-edge barrier (outer barrier) which functions as a loading ramp when the lift is at ground level, shall be sufficient when raised or closed, or a supplementary system shall be provided, to prevent a power wheelchair from riding over or defeating it.
- (15) The lift shall permit both inboard and outboard orientation of the wheelchair user.
- (16) The lift shall be provided with self-contrasting markings.

5.3.2 Rolling stock

The following items are identified as being interoperability constituents for rolling stock:

| | | | |
|---|--|--------------------|------------------|
|  OTIF | Uniform Technical Prescription | | UTP PRM |
| | Accessibility for persons with disabilities and persons with reduced mobility | | Page 51 of 86 |
| Status: PROPOSAL | | TECH-25004 Annex 2 | Original: EN |
| | | | Date: 24.02.2025 |

5.3.2.1 Interface of the door control device

- (1) A door control device shall have visual indication, on or around it when enabled and shall be operable by the palm of the hand exerting a force not greater than 15 N.
- (2) It shall be identifiable by touch (for example: tactile markings); this identification shall indicate the functionality.

5.3.2.2 Standard and universal toilets: common parameters

- (1) The centre of any door handle, lock or door control device on the exterior or interior of the toilet compartment shall be located at a minimum of 800 mm and a maximum of 1100 mm above the toilet door threshold.
- (2) A visual and tactile (or audible) indication shall be given inside and outside the toilet to indicate when a door has been locked.
- (3) Any door control device and other equipment inside the toilet compartment (except for baby nappy change facilities and call for aid devices) shall be operable by exerting a force not exceeding 20 N.
- (4) Any control device, including flushing system, shall contrast with the background surface, and shall be identifiable by touch.
- (5) Clear, precise information for the operation of any control device shall be provided, making use of pictograms and shall be tactile.
- (6) The toilet seat and lid, and any handrails shall contrast with the background.
- (7) If both opened and closed door control devices are fitted one above the other, the top device shall always be the open control.
- (8) Automatic and semi-automatic doors shall incorporate devices that prevent passengers becoming trapped during operation of the doors.
- (9) The force required to open or close a manual door shall not exceed 60 N.

5.3.2.3 Standard toilet

- (1) A standard toilet is not designed to be accessible to a wheelchair user.
- (2) The minimum door useable width shall be 500 mm.
- (3) A fixed vertical and/or horizontal handrail according to point 4.2.2.9 shall be provided adjacent to the toilet seat and the wash basin.

5.3.2.4 Universal toilet

- (1) A universal toilet is a toilet designed to be used by all passengers including all persons with disabilities and persons with reduced mobility.

| | | | |
|---|--|--------------------|------------------|
|  OTIF | Uniform Technical Prescription | | UTP PRM |
| | Accessibility for persons with disabilities and persons with reduced mobility | | Page 52 of 86 |
| Status: PROPOSAL | | TECH-25004 Annex 2 | Original: EN |
| | | | Date: 24.02.2025 |

- (2) The area of use of a universal toilet is defined by the method used for its assessment (A or B according to point 6.1.3.1)
- (3) The toilet access door shall provide a minimum clear usable width of 800 mm. Where the door is automatic or semi-automatic, it shall be possible to open it partially in order to allow a wheelchair user's assistant to leave and re-enter the toilet module.
- (4) The exterior of the door shall be marked with a sign in accordance with Appendix N.
- (5) There shall be sufficient space inside the toilet compartment to enable a wheelchair as defined in Appendix M to be manoeuvred to a position allowing both a lateral and a diagonal transfer of the wheelchair occupant to the toilet seat.
- (6) There shall be a minimum clear space of 700 mm in front of the toilet seat that shall follow the seat profile.
- (7) A horizontal handrail that complies with the requirements of point 4.2.2.9 shall be provided at each side of the toilet seat extending at least to the leading edge of the toilet seat.
- (8) The handrail on the wheelchair accessible side shall be hinged in such a way so as to enable an unobstructed transfer for the wheelchair user to and from the toilet seat.
- (9) The surface of the toilet seat, when lowered, shall be at a height of 450 mm to 500 mm above the floor level.
- (10) All amenities shall be readily accessible to a wheelchair user.
- (11) The toilet cubicle shall be fitted with not less than two call for aid devices that shall, when operated, send a signal to a person who can take appropriate action; they need not initiate a communication.
- (12) The interface of the call for aid devices shall be as defined in point 5.3.2.6.
- (13) One call for aid device shall be placed not more than 450 mm above the floor, measured vertically from the surface of the floor to the centre of the control. It shall be positioned so that the control can be reached by a person lying on the floor.
- (14) The other call for aid device shall be not less than 800 mm and not more than 1100 mm above the floor, measured vertically to the centre of the control.
- (15) These two call for aid devices shall be located on different vertical surfaces of the cubicle so that they can be reached from a range of positions.
- (16) The control of the call for aid devices shall be distinct from any other control within the toilet, be coloured differently from other control devices and contrast with their background.
- (17) If a baby nappy changing table is provided, in the lowered position its usable surface shall be between 800 mm and 1000 mm above floor level.

| | | | |
|---|--|--------------------|------------------|
|  OTIF | Uniform Technical Prescription | | UTP PRM |
| | Accessibility for persons with disabilities and persons with reduced mobility | | Page 53 of 86 |
| Status: PROPOSAL | | TECH-25004 Annex 2 | Original: EN |
| | | | Date: 24.02.2025 |

5.3.2.5 Baby nappy changing table

- (1) The usable surface of the baby nappy changing table shall be a minimum of 500 mm wide and 700 mm long.
- (2) It shall be designed to prevent a baby from inadvertently sliding off, shall have no sharp edges and shall be able to take a minimum load of 80 kg.
- (3) It shall be possible to put it into the stowed position with only one hand, using a force not exceeding 25 N.

5.3.2.6 Interface of the call for aid device

A call for aid device shall:

- (1) Be indicated by a sign having a yellow background contrasting with a black symbol (in accordance with the specification referenced in appendix A, index [10]). The symbol shall represent a bell or a telephone. The sign can be on the button or bezel or on a separate pictogram,
- (2) Include tactile symbols,
- (3) Emit a visual and audible indication to the user that it has been operated,
- (4) Provide additional operating information if necessary,
- (5) Be operable by the palm of a person's hand and not require a force exceeding 30 N to operate.

5.3.2.7 (Reserved)

5.3.2.8 Boarding aids: movable steps and bridging plates

- (1) A movable step or bridging plate shall be designed and assessed for an area of use defined by the width of the doorway it can fit.
- (2) The mechanical strength of the device shall be according to the specification referenced in Appendix A, index [11].
- (3) A suitable mechanism shall be installed in order to ensure the stability of the device in the deployed and retracted position.
- (4) The device surface shall be slip resistant and shall have an effective clear width as large as the doorway width.
- (5) The device shall be equipped with obstacle detection according to the specification referenced in Appendix A, index [11].
- (6) The device shall incorporate a method of deploying and stowing if the power to the step fails.

| | | | |
|---|--|--------------------|------------------|
|  OTIF | Uniform Technical Prescription | | UTP PRM |
| | Accessibility for persons with disabilities and persons with reduced mobility | | Page 54 of 86 |
| Status: PROPOSAL | | TECH-25004 Annex 2 | Original: EN |
| | | | Date: 24.02.2025 |

5.3.2.9 Boarding aids: on-board ramps

- (1) Ramps shall be designed and assessed for an area of use defined by the maximum vertical gap they can overcome within a maximum slope of 18% (10.2°).
- (2) Ramps shall withstand a weight of at least 300 kg, placed at the centre of the ramp distributed over an area of 660 mm by 660 mm.
- (3) An access ramp shall be either positioned manually by staff or deployed semi-automatically by mechanical means, operated by staff or by the passenger.
- (4) If the ramp is power operated it shall incorporate a method of manual operation should power fail.
- (5) The ramp surface shall be slip resistant and shall have an effective clear width of a minimum of 760 mm.
- (6) Ramps having a clear width of less than 1000 mm shall have raised edges on both sides to prevent mobility aid wheels from slipping off.
- (7) The upstands at both ends of the ramp shall be bevelled and shall not be higher than 20 mm. They shall have contrasting hazard warning bands.
- (8) When in use for boarding or alighting, the ramp shall be secured in use so that it is not subject to displacement when loading or unloading.
- (9) A semi-automatic ramp shall be fitted with a device capable of stopping the movement of that step if its front edge comes into contact with anything or person whilst the plate is in movement.
- (10) The ramp shall be provided with self-contrasting markings.

5.3.2.10 Boarding aids: on-board lifts

- (1) Lifts shall be designed and assessed for an area of use defined by the maximum vertical gap they can overcome.
- (2) The lift platform surface shall be slip resistant. At surface level, the lift platform shall have a minimum clear width of 760 mm and a length of 1200 mm. According to Appendix M, an additional length of 50 mm shall be available for feet above a height of 100 mm above the lift platform, considering both inboard and outboard orientations of the wheelchair user.
- (3) The bridging plate overriding the gap between the lift platform and the carriage floor shall have a minimum width of 720 mm.
- (4) The lift shall withstand a weight of at least 300 kg, placed at the centre of the lift platform distributed over an area of 660 mm by 660 mm.
- (5) Where provided, each control for deploying, lowering to ground level, raising and stowing the lift shall require continuous manual pressure and shall not allow an improper lift sequencing when the lift platform is occupied.
- (6) The lift shall incorporate a method of deploying, lowering to ground level with a lift occupant, and raising and stowing the empty lift if the power to the lift fails.

| | | | |
|---|--|--------------------|------------------|
|  OTIF | Uniform Technical Prescription | | UTP PRM |
| | Accessibility for persons with disabilities and persons with reduced mobility | | Page 55 of 86 |
| Status: PROPOSAL | | TECH-25004 Annex 2 | Original: EN |
| | | | Date: 24.02.2025 |

- (7) No part of the lift platform shall move at a rate exceeding 150 mm/second during lowering and lifting an occupant, and shall not exceed 600 mm/second during deploying or stowing (except if the lift is manually deployed or stowed).
- (8) The maximum lift platform horizontal and vertical acceleration when occupied shall be 0.3 g.
- (9) The lift platform shall be equipped with barriers to prevent any of the wheels of a wheelchair from rolling off the lift platform during its operation.
- (10) A movable barrier or inherent design feature shall prevent a wheelchair from rolling off the edge closest to the vehicle until the lift is in its fully raised position.
- (11) Each side of the lift platform which extends beyond the vehicle in its raised position shall have a barrier a minimum 25 mm high. Such barriers shall not interfere with manoeuvring into or out of the aisle.
- (12) The loading-edge barrier (outer barrier) which functions as a loading ramp when the lift is at ground level, shall be sufficient when raised or closed, or a supplementary system shall be provided, to prevent a power wheelchair from riding over or defeating it.
- (13) The lift shall permit both inboard and outboard orientation of the wheelchair user.
- (14) The lift shall be provided with self-contrasting markings.

6. ASSESSMENT OF CONFORMITY AND/OR SUITABILITY FOR USE

Modules for the

assessment procedures for the verification of elements of construction are described in the UTP GEN-D.

procedures for assessment of conformity, suitability for use and EC verification are described in the Commission Decision 2010/713/EU⁷.

6.1 Interoperability constituents (IC)

6.1.1 Conformity assessment

In accordance with UTP GEN-D, the law applicable in the Contracting States may require that ICs be assessed separately from the subsystem.

An EC declaration of conformity or suitability for use, in accordance with Article 9(2) and Article 10(1) of Directive (EU) 2016/797, shall be drawn up by the manufacturer or his authorised representative established in the Union before placing an interoperability constituent on the market.

⁷ Commission Decision 2010/713/EU of 9 November 2010 on modules for the procedures for assessment of conformity, suitability for use and EC verification to be used in the technical specifications for interoperability adopted under Directive 2008/57/EC of the European Parliament and of the Council.

| | | | |
|---|--|--------------------|------------------|
|  OTIF | Uniform Technical Prescription | | UTP PRM |
| | Accessibility for persons with disabilities and persons with reduced mobility | | Page 56 of 86 |
| Status: PROPOSAL | | TECH-25004 Annex 2 | Original: EN |
| | | | Date: 24.02.2025 |

If an IC is assessed separately from the subsystem, the assessment of the assessment | The conformity assessment of an interoperability constituent shall be in accordance with the prescribed module(s) of that particular constituent specified in point 6.1.2 of this UTP.

6.1.2 Application of modules

Assessment procedures (modules) for the verification of elements of construction. | The modules for the EC certification of conformity of interoperability constituents

are listed in the table below:

Table 14: Assessment procedures (modules) for the verification of elements of construction.

Table 14: Modules for EC certification of conformity of interoperability constituents

| | | |
|------------|---|---------------------|
| Module CA | Internal production control | |
| Module CA1 | Internal production control plus product verification by individual examination | |
| Module CA2 | Internal production control plus product verification at random intervals | |
| Module CB | Type examination | EC-Type examination |
| Module CC | Conformity to type based on internal production control | |
| Module CD | Conformity to type based on quality management system of the production process | |
| Module CF | Conformity to type based on product verification | |
| Module CH | Conformity based on full quality management system | |
| Module CH1 | Conformity based on full quality management system plus design examination | |
| Module CV | Type validation by in service experience (Suitability for use) | |

In the case of separate IC assessment, the manufacturer | The manufacturer or his authorised representative established within the Union shall choose one of the modules or module combinations indicated in the following table for the constituent to be assessed:



| | | | |
|---|--|--------------------|------------------|
|  OTIF | Uniform Technical Prescription | | UTP PRM |
| | Accessibility for persons with disabilities and persons with reduced mobility | | Page 57 of 86 |
| Status: PROPOSAL | | TECH-25004 Annex 2 | Original: EN |
| | | | Date: 24.02.2025 |

Table 15: Combination of modules for assessment procedures (modules) for the verification of elements of construction. | EC certification of conformity of interoperability constituents

| Point of this UTP/Annex | Constituents to be assessed | Modules | | | | | | |
|------------------------------|-----------------------------------|---------|--------------------------|--------|--------|--------|------------------|-----|
| | | CA | CA1 or CA2* ⁸ | CB +CC | CB +CD | CB +CF | CH* ⁸ | CH1 |
| 5.3.1.2 and 5.3.1.3 | Platform ramps and platform lifts | | X | | X | X | X | X |
| 5.3.2.1 | Interface of door control device | X | | X | | | X | |
| 5.3.2.2, 5.3.2.3 and 5.3.2.4 | Toilet modules | | X | X | X | | X | X |
| 5.3.2.5 | Baby nappy changing table | X | | X | | | X | |
| 5.3.2.6 | Call for aid devices | X | | X | | | X | |
| 5.3.2.8 to 5.3.2.10 | Boarding devices | | X | | X | X | X | X |

(*) Modules CA1, CA2 or CH may be used only in the case of products manufactured in accordance with a design developed and already used to place products on the market before the application of relevant TSIs applicable to those products, provided that the manufacturer demonstrates to the notified body that design review and type examination were performed for previous applications under comparable conditions, and are in conformity with the requirements of this TSI; this demonstration shall be documented, and is considered as providing the same level of proof as module CB or design examination in accordance with module CH1.

⁸ Modules CA1, CA2 or CH may be used only in the case of products manufactured in accordance with a design developed and already used to place products on the market before the application of relevant UTPs applicable to those products, provided that the manufacturer demonstrates to the assessing entity that design review and type examination were performed for previous applications under comparable conditions, and are in conformity with the requirements of this UTP; this demonstration shall be documented, and is considered as providing the same level of proof as module CB or design examination in accordance with module CH1.

| | | | |
|---|--|--------------------|------------------|
|  OTIF | Uniform Technical Prescription | | UTP PRM |
| | Accessibility for persons with disabilities and persons with reduced mobility | | Page 58 of 86 |
| Status: PROPOSAL | | TECH-25004 Annex 2 | Original: EN |
| | | | Date: 24.02.2025 |

Where a particular procedure shall be used for the assessment, this is specified in the point 6.1.3.

6.1.3 Particular assessment procedures

6.1.3.1 Universal Toilet Module

The space inside the toilet compartment enabling a wheelchair as defined in Appendix M to be manoeuvred to a position allowing both a lateral and a diagonal transfer of the wheelchair occupant to the toilet seat shall be assessed using the method A described in the specification referenced in Appendix A, index [9].

Alternatively, where method A cannot be used, it is allowed to utilize method B described in the specification referenced in Appendix A, index [9]. This allowance is only provided for in the following cases:

- vehicles where the available floor width is narrower than 2400 mm,
- existing rolling stock when it is renewed or upgraded.

6.1.3.2 Toilet Module and Universal Toilet Module

When a toilet module or a universal toilet module is not built as an independent compartment, its characteristics can be assessed at subsystem level.

6.2 Subsystems

6.2.1 Verification of conformity ⁹

The OTIF procedure for granting technical certificates is set out in ATMF Article 10.

The EC verification procedures to be applied to the subsystems are described in Article 15 of Directive (EU) 2016/797 and Annex IV to that Directive.

The UTP verification procedure shall be performed in accordance with the prescribed modules(s) specified in point 6.2.2 of this UTP.

For the infrastructure subsystem, if the applicant demonstrates that tests or assessments of a subsystem or parts of a subsystem are the same or have been successful for previous applications of a design, the assessing entity shall consider the results of those tests and assessments for the verification.

For the infrastructure subsystem, the objective of inspection by an assessing entity is to ensure that the requirements of the UTP are fulfilled. The inspection is performed as a visual examination; in case of doubt, for the values verification, the assessing entity can ask the applicant to perform measurements. In case different methods are possible (e.g. for contrast), the measurement method shall be the one used by the applicant.

The approval process and the contents of the assessment shall be agreed between the applicant and assessing entity in accordance with the requirements set out in this UTP.

⁹ The title of point 6.2.1 of the TSI is “EC verification (general)”.

| | | | |
|---|--|--------------------|------------------|
|  OTIF | Uniform Technical Prescription | | UTP PRM |
| | Accessibility for persons with disabilities and persons with reduced mobility | | Page 59 of 86 |
| Status: PROPOSAL | | TECH-25004 Annex 2 | Original: EN |
| | | | Date: 24.02.2025 |

6.2.2 Assessment procedures for the verification of subsystems (modules)

The modules for the assessment procedures for the verification of subsystems are listed in the table below:

Table 16: Modules for the assessment procedures for the verification of subsystems

| | |
|-------------------------|--|
| Module SB | OTIF Type examination |
| Module SD | Quality management system of the production process |
| Module SF | Verification based on product verification |
| Module SG ¹⁰ | reserved |
| Module SH1 | Verification based on full quality management system plus design examination |

The applicant shall choose one of the modules or module combinations indicated in Table 17.

Table 17: Combination of Modules for the assessment procedures for the verification of subsystems

| Subsystem to be assessed | Modules | | | |
|--------------------------|---------|-------|----|-----|
| | SB+SD | SB+SF | SG | SH1 |
| Rolling Stock Subsystem | X | X | | X |
| Infrastructure Subsystem | | | X | X |

The characteristics of the subsystem to be assessed during the relevant phases are indicated in appendix E to this UTP, Table E.1 for Infrastructure subsystem and Table E.2 for rolling stock subsystem. The applicant shall confirm that

rolling stock subsystem (mandatory) and/or the infrastructure subsystem (voluntary) | each subsystem produced complies with the type.

¹⁰ Application of this UTP for the infrastructure subsystem is voluntary so there is no module SG in COTIF describing the assessment procedure for the verification of infrastructure subsystem.

| | | | |
|---|--|--------------------|------------------|
|  OTIF | Uniform Technical Prescription | | UTP PRM |
| | Accessibility for persons with disabilities and persons with reduced mobility | | Page 60 of 86 |
| Status: PROPOSAL | | TECH-25004 Annex 2 | Original: EN |
| | | | Date: 24.02.2025 |

6.2.3 Particular assessment procedures

6.2.3.1 Wheelchair transfer seat

The assessment of the requirement for the provision of transfer seats shall only consist in verifying that they are present and equipped with movable armrests. In particular the method of transfer shall not be assessed.

6.2.3.2 Step position for vehicle access and egress

This requirement shall be validated by calculation using the nominal values of the construction drawing of the vehicle and the nominal values of the relevant platform or platforms where the rolling stock is intended to stop. The outer end of the floor at the passenger access door shall be considered as a step.

6.2.3.3 Assessment of contrast for the rolling stock subsystem

Assessment of contrast for the rolling stock subsystem shall be performed in accordance with the specification referenced in Appendix A, Index [18].

6.2.4 Technical solutions giving presumption of conformity at design stage

With regard to this UTP, the infrastructure subsystem can be considered as an assembly made of a succession of recurring subcomponents such as:

- Parking facilities,
- Doors and entrances, transparent obstacles with their marking,
- Tactile walking surface indicators, tactile information along obstacle-free routes,
- Ramps and stairs with handrails,
- Mounting and highlighting of furniture,
- Ticketing or information counters,
- Ticket vending and control machines,
- Visual information: signposting, pictograms, dynamic information,
- Platforms, including ends and edges, shelters and waiting areas when provided,
- Level track crossings.

For those subcomponents of the infrastructure subsystem, presumption of conformity may be assessed at design stage prior to and independently from any specific project. An intermediate statement of verification (ISV) shall be issued by an Assessing entity at design stage.

6.2.5 Assessment of maintenance

The applicant for assessment

In accordance with Article 15(4) of Directive (EU) 2016/797, the applicant

shall be responsible for compiling the technical file, containing the documentation requested for operation and maintenance.

| | | | |
|---|--|--------------------|------------------|
|  OTIF | Uniform Technical Prescription | | UTP PRM |
| | Accessibility for persons with disabilities and persons with reduced mobility | | Page 61 of 86 |
| Status: PROPOSAL | | TECH-25004 Annex 2 | Original: EN |
| | | | Date: 24.02.2025 |

The Assessing Entity shall verify only that the documentation requested for operation and maintenance, as defined in point 4.5 of this UTP, is provided. The Assessing Entity is not required to verify the information contained in the documentation provided.

6.2.6 Assessment of operational rules

The railway undertaking is responsible for the safe operation of its trains (ATMF Article 6 § 2), i.e. it shall ensure that all safety-related on-train equipment is in a fully functional state and that the train is safe to run.

In conformity with Articles 10 and 12 of Directive (EU) 2016/798, railway undertakings and infrastructure managers must demonstrate compliance with the operational requirements of this TSI within their safety management system when applying for any new or amended safety certificate or safety authorisation.

6.2.7 Assessment of units intended to be used in general operation

When rolling stock is supplied as individual vehicles, rather than in fixed units, such vehicles shall be assessed against the relevant points of this UTP, accepting that not every such vehicle will have wheelchair spaces, wheelchair accessible facilities or a universal toilet.

The area of use in terms of type of rolling stock which, coupled with the unit to be assessed, ensures that the train is fully compliant with the UTP is not verified by the Assessing Entity.

After such a unit has received

an admission to operation in international traffic | the authorisation to be placed on the market,

it is the responsibility of the railway undertaking to make sure, when forming the train with other compatible vehicles, that point 4.2 of this UTP is complied with at train level.

in accordance with the rules defined in point 4.2.2.5 of the OPE TSI (train composition).

7. IMPLEMENTATION OF THE UTP

7.1 Application of this UTP to new infrastructure and rolling stock

7.1.1 New Infrastructure

The application of infrastructure related parameters of this UTP is optional.

This TSI is applicable to all new stations in its scope.

It is not mandatory to apply this TSI to new stations which have already been granted a building permit or which are subject to a contract for major construction works that is either already signed or in the final phase of tendering procedure at the date of application of this TSI.

However, an earlier version of this TSI must be applied within its defined scope. The consistence of applicable requirements of partial application of different versions of this TSI to

| | | | |
|---|--|--------------------|------------------|
|  OTIF | Uniform Technical Prescription | | UTP PRM |
| | Accessibility for persons with disabilities and persons with reduced mobility | | Page 62 of 86 |
| Status: PROPOSAL | | TECH-25004 Annex 2 | Original: EN |
| | | | Date: 24.02.2025 |

particular sections of the station must be justified by the applicant and certified by the notified body.

Where stations which were closed for a long time to passenger service are put in service again, this may be treated as renewal or upgrade in accordance with point 7.2.

In all cases of construction of a new station, the station manager or planning entity shall organise a consultation of the entities in charge of the management of the neighbourhood, in order to enable as far as possible the accessibility requirements to be met not only in the station, but also for the access to the station. In the case of multimodal stations, other transport authorities shall be consulted for access to and from the railway and to and from other modes of transport.

7.1.2 New Rolling Stock

- | | |
|---|---|
| <p>(1) This UTP is applicable to rolling stock in the scope of the UTP LOC&PAS.</p> | <p>This TSI is applicable to all units of rolling stock in its scope which are placed on the market after 28 September 2023, except where point 7.1.1.2 “Application to ongoing projects” of the LOC&PAS TSI applies.</p> |
| <p>(2) Compliance with earlier versions of the UTP PRM</p> | <p>Compliance with this Annex in its version applicable before 28 September 2023</p> |
- is deemed equivalent to compliance with this UTP, except for the changes listed in Appendix P.
- (3) The rules related to the type or design examination certificates for the rolling stock subsystem and the associated interoperability constituents shall be as specified in point 7.1.3 of the UTP LOC&PAS.

7.2 Application of this UTP to existing infrastructure and rolling stock

7.2.1 Steps of the gradual transition to the target system

This UTP applies to rolling stock units when they are renewed or upgraded.

| | |
|--|--|
| <p>This UTP is not mandatory for the infrastructure subsystem.</p> | <p>This TSI does not apply to renewed or upgraded stations which have already been granted a building permit or which are subject to a contract for construction works that is either already signed or under final phase of tendering procedure at the date of application of this UTP.</p> |
|--|--|

This UTP does not apply to renewed or upgraded rolling stock which are subject to a contract already signed or under final phase of tendering procedure at the date of application of this UTP.

| | |
|--|--|
| <p>For existing rolling stock, the overarching aim of the UTP is to achieve compliance with the UTP through the identification and progressive elimination of existing obstacles to accessibility.</p> | <p>For the existing infrastructure and</p> |
|--|--|

| | | | |
|---|--|--------------------|------------------|
|  OTIF | Uniform Technical Prescription | | UTP PRM |
| | Accessibility for persons with disabilities and persons with reduced mobility | | Page 63 of 86 |
| Status: PROPOSAL | | TECH-25004 Annex 2 | Original: EN |
| | | | Date: 24.02.2025 |

Member States ensure that inventories of assets are organized and adopt implementation plans in order to achieve the aim of this Regulation.

7.2.1.1 Inventory of assets – Infrastructure

The requirement in this clause and its sub-clauses 7.2.1.1.1 to 7.2.1.1.4, including Appendix O, relates to specifying the characteristics of the inventory of assets, including functional and technical architecture, rules for data input and consultations and rules for self-assessment and designation of the entities responsible for data provision.

Compliance with this clause in non-EU Contracting States is recommended but not mandatory, as the application of this UTP to the infrastructure subsystem is not mandatory.

7.2.1.1.1 Functional and technical architecture

The functions of the inventory of assets consist of:

- (1) identifying the existing obstacles and barriers to accessibility;
- (2) providing practical information to users;
- (3) monitoring and evaluating progress on accessibility.

There are no equivalent provisions in force in COTIF, so it is recommended that Contracting States which do not apply the EU regulation should implement equivalent national rules.

The architecture for the exchange of accessibility data is provided for in Regulation (EU) No 454/2011 (TAP TSI).

The specifications referenced in Appendix A, Indexes [21] and [22] shall apply to the formatting and exchange of accessibility data.

For the intended particular usage, a harmonised specific transmodel profile as is provided for in the technical documents referred to in Appendix O, index 1.

7.2.1.1.2 Rules for the input and self-assessment of accessibility data

(reserved)

The rules for the input and self-assessment of accessibility data shall be the following:

- (1) entities that collect the accessibility data relative to assets need not be independent from the daily management of those assets;
- (2) during the first collection of accessibility data pursuant to the entry into force of Commission Implementing Regulation

| | | | |
|---|--|--------------------|------------------|
|  OTIF | Uniform Technical Prescription | | UTP PRM |
| | Accessibility for persons with disabilities and persons with reduced mobility | | Page 64 of 86 |
| Status: PROPOSAL | | TECH-25004 Annex 2 | Original: EN |
| | | | Date: 24.02.2025 |

(EU) 2019/772¹¹, the state of conformity of stations to this TSI may be inventoried as unassessed;

- (3) where a station, or elements thereof, undergoes an upgrade, renewal work or any type of work foreseen by a national implementation plan for this TSI, the corresponding accessibility data shall be updated, including the state of conformity to this TSI, where relevant;
- (4) the state of conformity to this TSI may be updated on the basis of an ISV as described in point 6.2.4 of this TSI;
- (5) the working order of the equipment does not need to be inventoried.

A data collection tool, the operating modes of which are described in the technical documents referred to in Appendix O, index 2, shall be made available by the Commission.

Alternatively, where structured accessibility data exist and may be converted to the harmonised profile, those data may be transferred after conversion. The methodology for the conversion of existing accessibility data and the communication protocol are provided for in the technical documents referred to in Appendix O, index 3.

7.2.1.1.3 Rules for consultation

(reserved)

From the ERSAD¹²:

- (1) the public shall be able to access information from a public website hosted by the European Union Agency for Railways;
- (2) registered national authorities shall be able to retrieve all accessibility data that are relevant to the Member State;
- (3) the Commission and the Agency shall be able to retrieve all accessibility data.

¹¹ Commission Implementing Regulation (EU) 2019/772 of 16 May 2019 amending Commission Regulation (EU) No 1300/2014 as regards inventory of assets with a view to identifying barriers to accessibility, providing information to users and monitoring and evaluating progress on accessibility.

¹² European Railway Stations Accessibility Database (ERSAD)

| | | | |
|---|--|--------------------|------------------|
|  OTIF | Uniform Technical Prescription | | UTP PRM |
| | Accessibility for persons with disabilities and persons with reduced mobility | | Page 65 of 86 |
| Status: PROPOSAL | | TECH-25004 Annex 2 | Original: EN |
| | | | Date: 24.02.2025 |

7.2.1.1.4 *Rules for the management of user feedback*

(reserved)

Feedback from users may take the form of:

- (1) institutional feedback from users associations, including organisations representing persons with disabilities: existing structures may be used as long as they include representatives from organisations of persons with disabilities and persons with reduced mobility and reflect the situation at an appropriate level, not necessarily at a national level. The procedure for giving user feedback shall be organised so as to permit the participation of those organisations on an equal basis;
- (2) individual feedback: website visitors shall be provided with the possibility to report incorrect information about accessibility data regarding a particular station and get an acknowledgement that their comment has been received.

In both situations, the feedback from users shall be adequately considered by the entity(ies) responsible for collecting, maintaining and exchanging the data.

7.2.2 **Application of this UTP to existing Infrastructure**

For Infrastructure, the conformity with this UTP is optional.

TSI is mandatory for those parts that are renewed or upgraded. However, the UTP recognizes that, due to the characteristics of the inherited railway system, compliance of existing infrastructure may be achieved through a gradual improvement of accessibility.

In addition to this gradual approach, the target system for existing infrastructure permits the following exceptions:

- In case an obstacle free route is created from existing footbridges, stairways and subways, including doors, lifts and ticket control machines, compliance with requirements related to dimensions of those in respect of width is not mandatory.

| | | | |
|---|--|--------------------|------------------|
|  OTIF | Uniform Technical Prescription | | UTP PRM |
| | Accessibility for persons with disabilities and persons with reduced mobility | | Page 66 of 86 |
| Status: PROPOSAL | | TECH-25004 Annex 2 | Original: EN |
| | | | Date: 24.02.2025 |

- Compliance with requirements related to the minimum width of the platform is not mandatory for existing stations if the cause of non-compliance is the presence of certain platform obstacles (e.g. structural columns, stairwells, lifts etc.) or existing tracks that are unlikely to be moveable.
- Where an existing station, or a part of it, is a recognised historic building and is protected by National Law, it is allowed to adapt the requirements of this UTP in order not to infringe the National law for the protection of the building.

7.2.3 Application of this UTP to rolling stock in operation or to an existing rolling stock type

- (1) The rules for managing changes to rolling stock in operation or to an existing rolling stock type shall be as specified in point 7.1.2 of the UTP LOC&PAS and in Appendix F to this UTP.
- (2) If the applicant wishes to extend the area of use of a vehicle that has already been admitted to operation, it shall apply the rules as prescribed in point 7.1.4 of the UTP LOC&PAS.

The rules for the extension of the area of use for existing rolling stock in operation before 19 July 2010 or having an authorisation in accordance with Directive 2008/57/EC shall be as specified in point 7.1.4 of the LOC&PAS TSI.

7.3 Specific cases

7.3.1 General

The specific cases, as listed in the following points, describe special provisions that are needed and authorised on particular networks of each Contracting State.

The specific cases for Member States of the European Union are those which are included in the TSI PRM.

These specific cases are classified as:

- “P” cases: “permanent” cases.
- “T” cases: “temporary” cases, where it is planned that the target system is reached in the future.

| | | | |
|---|--|--------------------|------------------|
|  OTIF | Uniform Technical Prescription | | UTP PRM |
| | Accessibility for persons with disabilities and persons with reduced mobility | | Page 67 of 86 |
| Status: PROPOSAL | | TECH-25004 Annex 2 | Original: EN |
| | | | Date: 24.02.2025 |

7.3.2 List of specific cases

7.3.2.1 Clearways (point 4.2.2.6)

Specific case United Kingdom for Great Britain (“P”)

For reasons of restricted structure gauge, track curvature and consequent restricted vehicle width, it is permissible for clause 4.2.2.6 (1st bullet) to be complied with only for access to priority seats. This specific case does not prevent the access of TSI compliant rolling stock to the national network.

7.3.2.2 Step position for vehicle access and egress (point 4.2.2.11)

Specific case United Kingdom for Great Britain (“P”)

For all rolling stock intended to stop, in normal operation at platforms of nominal 915 mm height.

It is permissible for passenger access steps for the vehicle to be designed to meet either the following values when the vehicle is stationary at a GB nominal 915 mm high platform.

The values of δ_h , δ_{v+} and δ_{v-} according to the following table:

Table 25 Values of δ_h , δ_{v+} and δ_{v-} for specific case United Kingdom

| | δ_h mm | δ_{v+} mm | δ_{v-} mm |
|---|---------------|------------------|------------------|
| on a straight level track | 200 | 230 | 160 |
| on a track with a curve radius of 300 m | 290 | 230 | 160 |

Or, alternatively the position set out in the national technical rules notified for this purpose.

| | | | |
|---|--|--------------------|------------------|
|  OTIF | Uniform Technical Prescription | | UTP PRM |
| | Accessibility for persons with disabilities and persons with reduced mobility | | Page 68 of 86 |
| Status: PROPOSAL | | TECH-25004 Annex 2 | Original: EN |
| | | | Date: 24.02.2025 |

Appendix A: Standards or Normative Documents Referred to in this UTP

| Index | Characteristics to be assessed | UTP Point | Mandatory standard point |
|-------|---|---------------|---|
| [1] | EN 81-70:2021+A1:2022 Safety rules for the construction and installation of lifts – Particular applications for passenger and goods passenger lift – Part 70: Accessibility to lifts for persons including persons with disability | | |
| [1.1] | Dimensions of the lifts | 4.2.1.2.2 (5) | 5.3.1, Table 3 |
| [1.2] | Tactile signage | 4.2.1.10 (7) | Table 4 points (c), (h), (j) and (k) |
| [2] | EN 115-1:2017 Safety of escalators and moving walks – Part 1: Construction and installation | | |
| [2.1] | Design of escalators and moving walks | 4.2.1.2.2 (6) | 5.4.1.2.2, 5.4.1.2.3, 5.2.2 |
| [3] | EN 12464-2:2014 Light and lighting – Lighting of work places – Part 2: Outdoor work places | | |
| [3.1] | Lighting on platforms | 4.2.1.9 (3) | Table 5.12, except points 5.12.16 and 5.12.19 |
| [4] | EN 12464-1:2021 Light and lighting – Lighting of work places – Part 1: Indoor work places | | |
| [4.1] | Lighting on platforms | 4.2.1.9 (3) | 61.1.2 |
| [5] | EN 60268-16:2020 Sound system equipment – Part 16: Objective rating of speech intelligibility by speech transmission index | | |
| [5.1] | Speech transmission index, stations | 4.2.1.11 (1) | Annex B |
| [5.2] | Speech transmission index, rolling stock | 4.2.2.7.4 (5) | |
| [6] | EN 13272-1:2019 Railway applications – Electrical lighting for rolling stock in public transport systems – Part 1: Heavy rail | | |
| [6.1] | Lighting in rolling stock | 4.2.2.4 (1) | 4.1.2 |
| [6.2] | Reduction of lighting (operational rule) | 4.4.2.7 | 4.1.6, 4.1.7 |
| [7] | ISO 3864-1:2011 Graphical symbols – Safety colours and safety signs – Part 1: Design principles for safety signs and safety markings | | |
| [7.1] | Safety, warning, mandatory action and prohibition signs | 4.2.2.7.2 (1) | 6, 7, 8, 9, 10, 11 |
| [8] | EN 15273-1:2013+A1:2016/AC:2017 Railway applications – Gauges - Part 1: General – Common rules for infrastructure and rolling stock | | |

| | | | |
|---|--|--------------------|------------------|
|  OTIF | Uniform Technical Prescription | | UTP PRM |
| | Accessibility for persons with disabilities and persons with reduced mobility | | Page 69 of 86 |
| Status: PROPOSAL | | TECH-25004 Annex 2 | Original: EN |
| | | | Date: 24.02.2025 |

| Index | Characteristics to be assessed | UTP Point | Mandatory standard point |
|--------|--|------------------------------------|--------------------------|
| [8.1] | Calculation of bq_0 | 4.2.2.11.1 (2) | H.2.2 |
| [9] | EN 16585-1:2017 Railway applications – Design for PRM use – Equipment and components on board rolling stock – Part 1: Toilets | | |
| [9.1] | Assessment of the Universal Toilet Module | 6.1.3.1 | Chapter 6 |
| [9.2] | Comfortable reach range of a person using a wheelchair | 4.2.2.2 (12) | Figure B.2 |
| [10] | ISO 3864-4:2011 Graphical symbols – Safety colours and safety signs – Part 4: Colorimetric and photometric properties of safety sign materials | | |
| [10.1] | Definition of colours | 5.3.2.6 (1) | Chapter 4 |
| [11] | EN 14752:2019+A1:2021 Railway applications – Bodyside entrance systems for rolling stock | | |
| [11.1] | Boarding device mechanical strength | 5.3.2.8 (2) | 4.2.2 |
| [11.2] | Obstacle detection | 5.3.2.8 (5) | 5.4 |
| [12] | ISO 7000:2019 Graphical symbols for use on equipment – Registered symbols | | |
| [12.1] | Symbol for sign which identify wheelchair accessible areas | point N.3 of Appendix N | Symbol 0100 |
| [13] | ISO 7001:2007/Amd 4:2017 Graphical symbols – Public information symbols | | |
| [13.1] | Symbol for sign which identify wheelchair accessible areas | Point N.3 of Appendix N | Symbol PIPF 006 |
| [14] | ETSI EN 301 462:2000-03 Human Factors (HF); Symbols to identify telecommunications facilities for deaf and hard of hearing people | | |
| [14.1] | Symbol for sign indicating inductive loops | Point N.3 of Appendix N | 4.3.1.2 |
| [15] | EN 15273-2:2013+A1:2016 Railway applications – Gauges – Part 2: Rolling stock gauge | | |
| [15.1] | Specific case for Finland | 7.3.2.6 | Annex F |
| [16] | EN 16585-2:2017 Railway applications – Design for PRM use – Equipment and components on board rolling stock – Part 2: Elements for sitting, standing and moving | | |
| [16.1] | Diagrams of priority seats | 4.2.2.1.2.1 (7) 4.2.2.1.2.1 (8) | Annex A |
| [16.2] | Unidirectional seats | 4.2.2.1.2.2 (1) | Figure A.2 |

| | | | |
|---|--|--------------------|------------------|
|  OTIF | Uniform Technical Prescription | | UTP PRM |
| | Accessibility for persons with disabilities and persons with reduced mobility | | Page 70 of 86 |
| Status: PROPOSAL | | TECH-25004 Annex 2 | Original: EN |
| | | | Date: 24.02.2025 |

| Index | Characteristics to be assessed | UTP Point | Mandatory standard point |
|--------|---|------------------------------------|--------------------------|
| [16.3] | Facing seats arrangement | 4.2.2.1.2.3 (1) 4.2.2.1.2.3 (2) | Figures A.3 and A.4 |
| [16.4] | Diagrams of wheelchair spaces | 4.2.2.2 (4) | Figures B1, B2, B3 |
| [16.5] | Diagrams of wheelchair spaces | Appendix F | Figure 5 |
| [17] | EN 16585-3:2017 Railway applications – Design for PRM use – Equipment and components on board rolling stock – Part 3: Clearways and internal doors | | |
| [17.1] | Clearway through the vehicles | 4.2.2.6 (1) | Figure 2 |
| [17.2] | Clearway between connecting vehicles of a single trainset | 4.2.2.6 (1) | Figure 3 |
| [17.3] | Clearway to and from wheelchair accessible areas | 4.2.2.6 (1) | Figure 5 |
| [17.4] | Corridor widths for a change of direction | 4.2.2.6 (4) | Table 3 |
| [18] | EN 16584-1:2017 Railway applications – Design for PRM use – General requirements – Part 1: Contrast | | |
| [18.1] | Assessment of contrast for the rolling stock subsystem | 6.2.3.3 | Annex A, point A.1 |
| [19] | EN 16584-2:2017 Railway applications – Design for PRM use – General requirements – Part 2: Information | | |
| [19.1] | Door visible signals | 4.2.2.3.2 (11) | 5.3.3.2 (g) and (h) |
| [20] | EN 17285:2020 Railway applications – Acoustics – Measuring of door audible warnings | | |
| [20.1] | Measurement of interior door signals | App. G - G.4 | 5, 6, 7 |
| [20.2] | Measurement of exterior door signals | App. G - G.4 | 5, 6, 7 |
| [20.3] | Measurement of door finding signals | App. G - G.4 | 5, 7 |
| [21] | CEN/TS 16614-1:2020 Public transport – Network and Timetable Exchange (NeTEx) – Part 1: Public transport network topology exchange format | | |
| [21.1] | Formatting and exchange of accessibility data | 7.2.1.1.1 | All |
| [22] | EN 12896-1:2016 Public transport. Reference data model. Common concepts (Transmodel) | | |
| [22.1] | Formatting and exchange of accessibility data | 7.2.1.1.1 | All |

| | | | |
|---|--|--------------------|------------------|
|  OTIF | Uniform Technical Prescription | | UTP PRM |
| | Accessibility for persons with disabilities and persons with reduced mobility | | Page 71 of 86 |
| Status: PROPOSAL | | TECH-25004 Annex 2 | Original: EN |
| | | | Date: 24.02.2025 |

Appendix B: Temporary prioritization rule for the upgrade / renewal of stations

(reserved)

When renewed or upgraded, existing stations that have a daily passenger flow of 1000 passengers or less, combined embarking and disembarking, averaged over a 12 month period are not required to have lifts or ramps where these would otherwise be necessary to provide a step free route if another station within 50 km on the same route provides a fully compliant obstacle-free route. In such circumstances the design of stations shall incorporate provision for the future installation of a lift and/or ramps to make the station accessible to all persons with disabilities and persons with reduced mobility. National Rules shall be applied for organising the transport of persons with disabilities and persons with reduced mobility by an accessible means between this non accessible station and the next accessible station on the same route.

| | | | |
|---|--|--------------------|------------------|
|  OTIF | Uniform Technical Prescription | | UTP PRM |
| | Accessibility for persons with disabilities and persons with reduced mobility | | Page 72 of 86 |
| Status: PROPOSAL | | TECH-25004 Annex 2 | Original: EN |
| | | | Date: 24.02.2025 |

Appendix C:

Not used

Appendix D: Assessment of interoperability constituents

D.1 SCOPE

This Appendix indicates the assessment of conformity and suitability for use for interoperability constituents.

D.2 CHARACTERISTICS

The characteristics of the interoperability constituents to be assessed in the different phases of design, development and production are marked by X in Table D.1.

Table D.1 – Assessment of Interoperability Constituents.

| 1 | 2 | 3 | 4 | 5 |
|---|---|--|------------------|---|
| Interoperability Constituents and characteristics to be assessed | Assessment in the following phase | | | |
| | Design and development phase | | | Production phase |
| | Design review and /or Design examination | Review of manufacturing process | Type test | Verification of conformity to type |
| 5.3.1.2 Platform ramps | X | | X | X |
| 5.3.1.3 Platform lifts | X | | X | X |
| 5.3.2.1 Interface of the door control device | X | | X | X |
| 5.3.2.2 & 5.3.2.3 Standard toilets | X | | X | X |
| 5.3.2.2 & 5.3.2.4 Universal toilets | X | | X | X |
| 5.3.2.5 Baby nappy changing unit | X | | X | X |
| 5.3.2.6 Call for aid device | X | | X | X |
| 5.3.2.8 Movable step and bridging plate | X | | X | X |
| 5.3.2.9 On-board ramp | X | | X | X |

| | | | |
|---|--|--------------------|------------------|
|  OTIF | Uniform Technical Prescription | | UTP PRM |
| | Accessibility for persons with disabilities and persons with reduced mobility | | Page 73 of 86 |
| Status: PROPOSAL | | TECH-25004 Annex 2 | Original: EN |
| | | | Date: 24.02.2025 |

| 1 | 2 | 3 | 4 | 5 |
|---|---|--|------------------|---|
| Interoperability Constituents and characteristics to be assessed | Assessment in the following phase | | | |
| | Design and development phase | | | Production phase |
| | Design review and /or Design examination | Review of manufacturing process | Type test | Verification of conformity to type |
| 5.3.2.10 On-board lift | X | | X | X |

Appendix E: Assessment of the subsystems

E.1 SCOPE

This Appendix indicates the assessment of conformity of the subsystems.

E.2 CHARACTERISTICS AND MODULES

The sub-system characteristics to be assessed in the different phases of design, development and production are marked by X in Table E.1 for Infrastructure subsystem and Table E.2 for rolling stock subsystem.

Table E.1 – Assessment of the Infrastructure subsystem (constructed and supplied as single entity)

| 1 | 2 | 3 |
|--|--|---------------------------|
| Characteristics to be assessed | Design and development phase | Construction phase |
| | Design review and/or design examination | Inspection |
| Parking facilities for persons with disabilities and persons with reduced mobility | X | X |
| Obstacle-free routes | X | X |
| Route identification | X | X |
| Doors and entrances | X | X |
| Floor surfaces | X | X |
| Transparent obstacles | X | X |
| Toilets | X | X |
| Furniture and free-standing devices | X | X |

| | | | |
|---|--|--------------------|------------------|
|  OTIF | Uniform Technical Prescription | | UTP PRM |
| | Accessibility for persons with disabilities and persons with reduced mobility | | Page 74 of 86 |
| Status: PROPOSAL | | TECH-25004 Annex 2 | Original: EN |
| | | | Date: 24.02.2025 |

| 1 | 2 | 3 |
|---|---|--------------------|
| Characteristics to be assessed | Design and development phase | Construction phase |
| | Design review and/or design examination | Inspection |
| Ticketing / Counter or vending machine / Information counter / Ticket control machine / Turnstiles / Customer Assistance points | X | X |
| Lighting | X | X |
| Visual information: signposting, pictograms, dynamic information | X | X |
| Spoken information | X | X |
| Platform width and edge of platform | X | X |
| End of platform | X | X |
| Level track crossing at stations | X | X |

Table E.2 – Assessment of the rolling stock subsystem (constructed and supplied as serial products)

| 1 | 2 | 3 | 4 |
|--------------------------------|---|-----------|------------------|
| Characteristics to be assessed | Design and development phase | | Production phase |
| | Design review and/or design examination | Type Test | Routine Test |
| Seats | | | |
| General | X | X | |
| Priority Seats General | X | | |
| Uni-directional seats | X | X | |
| Facing seats arrangement | X | X | |
| Wheelchair spaces | X | X | |
| Doors | | | |
| General | X | X | |
| Exterior doors | X | X | |
| Interior doors | X | X | |
| Lighting | | X | |

| | | | |
|---|--|--------------------|------------------|
|  OTIF | Uniform Technical Prescription | | UTP PRM |
| | Accessibility for persons with disabilities and persons with reduced mobility | | Page 75 of 86 |
| Status: PROPOSAL | | TECH-25004 Annex 2 | Original: EN |
| | | | Date: 24.02.2025 |

| 1 | 2 | 3 | 4 |
|--|---|-----------|------------------|
| Characteristics to be assessed | Design and development phase | | Production phase |
| | Design review and/or design examination | Type Test | Routine Test |
| Toilets | X | | |
| Clearways | X | | |
| Customer Information | | | |
| General | X | X | |
| Signage, pictogram and tactile information | X | X | |
| Dynamic visual information | X | X | |
| Dynamic Audible information | X | X | |
| Height changes | X | | |
| Handrails | X | X | |
| Wheelchair Accessible sleeping accommodation | X | X | |
| Step position for vehicle access and egress | | | |
| General requirements | X | | |
| Access/egress steps | X | | X |
| Boarding aids | X | X | X |

Appendix F: Renewal or upgrade of rolling stock

Where parts of rolling stock are renewed or upgraded, they shall comply with the requirements of this UTP; compliance with the content of this UTP is not mandatory in the following cases:

Structures

Compliance is not mandatory if the work would require structural alterations to door portals (interior or external), underframes, collision pillars, vehicle bodies, vehicle over-ride protection, or more generally if the work would necessitate re-validation of the vehicle structural integrity.

Seats

Compliance with point 4.2.2.1 with regard to seat back grab handles is only mandatory if the seat structures are renewed or upgraded within an entire vehicle.

Compliance with point 4.2.2.1.2 with regard to the dimensions of priority seats and their surroundings is only mandatory if the seating layout is altered within an entire train and this can be achieved without

| | | | |
|---|--|--------------------|------------------|
|  OTIF | Uniform Technical Prescription | | UTP PRM |
| | Accessibility for persons with disabilities and persons with reduced mobility | | Page 76 of 86 |
| Status: PROPOSAL | | TECH-25004 Annex 2 | Original: EN |
| | | | Date: 24.02.2025 |

reducing the existing capacity of the train. In this case, the maximum number of priority seats shall be provided.

Compliance with requirements regarding headroom above priority seating is not mandatory if the limiting factor is a luggage rack that is not being structurally altered during the renewal or upgrading work.

Wheelchair spaces

The provision of wheelchair spaces is only required when the seating layout is altered within a complete train formation. However, if the entrance doorway, or clearways, cannot be modified to enable wheelchair access, a wheelchair space does not need to be provided if the seating layout is altered. Wheelchair spaces created in an existing rolling stock may be arranged in accordance with the specification referenced in Appendix A, Index [16].

The provision of call for aid devices at the wheelchair positions is not mandatory if the vehicle does not have an electrical communications system that can be adapted to include such a device.

The provision of a transfer seat is only mandatory when it does not require modifying the layout of an existing wheelchair space.

Exterior doors

Compliance with requirements to define the interior position of external doorways by contrast at floor level is only mandatory when the floor covering is renewed or upgraded.

Compliance with requirements to provide door opening and closing signals is only mandatory when the door control system is renewed or upgraded.

Full compliance with requirements regarding the position and illumination of door controls is only mandatory when the door control system is renewed or upgraded and when the controls can be re-positioned without alteration to the vehicle structure or door. However, in such an event, the renewed or upgraded controls shall be installed as close as possible to the compliant position.

Interior doors

Compliance with the requirements for door control operation operating forces and positioning is only mandatory if the door and door mechanism and/or control is being upgraded or renewed.

Lighting

Compliance with the requirement is not required if it can be established that there is insufficient capacity in the electrical system to support additional load, or that such lighting cannot locally be accommodated without structural alterations (doorways, etc.).

Toilets

Provision of a fully compliant universal toilet is only mandatory when existing toilets are being completely renewed or upgraded and a wheelchair space is provided, and a compliant universal toilet can be accommodated without structural alteration to the vehicle body.

The provision of call for aid devices in the universal toilet is not mandatory if the vehicle does not have an electrical communications system that can be adapted to include such a device.

Clearways

| | | | |
|---|--|--------------------|------------------|
|  OTIF | Uniform Technical Prescription | | UTP PRM |
| | Accessibility for persons with disabilities and persons with reduced mobility | | Page 77 of 86 |
| Status: PROPOSAL | | TECH-25004 Annex 2 | Original: EN |
| | | | Date: 24.02.2025 |

Compliance with the requirements of point 4.2.2.6 is only mandatory if the seating layout is altered within an entire vehicle and a wheelchair space is being provided.

Compliance with the requirements for clearways between connecting vehicles is only mandatory if the gangway is being renewed or upgraded.

Information

Compliance with the requirements of point 4.2.2.7 in respect of route information is not mandatory at renewal or upgrade. However, where an automated route information system is installed as part of a renewal or upgrade programme, it shall comply with the requirements of this point.

Compliance with the other parts of point 4.2.2.7 shall be mandatory whenever signage or interior finishes are renewed or upgraded.

Height Changes

Compliance with the requirements of point 4.2.2.8 is not mandatory at renewal or upgrade. However, a contrasting warning band on step nosings shall be provided when tread surface materials are renewed or upgraded.

Handrails

Compliance with the requirements of point 4.2.2.9 is only mandatory where existing handrails are being renewed or upgraded.

Wheelchair accessible sleeping accommodation

Compliance with the requirement to provide wheelchair accessible sleeping accommodation is only mandatory when existing sleeping accommodation is being renewed or upgraded.

The provision of call for aid devices in the wheelchair accessible sleeping accommodation is not mandatory if the vehicle does not have an electrical communications system that can be adapted to include such a device.

Step positions, steps and boarding aids

Compliance with the requirements of points 4.2.2.11 and 4.2.2.12 is not mandatory at renewal or upgrade. However, if moveable steps or other integral boarding aids are fitted, they shall comply with the relevant provisions of those points.

However, if a wheelchair space in accordance with point 4.2.2.3 is created at renewal or upgrade, then it shall be mandatory to provide some form of boarding aid in accordance with point 4.4.3.

| | | | |
|---|--|--------------------|------------------|
|  OTIF | Uniform Technical Prescription | | UTP PRM |
| | Accessibility for persons with disabilities and persons with reduced mobility | | Page 78 of 86 |
| Status: PROPOSAL | | TECH-25004 Annex 2 | Original: EN |
| | | | Date: 24.02.2025 |

Appendix G: Passenger external doors audible signals

G.1 DEFINITIONS

The following terms are used in this Appendix:

f_{signal} = frequency of excitation tone

L_S = sound pressure level measured as L_{AFmax} the maximum Sound Level with “A” Frequency weighting and Fast Time weighting during the measurement period.

L_{Smax} = maximum L_{AFmax}

L_{Smin} = minimum L_{AFmax}

L_N = surrounding noise level measured as follows:

- a) frequency range energetic sum of three octave bands

$$L_N = \sum \left(10^{\frac{L_1}{10}} + 10^{\frac{L_2}{10}} + 10^{\frac{L_3}{10}} \right)$$

where:

$L_1 = L_{oct.500 \text{ Hz}}$

$L_2 = L_{oct.1000 \text{ Hz}}$

$L_3 = L_{oct.2000 \text{ Hz}}$

- b) Sound Pressure level measured as an energy equivalent level of 20 s (L_{Aeq20})

G.2 DOOR OPENING AND CLOSING SIGNALS

G.2.1 Door opening signal

| | |
|----------------------|--|
| Characteristics | A slow multitone pulse (up to 2 pulses per second) of 2 tones emitted sequentially |
| Frequencies | $f_{signal1} = 2200 \text{ Hz} \pm 100 \text{ Hz}$ $f_{signal2} = 1760 \text{ Hz} \pm 100 \text{ Hz}$ |
| Sound pressure level | Adaptive device <ul style="list-style-type: none"> - $L_S \geq L_N + 5 \text{ dB}$ - $L_{Smax} = 70 \text{ dB} (+ 6 / - 0 \text{ dB})$ Non-adaptive device <ul style="list-style-type: none"> - $L_S = 70 \text{ dB} (+ 6 / - 0 \text{ dB})$ |

G.2.2 Door closing signal

| | |
|----------------------|--|
| Characteristics | A fast pulsed tone (6-10 pulses per second) |
| Frequency | $f_{signal} = 1900 \text{ Hz} \pm 100 \text{ Hz}$ |
| Sound pressure level | Adaptive device <ul style="list-style-type: none"> - $L_S \geq L_N + 5 \text{ dB}$ - $L_{Smax} = 70 \text{ dB} (+ 6 / - 0 \text{ dB})$ Non-adaptive device <ul style="list-style-type: none"> - $L_S = 70 \text{ dB} (+ 6 / - 0 \text{ dB})$ |

| | | | |
|---|--|--------------------|------------------|
|  OTIF | Uniform Technical Prescription | | UTP PRM |
| | Accessibility for persons with disabilities and persons with reduced mobility | | Page 79 of 86 |
| Status: PROPOSAL | | TECH-25004 Annex 2 | Original: EN |
| | | | Date: 24.02.2025 |

G.3 DOOR FINDING SIGNAL

The door finding signal can be a single tone signal (in accordance with point G.3.1) or a dual tone signal (in accordance with point G.3.2). Both signal types shall be equally accepted in all Contracting States.

G.3.1 Single Tone Signal

| | |
|----------------------|---|
| Characteristics | Interval of tone (rectangle), no fade in and fade out <ul style="list-style-type: none"> - signal impulse duration = 5 ms ± 1 ms “on” (pure tone impulse) - signal time pattern of 3 to 5 pulses per second |
| Frequency | $f_{\text{signal}} = 630 \text{ Hz} \pm 50 \text{ Hz}$ |
| Sound pressure level | Adaptive device <ul style="list-style-type: none"> - $L_S \geq L_N + 5 \text{ dB}$ - $L_{S\text{min}} = 45 \text{ dB} (\pm 2 \text{ dB})$ - $L_{S\text{max}} = 65 \text{ dB} (\pm 2 \text{ dB})$ Non-adaptive device <ul style="list-style-type: none"> - $L_S = 60 \text{ dB}$ |

G.3.2 Dual Tone Signal

| | |
|----------------------|---|
| Characteristics | Interval of tones (signal definition) <ul style="list-style-type: none"> - 100 ms sound pressure level fade in - 100 ms sound first tone 550 Hz ± 50 Hz - 100 ms sound pressure level fade out - 200 ms off - 100 ms sound pressure level fade in - 100 ms sound second tone 750 Hz ± 50 Hz - 100 ms sound pressure level fade out - 900 ms off - signal repetition time = 1700 ms |
| Frequencies | $f_{\text{signal1}} = 550 \text{ Hz} \pm 50 \text{ Hz}$ $f_{\text{signal2}} = 750 \text{ Hz} \pm 50 \text{ Hz}$ |
| Sound pressure level | Adaptive device <ul style="list-style-type: none"> - $L_S \geq L_N + 5 \text{ dB}$ - $L_{S\text{min}} = 50 \text{ dB} (\pm 2 \text{ dB})$ - $L_{S\text{max}} = 70 \text{ dB} (\pm 2 \text{ dB})$ Non-adaptive device <ul style="list-style-type: none"> - $L_S = 70 \text{ dB}$ |

G.4 MEASURING POSITIONS

The microphone position for the measurements of audible door signals shall be in accordance with the specification referenced in Appendix A, Index [20]. The specification shall also be used for the microphone position of the door finding signal despite the scope of the specification excluding the door finding signal.

Measurements to demonstrate compliance shall be carried out at three door locations on a train. The door shall be fully open for the close test and fully closed for the open test.

| | | | | |
|---|--|--------------------------|--------------|------------------|
|  OTIF | Uniform Technical Prescription Accessibility for persons with disabilities and persons with reduced mobility | UTP PRM Page 80 of 86 | | |
| Status: PROPOSAL | | TECH-25004 Annex 2 | Original: EN | Date: 24.02.2025 |

Appendix H:

Not used

Appendix I:

Not used

Appendix J:

Not used

Appendix K:

Not used

Appendix L:

Not used

| | | | |
|---|--|--------------------|------------------|
|  OTIF | Uniform Technical Prescription | | UTP PRM |
| | Accessibility for persons with disabilities and persons with reduced mobility | | Page 81 of 86 |
| Status: PROPOSAL | | TECH-25004 Annex 2 | Original: EN |
| | | | Date: 24.02.2025 |

Appendix M: Interoperable wheelchair transportable by train

M.1 SCOPE

This appendix identifies the maximum engineering limits for an interoperable wheelchair transportable by train. These limits are used for designing and assessing the rolling stock (architecture, structure, layout) and its components (access doors, internal doors, seats, toilets etc.). When the characteristics of a wheelchair exceed these limits, the conditions of use of the rolling stock might be degraded for the user (for instance no access to the wheelchair areas). Exceeding some limits may prevent the user from accessing the rolling stock.

These limits are defined by each railway undertaking, as specified in the point 4.2.6.1 of the Annex to Regulation (EU) No 454/2011.

M.2 CHARACTERISTICS

The values considered as engineering limits are:

Basic Dimensions

- Width of 700 mm plus 50 mm min each side for hands when moving.
- Length of 1200 mm plus 50 mm for feet.

Wheels

The smallest wheel shall accommodate a gap of dimensions 75 mm horizontal and 50 mm vertical.

Height

1450 mm max including a 95th percentile male occupant.

Turning circle

1500 mm

Weight

- Fully laden weight of 300 kg for wheelchair and occupant (including any baggage) in the case of an electrical wheelchair for which no assistance is required for crossing a boarding aid.
- Fully laden weight of 200 kg for wheelchair and occupant (including any baggage) in the case of a manual wheelchair.

Obstacle height that can be overcome and ground clearance

- Obstacle height that can be overcome 50 mm (max).
- Ground clearance 60 mm (min) with a upward slope angle of 10° (17%) on top for going forward (under the foot rest).

Maximum safe slope on which the wheelchair will remain stable:

- Shall have dynamic stability in all directions at an angle of 6° (10%).
- Shall have static stability in all directions (including with brake applied) at an angle of 9° (16%).

| | | | |
|---|--|--------------------|------------------|
|  OTIF | Uniform Technical Prescription | | UTP PRM |
| | Accessibility for persons with disabilities and persons with reduced mobility | | Page 82 of 86 |
| Status: PROPOSAL | | TECH-25004 Annex 2 | Original: EN |
| | | | Date: 24.02.2025 |

Appendix N: PRM Signage

N.1 SCOPE

This appendix identifies specific signage for use on both infrastructure and rolling stock.

N.2 DIMENSIONS OF SIGNS

Infrastructure PRM signage dimensions shall be calculated according to the formula:

Reading distance in mm divided by 250, multiplied by 1.25 = frame size in mm, where a frame is utilised.

The minimum tile size of rolling stock interior PRM signs shall be 60 mm with the exception of signs indicating utilities in the toilets or in the nursery that can be smaller.

The minimum tile size of rolling stock exterior PRM signs shall be 85 mm.

N.3 SYMBOLS TO USE ON SIGNS

International wheelchair sign

The sign which identifies wheelchair accessible areas shall include a symbol in accordance with one of the specifications referenced in Appendix A, index [12] or Index [13].

Inductive loop sign

The sign indicating where inductive loops are fitted shall include a symbol in accordance with the specification referenced in Appendix A, index [14].

Priority seating sign

The sign indicating where there are priority seats shall include symbols in accordance with figure N1.



| | | | |
|---|--|--------------------|------------------|
|  OTIF | Uniform Technical Prescription | | UTP PRM |
| | Accessibility for persons with disabilities and persons with reduced mobility | | Page 83 of 86 |
| Status: PROPOSAL | | TECH-25004 Annex 2 | Original: EN |
| | | | Date: 24.02.2025 |

Figure N1 – Symbols for priority seats



N.4 COLOUR OF SIGNS

The specific signage referred to in this Appendix shall be white on a dark blue background. Where signs are placed on a dark blue panel, it is allowed to invert the colours of the symbol and the background (i.e. dark blue symbol on a white background).

| | | | |
|---|--|--------------------|----------------------------------|
|  OTIF | Uniform Technical Prescription Accessibility for persons with disabilities and persons with reduced mobility | | UTP PRM Page 84 of 86 |
| Status: PROPOSAL | | TECH-25004 Annex 2 | Original: EN Date: 24.02.2025 |

Appendix O: List of technical documents

Not used

| | | | |
|---|--|--------------------|------------------|
|  OTIF | Uniform Technical Prescription | | UTP PRM |
| | Accessibility for persons with disabilities and persons with reduced mobility | | Page 85 of 86 |
| Status: PROPOSAL | | TECH-25004 Annex 2 | Original: EN |
| | | | Date: 24.02.2025 |

Appendix P: Changes of requirements and transition regimes

With the exception of the points listed in Table P.1 and Table P.2, compliance with the UTP PRM 2022 is deemed as compliance with this UTP.

For other TSI points than these listed in Table P.1 and Table P.2, compliance with the ‘previous TSI’ (i.e. this Regulation, as amended by Implementing Regulation (EU) 2019/772¹³) imply compliance with this TSI applicable from 28 September 2023.

Changes with a generic transition regime of 7 years:

With regard to the points listed in Table P.1, compliance with the UTP PRM 2022 (or any previous version) does not constitute compliance with this UTP.

For TSI points listed in Table P.1, compliance with the previous TSI does not imply compliance with the version of this TSI applicable from 28 September 2023.

Projects that were already in their design phase on 28 September 2023 shall comply with the requirements of this UTP from 28 September 2030.

Projects already in design phase on 28 September 2023 shall comply with the requirement of this TSI from 28 September 2030.

Projects in production phase and units in operation are not affected by the UTP requirements listed in Table P.1.

Projects in production phase and rolling stock in operation are not affected by the TSI requirements listed in Table P.1

Table P.1 – transition regime of 7 years

| UTP point(s) | UTP point(s) in previous UTP | Explanation of the UTP change |
|--|------------------------------|---|
| 4.2.2.1.1 (1a) | No requirement | New requirement specifying the correct position of the handle |
| 4.2.2.2 (8) | 4.2.2.2 (8) | More precise wording of the requirement |
| 4.2.2.3.2 (8) When a door is closed locally (by a passenger or crew), a door closing signal shall be given; it shall start following the operation of the control device and shall continue until the door is closed. | No requirement | New requirement |
| 4.2.2.3.2 (11) | No requirement | New requirement |
| 4.2.2.11.1 (3) | No requirement | New requirement |

¹³ Commission Implementing Regulation (EU) 2019/772 of 16 May 2019 amending Regulation (EU) No 1300/2014 as regards inventory of assets with a view to identifying barriers to accessibility, providing information to users and monitoring and evaluating progress on accessibility.

| | | | |
|---|--|--------------------|------------------|
|  OTIF | Uniform Technical Prescription | | UTP PRM |
| | Accessibility for persons with disabilities and persons with reduced mobility | | Page 86 of 86 |
| Status: PROPOSAL | | TECH-25004 Annex 2 | Original: EN |
| | | | Date: 24.02.2025 |

| | | |
|--|---|--|
| The technical documentation referred to in point 4.2.12 of the LOC&PAS UTP shall include information about the height and offset of the theoretical platform resulting in a vertical gap (δ_v) of 160 mm and in a horizontal gap (δ_h) of 200 mm from the point situated in the central position of the nose of the rolling stock's lowest step on a straight level track. | | |
| 5.3.2.6 (1) | 5.3.2.6 (1) | Restriction of the possibilities given |
| 5.3.2.8 | 5.3.2.8 | New requirement in the specification referenced in Appendix A index [11] |
| 6.2.3.3 | No requirement | New requirement referring to a specific standard on contrast |
| Appendix G – door opening and closing signals | Appendix G – door opening and closing signals | Change of measuring method |

Changes with a specific transition regime:

With regard to the points listed in Table P.2, compliance with the UTP PRM 2022 does not constitute compliance with this UTP.

Projects already in design phase on 28 September 2023, projects in production phase, and units in operation shall comply with the requirement of this UTP in accordance with the respective transition regime set out in Table P.2 starting from 1 January 2026.

For TSI points listed in table P.2, compliance with the previous TSI does not imply compliance with this TSI applicable from 28 September 2023.

Projects already in design phase on 28 September 2023, projects in production phase, and rolling stock in operation shall comply with the requirement of this TSI in accordance with the respective transition regime set out in Table P.2 starting from 28 September 2023.

Table P.2 – specific transition regime

| UTP point(s) | UTP point(s) in previous UTP | Explanation on UTP change | Transition regime | | | |
|----------------|------------------------------|---------------------------|--------------------------|----------------------|------------------|--------------------|
| | | | Design phase not started | Design phase started | Production phase | Units in operation |
| Not applicable | | | | | | |