 OTIF	ROLLING STOCK FREIGHT WAGONS			UTP WAG Page 1 of 94
	Status: ADOPTED	Version: 01	Ref.: A 94-02/3.2011	Original: EN

APTU Uniform Rules (Appendix F to COTIF 1999)

Uniform Technical Prescriptions (UTP) applicable to Rolling Stock, subsystem

FREIGHT WAGONS - (UTP WAG)

These regulations have been developed in accordance with the provisions of APTU, in particularly Article 8, in the version as amended by the OTIF Revision Committee in 2009, which entered into force on 1 December 2010.

For definitions and terms, see also Article 2 of ATMF (Appendix G) and Article 2 of APTU (Appendix F), both Appendices to the 1999 version of the COTIF Convention as applicable since 1 December 2010.

Footnotes are not part of the regulations; they are only included as explanatory information.

The corrections to the Annexes to TSI WAG in force indicated in the part "Errata" of the ERA document "Omnibus after WP32" have been transposed into this document and its annexes.

 OTIF	ROLLING STOCK FREIGHT WAGONS		UTP WAG Page 2 of 94	
	Status: ADOPTED	Version: 01	Ref.: A 94-02/3.2011	Original: EN

List of Annexes to this UTP Freight Wagons (integral part of the UTP)

Ref.	Title
A	Structures and mechanical parts
B	Structures and mechanical parts, Marking of freight wagons
C	Vehicle track interaction and gauging, Kinematic gauge
D	Vehicle track interaction and gauging, Static axle load, dynamic wheel load and linear load
E	Vehicle track interaction and gauging, Wheelset dimensions and tolerances for standard gauge
F	Communication, Vehicle capability to transmit information between ground and vehicle
G	Environmental conditions, Humidity
(H)	Infrastructure and Rolling stock register, Requirements for the freight wagons register - not relevant
I	Braking, Interfaces of braking interoperability constituents
J	Vehicle track interaction and gauging, Bogie and running gear
K	Vehicle track interaction and gauging, Wheelset
L	Vehicle track interaction and gauging, Wheels
M	Vehicle track interaction and gauging, Axle
N	Structures and mechanical parts, Permissible stresses for static test methods
O	Environmental conditions, T_{RIV} requirements
P	Braking performance, assessment of interoperability constituents
Q	Assessment procedures, Interoperability Constituents See also separate UTP: UTP GEN-D
R	Vehicle track interaction and gauging, Longitudinal forces
S	Braking, Braking performance
(T)	Specific cases, Kinematic gauge, Great Britain (Not included)
(U)	Specific cases, Kinematic gauge, 1520 mm track gauge (Not included)
(V)	Specific cases, Braking performance, Great Britain (Not included)
(W)	Specific cases, Kinematic gauge, Finland, static gauge FIN1 (Not included)
(X)	Specific cases, Member States Spain and Portugal (Not included)
Y	Constituents, Bogies and Running Gear
Z	Structures and mechanical parts, Impact (Buffing) Test
(AA)	Assessment procedures, See instead separate UTP: UTP GEN-D
BB	Structures and mechanical parts, Fixing of tail lamps
CC	Structures and mechanical parts, Sources of fatigue loading
(DD)	Assessment of Maintenance Arrangements - Does not exist
EE	Structures and mechanical parts, Footsteps and handrails
FF	Braking, List of approved brake components
(GG)	Specific Cases, Irish loading gauges (Not included)
(HH)	Specific Cases, Republic of Ireland and Northern Ireland Interface between vehicles (Not included)
II	Assessment Procedure : Limits for modifications of freight wagons not requiring new approval
JJ	Open Points
(KK)	Infrastructure and Rolling Stock Register : Infrastructure Register (Not included)

 OTIF	ROLLING STOCK FREIGHT WAGONS			UTP WAG Page 3 of 94
	Status: ADOPTED	Version: 01	Ref.: A 94-02/3.2011	Original: EN

Ref.	Title
LL	Hot axle box detector (HABD) - (ERA Technical Document)
PP	Vehicle identification - Unique vehicle number and letter code indicating the characteristics of the wagon (~ TSI OPE Annex P)
VV	Composite brake blocks – (ERA technical document)
XX	Draw gear - (ERA Technical Document)
YY	Structures and mechanical parts, Strength requirements for certain types of wagon components
ZZ	Structures and mechanical parts, Permissible Stress Based on Elongation Criteria

 OTIF	ROLLING STOCK FREIGHT WAGONS		UTP WAG Page 4 of 94	
	Status: ADOPTED	Version: 01	Ref.: A 94-02/3.2011	Original: EN

Explanatory note:

The texts of this UTP which appear across two columns are identical to corresponding texts of the European Union regulations. Texts which appear in two columns differ; the left-hand column contains the UTP regulations, the right-hand column shows the text in the corresponding EU regulations. The text in the right-hand column is for information only and is not part of the OTIF regulations.

OTIF UTP

Corresponding text in EU regulations ¹ EU ref. ²

With reference to Article 8 of Appendix F (APTU) to the Convention, the following regulations shall apply:

0.1 EQUIVALENCE

Following their adoption by the Committee of Technical Experts, the OTIF regulations included in this document are declared equivalent to the corresponding EU regulations within the meaning of Article 13 of APTU and Article 3a of ATMF.

0.2 TRANSITIONAL PROVISIONS

0.2.1 Wagons which have been technically admitted between 01.12.2010 and the date of entry into force of this UTP shall be subject to the same provisions as wagons which meet the provisions of ATMF Article 19.

0.2.2 The markings referred to in section 1.1.3 shall be applied to a wagon subject to 0.2.1 by the time it is placed into service and those referred to in section 1.1.4 shall be applied to the wagon by the time of its first maintenance service in a workshop.

1. INTRODUCTION

1.1 TECHNICAL SCOPE

1.1.1 This UTP is a technical specification covering the rolling stock subsystem freight wagons as defined in UTP GEN-B Subsystems section 2.6. | This Technical Specification for Interoperability (TSI) concerns the rolling stock subsystem as listed in point 1 of Annex II to Directive 2001/16/EC.

Further information on the rolling stock subsystem is provided in section 2 of this document.

This UTP covers freight wagons only. | TSI

1.1.2 This UTP applies to new, upgraded or | (the corresponding TSI text is in 2.1)

¹ TSI Freight Wagons in force (September 2010) – The Annex to EU Commission Decision 2006/861/EC published in the EU Official Journal L344 on 08.12.2006 – as amended by Commission Decision 2009/107/EC published in the EU Official Journal L45 on 14.02.2009.

² If no EU reference is indicated, it means that the chapter/section number is the same as in the OTIF text.

 OTIF	ROLLING STOCK FREIGHT WAGONS		UTP WAG Page 5 of 94	
	Status: ADOPTED	Version: 01	Ref.: A 94-02/3.2011	Original: EN

OTIF UTP

renewed freight wagons for which technical admission is granted after this UTP has entered into force.

1.1.3

Sections 7.3, 7.4 and 7.5 describe under which conditions and with which exceptions the requirements of this UTP shall be met to new wagons, existing wagons and wagons subject to multilateral agreements.

Corresponding text in EU regulations ¹

EU ref. ²

1.2 GEOGRAPHICAL SCOPE

The geographical scope of this UTP is all the networks in the Contracting States used for international freight traffic. When this document refers to “the OTIF conventional rail system”, the geographical scope of this is as indicated above. International traffic is defined in ATMF Article 2 point I).

TSI is the trans-European conventional rail system network (TEN) as described in Annex I to Directive 2001/16/EC.

1.3 CONTENT OF THIS DOCUMENT

The UTP WAG consists of the regulations included in this document and its annexes.

1.3.1

In accordance with APTU Article 8 § 4, this UTP

In accordance with Article 5(3) of the Directive 2001/16/EC, this TSI 1.3

(a) indicates its intended scope (part of network or vehicles; subsystem or part of subsystem)

(part of the network or rolling stock referred to in Annex I to the Directive; subsystem or part of subsystem referred to in Annex II to the Directive)

– Section 2;

(b) lays down essential requirements for the subsystem concerned and for its interfaces *vis-à-vis* other subsystems

– Section 3;

(c) establishes the functional and technical specifications to be met by the subsystem and its interfaces *vis-à-vis* other subsystems.

If necessary, these specifications may vary according to the use of the subsystem, for example according to the categories of line, hub and/or vehicles

rolling stock provided for in Annex I to the Directive -

– Section 4;

(d) determines the elements of construction (interoperability constituents) and interfaces

interoperability constituents

covered by European specifications, including European standards,

which are necessary to achieve interoperability within the



OTIF UTP

Corresponding text in EU regulations ¹

EU ref. ²

scope of the OTIF conventional rail system
– Section 5;

trans-European conventional rail system

(e) states, in each case under consideration, which procedures are to be used in order to assess the conformity with the provisions of this UTP. These procedures are based on the assessment modules defined in UTP GEN-D.

or the suitability for use. This includes in particular the modules defined in Decision 93/465/EEC or, where appropriate, the specific procedures to be used to assess either the conformity or the suitability for use of the interoperability constituents and “EC verifications of subsystems”

– Section 6;

(f) indicates the strategy for implementing this UTP.

TSI.

In particular, it is necessary to specify the stages to be completed in order to make a gradual transition from the existing situation to the final situation in which compliance with the

UTP shall be the norm;
– Section 7;

TSI

(g) indicates, for the staff concerned, the professional qualifications and health and safety conditions at work required for the operation and maintenance of the subsystem concerned, as well as for the implementation of this UTP

TSI

– Section 4.

Moreover, in accordance with Article 8 § 2 of Appendix F (APTU) to the Convention, provisions may be made for specific cases for each UTP; these provisions are indicated in section 7.

Article 5(5) of the Directive, TSI;

Lastly, this UTP

TSI

also comprises, in section 4, the operating and maintenance rules specific to the scope indicated in paragraphs 1.1 and 1.2 above.

 OTIF	ROLLING STOCK FREIGHT WAGONS		UTP WAG Page 7 of 94	
	Status: ADOPTED	Version: 01	Ref.: A 94-02/3.2011	Original: EN

OTIF UTP

Corresponding text in EU regulations ¹ EU ref. ²

1.4 ABBREVIATIONS AND DEFINITIONS

- **APTU** means Appendix F to COTIF 1999 in the revised version that entered into force on 1 December 2010.
- **ATMF** means Appendix G to COTIF 1999 in the revised version that entered into force on 1 December 2010.
- **RIV** means “Regolamento Internazionale Veicoli”, Agreement governing the exchange and use of wagons between railway undertakings, in the revised edition of 1 January 2004.
- **All definitions** included in Article 2 of ATMF and APTU apply to this UTP.
- **authorised representative**, see definition in UTP GEN-D

2. THE ROLLING STOCK SUBSYSTEM AND ITS FUNCTIONS

2.1 DEFINITION OF THE SUBSYSTEM

(See also section 1.2)

The rolling stock, which is the subject of this TSI, comprises the freight wagons likely to travel on all or part of the trans-European conventional rail network.

The freight wagons include rolling stock designed to carry lorries and/or cars in “piggy-back” traffic – without driver and passengers in the road vehicle being carried.

(The corresponding text is contained in section 1.1.2)

This TSI applies to new, upgraded or renewed freight wagons placed in service after entering this TSI into force.

This TSI does not apply to wagons being subject to a contract already signed before the date of entry into force of this TSI.

The section 7.3., 7.4 and 7.5 describe in which conditions and with which exceptions the TSI requirements shall be met.

The rolling stock freight wagons subsystem includes the structure of the vehicles, braking equipment, coupling and running gear (bogies, axles etc.) suspension, doors and communication systems.

The procedures for maintenance work allowing the mandatory corrective and preventive maintenance to ensure safe operation and the performance required are also included in this

UTP.

| TSI.

 OTIF	ROLLING STOCK FREIGHT WAGONS		UTP WAG Page 8 of 94	
	Status: ADOPTED	Version: 01	Ref.: A 94-02/3.2011	Original: EN

OTIF UTP

Corresponding text in EU regulations ¹

EU ref. ²

They are specified in section 4.2.8.

Requirements relating to the noise generated by freight wagons are excluded from this

UTP, | TSI,
except maintenance issue, as there is a separate

UTP, | TSI,
dealing with the noise generated by freight wagons, locomotives, multiple units and coaches.

2.2 FUNCTIONS OF SUBSYSTEM

The freight wagons shall contribute to the following functions:

- “Load freight” – the freight wagons provide the means to operate and carry the load safely.
- “Move rolling stock” – the freight wagons are able to be moved safely on the network and contribute to the braking of the train.
- “Maintain and provide data on rolling stock, infrastructure and timetable” – Specification of the maintenance file and certification of the maintenance establishments allow the control of the freight wagon maintenance. Data relating to the freight wagons is provided in the National Vehicle Register and the OTIF Register of admitted types of vehicles | rolling stock register, ³
marked on the wagons, and eventually by means of vehicle to vehicle and vehicle to ground communication devices.
- “Operate a train” – the freight wagon shall be able to be operated safely under all expected environmental conditions and in certain expected situations.
- “Provide services for freight customers” - Data relating to the freight wagon to support freight services for customers is provided in the National Vehicle Register and the OTIF Register of admitted types of vehicles | rolling stock register,

2.3 INTERFACES OF SUBSYSTEM

The rolling stock freight wagons subsystem experiences the following interfaces to:

Control and command and signalling subsystem -

- Rolling stock parameters which influence ground based train monitoring systems
 - Hot axle bearing detectors
 - Electrical detection of the wheelset
 - Axle counters
- Braking performance

Traffic operation and management subsystem

- Interface between vehicles, between sets of vehicles and between trains
- Doors closing and locking

³ In the recent Interoperability Directive (2008/57/EC), the EU Rolling stock register has been replaced by the “European register of authorised types”.

 OTIF	ROLLING STOCK FREIGHT WAGONS		UTP WAG Page 9 of 94	
	Status: ADOPTED	Version: 01	Ref.: A 94-02/3.2011	Original: EN

OTIF UTP

Corresponding text in EU regulations ¹

EU ref. ²

- Securing of freight
- Loading rules
- Dangerous goods
- Longitudinal compressive forces
- Braking performance
- Aerodynamic effects
- Maintenance

Telematics applications for freight service subsystem

- Rolling stock reference data bases
- Wagon and intermodal unit operational database

Infrastructure subsystem

- Interface between vehicles, between sets of vehicles and between trains
- Buffers
- Kinematic gauge
- Static axle load, dynamic wheel load and linear load
- Vehicle dynamic behaviour
- Braking performance
- Fire protection

Energy subsystem

- Electrical protection

Noise Aspect

- Maintenance

Appendix C (RID) to the COTIF Convention | **The Council Directive 96/49/EC ⁴ and its Annex (RID).**

- Dangerous goods

3. ESSENTIAL REQUIREMENTS

3.1 GENERAL

In the scope of the present UTP | TSI compliance with the specifications described:

- in section 4 for the subsystem
- and in section 5 for the interoperability constituents,

as demonstrated by a positive result of the assessment of:

- conformity and/or suitability for use of the interoperability constituents,
- and of verification of the subsystem, as described in section 6

ensures fulfilment of the relevant essential requirements quoted in section 3 of this UTP. | TSI.

Nevertheless, if part of the essential requirements are covered by national rules because of:

- open and reserved points declared in the UTP, | TSI,
- a derogation

⁴ This Directive has been replaced by Directive 2008/68/EC including the inland transport of dangerous goods

 OTIF	ROLLING STOCK FREIGHT WAGONS		UTP WAG Page 10 of 94	
	Status: ADOPTED	Version: 01	Ref.: A 94-02/3.2011	Original: EN

OTIF UTP

according to ATMF

- specific cases described in section 7.7 of the present UTP,

the corresponding conformity assessment shall be carried out according to procedures under the responsibility of the Contracting State concerned.

Corresponding text in EU regulations ¹ EU ref. ²

under article 7 of Directive 2001/16/EC,

TSI,

Member State

Subsystems and interoperability constituents including interfaces shall meet the relevant essential requirements set out in UTP GEN-A "Essential Requirements".

Under Article 4(1) of Directive 2001/16/EC, the trans-European conventional rail system, subsystems and interoperability constituents including interfaces shall meet the relevant essential requirements set out in Annex III to the Directive 2001/16/EC.

3.2 THE ESSENTIAL REQUIREMENTS RELATE TO:

- Safety
- Reliability and availability
- Health
- Environmental protection
- Technical compatibility.

These requirements include general requirements, and requirements specific to each subsystem.

3.3 GENERAL REQUIREMENTS

Essential Requirements of UTP 1-A

| *Annex III to Directive 2001/16/EC.*

3.3.1 Safety

Essential Requirement 1.1.1

The design, construction or assembly, maintenance and monitoring of safety-critical components and, more particularly, of the components involved in train movements must be such as to guarantee safety at the level corresponding to the aims laid down for the network, including those for specific degraded situations.

This essential requirement is satisfied by the functional and technical specifications in sections:

- 4.2.2.1 (interface between vehicles)
- 4.2.2.2 (safe access and egress)
- 4.2.2.3 (strength of main vehicle structure)
- 4.2.2.5 (marking of freight wagons)
- 4.2.2.5.1 (unique vehicle number)
- 4.2.4 (braking)
- 4.2.6 (environmental conditions)
- 4.2.7 (system protection), except 4.2.7.3 (electrical protection)
- 4.2.8 (maintenance)

Essential Requirement 1.1.2:

The parameters involved in the wheel/rail contact must meet the stability requirements needed in order to guarantee safe movement at the maximum authorised

 OTIF	ROLLING STOCK FREIGHT WAGONS			UTP WAG Page 11 of 94
	Status: ADOPTED	Version: 01	Ref.: A 94-02/3.2011	Original: EN

OTIF UTP

Corresponding text in EU regulations ¹

EU ref. ²

speed. This essential requirement is satisfied by the functional and technical specifications in sections:

- 4.2.3.2 (axle and wheel loading)
- 4.2.3.4 (vehicle dynamic behaviour)
- 4.2.3.5 (longitudinal compressive forces)

Essential Requirement 1.1.3:

The components used must withstand any normal or exceptional stresses that have been specified during their period in service. The safety repercussions of any accidental failures must be limited by appropriate means.

This essential requirement is satisfied by the functional and technical specifications in sections:

- 4.2.2.1 (interface between vehicles)
- 4.2.2.2 (safe access and egress for rolling stock)
- 4.2.2.3 (strength of main vehicle structure)
- 4.2.2.4 (doors closing)
- 4.2.2.6 (dangerous goods)
- 4.2.3.3.2 (hot axle box detection)
- 4.2.4 (braking)
- 4.2.6 (environmental conditions)
- 4.2.8 (maintenance)

Essential Requirement 1.1.4:

The design of fixed installations and rolling stock and the choice of the materials used must be aimed at limiting the generation, propagation and effects of fire and smoke in the event of a fire.

This essential requirement is satisfied by the functional and technical specifications in sections

- 4.2.7.2 (fire safety)

Essential Requirement 1.1.5:

Any devices intended to be handled by users must be so designed as not to impair the safe operation of the devices or the health and safety of users if used foreseeably in a manner not in accordance with the posted instructions.

This essential requirement is satisfied by the functional and technical specifications in sections:

- 4.2.2.1 (interface between vehicles)
- 4.2.2.2 (safe access and egress for rolling stock)
- 4.2.2.4 (doors closing)
- 4.2.4 (braking)

3.3.2 Reliability and availability

Essential Requirement 1.2:

The monitoring and maintenance of fixed or movable components that are involved in train movements must be organised, carried out and quantified in such a manner as to maintain their operation under the intended conditions.

This essential requirement is satisfied by the functional and technical specifications in sections:

- 4.2.2.1 (interface between vehicles)

 OTIF	ROLLING STOCK FREIGHT WAGONS		UTP WAG Page 12 of 94	
	Status: ADOPTED	Version: 01	Ref.: A 94-02/3.2011	Original: EN

OTIF UTP

Corresponding text in EU regulations ¹

EU ref. ²

- 4.2.2.2 (safe access and egress for rolling stock)
- 4.2.2.3 (strength of main vehicle structure)
- 4.2.2.4 (doors closing)
- 4.2.2.5 (wagon markings)
- 4.2.2.6 (dangerous goods)
- 4.2.4.1 (braking system)
- 4.2.7.2.2.5 (maintenance of the fire protection measures)
- 4.2.8 (maintenance)

3.3.3 Health

Essential Requirement 1.3.1:

Materials likely, by virtue of the way they are used, to constitute a health hazard to those having access to them must not be used in trains and railway infrastructure. This essential requirement is satisfied by the functional and technical specifications in sections:

- 4.2.8 (maintenance)

Essential Requirement 1.3.2:

Those materials must be selected, deployed and used in such a way as to restrict the emission of harmful and dangerous fumes or gases, particularly in the event of fire.

This essential requirement is satisfied by the functional and technical specifications in sections:

- 4.2.7.2 (fire safety)
- 4.2.8 (maintenance)

3.3.4 Environmental protection

Essential Requirement 1.4.1

The environmental impact of establishment and operation of the rail system must be assessed and taken into account at the design stage of the system in accordance with the

| Community

provisions in force in the Contracting State where the application is made. (Not to be considered as an open point in this UTP).

This essential requirement is not relevant within the scope of this UTP.

| TSI.

Essential Requirement 1.4.2

The materials used in the trains and infrastructure must prevent the emission of fumes or gases which are harmful and dangerous to the environment, particularly in the event of fire.

This essential requirement is satisfied by the functional and technical specifications in sections:

- 4.2.7.2 (fire safety)
- 4.2.8 (maintenance)

 OTIF	ROLLING STOCK FREIGHT WAGONS		UTP WAG Page 13 of 94	
	Status: ADOPTED	Version: 01	Ref.: A 94-02/3.2011	Original: EN

OTIF UTP

| Corresponding text in EU regulations ¹

EU ref. ²

Essential Requirement 1.4.3

The rolling stock and energy-supply systems must be designed and manufactured in such a way as to be electromagnetically compatible with the installations, equipment and public or private networks with which they might interfere.

This essential requirement is satisfied by the functional and technical specifications in sections:

- 4.2.3.3 (communication between vehicle and ground)

Essential Requirement 1.4.4

Operation of the
OTIF

| Trans-European

conventional rail system must respect existing regulations on noise pollution.

This essential requirement is satisfied by the functional and technical specifications in sections:

- 4.2.8 (maintenance)
- 4.2.3.4 (vehicle dynamic behaviour)

Essential Requirement 1.4.5

Operation of the
OTIF

| Trans-European

conventional rail system must not give rise to an inadmissible level of ground vibrations for the activities and areas close to the infrastructure and in a normal state of maintenance.

This essential requirement is satisfied by the functional and technical specifications in sections:

- 4.2.3.2 (static axle load, dynamic wheel load and linear load)
- 4.2.3.4 (vehicle dynamic behaviour)
- 4.2.8 (maintenance)

3.3.5 Technical compatibility

Essential Requirement 1.5

The technical characteristics of the infrastructure and fixed installations must be compatible with each other and with those of the trains to be used on the
OTIF | Trans-European
conventional rail system.

If compliance with these characteristics proves difficult on certain sections of the network, temporary solutions, which ensure compatibility in the future, may be implemented.

This essential requirement is satisfied by the functional and technical specifications in sections:

- 4.2.3.1 (kinematic gauge)
- 4.2.3.2 (static axle load, dynamic wheel load and linear load)
- 4.2.3.4 (vehicle dynamic behaviour)
- 4.2.3.5 (longitudinal compressive forces)
- 4.2.4 (braking)
- 4.2.8 (maintenance)

 OTIF	ROLLING STOCK FREIGHT WAGONS		UTP WAG Page 14 of 94	
	Status: ADOPTED	Version: 01	Ref.: A 94-02/3.2011	Original: EN

OTIF UTP

Corresponding text in EU regulations ¹

EU ref. ²

3.4 REQUIREMENTS SPECIFIC TO THE ROLLING STOCK SUBSYSTEM

3.4.1 Safety

Essential Requirement 2.4.1

The structure of the rolling stock and of the links between vehicles must be designed in such a way as to protect the passenger and driving compartments in the event of collision or derailment.

This essential requirement is not relevant within the scope of this UTP.

| TSI.

The electrical equipment must not impair the safety and functioning of the control and command and signalling installations.

For wagons subject to section 7.6.4, this essential requirement is met by the functional and technical specifications in section:

- 4.2.3.3.3 (Electrical or electromagnetic interference)

For wagons not subject to section 7.6.4, but equipped with electrical installations, see the note at the beginning of chapter 6.

This essential requirement is not relevant within the scope of this TSI. ⁵

The braking techniques and the stresses exerted must be compatible with the design of the track, engineering structures and signalling systems.

This essential requirement is satisfied by the functional and technical specifications in sections:

- 4.2.3.5 (longitudinal compressive forces)
- 4.2.4 (braking)

Steps must be taken to prevent access to electrically-live constituents in order not to endanger the safety of persons.

This essential requirement is satisfied by the functional and technical specifications in sections:

- 4.2.2.5 (marking of freight wagons)
- 4.2.7.3 (electrical protection)
- 4.2.8 (maintenance)

In the event of danger, devices must enable passengers to inform the driver and accompanying staff to contact him.

This essential requirement is not relevant within the scope of this UTP.

| TSI.

The access doors must incorporate an opening and closing system, which guarantees passenger safety.

This essential requirement is not relevant within the scope of this UTP.

| TSI.

Emergency exits must be provided and indicated.

⁵ Requirements applicable to wagons subject to section 7.6.4 ("passe-partout wagons") have been included in TSI WAG in accordance with EU Commission Decision 2009/107/EC

 OTIF	ROLLING STOCK FREIGHT WAGONS		UTP WAG Page 15 of 94	
	Status: ADOPTED	Version: 01	Ref.: A 94-02/3.2011	Original: EN

OTIF UTP

| Corresponding text in EU regulations ¹

EU ref. ²

This essential requirement is not relevant within the scope of this UTP. | TSI.

Appropriate provisions must be laid down to take account of the particular safety conditions in very long tunnels.

This essential requirement is not relevant within the scope of this UTP. | TSI.

An emergency lighting system of sufficient intensity and duration is compulsory on board trains.

This essential requirement is not relevant within the scope of this UTP. | TSI.

Trains must be equipped with a public address system which provides a means of communication to the public from on-board staff and ground control.

This essential requirement is not relevant within the scope of this UTP. | TSI.

3.4.2 Reliability and availability

Essential Requirement 2.4.2

The design of the vital equipment, of the running, traction and braking equipment and of the control and command system must be such as to enable the train to continue its mission, in a specific degraded situation, without adverse consequences for the equipment remaining in service.

This essential requirement is satisfied by the functional and technical specifications in sections:

- 4.2.4.1.2.6 (wheel-slide-protection, see also section 5.3.3.3 and Annex I)
- 5.4.1.2 (Draw gear)
- 5.4.2.1 (Bogie and running gear)
- 5.4.2.2 (Wheelsets)
- 5.4.3.8 (Isolating device for distributor)

3.4.3 Technical compatibility

Essential Requirement 2.4.3

The electrical equipment must be compatible with the operation of the control and command and signalling installations.

This essential requirement is not relevant within in the scope of this UTP. | TSI.

In the case of electric traction, the characteristics of the current-collection devices must be such as to enable trains to travel under the energy-supply systems for the OTIF | trans-European conventional rail system.

This essential requirement is not relevant within the scope of this UTP. | TSI.

The characteristics of the rolling stock must be such as to allow it to travel on any line on which it is expected to operate.

This essential requirement is satisfied by the functional and technical specifications in sections:

- 4.2.2.3 (strength of main vehicle structure)

 OTIF	ROLLING STOCK FREIGHT WAGONS		UTP WAG Page 16 of 94	
	Status: ADOPTED	Version: 01	Ref.: A 94-02/3.2011	Original: EN

OTIF UTP

Corresponding text in EU regulations ¹

EU ref. ²

- 4.2.3.1 (kinematic gauge)
- 4.2.3.2 (static axle load, dynamic wheel load and linear load)
- 4.2.3.3 (rolling stock parameters which influence ground based train monitoring systems)
- 4.2.3.4 (vehicle dynamic behaviour)
- 4.2.3.5 (longitudinal compressive forces)
- 4.2.4 (braking)
- 4.2.6 (environmental conditions)
- 4.2.8 (maintenance)
- 4.8.2 (rolling stock register)

3.5 REQUIREMENTS SPECIFIC TO MAINTENANCE

3.5.1 Health and safety

Essential Requirement 2.5.1

The technical installations and the procedures used in the centres must ensure the safe operation of the subsystem and not constitute a danger to health and safety.

This essential requirement is satisfied by the functional and technical specifications in sections:

- 4.2.8 (maintenance)

3.5.2 Environmental protection

Essential Requirement 2.5.2

The technical installations and the procedures used in the maintenance centres must not exceed the permissible levels of nuisance with regard to the surrounding environment.

This essential requirement is not satisfied by the functional and technical specifications within the scope of this UTP.

| TSI.

3.5.3 Technical compatibility

Essential Requirement 2.5.3

The maintenance installations for conventional rolling stock must be such as to enable safety, health and comfort operations to be carried out on all stock for which they have been designed.

This essential requirement is satisfied by the functional and technical specifications in sections:

- 4.2.8 (maintenance)

3.6 REQUIREMENTS SPECIFIC TO OTHER SUBSYSTEMS CONCERNING ALSO THE ROLLING STOCK SUBSYSTEM

3.6.1 Infrastructure Subsystem

3.6.1.1 Safety

Essential Requirement 2.1.1

 OTIF	ROLLING STOCK FREIGHT WAGONS		UTP WAG Page 17 of 94	
	Status: ADOPTED	Version: 01	Ref.: A 94-02/3.2011	Original: EN

OTIF UTP

Corresponding text in EU regulations ¹

EU ref. ²

Appropriate steps must be taken to prevent access to or undesirable intrusions into installations.

Steps must be taken to limit the dangers to which persons are exposed, particularly when trains pass through stations.

Infrastructure to which the public has access must be designed and made in such a way as to limit any human safety hazards (stability, fire, access, evacuation, platforms, etc.).

Appropriate provisions must be laid down to take account of the particular safety conditions in very long tunnels.

This essential requirement is not relevant within the scope of this UTP.

| TSI.

3.6.2 Energy Subsystem

3.6.2.1 Safety

Essential Requirement 2.2.1

Operation of the energy-supply systems must not impair the safety either of trains or of persons (users, operating staff, trackside dwellers and third parties).

This essential requirement is not relevant within the scope of this UTP.

| TSI.

3.6.2.2 Environmental protection

Essential Requirement 2.2.2

The functioning of the electrical or thermal energy-supply systems must not interfere with the environment beyond the specified limits.

This essential requirement is not relevant within the scope of this UTP.

| TSI.

3.6.2.3 Technical compatibility

Essential Requirement 2.2.3

The electricity/thermal energy supply systems used must:

- enable trains to achieve the specified performance levels;
- in the case of electricity energy supply systems, be compatible with the collection devices fitted to the trains.

This essential requirement is not relevant within the scope of this UTP.

| TSI.

3.6.3 Control and command and signalling

3.6.3.1 Safety

Essential Requirement 2.3.1

The control and command and signalling installations and procedures used must enable trains to travel with a level of safety which corresponds to the objectives set for the network. The control and command and signalling systems should continue to provide for safe passage of trains permitted to run under degraded conditions.

This essential requirement is not relevant within the scope of this UTP.

| TSI.

 OTIF	ROLLING STOCK FREIGHT WAGONS		UTP WAG Page 18 of 94	
	Status: ADOPTED	Version: 01	Ref.: A 94-02/3.2011	Original: EN

OTIF UTP

Corresponding text in EU regulations ¹

EU ref. ²

3.6.3.2 Technical compatibility

Essential Requirement 2.3.2

All new infrastructures and all new rolling stock manufactured or developed after adoption of the UTP Control Command and Signalling systems (CCS) by the Committee of Technical Experts must be tailored to use of those systems. The control and command and signalling equipment installed in the train drivers' cabs must permit normal operation, under the specified conditions, throughout the rail system.

This essential requirement is satisfied by the functional and technical specifications in sections:

- 4.2.3.3.1 (electrical resistance)
- 4.2.4 (braking)

3.6.4 Operation and traffic management

3.6.4.1 Safety

Essential Requirement 2.3.2

Alignment of the network operating rules and the qualifications of drivers and on-board staff and of the staff in the control centres must be such as to ensure safe operation, bearing in mind the different requirements of cross-border and domestic services.

The maintenance operations and intervals, the training and qualifications of the maintenance and control centre staff and the quality assurance system set up by the operators concerned in the control and maintenance centres must be such as to ensure a high level of safety.

This essential requirement is satisfied by the functional and technical specifications in sections:

- 4.2.2.5 (marking of freight wagons)
- 4.2.2.5.1 (unique vehicle number)
- 4.2.4 (braking)
- 4.2.8 (maintenance)

3.6.4.2 Reliability and availability

Essential Requirement 2.6.2

The maintenance operations and periods, the training and qualifications of the maintenance and control centre staff and the quality assurance system set up by the operators concerned in the control and maintenance centres must be such as to ensure a high level of system reliability and availability.

This essential requirement is satisfied by the functional and technical specifications in sections:

- 4.2.8 (maintenance)

3.6.4.3 Technical compatibility

Essential Requirement 2.6.3

Alignment of the network operating rules and the qualifications of drivers, on-board staff and traffic managers must be such as to ensure operating efficiency on the OTIF trans-European

 OTIF	ROLLING STOCK FREIGHT WAGONS		UTP WAG Page 19 of 94	
	Status: ADOPTED	Version: 01	Ref.: A 94-02/3.2011	Original: EN

OTIF UTP

Corresponding text in EU regulations ¹ EU ref. ²

conventional rail system, bearing in mind the different requirements of crossborder and domestic services.

This essential requirement is not relevant within the scope of this UTP. | TSI.

3.6.5 Telematics applications for freight and passengers

3.6.5.1 Technical compatibility

Essential Requirement 2.7.1

The essential requirements for Telematics applications guarantee a minimum quality of service for passengers and carriers of goods, particularly in terms of technical compatibility.

Steps must be taken to ensure:

- that the databases, software and data communication protocols are developed in a manner allowing maximum data interchange between different applications and operators, excluding confidential commercial data;
- easy access to the information for users.

This essential requirement is not relevant within the scope of this UTP. | TSI.

3.6.5.2 Reliability and availability

Essential Requirement 2.7.2

The methods of use, management, updating and maintenance of these databases, software and data communication protocols must guarantee the efficiency of these systems and the quality of the service.

This essential requirement is not relevant within the scope of this

3.6.5.3 Health

Essential Requirement 2.7.3

The interfaces between these systems and users must comply with the minimum rules on ergonomics and health protection.

This essential requirement is not relevant within the scope of this UTP. | TSI.

3.6.5.4 Safety

Essential Requirement 2.7.4

Suitable levels of integrity and dependability must be provided for the storage or transmission of safety-related information.

This essential requirement is not relevant within the scope of this UTP. | TSI.

 OTIF	ROLLING STOCK FREIGHT WAGONS		UTP WAG Page 20 of 94	
	Status: ADOPTED	Version: 01	Ref.: A 94-02/3.2011	Original: EN

OTIF UTP

| Corresponding text in EU regulations

EU ref.

4. CHARACTERISATION OF THE SUBSYSTEM

4.1 INTRODUCTION

The OTIF conventional rail system

| The trans-European conventional rail system, to which Directive 2001/16/EC⁶ applies and

of which the rolling stock freight wagons subsystem is a part, is an integrated system whose compatibility shall be verified. This compatibility shall be checked in particular with regard to the specifications of the subsystem, its interfaces vis-à-vis the system in which it is integrated, as well as the operating and maintenance rules.

The functional and technical specifications of the subsystem and its interfaces, described in sections 4.2 and 4.3, do not impose the use of specific technologies or technical solutions, except where this is strictly necessary for the interoperability of the

OTIF

| trans-European

conventional rail network. But innovative solutions for interoperability may require new specifications and / or new assessment methods. In order to allow technological innovation, these specifications and assessment methods shall be developed by the process described in sections 6.1.2.3 and 6.2.2.2.

Taking account of all the applicable essential requirements, the rolling stock freight wagons subsystem is characterised in the present section 4.

4.2 FUNCTIONAL AND TECHNICAL SPECIFICATIONS OF THE SUBSYSTEM

4.2.1 General

In light of the essential requirements in section 3, the functional and technical specifications of the rolling stock freight wagons subsystem are arranged as follows:

- Structures and mechanical parts
- Vehicle track interaction and gauging
- Braking
- Communication
- Environmental conditions
- System protection
- Maintenance

These headings include the basic parameters as follows:

Structures and mechanical parts

- Interface (e. g. coupling) between vehicles, between set of vehicles and between trains
- Safe access and egress for rolling stock
- Strength of main vehicle structure
- Securing of freight
- Doors closing and locking
- Marking of freight wagons

⁶ This version of the Interoperability Directive has been replaced by 2008/57/EC

 OTIF	ROLLING STOCK FREIGHT WAGONS		UTP WAG Page 21 of 94	
	Status: ADOPTED	Version: 01	Ref.: A 94-02/3.2011	Original: EN

OTIF UTP

Corresponding text in EU regulations

EU ref.

- Dangerous goods

Vehicle track interaction and gauging

- Kinematic gauge
- Static axle load, dynamic wheel load and linear load
- Rolling stock parameters which influence ground based train monitoring systems
- Vehicle dynamic behaviour
- Longitudinal compressive forces

Braking

- Braking performance

Communication

- Vehicle capability to transmit information from vehicle to vehicle
- Vehicle capability to transmit information between ground and vehicle

Environmental conditions

- Aerodynamic effects
- Cross winds

System protection

- Emergency Measures
- Fire safety
- Electrical protection

Maintenance

- Maintenance file

For each basic parameter a General paragraph introduces the following paragraphs. These following paragraphs detail the conditions to be met in order to fulfil the requirements introduced in the General paragraph.

4.2.2 Structures and mechanical parts :

4.2.2.1 Interface (e. g. coupling) between vehicles, between set of vehicles and between trains

4.2.2.1.1 General

Wagons shall have resilient buffing and draw gear at both ends.

Rakes of wagons, which are always operated as a unit when in service, are considered to be a single wagon for the application of this requirement. The interfaces between these wagons shall incorporate a resilient coupling system, which is capable of withstanding the forces due to the intended operational conditions.

Trains, which are always operated as a unit in service, are considered to be a single wagon for the application of this requirement. They also shall incorporate a resilient coupling system as above. If they do not have a standard screw coupler and buffers they shall have the facility to fit an emergency coupler at both ends.

4.2.2.1.2 Functional and technical specifications

4.2.2.1.2.1 Buffers

 OTIF	ROLLING STOCK FREIGHT WAGONS		UTP WAG Page 22 of 94	
	Status: ADOPTED	Version: 01	Ref.: A 94-02/3.2011	Original: EN

OTIF UTP

| Corresponding text in EU regulations

EU ref.

When buffers are fitted, two identical buffers shall be fitted at a wagon end. These buffers shall be of a compressible type.

The height of the centre line of the buffing gear shall be between 940 mm and 1065 mm above rail level in all conditions of loading. The standard distance between buffer centrelines shall be nominally 1750 mm symmetrically about the centreline of the freight wagon.

Buffers shall be sized so that in horizontal curves and reverse curves, it is not possible for vehicles to lock buffers. The minimum acceptable overlap shall be 50 mm.

The Infrastructure

UTP

| TSI

specifies the minimum curve radius and reverse curve characteristics.

Wagons fitted with buffers with a stroke in excess of 105 mm shall be fitted with four identical buffers (elastic systems, stroke) exhibiting the same design characteristics.

If interchangeability of the buffers is required a free space on the headstock shall be provided for the supporting plate. The buffer shall be fixed to the wagon headstock by means of four M24 locked fasteners of a quality class which provides a yield strength of at least 640 N/mm² (see Annex A fig. A1).

- Buffer characteristics

Buffers shall have a minimum stroke of 105 mm +0/-5 mm and a dynamic energy absorption capacity of at least 30 kJ.

The buffer heads shall be convex with a radius of curvature of their spherical working surface of 2750 mm ± 50 mm.

Minimum height of the buffer head shall be 340 mm equally spaced from the longitudinal buffer axis.

Buffers shall have an identification mark. The identification mark shall contain at least the buffer stroke in "mm" and a value for the energy absorption capacity of the buffer.

For wagons subject to section 7.6.4, the buffers must be fitted with a guiding device for the plunger which prevents the latter from revolving freely around its longitudinal axis. The permitted tolerance for rotation is ± 2° for buffers when new. 2009/
107/EC
JJ.2, 2.1

For other wagons not subject to section 7.6.4, see the note at the beginning of chapter 6.

4.2.2.1.2.2 Draw gear

WAG

The standard draw gear between vehicles shall be non-continuous and comprises a screw coupling permanently attached to the hook, a draw hook and a draw bar with an elastic system

The height of the centre line of the draw hook shall be between 920 mm and 1045 mm above rail level in all conditions of loading.

Each wagon end shall have a facility for supporting a coupling when it is not in use. No part of the coupler assembly shall reach below 140 mm above rail level when at its lowest position due to wear and suspension travel.

- Draw gear characteristics:

The elastic system of the draw gear shall have as a minimum a static capacity of absorption of 8 kJ. The draw hook and the draw bar shall withstand a force of 1000 kN without breaking. The screw coupler shall withstand a force of 850 kN without breaking. The breaking strength of the screw coupler shall be lower than the breaking strength of other parts of the draw gear.

⁷ The coupling hook pin and the draw hook shall not be considered as part of the screw coupling weight.

 OTIF	ROLLING STOCK FREIGHT WAGONS			UTP WAG Page 23 of 94
	Status: ADOPTED	Version: 01	Ref.: A 94-02/3.2011	Original: EN

OTIF UTP

Corresponding text in EU regulations

EU ref.

The screw coupler shall be designed such that in-train forces cannot cause the coupler to unscrew involuntarily.

The maximum weight of the screw coupler shall not exceed 36 kg. ⁷

The dimensions of the screw couplers and draw hooks see Annex A fig A6 shall be as shown in Annex A figures A2 and A3. The coupler length measured from the inside face of the coupler bow to the draw-bar pin centre-line shall be:

- 986 mm +10/-5 mm with completely screwed-out coupler
- 750 mm ± 10 mm with completely screwed-in coupler.

For wagons subject to section 7.6.4, the draw gear must also comply with the following provisions (a), (b), (c) and (d):

2009/
107/EC
JJ.2, 2.1

(a) The intermediate draw gear of each set of permanently coupled wagons (or multiple wagons) must have a breaking strength in traction higher than that of the end draw gear;

(b) Annex XX which contains specifications relating to the following issues:

The ERA Technical Document on “additional specifications applicable to the draw gear” related to the following issues also applies (the prEN 15551 is expected to be published in April 2009):

- dynamic energy capacity,
- attachments,
- stroke and anti-rotation device,
- mechanical resistance,
- elastic characteristics,
- markings,
- buffer override calculation and buffer plate material,
- dimension of the draw bar aperture,

ERA
Tech
doc

(c) For the mechanical resistance of assemblies, the draw gear (excluding elastic device), draw hooks, and screw coupling shall be designed for a life time of thirty years. Twenty years may be agreed at the customer's request;

(d) The following table shows the range of forces and number of cycles to be applied for the dynamic type test:

Operational requirements			Range of forces to be applied		
Lifecycle (years)	Survival probability (%)	Safety factor (f _N)	Designation	Step 1	Step 2
			1 MN	ΔF1 = 200 kN	ΔF2 = 675 kN
			1.2 MN	ΔF1 = 240 kN	ΔF2 = 810 kN
			1.5 MN	ΔF1 = 300 kN	ΔF2 = 1015 kN
				N1 in cycles	N2 in cycles
20	97.5	1.7	All	10 ⁶	1.45 × 10 ³
30	97.5	1.7	All	1.5 × 10 ⁶	2.15 × 10 ³

The dynamic type tests have to be carried out on three draw gears without elastic device. All three samples have to endure the tests without showing any damage. They shall not show any cracks, and the tensile force shall not drop below 1000 kN.

For other wagons not subject to section 7.6.4, see the note at the beginning of

 OTIF	ROLLING STOCK FREIGHT WAGONS		UTP WAG Page 24 of 94	
	Status: ADOPTED	Version: 01	Ref.: A 94-02/3.2011	Original: EN

OTIF UTP

chapter 6.

Corresponding text in EU regulations

EU ref.

4.2.2.1.2.3 Interaction of draw- and buffing-gear

The characteristics of the buffers and draw gear shall be designed in order to enable the safe transit of curves in the track with a radius of 150 m.

Two wagons with bogies coupled on straight track with touching buffers shall generate compressive forces no higher than 250 kN on a 150 m radius curve.

There is no requirement specified for two axle wagons.

- Draw gear and buffing gear characteristics

The distance between the front edge of a draw-hook opening and the front side of the fully extended buffers shall be 355 mm +45/-20 mm in the new condition as shown in Annex A fig. A4.

4.2.2.2 Safe access and egress for rolling stock

Vehicles shall be designed so that staff is not exposed to undue risk during coupling and uncoupling. If screw couplers and side buffers are used, the required spaces shown in Annex A fig. A5 shall be free of fixed parts. Connecting cables and flexible hoses may be inside this space. There shall be no devices under the buffers that hinder the access to the space.

The clearance above the draw hook is viewed in Annex A fig. A7.

If a combined automatic and screw coupler is fitted it is permissible for the auto coupler head to infringe the Berne rectangle on the left hand side (as viewed Annex A fig. A5) when it is stowed and the screw coupler is in use.

There shall be a handrail under each buffer. The handrails shall withstand the loads, which are applied by the shunters while accessing the space between the buffers.

At the ends of a wagon there shall be no fixed parts within 40 mm of a vertical plane placed at the end of the fully compressed buffers.

Except for wagons used only in fixed formation trains, there shall be at least one step and one handrail for shunters at each side of the vehicle. There shall be sufficient space above and around the steps that the safety of the shunter is ensured. Steps and handrails shall be designed to withstand the loads that are applied by the shunter. Steps shall be at least 150 mm from a vertical plane at the end of the fully compressed buffers (see Annex A figure A5). Steps and areas, which provide access for operation, loading and unloading, shall be slip resistant (see Annex EE).

At each end of a wagon that may form the end of a train, there shall be devices for mounting a taillight. Steps and handrails shall be provided where necessary to enable easy access.

The handrails and footsteps shall be inspected at normal maintenance periods and remedial action taken if signs of significant damage, cracking or corrosion are found.

4.2.2.3 Strength of Main Vehicle Structure and Securing of Freight

4.2.2.3.1 General

The structural design of wagon shall be carried out in accordance with the requirements of section 3 of EN12663 and the structure shall meet the criteria defined in Clauses 3.4 to 3.6 of this standard.

In addition to the criteria already identified, it is permissible to take the material elongation at failure into account in the selection of the safety factor defined in Clause 3.4.3 of EN12663. Annex ZZ defines how the safety factor and permissible stress shall be determined.

When performing fatigue life assessments it is important to ensure that the load cases are representative of the intended application and expressed in a manner consistent with the adopted design code. Any relevant guidelines on the interpretation of the

 OTIF	ROLLING STOCK FREIGHT WAGONS		UTP WAG Page 25 of 94	
	Status: ADOPTED	Version: 01	Ref.: A 94-02/3.2011	Original: EN

OTIF UTP

Corresponding text in EU regulations

EU ref.

selected design code shall be followed.

The permissible stresses for the materials used in the construction of wagons shall be determined as specified in section 5 of EN12663.

The wagon structure shall be inspected at normal maintenance periods and remedial action taken if signs of significant damage, cracking or corrosion are found.

This section defines the minimum structural requirements for the main load carrying (primary) structure of the wagons and the interfaces with equipment and payload.

These requirements cover:

- Exceptional loads:
 - Longitudinal design loads
 - Maximum vertical load
 - Load combinations
 - Lifting and jacking
 - Equipment attachment (including body/bogie)
 - Other exceptional loads
- Service (fatigue) loads:
 - Sources of load input
 - Payload spectrum
 - Track induced loading
 - Traction and braking
 - Aerodynamic loading
 - Fatigue loads at interfaces
 - Body/bogie connection
 - Equipment attachment
 - Coupler loads
 - Combinations of fatigue loads
- Stiffness of the main vehicle structure
 - Deflection
 - Mode of vibration
 - Torsional stiffness
 - Equipment
- Securing of freight

Measures shall be taken to ensure that the load or parts of the load do not leave the freight wagon or are displaced beyond the boundaries of the wagon accidentally. Requirements for fastening systems or devices such as spigots or securing rings are not mandatory in this UTP.

TSI.

For wagons subject to section 7.6.4, the following requirements also apply:

- only tests and calculations for which numerical simulations have been validated are accepted;

2009/
107/EC
JJ.2, 2.2

 OTIF	ROLLING STOCK FREIGHT WAGONS		UTP WAG Page 26 of 94	
	Status: ADOPTED	Version: 01	Ref.: A 94-02/3.2011	Original: EN

OTIF UTP

Corresponding text in EU regulations

EU ref.

- the maintenance file should take into account the following: the use of thermomechanical rolled steel requires special measures regarding heat treatment.

For other wagons not subject to section 7.6.4, see the note at the beginning of chapter 6.

4.2.2.3.2 Exceptional Loads

4.2.2.3.2.1 Longitudinal Design Loads

Different values will apply for different kinds of freight wagons as identified in EN12663 namely:

- F-I Wagons that may be shunted without restriction;
- F-II Wagons excluded from hump or loose shunting.

The basic structural design requirements assume that wagons in the above categories are fitted with buffers and couplers appropriate to the operations.

The structure shall conform to the requirements of Clause 3.4 of EN12663 when subject to all exceptional load cases.

The wagon bodies shall meet the longitudinal strength requirements as specified in tables 1, 2, 3, and 4 of EN12663 as appropriate, where the load paths exist.

NOTE 1: A force applied to one end of the wagon body shall be reacted at the corresponding position at the opposite end.

NOTE 2: Forces shall be applied horizontally to the mounting structure, divided equally on the axis of each side buffer location or on the axis of the coupler.

NOTE 3: If a buffing test (see Annex Z) is not to be performed, calculations shall be used to demonstrate that the wagon structure is capable of sustaining the maximum buffing loads it is expected to experience in service.

4.2.2.3.2.2 Maximum Vertical Load

The wagon body shall meet the requirements of table 8 of EN12663 modified as indicated in Note 1 below.

The wagon body shall also be designed to carry the anticipated maximum loads due to the method of loading and unloading. It is permissible to define the load cases either in terms of forces or in terms of accelerations applied to the mass being added and to the mass of the body plus any existing payload. The design cases shall represent the most unfavourable cases that the operator wishes to consider associated with the use of the wagon (including foreseeable abuse).

NOTE 1: The factor of 1.3 shall be used instead of 1.95 quoted in table 8 of EN 12663 and note 'a' shall not apply.

NOTE 2: Loads may be distributed uniformly over the full load-carrying surface, over a limited area or at discrete positions. The design case(s) shall be based on the most demanding applications.

NOTE 3: If it is intended that wheeled vehicles (including fork-lift trucks etc.) will operate over the floor of the wagon then the design shall accommodate the maximum local pressure loading associated with such operations.

4.2.2.3.2.3 Load combinations

The structure shall also conform to the requirements of Clause 3.4 of EN12663 when subject to the most adverse load combinations as specified in Clause 4.4 of EN12663.

4.2.2.3.2.4 Lifting and Jacking

The wagon body shall incorporate lifting points by which the whole wagon is capable of being safely lifted or jacked. It shall also be possible to lift one end of the wagon

 OTIF	ROLLING STOCK FREIGHT WAGONS		UTP WAG Page 27 of 94	
	Status: ADOPTED	Version: 01	Ref.: A 94-02/3.2011	Original: EN

OTIF UTP

Corresponding text in EU regulations

EU ref.

(including its running gear) with the other end resting on the remaining running gear.

The load cases specified in Clause 4.3.2 of EN12663 shall apply for lifting and jacking under workshop and servicing operations.

For lifting cases associated only with rescue following derailment or other abnormal incident, where some permanent deformation of the structure is acceptable, it is permissible to reduce the load factor in Tables 9 and 10 from 1.1 to 1.0.

If a factor of 1.0 is used for a validation test, the measured strains shall be extrapolated to demonstrate the conformance to the higher factor.

The lifting shall occur via designated lifting points. The location of the lifting points shall be defined by the customer's operational requirements.

For wagons subject to section 7.6.4, compliance of the jacking with the following diagram is also required.

2009/
107/EC
Annex
JJ.2, 2.3

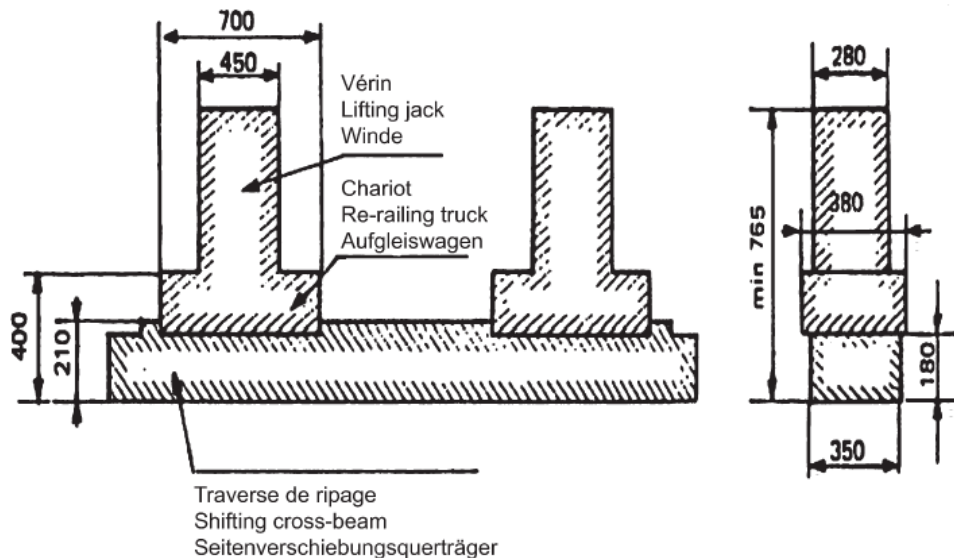

Rerailing / Relevage sur la voie

For other wagons not subject to section 7.6.4, see the note at the beginning of chapter 6.

4.2.2.3.2.5 Equipment Attachment (Including body/bogie)

WAG

The attachments of equipment shall be designed either:

- to carry the loads specified in tables 12, 13 and 14 of section 4.5 of EN12663

Or as an alternative

- to be validated by carrying out an buffing test as described in Annex Z.

4.2.2.3.2.6 Other Exceptional Loads

The load requirements for structural parts of the wagon body, such as side and end wall structures, doors, stanchions and load restraint systems shall be designed to carry the maximum loads they will experience in performing their intended function. The load cases shall be determined using the principles for structural design given in EN12663.

Annex YY provides suitable design requirements for common types of wagon features that are in general use. However they shall be used only where they are applicable.

 OTIF	ROLLING STOCK FREIGHT WAGONS		UTP WAG Page 28 of 94	
	Status: ADOPTED	Version: 01	Ref.: A 94-02/3.2011	Original: EN

OTIF UTP

Corresponding text in EU regulations

EU ref.

For new types of wagon the designer shall determine appropriate load cases to meet the specific requirements using the principles given in EN12663.

4.2.2.3.3 Service (fatigue) Loads

4.2.2.3.3.1 Sources of load input

All sources of cyclic loading that can cause fatigue damage shall be identified. In accordance with Clause 4.6 of EN12663, the inputs listed in Annex N shall be considered and the way in which they are represented and combined shall be consistent with the intended use of the freight wagon. The definition of the load cases shall also be consistent with the material fatigue design code to be used as described in Clause 5.2 and method of validation in Clause 6.3 of EN12663. Where the fatigue load cases act in combination, they shall be taken into account in a manner consistent with the characteristics of the loads and the form of design analysis and fatigue design code being employed.

For most conventional wagon designs the loading defined in Table 16 of EN12663 can be considered as sufficient to represent the full effective combination of fatigue load cycles.

Where detailed data are not available, Annex CC shall be used to determine the main sources of fatigue loading.

4.2.2.3.3.2 Demonstration of fatigue strength

In accordance with Clause 5.2 of EN12663, the behaviour of materials under fatigue loading shall be based on current European Standard, or alternative sources of equivalent standing, wherever such sources are available. Acceptable material fatigue design codes are Eurocode 3 and Eurocode 9 as well as the method described in Annex N.

4.2.2.3.4 Stiffness of the main vehicle structure

4.2.2.3.4.1 Deflections

Deflections under the loads or load combinations shall not be such as to cause the wagon or its payload to exceed the permitted operational envelope (see Annex C and Annex T).

Deflections shall also not impair the functionality of the wagon as a whole or that of any installed components or systems.

4.2.2.3.4.2 Modes of vibration

The design process shall take into account that the natural modes of vibration of the wagon body, in all loading conditions including tare, shall be separated sufficiently, or otherwise de-coupled from the suspension frequencies, so as to avoid the occurrence of undesirable responses at all operating speeds.

4.2.2.3.4.3 Torsional stiffness

The torsional stiffness of the wagon body shall be consistent with the suspension characteristics such that the derailment criteria are achieved in all loading conditions including tare.

4.2.2.3.4.4 Equipment

The natural modes of vibration of equipment, on its mountings, shall be separated sufficiently, or otherwise de-coupled from the wagon body or suspension frequencies, so as to avoid the occurrence of undesirable responses at all operating speeds.

4.2.2.3.4.5 Securing of Freight

Annex YY provides suitable design requirements for common types of features that are in general use. However they shall be used only where they are applicable.

 OTIF	ROLLING STOCK FREIGHT WAGONS		UTP WAG Page 29 of 94	
	Status: ADOPTED	Version: 01	Ref.: A 94-02/3.2011	Original: EN

OTIF UTP

Corresponding text in EU regulations

EU ref.

4.2.2.4 Doors closing and locking

Doors and hatches of freight vehicles shall be designed to be closed and locked.

This remains valid while the vehicles are in a moving train (unless this is part of the procedure for discharging the payload). For this,

Locking devices shall be used which indicate their status (open/closed) and they shall be visible to an operator outside the train.

The locking devices shall be designed to be secured against unintentional opening while the vehicle is running in a train or under shunting. Intentional opening may be part of the procedure for discharging the payload at low speed.

during running.

Closing and locking systems shall be designed so that the operating staffs are not placed at undue risk.

Suitable and clear instructions for use shall be applied near each locking device and shall be visible to the operator.

The closing and locking devices shall be designed to withstand the loads which are caused by the payload under normal, regular conditions and when the payload has been displaced in a foreseeable manner.

The closing and locking devices shall be designed to withstand the loads that occur while the vehicles are passing other trains under all conditions, including when in tunnels.

The forces, which are needed to actuate the closing and locking devices, shall be of a magnitude that can be applied by an operator without additional tools. Exceptions are allowable when additional tools are specifically made available or when motor driven systems are used.

The closing and locking systems shall be inspected at normal maintenance periods and remedial action taken if signs of damage or malfunction are found.

4.2.2.5 Markings and identification

4.2.2.5.1 Marking of freight wagons

Markings are required on wagons to:

- Identify each individual wagon by its unique number, as specified in Annex PP and recorded in the National Vehicle Register (NVR), cf. 4.2.2.5.2 | specified in the Traffic Operations and Management TSI, and recorded in the Register.
- Provide information required to produce train consists including brake mass, length over buffers, tare weight, speed versus load table for different line categories.
- Identify operational restrictions to staff, including geographical limitations, and shunting restrictions.
- Provide pertinent safety information for staff operating wagons or attending in an emergency, including overhead live wire and electrical equipment warning signs, lift / jacking points, vehicle specific safety instructions.

These markings are listed in Annex B and pictograms are included if required.

When EN 15877-1:2012 has entered into force, Annex B will be revised to indicate which parts of the standard will be mandatory in order to fulfil the essential requirements; the affixing of other mark-



OTIF UTP

Corresponding text in EU regulations

EU ref.

ings described in the standard is optional, but if affixed, they shall also comply with the general requirements of the standard.

The markings shall be located as high as practicable on the wagon structure up to a height of 2000 mm | 1600 mm⁸ above rail level. Hazard signs shall be located in such a position that they can be seen before the hazard zone is actually reached. The markings of wagons that do not have vertical sides +/- 10 degrees shall be affixed on special panels.

Markings may be achieved either by painting or by decals.

The requirements for Dangerous Goods Markings are covered by Appendix C (RID) to the Convention. | Directive 96/49/EC⁹ with its valid Annex.

When changes to a wagon occur that require changes to the markings, such changes shall be consistent with changes to the data recorded in the registers. | Rolling Stock Register.

Markings shall be cleaned/replaced when required to ensure that they remain legible.

4.2.2.5.2 Unique vehicle number

TSI OPE
Annex P

One of the markings a wagon must bear shall be a unique vehicle number which shall be registered in the National Vehicle Register of the first admitting Contracting State before a Certificate of Operation is issued.

The specifications for the unique vehicle number will be included in the future Operation and Management UTP (UTP OPE). Until that UTP, which will also include rules for the letter code indicating the characteristics (type) of the wagon, has entered into force, the specifications included in Annex PP and Annex B of this UTP shall apply.

4.2.2.6 Dangerous goods

4.2.2.6.1 General

Wagons carrying dangerous goods shall meet the requirements of this UTP | TSI

and in addition the requirements of RID.

Further developments in this legal area are led by an international working group (RID-Committee) of representatives from the governments which are members of the COTIF.

4.2.2.6.2 Legislation applicable to rolling stock for the transport of dangerous goods

Rolling stock	RID	Council Directive 96/49/EC ⁹ and its Annex in their valid version
---------------	-----	--

⁸ TSI OPE Annex P.2 says 2 m; EN 15877-1:2012 says 2000 mm.

⁹ This Directive has been replaced by Directive 2008/68/EC on the inland transport of dangerous goods

 OTIF	ROLLING STOCK FREIGHT WAGONS		UTP WAG Page 31 of 94	
	Status: ADOPTED	Version: 01	Ref.: A 94-02/3.2011	Original: EN

OTIF UTP

Buffers	RID
Spark protection	RID
Use of wagons for the transport of dangerous goods in long tunnels	-

Corresponding text in EU regulations

EU ref.

Council Directive 96/49/EC and its Annex in their valid version
Council Directive 96/49/EC ⁹ and its Annex in their valid version
Under examination by working groups mandated by the European Commission (AEIF and RID) ¹⁰

4.2.2.6.3 Additional legislation applicable to tanks

Tank	—
Tank testing, inspection and marking	RID

Council Directive 1999/36/EC on transportable pressure equipment (TPED) in its valid version
EN 12972 Tanks for transport of dangerous goods-testing, inspection and marking of metallic tanks from April 2001

4.2.2.6.4 Maintenance rules

The maintenance of tank/freight wagons shall be compliant with the following European Standard and the

RID:

Testing and inspections	RID
Maintenance of tank and its equipment	RID ¹¹
Mutual agreements on tank inspectors	RID

Council Directive:

EN 12972 Tanks for transport of dangerous goods-testing, inspection and marking of metallic tanks from April 2001
Council Directive 96/49/EC and its Annex in their valid version
Council Directive 96/49/EC and its Annex in their valid version

4.2.3 Vehicle track interaction and gauging

4.2.3.1 Kinematic gauge

This section defines the maximum outside dimensions of wagons to ensure that they remain within the infrastructure gauge. To achieve this, the maximum possible movement of the wagon is considered; this is called the kinematic envelope.

The kinematic envelope of the rolling stock is defined by means of a reference profile and its associated rules. It is obtained by applying the rules giving reductions in relation to the reference profile, which the various parts of the rolling stock shall meet.

These reductions depend on:

- the geometric characteristics of the rolling stock in question,
- the position of the cross-section in relation to the bogie pivot or to the axles,
- the height of the point considered in relation to the running surface,
- constructional tolerances,
- the maximum wear allowance,
- the elastic characteristics of the suspension.

The study of the maximum construction gauge takes into account both the lateral and

¹⁰ See also TSI SRT on safety in long railway tunnels

¹¹ See in particular RID 1.4.3.5.

¹² See also EN 15273-2:2009.

 OTIF	ROLLING STOCK FREIGHT WAGONS			UTP WAG Page 32 of 94
	Status: ADOPTED	Version: 01	Ref.: A 94-02/3.2011	Original: EN

OTIF UTP

| Corresponding text in EU regulations

EU ref.

vertical movements of the rolling stock, drawn up on the basis of the geometrical and suspension characteristics of the vehicle under various loading conditions.

The construction gauge of rolling stock travelling on a given section of line shall be smaller, by an appropriate safety margin, than the minimum structure gauge of the line in question.

A rolling stock gauge comprises two fundamental elements: a reference profile and the rules for that profile. It allows determination of the maximum dimensions of rolling stock and the position of fixed structures on the line.

In order that a rolling stock gauge is applicable, the following three parts of that gauge shall be specified:

- the reference profile;
- the rules for determining the maximum construction gauge for the wagons;
- the rules for determining the clearances to structures and the track spacing.

Annex C specifies the reference profile and the rules for the maximum construction gauge for wagons.¹²

The associated rules for determining the clearances for installation of structures are covered in the Infrastructure UTP.

| TSI.

All equipment and parts of wagons that give rise to transverse and vertical displacements shall be checked at appropriate maintenance intervals.

In order to keep the wagon inside the kinematic gauge, the maintenance plan shall include provision for inspection of the following items:

- wheel profile and wear,
- bogie frame,
- springs,
- side bearers,
- body structure,
- constructional clearances,
- maximum wear allowance,
- elastic characteristics of the suspension,
- axle guide wear ,
- elements that affect the vehicle flexibility coefficient,
- elements that affect the roll centre,
- devices causing movements affecting the gauge.

4.2.3.2 Static axle load and linear load

The axle load and axle spacing of the vehicles defines the vertical quasi-static load input to the track.

The load limits for wagons take into account their geometrical characteristics, weights per axle and weights per linear metre.

They shall be in accordance with the classification of lines or sections of lines, categories A, B1, B2, C2, C3, C4, D2, D3, D4 as defined in the table below.

Axle loads higher than 22.5 tonnes are not specified in this UTP;

| TSI;

existing national rules continue to apply to lines capable of accepting these higher axle loads.



OTIF UTP

Corresponding text in EU regulations

EU ref.

Classification	Mass per axle = P						
	A	B	C	D	E	F	G
Mass per unit length = p	16 t	18 t	20 t	22.5 t	25.0 t	27.5 t	30 t
5.0 t/m	A	B1					
6.4 t/m		B2	C2	D2			
7.2 t/m			C3	D3			
8.0 t/m			C4	D4	E4		
8.8 t/m					E5		
10 t/m							

p = Mass per unit length, i.e. the wagon mass plus the mass of the load, divided by the wagon length in metres, measured over the buffers when non-compressed.

P = Mass per axle.

Annex D Table D.1 contains data from which a train made up of wagons with two 2-axle bogies is used in order to determine the category in which a line is classified.

A line or section of line is classified in one of these categories when it is capable of handling an unlimited number of wagons with the weight characteristics shown in the table above.

Classification according to the maximum mass per axle P is expressed in capital letters (A, B, C, D, E, F, G); classification according to the maximum mass per unit length p is expressed in Arabic numerals (1, 2, 3, 4, 5, 6), except for Category A.

The lines thus classified are capable of handling the wagons listed below:

- Two or three-axle wagons, and wagons with 2-axle bogies, where the measurements a and b are equal to or greater than the values shown in Annex D Table D.1, providing P and p do not exceed the values shown in the table above.
- Two 2-axle bogie wagons where the measurements a and b are smaller than the values shown in Annex D Table D.2, providing they have reduced mass per axle, Pr, complying with the values given in Annex D Table D.3 in relation to the values of measurements a and b.
- Two bogie wagons, with 3 or 4 axles per bogie, providing they have reduced mass per axle, Pr, complying with the values given in Annex D Tables D.4 and D.5 in relation to the values of dimensions a and b.
- Wagons with three or four 2-axle bogies provided they have reduced mass per axle, Pr, not exceeding those defined in Annex D Table D.6 in relation to their geometrical characteristics and provided that they also comply with the special regulations governing these types of wagon.

NOTE: As an exception for 20 t axle-loads it is permissible to exceed this limit by up to 0.5 t per axle on Category C lines for:

- 2-axle long wagons with $14.10 \text{ m} < \text{LOB (length over buffers)} < 15.50 \text{ m}$ to bring their payload up to 25 t ;
- wagons designed for 22.5 t axle-loads to offset the extra tare incurred in making them suitable for such axle-loads.

Wagons having irregular axle spacings not conforming with Annex D sections D .3, D.4, D.5) shall be subject to additional checks by calculation, to ensure that the maximum bending moments and shear forces on a single beam of any span length do not exceed the values calculated for the wagons defined in Annex D section D.1). This shall be applied to an unlimited number of wagons.

 OTIF	ROLLING STOCK FREIGHT WAGONS		UTP WAG Page 34 of 94	
	Status: ADOPTED	Version: 01	Ref.: A 94-02/3.2011	Original: EN

OTIF UTP

| Corresponding text in EU regulations

EU ref.

The maximum payload that can be carried by a wagon, from the point of view of track and structures, is the lowest value resulting from the following formulae:

$$X = n \times P - T$$

$$Y = L \times p - T$$

$$Z = n \times Pr - T$$

where:

n: number of axles of the wagon

p: mass per unit length in t/m

L: length over buffers in m

T: wagon tare in t, rounded up to the first decimal place

P: mass per axle in t

Pr: reduced mass per axle in t

The tare to be taken into account is the average tare, which shall be determined for the following groups of wagons within each major manufacturing series:

- wagons with air brakes,
- wagons with air brakes and a gangway fitted with a screw brake.

The limits for modifications of freight wagons not requiring new approval are listed in Annex II.

Annex D sections D.6 and D.7 give the load limits for 2-axle wagons and the most common types of two 2-axle bogie wagons (a = 1.80 m, b = 1.50 m (see definition in Annex D)) resulting from comparisons.

The value X, Y or Z selected on the basis of the comparison is rounded down either to the nearest half-tonne or to the nearest tenth of a tonne, each applicant | contracting entity being free to select either of these alternatives depending on the type of wagon.

However, for insulated, refrigerator or mechanically-refrigerated wagons, tank wagons and closed wagons used for carrying goods in powder form, the X, Y or Z value shall be rounded down to the nearest tenth of a tonne.

The value to be marked on the wagon is not necessarily that established above. In cases where lower load limits exist as a result of the structural characteristics of the wagon (Annex D section D.3) or RID regulations, it is these lower values that shall be indicated.

Minimum wheelset load for wagons with:

Generally with two axles or more	5.0 t
4-axle and equipped with brake blocks	4.0 t
Greater than 4-axle and equipped with brake blocks	3.5 t
If permitted according to the infrastructure register (e.g. specific case of "the Rolling Road")	
8-axles	2.0 t
12-axles	1.3 t

4.2.3.3 Rolling stock parameters which influence ground based train monitoring systems

4.2.3.3.1 Electrical resistance

The electrical resistance of each wheelset measured across the treads of the two wheels shall not exceed 0.01 ohm for new or reassembled wheelsets incorporating new components.

These resistance measurements are to be made using an applied voltage of 1.8 to 2.0 volts DC.

 OTIF	ROLLING STOCK FREIGHT WAGONS		UTP WAG Page 35 of 94	
	Status: ADOPTED	Version: 01	Ref.: A 94-02/3.2011	Original: EN

<i>OTIF UTP</i>	<i>Corresponding text in EU regulations</i>	<i>EU ref.</i>
4.2.3.3.2 Hot axle box detection		2009/ 107/EC 6)
For wagons subject to section 7.6.4, Annex LL applies. For wagons <u>not</u> subject to section 7.6.4, this is an open point, cf. Annex JJ.	the open point identified in section 4.2.3.3.2 of this TSI is closed if the wagon complies with the specifications of the related ERA Technical Document. For other wagons this remains an open point.	
4.2.3.3.3 Electric or electromagnetic interference		2009/ 107/EC JJ.2, 2.9
Wagons subject to section 7.6.4, and fitted with a source of energy which may cause electrical interference must be examined against leaflets UIC 550-2 and 550-3. The electromagnetic signature of maximum train compositions must be validated. For other wagons <u>not</u> subject to section 7.6.4, see the note at the beginning of chapter 6.		
4.2.3.4 Vehicle dynamic behaviour		2009/ 107/EC JJ.2, 2.5
For wagons subject to section 7.6.4: For bogies not listed in annex Y, the standard EN 14363 or leaflet UIC 432 apply.		
4.2.3.4.1 General		WAG
The dynamic behaviour of a vehicle has strong effects on safety against derailment and running stability. The vehicle dynamic behaviour is determined by		
<ul style="list-style-type: none"> • the maximum speed • static track features (alignment, track gauge, cant, rail inclination, discrete and periodic track irregularities) • dynamic track features (horizontal and vertical track stiffness and track damping) • wheel/rail contact parameters (Wheel and rail profile, track gauge) • wheel defects (wheel flats, out of roundness) • mass and inertia of car body, bogies and wheelsets • suspension characteristic of the vehicles • distribution of the payload. 		
In order to ensure safety and running stability, measurements in different operating conditions or comparison studies with a proven design (e. g. simulation/calculation) have to be carried out to assess the dynamic behaviour.		
Rolling stock shall have characteristics that enable stable running within the applicable speed limit.		
4.2.3.4.2 Functional and technical specifications		
4.2.3.4.2.1 Safety against derailment and running stability		
In order to ensure safety against derailment and running stability the forces between wheel and rail have to be limited. In particular, the forces in question are transverse track forces Y and vertical forces Q.		
— Lateral track force Y		
Prud'homme criteria for the maximum transverse force (ΣY) _{lim} = $\alpha (10 + P / 3)$, where $\alpha = 0.85$ and P = maximum static axle load or (H _{2m}) _{lim} where (H _{2m}) is the floating mean value of the lateral force in an axle measured over 2 m.		
This value will be determined by the		

 OTIF	ROLLING STOCK FREIGHT WAGONS			UTP WAG Page 36 of 94
	Status: ADOPTED	Version: 01	Ref.: A 94-02/3.2011	Original: EN

OTIF UTP

UTP Infrastructure.

Corresponding text in EU regulations

EU ref.

TSI Infrastructure.

In curves, the limit of the quasi-static lateral force on the outer wheel is $Y_{qst,lim}$

This value will be determined by the
UTP Infrastructure.

TSI Infrastructure.

— Y/Q forces

To limit the risk of wheel climb on the rail the quotient of lateral force Y and vertical load Q of a wheel shall not exceed

$(Y/Q)_{lim} = 0.8$ for dynamic on-track tests

$(Y/Q)_{lim} = 1.2$ for stationary tests

— Vertical forces

The maximum dynamic vertical force exerted on the rail is Q_{max}

This value will be determined by the
UTP Infrastructure.

TSI Infrastructure.

In curves the limit of the quasi-static vertical force on the outer wheel is $Q_{qst,lim}$

This value will be determined by the
UTP Infrastructure.

TSI Infrastructure.

4.2.3.4.2.2 Safety against derailment when running on twisted tracks

Wagons are able to run on twisted tracks when (Y/Q) for stationary tests does not exceed the limit given in section 4.2.3.4.2.1 in a curve of radius $R = 150$ m and for a given twisted track:

for a wheel base of $1.3 \text{ m} \leq 2a^*$

- $g_{lim} = 7\text{‰}$ for $2a^+ < 4$ m
- $g_{lim} = 20/2a^+ + 2$ for $2a^+ > 4$ m
- $g_{lim} = 20/2a^* + 2$ for $2a^* < 20$ m
- $g_{lim} = 3\text{‰}$ for $2a^* > 20$ m

The wheelbase $2a^*$ represents the axle spacing for 2-axle wagons or the distance between the pivot centres of a bogie wagon. The wheelbase $2a^+$ represents the axle spacing for a bogie.

For wagons subject to section 7.6.4:

- One of the three methods given in EN 14363 shall be applied;
- Freight wagons are exempted from these tests if they comply with the requirements of UIC leaflet 530-2.

2009/
107/EC
JJ.2, 2.5

4.2.3.4.2.3 Maintenance rules

WAG

The following key parameters essential for safety and running stability shall be maintained according to the maintenance plan:

- suspension characteristics
- body-bogie connections
- tread profile

The maximum and minimum dimensions for wheelsets and wheels for Standard Gauge (1435 mm) are given in Annex E.

Cases for other track gauges are to be found in section 7.

 OTIF	ROLLING STOCK FREIGHT WAGONS		UTP WAG Page 37 of 94	
	Status: ADOPTED	Version: 01	Ref.: A 94-02/3.2011	Original: EN

OTIF UTP

Corresponding text in EU regulations

EU ref.

4.2.3.4.2.4 Suspension

Suspension of freight wagons shall be designed such that the values specified in 4.2.2.1.2.2 and 4.2.2.1.2.3 are adhered to in the conditions "empty" and "laden to the load limit". The suspension calculation shall demonstrate that the suspension deflection is not exhausted when the wagons are fully loaded and considering dynamic influences.

For wagons subject to section 7.6.4, the application of UIC leaflet 517 is mandatory for the calculation of the suspension of two-axle wagons. 2009/
107/EC
JJ.2, 2.8

For other wagons not subject to section 7.6.4, see the note at the beginning of chapter 6.

4.2.3.5 Longitudinal compressive forces

4.2.3.5.1 General

WAG

This parameter describes the maximum longitudinal compressive forces that can be applied on an interoperable freight wagon or an individual vehicle, or group of special coupled vehicles, of an interoperable train-set during a braking or a banking operation, without any risk of derailment.

When subjected to Longitudinal Compressive Forces (LCF), the wagon shall continue to run safely. In order to ensure safety against derailment, the wagon or system of coupled wagons shall be assessed by tests, calculations or through comparison with the characteristics of already approved (certified) wagons.

The longitudinal force that can be applied on a vehicle without derailing shall be higher than a threshold value depending on the vehicle design (two axle, bogie wagon, fixed group of vehicles, Combirail, Road- Railer™, etc.) fitted with UIC coupler or accepted central coupler or coupling rod/short couplers.

The conditions to certify the wagons, fixed groups of wagons and coupled groups of wagons are given in section 4.2.3.5.2.

The conditions that affect the maximum longitudinal compressive force that a wagon is capable of withstanding without derailment include:

- cant deficiency
- train and wagon braking system
- system of draw gear and buffers on the wagons or specially coupled wagon-groups
- design characteristics of the wagon
- characteristics of the line
- train driver's handling of the train, especially braking
- wheel/rail contact parameters (wheel and rail profile, track gauge)
- load distribution of the individual freight wagons.

Longitudinal compressive forces have a strong effect on safety against derailment of a vehicle. Therefore measurements in different operating conditions have been carried out to find the acceptable limits of longitudinal compressive force that can be applied on a vehicle without risk of derailment. To avoid testing wagons shall correspond with the characteristics of wagons that have been previously approved by national safety authorities or on their behalf, or to be built according to approved design characteristics of wagons and be fitted with approved components such as certified bogies.

The reference test is given in section 6.2. Experience with different wagon-types has resulted in different methods of acceptance depending on factors such as tare weight, length, wheelbase, overhang, distance between pivots etc.

 OTIF	ROLLING STOCK FREIGHT WAGONS		UTP WAG Page 38 of 94	
	Status: ADOPTED	Version: 01	Ref.: A 94-02/3.2011	Original: EN

OTIF UTP

| Corresponding text in EU regulations

EU ref.

4.2.3.5.2 Functional and technical specifications

The subsystem shall withstand the longitudinal compressive forces in the train without derailing or damaging the vehicle. In particular the determining factors are

- transverse wheel/rail forces -Y-
- vertical forces -Q-
- lateral forces on axle-boxes -H_{ij}-
- braking forces (due to wheel/rail contact, dynamic braking and different braking groups of the wagons and trains)
- diagonal and vertical buffer forces
- coupling forces ± Z
- damping of buffer- and coupling forces
- the result of coupler tightness
- the result of coupler slack
- jerks as a result of longitudinal movements in the trains and
- coupler slack
- wheel lift
- axle guide deflection.

For wagons subject to section 7.6.4, in addition to the specifications in this section and in section 4.2.3.5.1 and Annex R of this UTP,

2009/
107/EC
JJ.2, 2.6

TSI, compliance with section 3.2 of UIC leaflet 530-2 is also required, except for the requirements to communicate with and to receive the agreement from the UIC Study Group (SG) 2.

For other wagons not subject to section 7.6.4, see the note at the beginning of chapter 6.

Longitudinal Compressive Forces (LCF) are influenced by many factors. The different WAG factors are given in the documents for construction and operating conditions of wagons to which it is necessary to certify wagons for normal traffic on different lines and under different conditions.

With the objective to certify wagons for mixed traffic within the geographical scope of this UTP, | on the European Network, tests on a special testing track, and in running trains on different lines were performed in order to ensure that wagons can withstand a minimum longitudinal force, without derailing. The following definition was made:

Wagons and rakes of wagons (with coupling rod/short coupler between the wagons) fitted with screw couplings and side-buffers at their outer ends, shall withstand a minimum longitudinal force measured in the conditions of the reference test of:

- 200 kN for two-axle freight wagons with UIC coupling
- 240 kN for freight wagons fitted with two-axle bogies with UIC coupling
- 500 kN for freight wagons with all types of central bar couplers and without buffers

For other coupling systems, limit values are not yet defined.

The coefficient of friction of the buffer heads shall be such as to meet the requirements of this

UTP Infrastructure

| TSI Infrastructure.

in terms of maximum lateral forces.

 OTIF	ROLLING STOCK FREIGHT WAGONS		UTP WAG Page 39 of 94	
	Status: ADOPTED	Version: 01	Ref.: A 94-02/3.2011	Original: EN

OTIF UTP

| Corresponding text in EU regulations

EU ref.

Maintenance rules:

If the buffer heads have to be lubricated in order to ensure the required coefficient of friction, then the maintenance plan shall include provision for maintaining the coefficient of friction at this level.

4.2.4 Braking

4.2.4.1 Braking performance

4.2.4.1.1 General

The purpose of the train braking system is to ensure that the train's speed can be reduced or it can be stopped within the maximum allowable braking distance. The primary factors that influence the brake process are the braking power, the train mass, the speed, the allowable braking distance, the adhesion and the track gradient.

Braking performance of a train or a vehicle is the result of the braking power available to retard the train within defined limits and all factors involved in the conversion and dissipation of energy including train resistance. Individual vehicle performance is defined so that the overall braking performance of the train can be derived.

Vehicles shall be equipped with continuous automatic brake.

A brake is continuous if it allows the transmission of signals and energy from central command unit to the whole train.

A continuous brake is automatic, if it becomes effective immediately on the whole train with every inadvertent break of the control train line, e. g. brake-pipe.

Where it is not possible to detect the state of the brake, an indicator showing the state shall be provided on both sides of the vehicle.

The brake energy storage (e.g. supply reservoirs of indirect pneumatic air brake system, brake pipe air) and the brake energy used to build up the brake effort (e.g. air from brake Cylinders of indirect pneumatic air brake system) shall be used only for braking use.

4.2.4.1.2 Functional and Technical Specification

4.2.4.1.2.1 Control train line

The minimum propagation braking signal speed shall be 250 m/s.

4.2.4.1.2.2 Braking Performance elements

Braking performance shall take into account mean application time, instantaneous deceleration, mass and initial speed. Braking performance shall be determined by both deceleration profiles and by braked mass percentage.

Deceleration profile:

The deceleration profile describes the predicted instantaneous deceleration of the vehicle (at the level of a vehicle) or the train (at the level of a train) in normal conditions.

Knowledge of individual vehicle deceleration profiles enables the calculation of the overall train deceleration profile.

The deceleration profile includes the effect of:

- a) the response time between brake demand and reaching full brake effort.



OTIF UTP

Corresponding text in EU regulations

EU ref.

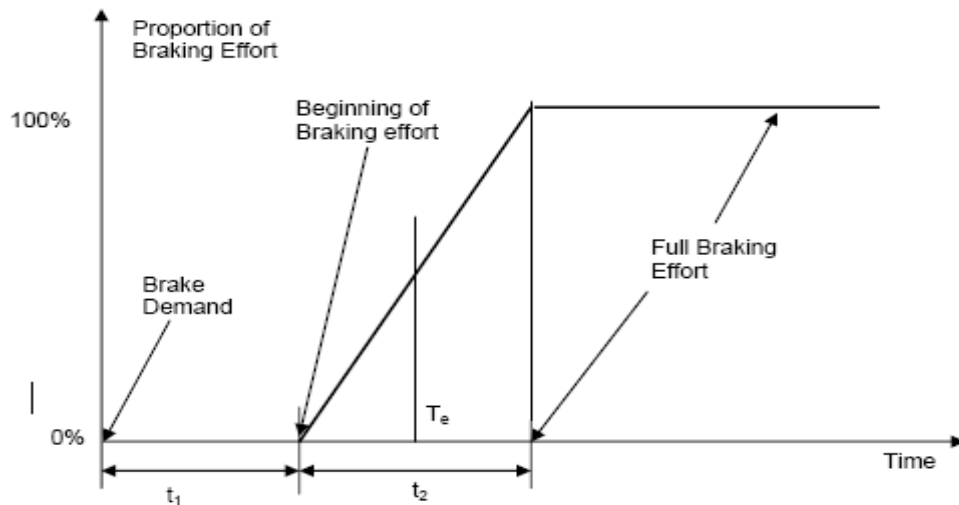

T_e is the equivalent build-up application time and is defined as:

$$T_e = t_1 + (t_2 / 2)$$

For pneumatic brake the end of the time t_2 corresponds to 95 % of established brake cylinder pressure.

- b) the corresponding function (deceleration = F(speed)) as defined as a succession of sections with a constant deceleration.

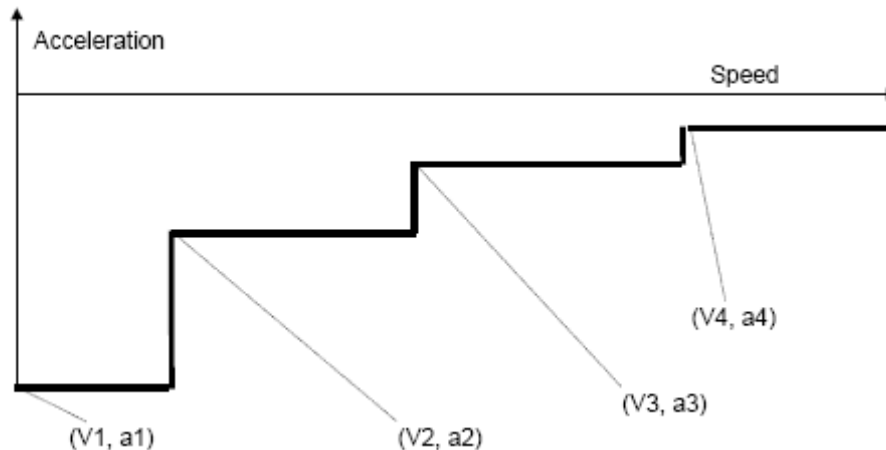

Note: a denotes the instantaneous deceleration and V the instantaneous speed

Brake mass percentage:

The brake mass percentage (λ) is the ratio of the sum of the brake masses divided by the sum of the masses of the vehicles.

The method of determining the brake mass / brake mass percentage shall remain applicable in addition to the method of deceleration profiles; the manufacturer shall supply these values. This information is required to be entered in the OTIF Register of admitted types of vehicles. [Rolling Stock Register.

Braking power for an individual vehicle shall be determined in emergency braking for each braking mode (i.e. G, P, R, P + ep) available on the vehicle and for several loading conditions including at least tare and fully loaded.

G braking mode: brake mode used for freight trains with specified brake application time and brake release time.

P braking mode: brake mode for freight trains with specified brake application time

 OTIF	ROLLING STOCK FREIGHT WAGONS			UTP WAG Page 41 of 94
	Status: ADOPTED	Version: 01	Ref.: A 94-02/3.2011	Original: EN

OTIF UTP

Corresponding text in EU regulations

EU ref.

and brake release time and specified brake mass percentage.

R braking mode: brake mode for passenger trains and fast freight trains with specified brake application time and brake release time as for braking mode P and specified minimum brake mass percentage.

Ep brake (indirect Electro-pneumatic brake): assistance to indirect air brake that uses an electrical command on the train and electro-pneumatic valves on the vehicle and thus starts operating more rapidly and less jerkily than the conventional air brake.

Emergency braking: Emergency braking is a brake command that stops the train to ensure the specified level of safety without any brake system degradation.

The minimum braking performance for brake-modes G and P: shall be in accordance with the following table:

 OTIF	ROLLING STOCK FREIGHT WAGONS			UTP WAG Page 42 of 94
	Status: ADOPTED	Version: 01	Ref.: A 94-02/3.2011	Original: EN

Braking Mode - T _e range (s)	Wagon type	Command equipment	Load	Requirement for running speed at 100km/h		Requirement for running speed at 120km/h	
				Maxi	Mini	Maxi	Mini
Braking mode "P" - 1.5 ≤ T _e ≤ 3s	All	All	Empty	S=480m $\lambda=100\%$ (1) $\gamma=0.91\text{m/s}^2$ (1)	Case A - composite blocks : S=390m , $\lambda=125\%$, $\gamma=1.15\text{m/s}^2$ Case B – other cases: S=380m , $\lambda=130\%$, $\gamma= 1.18\text{m/s}^2$	S=700 m $\lambda=100\%$ $\gamma=0.88\text{m/s}^2$	Case A – composite blocks : S=580m , $\lambda=125\%$, $\gamma=1.08\text{m/s}^2$ Case B – other cases: S=560m , $\lambda=130\%$, $\gamma=1.13\text{m/s}^2$
	"S1" (2)	Empty/ Load device	Intermediate Load	S=810m $\lambda=55\%$ $\gamma=0.51\text{m/s}^2$	Case A - composite blocks : S=390m , $\lambda=125\%$, $\gamma=1.15\text{m/s}^2$ Case B – other cases: S=380m , $\lambda=130\%$, $\gamma= 1.18\text{m/s}^2$		
			LOADED (Maximum =22.5t/axle)	S=700m $\lambda=65\%$ $\gamma=0.60\text{m/s}^2$	Case A - Brake only on wheels (Brake blocks) : S= greater of (S=480m , $\lambda=100\%$, $\gamma=0.91\text{m/s}^2$) or (S obtained with a mean retardation force of 16.5 kN per axle (5)). Case B – Other cases: S=480m , $\lambda=100\%$, $\gamma=0.91\text{m/s}^2$		
	"S2" (3)	Variable load Relay	LOADED (Maximum =22.5t/axle)	S=700m $\lambda=65\%$ $\gamma=0.60\text{m/s}^2$	Case A - Brake only on wheels (Brake blocks) : S= greater of (S=480m , $\lambda=100\%$, $\gamma=0.91\text{m/s}^2$) or (S obtained with a mean retardation force of 16.5 kN per axle (5)). Case B – Other cases: S=480m , $\lambda=100\%$, $\gamma=0.91\text{m/s}^2$		
	"SS" (4)	Variable load Relay	LOADED (Maximum =22.5t/axle)			Case A - Brake only on wheels (Brake blocks) : S= greater of (S=700m , $\lambda=100\%$, $\gamma=0.88\text{m/s}^2$) or (S obtained with a mean retardation force of 16 kN per axle (6)). Case B – Other cases: S=700m , $\lambda=100\%$, $\gamma=0.88\text{m/s}^2$	
Braking mode "G" - 9 ≤ T _e ≤ 15s				There shall be no separate assessment of the braking power of wagons in position G. A wagon's braked mass in position G shall be the same as braked mass in position P			

 OTIF	ROLLING STOCK FREIGHT WAGONS		UTP WAG Page 43 of 94	
	Status: ADOPTED	Version: 01	Ref.: A 94-02/3.2011	Original: EN

OTIF UTP

| Corresponding text in EU regulations

EU ref.

- (1) S is obtained according annex S, " λ " = $((C/S)-D)$ according annex S, " γ " = $((\text{Speed (km/h)}/3.6)^2) / (2 \times (S - (T_e) \times (\text{Speed (km/h)}/3.6)))$, with $T_e=2$ sec.
- (2) a wagon "S1" is a wagon with Empty/Load device
- (3) a wagon "S2" is a wagon with a variable load relay
- (4) a wagon "SS" shall be equipped with a variable load relay.
- (5) The maximum mean retardation force admitted (for running speed at 100 km/h) is $18 \times 0.91 = 16.5$ kN/axle. This value comes from the maximum braking energy input permitted on a clasp braked wheel with a nominal new diameter in the range of [920 mm ; 1000 mm] during braking (the brake mass shall be limited to 18 tonnes). Wheels with a nominal new diameter (< 920 mm) and/or push brakes shall be accepted in accordance with national rules.
- (6) The maximum mean retardation force admitted (for running speed at 120 km/h) is $18 \times 0.88 = 16$ kN/axle. This value comes from the maximum braking energy input permitted on a clasp braked wheel with a nominal new diameter in the range of [920 mm ; 1000 mm] during braking (the brake mass shall be limited to 18 tonnes). Wheels with a nominal new diameter (< 920 mm) and/or push brakes shall be accepted in accordance with national rules.

This table is based on a reference speed of 100 km/h and an axle load of 22.5 t and 120 km/h and an axle load of 22.5 t. Higher axle loads can be accepted under specific operational conditions in accordance with national rules. The permitted maximum axle load shall be in accordance with the infrastructure requirements.

If a wagon is equipped with a "Wheel Slip Protection" (WSP), the above performance shall be achieved without activation of the WSP and according to the conditions in annex S.

Other braking modes (example: R braking mode) are permitted according to national rules and the mandatory use of WSP as specified in section 4.2.4.1.2.6.

Brake Pipe Emptying Accelerator valve

If the brake pipe-emptying accelerator is separately installed on the wagon, it shall be capable of isolation from the brake pipe by a specific device. The wagon shall be clearly marked to indicate this isolation device, or this device shall be secured in an "open" position by a seal.

4.2.4.1.2.3 Mechanical components

The assembly of brake components shall be aimed to prevent any partial or full detachment of these components.

- **Slack adjuster**

A device to automatically maintain the design clearance between the friction pair shall be provided.

A minimum of 15 mm clearance between the slack adjuster envelope and other components shall be provided.

Provision shall be made for the necessary free clearances for the slack adjuster extremities and connections to be maintained at all times.

For slack adjusters within a bogie, there is no special envelope. But, for all design conditions, the minimum clearance necessary between the slack adjuster and other components shall be ensured to prevent contact. Should a smaller clearance be required, the reasons why contact will not occur shall be demonstrated.

- **Pneumatic half coupling**

The opening of the automatic air brake coupling head shall face the left when looking at the end of the vehicle. The opening of the main reservoir coupling head shall face the right when looking at the end of the vehicle.

 OTIF	ROLLING STOCK FREIGHT WAGONS		UTP WAG Page 44 of 94	
	Status: ADOPTED	Version: 01	Ref.: A 94-02/3.2011	Original: EN

OTIF UTP

| Corresponding text in EU regulations

EU ref.

The vehicles shall be fitted with devices to enable the unused couplings to be suspended at least 140 mm above rail level to prevent both damage and, as far possible, penetration of foreign bodies into the interior coupling.

4.2.4.1.2.4 Energy storage

The energy storage shall be sufficient to obtain during an emergency braking at maximum speed, whatever the loaded state of the vehicle, the maximum brake effort without any further supply of energy (e.g. for indirect compressed air brake system: Brake Pipe only without replenishment by main reservoir pipe). When a vehicle is equipped with WSP the above condition applies with the WSP fully operational (i.e. WSP air consumption).

For wagons subject to section 7.6.4, the energy storage has to be designed in such a way that after a brake application (with the maximum brake cylinder pressure and maximum possible cylinder output stroke of the wagon at any load state) the pressure in the auxiliary reservoir must be at least 0.3 bar more than the brake cylinder pressure without the addition of any further energy.

2009/
107/EC
JJ.2,
2.7.1

For other wagons not subject to section 7.6.4, see the note at the beginning of chapter 6.

4.2.4.1.2.5 Energy limits

The brake system shall be designed to allow the vehicle to run on all existing lines of the trans-European conventional rail system.

The brake system shall stop the vehicle loaded and maintain the speed of the vehicle without any thermal or mechanical damage in the following conditions:

1. Two successive emergency braking applications from the maximum speed to a stop on straight and level track with minimum wind and dry rail.
2. Maintain a speed of 80 km/h in a slope with a mean declivity of 21 ‰ and a length of 46 km. (The south slope of St Gothard's line between Airolo and Biasca is the reference slope.)

4.2.4.1.2.6 Wheel slide protection (WSP)

Wheel slide protection (WSP) is a system designed to make the best use of available adhesion by a controlled reduction and restoration of the brake force to prevent wheelsets from locking and uncontrolled sliding, thereby optimising stopping distance. The WSP shall not alter the functional characteristics of the brakes. The vehicle's air equipment shall be dimensioned such that the air consumption of the WSP does not impair the performance of the pneumatic brake. The design process of the WSP shall take into account that the WSP shall not have a detrimental effect on the constituent parts of the vehicle (brake gear, wheel tread, axle boxes, etc).

The following types of wagons shall be fitted with WSP:

- a) equipped with brake blocks made of cast iron or sintered material, for which the maximum mean utilisation of adhesion (δ) is greater than 12 % ($\Lambda \geq 135$ %). The maximum mean utilisation of adhesion is shown by calculating the mean adhesion (δ) from individual braking distances obtained from the possible range of vehicle mass. δ is therefore related to the measured braking distances necessary for determining the braking performance. ($\delta = f(V, T_e, \text{Stopping distance})$).
- b) equipped with disc brakes only, for which the maximum utilisation of adhesion (see above for the definition of the maximum utilisation of adhesion (δ)) is greater than 11 % and less than 12 % ($125 < \Lambda \leq 135$ %).
- c) With maximum operating speed ≥ 160 km/h.

 OTIF	ROLLING STOCK FREIGHT WAGONS			UTP WAG Page 45 of 94
	Status: ADOPTED	Version: 01	Ref.: A 94-02/3.2011	Original: EN

OTIF UTP

| Corresponding text in EU regulations

EU ref.

4.2.4.1.2.7 Air-supply

Freight wagons shall be designed to be able to work with compressed air compliant at least with class 4.4.5 as defined by ISO 8573-1.

4.2.4.1.2.8 Parking Brake

A Parking Brake is a brake used to prevent parked rolling stock moving under the specified conditions taking into account the place, wind, gradient and rolling stock loading state, until intentionally released.

It is not compulsory for all wagons to be equipped with a parking brake. Operational rules, taking into account the fact that not all wagons in a train are equipped with these brakes, are described in the UTP Operation.

| Traffic operation and management TSI.

If the wagon is equipped with a parking brake, it shall meet the following requirements.

The power source for providing the parking brake effort shall be derived from a different power source than the Automatic Service/Emergency brake.

The parking brake shall operate on at least half of the wheelsets, with a minimum of 2 wheelsets per wagon.

Where it is not possible to see the state of the parking brake, an indicator showing the state shall be provided on both sides on the outside of the vehicle.

The wagon parking brake shall be accessed and operated from the ground or on the vehicle. Handles or hand wheels shall be used to operate the parking brake, but only hand wheels may be used for brakes operated from the ground. Parking brakes that are accessible from the ground shall be available on both sides of the vehicle. Handles or hand wheels shall apply the brakes when they are turned in a clockwise direction.

Where the parking brake controls are fitted inside a vehicle, they shall be accessible from both sides of the vehicle. Where the parking brake can be superimposed with other brake applications, either whilst moving or statically, the vehicle equipment shall be able to withstand the imposed loads for the life of the vehicle.

It shall be possible to release the parking brake manually in an emergency situation at standstill.

The parking brake shall conform to the table below:

See footnote ¹³

| For wagons not specifically listed in the table below:

At least 20 % of a fleet of wagons shall have a parking brake operated from the wagon (platform or gang-way) or the ground.

Wagons built specifically for the transport of loads requiring precautions as follows and/or according to RID: livestock; fragile loads; compressed or liquefied gases; materials which emit flammable gases when in contact with water, causing combustion; acids; corrosive or combustible liquids; loads which may ignite spontaneously, catch fire or explode easily.	One per wagon operated from the vehicle (platform or gangway).
Wagons whose special fittings for accommo-	One per wagon operated from the

¹³ Fleet is not defined, therefore no requirements are set out in the UTP for wagons not listed in the table; this requirement cannot be checked by the admission of the individual wagons.

 OTIF	ROLLING STOCK FREIGHT WAGONS		UTP WAG Page 46 of 94	
	Status: ADOPTED	Version: 01	Ref.: A 94-02/3.2011	Original: EN

OTIF UTP

Corresponding text in EU regulations

EU ref.

dating the load shall be treated with caution, i.e. carboy, jar or cask wagons; tanks made of aluminium; tanks lined with ebonite or enamel; crane wagons, (and/or according to RID).	wagon (platform or gangway).
Wagons with a superstructure built specifically for the transport of road vehicles, including multi-deck wagons for the transport of motor cars.	One per wagon operated from the wagon (platform or gangway) and 20 % of these having the parking brake also operated from the wagon floor.
Wagons for the transport of demountable swap bodies for horizontal transshipment.	One per wagon operated from the ground.
Wagons comprising several permanently coupled units.	A minimum of two axles (on one unit).

See footnote ¹⁴

- the minimum parking brake performance, assuming no wind, shall be determined by calculations as defined in clause 6 of EN 14531-6:2009.
- the minimum performance of the parking brake shall be marked on the unit. The marking shall comply with clause 4.2.25 of EN 15877-1:2012. The parking brake of a unit shall be designed assuming a wheel/rail (steel/steel) adhesion factor not greater than 0.12.

The parking brake shall be designed such that fully loaded wagons shall be held in a gradient of 4.0 % with maximum adhesion of 0.15 with no wind.

4.2.5 COMMUNICATION

4.2.5.1 Vehicle capability to transmit information from vehicle to vehicle

This parameter is not yet applicable for freight wagons.

4.2.5.2 Vehicle capability to transmit information between ground and vehicle

4.2.5.2.1 General

Application of tags is not mandatory. If a wagon is fitted with radio-frequency identification devices (RFID-tag), the following specification shall be applied.

4.2.5.2.2 Functional and technical specification

Two "passive" tags shall be fitted, one on each side of the wagon in the areas indicated in Annex F figure F.1, such that the unique identification number of the wagon can be read by a trackside device (the *tag reader*).

When available, trackside devices (*tag reader*) shall be capable of decoding tags passing at a speed of up to 30 km/h and make this decoded information available to a groundbased data transmission system.

Typical installation constraints are given in the Annex F figure F.2 where the reader position is defined by a cone.

The physical interactions between the reader and the tag, the protocols and the commands, and the collision arbitration schemes, shall conform to ISO18000-6 type A.

¹⁴ This text is included in clause 4.2.4.3.2.2 Parking brake of the final draft (version 0.2) of the revised TSI WAG. A similar text is part of the "Omnibus after WP32, dated May 2011" concerning correction of errors in the TSI WAG in force.

 OTIF	ROLLING STOCK FREIGHT WAGONS		UTP WAG Page 47 of 94	
	Status: ADOPTED	Version: 01	Ref.: A 94-02/3.2011	Original: EN

OTIF UTP

| Corresponding text in EU regulations

EU ref.

When fitted, tag readers shall be positioned at entry and exit points of locations where train formation can be changed.

The tag reader shall provide at a minimum to the interface with any data transmission system the following:

- Unambiguous identification of the tag reader, among those that may be installed in the same location, in order to identify the track being monitored,
- Unique identification of every wagon passing,
- Time and date for each wagon passing.

Time and date information shall be accurate enough in order that a subsequent processing system is able to identify the actual physical train composition.

4.2.5.2.3 Maintenance rules

Inspections according to the maintenance plan shall include:

- presence of tags,
- correct response,
- processes to ensure that tags will not be degraded during the maintenance procedures.

4.2.6 Environmental conditions

4.2.6.1 Environmental conditions

4.2.6.1.1 General

The design process of the rolling stock, as well as the on-board equipment, shall take into account that this rolling stock shall be able to be put into service and operate normally in the conditions and climatic zones for which the equipment is designed and in which it is likely to run, as specified in this UTP. | TSI.

The environmental conditions are expressed in classes for temperature etc. thereby giving the choice for the operator to procure a vehicle suitable for operation all over the territory of the Contracting States, | Europe, or have a restricted use.

The 'Register of Infrastructure' will specify the ranges of environmental conditions likely to be experienced on the individual lines. The same ranges will be used to assist reference to operating rules.

The range limits specified are those which have a low probability of being exceeded. All specified values are maximum or limit values. These values may be reached, but do not occur permanently. Depending on the situation there may be different frequencies of occurrence related to a certain period of time.

4.2.6.1.2 Functional and technical specifications

4.2.6.1.2.1 Altitude

The wagons shall perform as specified for all altitudes up to 2000 m.

4.2.6.1.2.2 Temperature

All freight wagons intended for international traffic shall comply as a minimum with temperature class T_{RIV} .

The class T_{RIV} is identical to the temperature design level of all RIV compliant wagons existing before implementation of this UTP | TSI

In addition to design level class T_{RIV} the external temperature classes T_s and T_n

 OTIF	ROLLING STOCK FREIGHT WAGONS		UTP WAG Page 48 of 94	
	Status: ADOPTED	Version: 01	Ref.: A 94-02/3.2011	Original: EN

OTIF UTP

| Corresponding text in EU regulations

EU ref.

exists.

Classes	Design level classes
TRIV	Subsystems and components have different temperature requirements. Details are given in Annex O
	Air temperature range external to vehicle [°C]:
Tn	- 40 to + 35
Ts	- 25 to + 45

A TRIV wagon is permitted to operate in:

- permanent use on Ts lines.
- permanent use on Tn lines in the period of the year when temperature is expected to be above -25 °C.
- non-permanent use on Tn lines in the period of the year when temperature is expected to be below -25 °C.

Remark: It will be the choice of the applicant

| contracting entity

to decide the additional temperature range of the wagon according to its intended use (Tn, Ts, Tn + Ts, or nothing more than TRIV).

4.2.6.1.2.3 Humidity

The following external humidity levels shall be considered:

Yearly average: ≤ 75 % relative humidity.

On 30 days in the year continuously: between 75 % and 95 % relative humidity.

On the other days occasionally: between 95 % and 100 % relative humidity

Maximum absolute humidity: 30 g/m³ occurring in tunnels.

An operationally caused infrequent and slight moisture condensation shall not lead to any malfunction or failure.

The psychrometric charts of Annex G fig. G1 and G2 give the range of variation of the relative humidity for the different temperature classes that it is considered will not be exceeded for more than 30 days per year.

At cooled surfaces, 100 % relative humidity may occur, causing condensation on parts of equipment; this shall not lead to any malfunction or failure.

Sudden changes of the air temperature local to the vehicle may cause condensation of water on parts of equipment with rate of 3 K/s and maximum variation of 40 K.

These conditions occurring particularly when entering or leaving a tunnel shall not lead to any malfunction or failure of the equipment.

4.2.6.1.2.4 Air movement

For wind speeds to be considered for the design of freight wagons refer to section 4.2.6.2 Aerodynamic effects.

4.2.6.1.2.5 Rain

A rain rate of 6 mm/min shall be taken into account. The effect of rain shall be considered depending on the equipment installation together with wind and vehicle movement.

 OTIF	ROLLING STOCK FREIGHT WAGONS		UTP WAG Page 49 of 94	
	Status: ADOPTED	Version: 01	Ref.: A 94-02/3.2011	Original: EN

OTIF UTP

| Corresponding text in EU regulations

EU ref.

4.2.6.1.2.6 Snow, ice and hail

Consideration shall be given to the effect of all kinds of snow, ice and/or hail. The maximum diameter of hailstones shall be taken as 15 mm, larger diameters may occur exceptionally.

4.2.6.1.2.7 Solar radiation

Equipment design shall allow for direct exposure to solar radiation at the rate of 1120 W/m² for a maximum duration of 8 hours.

4.2.6.1.2.8 Resistance to pollution

The effects of pollution shall be considered in the design of equipment and components. The severity of pollution will depend upon the location of the equipment. Means may be provided to reduce pollution by the effective use of protection. The effects of the following kinds of pollution shall be considered:

Chemically active substances	Class 5C2 of EN 60721-3 to -5:1997
Contaminating fluids	Class 5F2 (electrical engine) of EN 60721-3 to 5:1997 Class 5F3 (thermal engine) of EN 60721-3 to 5:1997.
Biologically active substances	Class 5B2 of EN 60721-3 to 5:1997.
Dust	Defined by class 5S2 of EN 60721-3 to 5:1997.
Stones and other objects	Ballast and other of maximum 15 mm diameter.
Grasses and leaves, pollen, flying insects, fibres etc.	For the design of ventilation ducts
Sand	According to EN 60721-3 to 5:1997.
Sea spray	According to EN 60721-3 to 5:1997, Class 5C2.

4.2.6.2 Aerodynamic effects

Open point to be specified at the next revision of this UTP. This open point shall be considered as NOT relating to compatibility with infrastructure, see Annex JJ.

| TSI.

2009/
107/EC
Annex
JJ.1

4.2.6.3 Cross winds

For wagons subject to section 7.6.4, no mandatory provisions concerning cross winds apply to the design of wagons. Some operational measures could apply.

For other wagons this is an open point relating to compatibility with infrastructure, see Annex JJ.

See
15
2009/
107/EC
1.2

4.2.7 SYSTEM PROTECTION

4.2.7.1 Emergency Measures

There is no requirement for emergency exits or signposting relating to emergency exits on freight wagons. However, in the event of an accident, there is a requirement for a rescue plan and related information notices.

4.2.7.2 Fire Safety

4.2.7.2.1 General

- Design shall limit fire ignition and propagation.
- Toxic fume requirements are not described by this UTP

| TSI

¹⁵ The EU Commission Decision 2009/107/EC, Annex I, JJ.2

 OTIF	ROLLING STOCK FREIGHT WAGONS		UTP WAG Page 50 of 94	
	Status: ADOPTED	Version: 01	Ref.: A 94-02/3.2011	Original: EN

OTIF UTP

| Corresponding text in EU regulations

EU ref.

- The goods carried on freight wagons shall not be taken into account – neither as a primary ignition source nor as a mean of feeding fire propagation. In the case of dangerous goods carried on freight wagons, RID requirements shall be applied in all aspects of fire safety.
- The goods of freight wagons shall be protected against foreseeable sources of ignition on the vehicle.
- The material used on freight wagons shall limit the generation, propagation of fire, and production of smoke in the event of fire on primary ignition source of 7 kW during 3 min
- The design rules shall be applied for any fixed equipment of the vehicle, if it is a potential source of fire ignition, e.g. cooling devices containing fuel.
- A Contracting State | Member State shall not require smoke detectors to be installed on freight wagons.
- Flexible covers shall not be required to meet any fire criteria
- Floors material shall not be required to meet any fire criteria if they are protected according the first sentence of section 4.2.7.2.2.3.

4.2.7.2.2 Functional and technical specification

4.2.7.2.2.1 Definitions

Fire integrity:

The ability of a separating construction element, when exposed to fire on one side, to prevent the passage through it of flames, hot gases and other fire effluents or the occurrence of flames on the unexposed side.

Thermal insulation:

The ability of a separating construction element to prevent excessive transmission of heat.

4.2.7.2.2.2 Normative references

1	EN 1363-1 October 1999	Fire resistance tests Part 1: General requirements
2	EN ISO 4589-2 October 1998	Determination of burning behaviour by oxygen index – Part 2: Ambient temperature test
3	ISO 5658-2 1996-08-01	Reaction to fire tests – Spread of flame Part 2 Lateral spread on building products in vertical configuration
4	EN ISO 5659-2 October 1998	Plastic – Smoke generation Part 2: Determination of optical density by a single chamber test
5	EN 50355 November 2002	Railway applications – Railway rolling stock cables having special fire performance – Thin wall and standard wall – Guide to use

4.2.7.2.2.3 Design rules

Spark protection of the load shall be provided separately where the floor does not provide that protection.

The underside of the vehicle floor, in those locations where it is exposed to potential sources of fire and when spark protection is not provided, shall be provided with thermal insulation and fire integrity according the heat curve of EN 1363-1 [1] with a duration of 15 minutes.

4.2.7.2.2.4 Material requirements

In the following table the parameters used to define requirements and their characteristics, are listed. Also stated is whether the numerical value in the tables of requirements represents a maximum or minimum for compliance.

 OTIF	ROLLING STOCK FREIGHT WAGONS		UTP WAG Page 51 of 94
	Status: ADOPTED	Version: 01	Ref.: A 94-02/3.2011

OTIF UTP

Corresponding text in EU regulations

EU ref.

A reported result equal to the requirement is compliant.

Test method	Parameter	Units	Requirements definition
EN ISO 4589-2 [2]	LOI	% Oxygen	minimum
ISO 5658-2 [3]	CFE	KWm ⁻²	minimum
EN ISO 5659-2 [4]	D _{s max}	dimensionless	maximum

A short explanation of the test methods is given below:

- EN ISO 4589-2 [2] Determination of burning behaviour by oxygen index**
 This test specifies methods for determining the minimum concentration of oxygen, in ad-mixture with nitrogen, which will support combustion of small vertical test specimens under specified test conditions. The test results are defined as oxygen index values by volume percentages.
- ISO 5658-2 [3] Reaction to fire tests – Spread of flame – part 2: Lateral spread on products in vertical position**
 This test specifies a method of test for measuring the lateral spread of flame along the surface of a specimen of product orientated in vertical position. It provides data suitable for comparing the performance of essentially flat materials, composites or assemblies, which are used primarily as the exposed surfaces of walls.
- EN-ISO 5659-2 [4] Smoke generation part 2: Determination of optical density by a single-chamber test.**
 The specimen of the product is mounted horizontally within a chamber and exposed to thermal radiation on their upper surfaces at selected levels of constant irradiance of 50 kW/m² in the absence of a pilot flame.

Minimum Requirements

Parts or materials having a surface area less than the surface classification below, shall be tested with minimum requirements

Test method	Parameter	Units	Requirements
EN ISO 4589-2 [2]	LOI	% Oxygen	≥ 26

Requirements for material used as surface

Method : Conditions Parameter	Parameter	Units	Requirements definition
ISO 5658-2 [3] CFE	CFE	KWm ⁻²	≥ 18
EN ISO 5659-2 [4] 50kWm ⁻²	D _{s max}	dimensionless	≤ 600

Surface classification

All materials used shall meet the minimum requirements where the surface area of the material/item is less than 0.25 m² and

on a ceiling:

- the maximum dimension in any direction on the surface is less than 1 m and
- the separation from another surface is greater than the maximum extent of the surface (measured horizontally in any direction on the surface).

on a wall:

- the maximum dimension in a vertical direction is less than 1 m and
- the separation from another surface is greater than the maximum extent of the surface (measured vertically)

 OTIF	ROLLING STOCK FREIGHT WAGONS		UTP WAG Page 52 of 94	
	Status: ADOPTED	Version: 01	Ref.: A 94-02/3.2011	Original: EN

OTIF UTP

| Corresponding text in EU regulations

EU ref.

applies.

Cable used for electrical installation on freight wagons shall be in accordance with EN 50355 [5]. For fire safety requirements the hazard level 3 shall be taken in account.

4.2.7.2.2.5 Maintenance of the fire protection measures

The condition of fire integrity and thermal insulation measures (e.g. floor protection, wheel spark protection) shall be checked every overhaul period and at intermediate periods where it is appropriate to the design solution and field experience.

4.2.7.3 Electrical protection

4.2.7.3.1 General

All the metallic parts of a freight wagon that are at risk from excessive contact voltages or being at risk of causing accidents caused by electrical charges of any origin, shall be held at the same voltage as the rail.

4.2.7.3.2 Functional and technical specifications

4.2.7.3.2.1 Freight wagon bonding

The electrical resistance between the metallic parts and the rail shall not exceed 0.15 ohm.

These values shall be measured using 50 A direct current.

When materials that are poor conductors do not enable the above values to be reached, the vehicles themselves shall be fitted with the following protective bonding connections:

- The body shall be connected to the frame at least two different points;
- The frame shall be connected to each bogie at least once.

Each bogie shall be bonded reliably by means of at least one axle box.

If there are no bogies, no bonding connections are needed.

Each bonding connection shall be made of a flexible and non corrodible or corrosion protected material and have a minimum cross section according to the materials used (the reference is 35 mm² for copper).

Particularly restrictive conditions, from the point of view of eliminating risks, shall be taken in the case of special vehicles, for example roofless vehicles occupied by passengers in their own cars, vehicles used to transport dangerous good (listed in RID).

| the Directive 96/49/EC ¹⁶ and its valid Annex RID.)

4.2.7.3.2.2 Freight wagon electrical equipment bonding

Freight wagons fitted with electrical equipment shall have sufficient protection against electric shocks. Where there is an electrical installation on the freight wagon, any metallic parts of the electrical equipment liable to be touched by people shall be reliably bonded, if the standard voltage to which they may be subjected is higher than:

- 50 V dc
- 24 V ac
- 24 V between phases when the neutral point is not bonded
- 42 V between phases when the neutral point is bonded.

The cross-section of the bonding cable will depend on the current in the electrical

¹⁶ Directive 96/49/EC has been replaced by Directive 2008/68/EC on the inland transport of dangerous goods

 OTIF	ROLLING STOCK FREIGHT WAGONS		UTP WAG Page 53 of 94	
	Status: ADOPTED	Version: 01	Ref.: A 94-02/3.2011	Original: EN

OTIF UTP

| Corresponding text in EU regulations

EU ref.

installation, but shall be of a suitable size to ensure reliable operation of the circuit protect devices, in the event of a fault.

Any aerials fitted outside the freight wagons shall be completely protected from the voltage of the catenary or 3rd rail and the system shall form an electrical single unit bonded at one single point. An antenna fitted outside of the freight wagon that does not conform to the previous conditions, shall be isolated.

4.2.7.4 Fixing of tail lamps

4.2.7.4.1 General

All hauled vehicles shall have two tail lamp brackets at each end.

4.2.7.4.2 Functional and technical specifications

4.2.7.4.2.1 Characteristics

The tail lamp bracket shall have a fixing slot, as defined in Annex BB fig. BB1

4.2.7.4.2.2 Position

At the vehicle ends, the tail lamp brackets shall be arranged in such a way that:

- they are placed, wherever possible, between the buffers and the corners of the vehicles;
- they are spaced more than 1300 mm apart;
- the main centre line of the slot is perpendicular to the main centre line of the wagon;
- the upper side of the tail lamp bracket is less than 1600 mm above rail level. Where vehicles are fitted with fixed electric tail lamps, the centre line of the tail lamp shall be less than 1800 mm above rail level;
- the overall gauge of the tail lamp, as laid down in Annex BB fig. BB2, is complied with.

The tail lamp brackets shall be located in such a position that the lamp, when fitted, is not obscured and is easily accessible.

4.2.7.5 Provisions for the hydraulic/pneumatic equipment of freight wagons

4.2.7.5.1 General

Hydraulic and pneumatic equipment shall be so designed by structural strength and using suitable fittings so that bursting will not occur in normal operation.

Hydraulic systems installed on wagons shall be so designed to avoid any visible signs of leaking of hydraulic fluid.

4.2.7.5.2 Functional and technical specifications

Suitable protective measures shall ensure that hydraulic/pneumatic systems are not actuated inadvertently.

For hydraulically or pneumatically operated flaps/slide valves, an indicator shall show that they are properly locked.

4.2.8 MAINTENANCE: MAINTENANCE FILE

All maintenance activities undertaken on rolling stock must be performed in accordance with the provisions of this UTP.

| TSI.

All maintenance shall be undertaken in accordance with the Maintenance File applicable to the Rolling Stock.

The Maintenance File must be managed in accordance with the provisions specified in this

 OTIF	ROLLING STOCK FREIGHT WAGONS		UTP WAG Page 54 of 94	
	Status: ADOPTED	Version: 01	Ref.: A 94-02/3.2011	Original: EN

OTIF UTP

UTP.

After delivery of the rolling stock by the supplier, and acceptance thereof, a single entity called the Entity in Charge of Maintenance (ECM)¹⁷ shall assume responsibility for the maintenance of the rolling stock and management of the Maintenance File.

The National Vehicle Register (NVR) of the (first) admitting Contracting State shall indicate the ECM.

Corresponding text in EU regulations

TSI.

EU ref.

The Rolling Stock Register, kept by each Member State, shall state the entity responsible for the maintenance of the Rolling Stock and the management of the Maintenance File.

4.2.8.1 Definition, contents and criteria of the Maintenance File

4.2.8.1.1 Maintenance File

The maintenance file shall

be submitted to the approving authority as part of the Technical File annexed to the application for a technical admission (including admission of a Design Type).

be supplied with the vehicle, which is submitted to the verification process as specified in section 6.2.2.3 of this TSI, before putting into service.

The present article gives the criteria to verify the maintenance file.

The maintenance file is composed of:

– The Maintenance Design Justification File.

The Maintenance Design Justification File describes the methods used to design the maintenance; describes the tests, investigations, calculations carried out; gives the relevant data used for this purpose and justifies their origin.

This file shall contain:

- Description of the organisation in charge of the design of the maintenance
- Precedents, principles and methods used to design the maintenance of the vehicle.
- Utilisation profile (limits of the normal utilisation of the vehicle (km/month, climatic limits, authorised types of loads...) taken into account for the design of the maintenance).
- Tests, investigations, calculations carried out.
- Relevant data used to design the maintenance and origin of these data (return of experience, tests...).
- Responsibility and traceability of the design process (name, skills and position of the author and approver of each document).

– The Maintenance Documentation.

The Maintenance Documentation consists of all the documents necessary to realise the management and execution of the maintenance of the vehicle.

The maintenance documentation is composed of the following:

- Organic/functional description (breakdown structure).

The breakdown structure sets up the borders of the freight wagon by listing all the items belonging to the structure of that freight wagon and using an appropriate number of discrete levels to distinguish the relationships existing between different areas of the rolling stock. The last item identified along a branch shall be a Replaceable Unit.

¹⁷ See ATMF Annex A "Certification and auditing of Entities in Charge of Maintenance (ECM)".

 OTIF	ROLLING STOCK FREIGHT WAGONS		UTP WAG Page 55 of 94	
	Status: ADOPTED	Version: 01	Ref.: A 94-02/3.2011	Original: EN

OTIF UTP

| Corresponding text in EU regulations

EU ref.

- **Parts List.**
Containing the technical descriptions of the spare parts (replaceable units) in order to allow identification and procurement of the correct spares.
- **Safety/interoperability-relevant limits.**
For the safety/interoperability relevant components or parts, this document shall give the measurable limits not to be exceeded in service (to include operation in degraded mode).
- **Legal obligations.**
Some components or systems are subject to legal obligations (for instance brakes reservoirs, dangerous goods tanks ...). These obligations shall be listed.
- **Maintenance plan**
 - List, schedule and criteria of planned preventative maintenance operations,
 - List and criteria of conditional preventative maintenance operations,
 - List of corrective maintenance operations,
 - Maintenance operations governed by specific conditions of use.
The level of the maintenance operations shall be described. Also maintenance tasks to be carried out by the Railway Undertaking (servicing, inspections, brake tests, etc...) shall be described.
Note: Some maintenance operations like overhauls (level 4) and refurbishment, transformation or very heavy repairs (level 5) may not be defined at the moment when the vehicle is put into service. In this case, the responsibility and the procedures to define such maintenance operations shall be described.
- **Maintenance manuals and leaflets.**
For each maintenance operation listed in the maintenance plan, the manual explains the list of the tasks to be carried out.
Some maintenance tasks may be common to different operations or common to different vehicles.
These tasks are explained in specific maintenance leaflets.
The manuals and leaflets shall contain the following information:
 - Specific tools and facilities
 - Standardised or statutory specific staff competencies required (welding, non destructive testing...)
 - General requirements relative to Mechanical, Electrical, Fabrication and other engineering competencies.
 - Occupational and Operational Health and Safety provisions (including, but not limited to applicable legislation appertaining to the controlled use of substances hazardous to health and safety).
 - Environmental provisions
 - Details of the task to be carried out as a minimum:
 - Disassembly/assembly instructions
 - Maintenance criteria
 - Checks and tests
 - Parts required to undertake the task

 OTIF	ROLLING STOCK FREIGHT WAGONS		UTP WAG Page 56 of 94	
	Status: ADOPTED	Version: 01	Ref.: A 94-02/3.2011	Original: EN

OTIF UTP

Corresponding text in EU regulations

EU ref.

- Consumables required to undertake the task
- Tests and procedures to be undertaken after each maintenance operation before putting into service.
- Traceability and Records.
- Troubleshooting (fault diagnosis) manual
Including functional and schematic diagrams of the systems.

4.2.8.1.2 Management of the Maintenance File.

The Entity in Charge of Maintenance (ECM) | In the case where Railway Undertakings carry out maintenance on the Rolling Stock they use, the Railway Undertaking shall ensure that processes are in place to manage the maintenance and operational integrity of the rolling stock, including:

- Information necessary in order that the information recorded in the National Vehicle Register (NVR) and, if relevant, the OTIF Register of admitted types of vehicles may be updated; | – Information in the Rolling Stock Register,
- Asset Management, including records of all maintenance undertaken and due on the rolling stock (which shall be subject to specified time periods for differing levels of archive storage);
- Software where relevant;
- Procedures for the receipt and processing of specific information related to the operational integrity of rolling stock, arising as a result from any circumstance including but not limited to operational or Maintenance incidents, that have a potential to affect the safety integrity of rolling stock;
- Maintenance incidents that have a potential to affect the safety integrity of rolling stock;
- Procedures for the identification, generation and dissemination of specific information related to the operational integrity of rolling stock, arising as a result from any circumstance including but not limited to operational or maintenance incidents, with a potential to affect the safety integrity of rolling stock, and which is identified during any maintenance activity;
- Operational duty profiles of rolling stock (including, but not limited to tonne kilometres and total kilometres);
- Processes for the protection and validation of such systems.

In accordance with the provisions of Article 15 in Appendix G (ATMF) to the Directive 2004/49 Annex III, the Safety Management System of the Railway Undertaking of the ECM for freight wagons | Undertaking must demonstrate that suitable maintenance arrangements are in place, thereby ensuring on-going compliance with the essential requirements and the requirements of this

UTP | TSI including the requirements of the Maintenance File.

| In the case of entities other than the Railway Undertaking using the Rolling Stock being responsible for the maintenance of the Rolling Stock used, the Railway Undertaking using the Rolling

 OTIF	ROLLING STOCK FREIGHT WAGONS		UTP WAG Page 57 of 94	
	Status: ADOPTED	Version: 01	Ref.: A 94-02/3.2011	Original: EN

OTIF UTP

Corresponding text in EU regulations

EU ref.

Stock must ascertain that all relevant maintenance processes are in place and are actually applied. This must also be suitably demonstrated within the Safety Management System of the Railway Undertaking.

The entity responsible for the maintenance of the wagon shall ensure that reliable information about maintenance processes and data specified to be made available in the TSIs are available for the operating RU, and demonstrate on request of the operating RU that these processes ensure the compliance of the wagon with the Essential Requirements of Directive 2001/16/EC as modified by Directive 2004/50/EC.

4.2.9 OTHER REQUIREMENTS

4.2.9.1 Special types of wagons

2009/
107/EC
JJ.2,
2.10

For each of the following types of wagon subject to section 7.6.4, the related additional specifications apply:

- For wagons fitted with internal combustion engine: UIC leaflet 538;
- For multiple and articulated wagons: UIC leaflet 572;
- For wagons for the carriage of containers, swap bodies and horizontally loaded movable units: UIC leaflet 571-4;
- For heat insulated and refrigerated wagons: UIC leaflet 554-2;
- For semi trailers on bogies: UIC leaflet 597.

For other wagons not subject to section 7.6.4, see the note at the beginning of chapter 6.

4.2.9.2 Wagons designed to travel in United Kingdom

2009/
107/EC
JJ.2,
2.11

Wagons subject to section 7.6.4 must also comply with the UIC leaflet 503 requirements related to the specific UK conditions.

 OTIF	ROLLING STOCK FREIGHT WAGONS		UTP WAG Page 58 of 94	
	Status: ADOPTED	Version: 01	Ref.: A 94-02/3.2011	Original: EN

OTIF UTP

| Corresponding text in EU regulations

EU ref.

4.3 FUNCTIONAL AND TECHNICAL SPECIFICATIONS OF THE INTER-FACES

4.3.1 GENERAL

In the light of the essential requirements in section 3, the functional and technical specifications of the interfaces are arranged by subsystem in the following order:

- Control and command and signalling subsystem
- Traffic operation and management subsystem
- Telematics applications for freight services subsystem
- Infrastructure subsystem
- Energy subsystem

An additional interface has been identified with

- RID
- UTP Noise.

| the following Council Directive:

- The Council Directive 96/49/EC¹⁸ and its Annex (RID)

| An interface also exists with the Conventional Rail Noise TSI.

For each of these interfaces, the specifications are arranged in the same order as in section 4.2, as follows:

- Structures and mechanical parts
- Vehicle track interaction and gauging
- Braking
- Communication
- Environmental conditions
- System protection
- Maintenance

The following list is endorsed to indicate which subsystems are identified as having an interface basic parameters of this

UTP:

| TSI:

Structures and mechanical parts (section 4.2.2):

- Interface (e. g. Coupling) between vehicles, between set of Vehicles and between trains (section 4.2.2.1): *Traffic operation and management subsystem and Infrastructure subsystem*
- Safe access and egress for rolling stock (section 4.2.2.2): *Traffic operation and management subsystem*
- Strength of Main Vehicle Structure (section 4.2.2.3.1): *Infrastructure subsystem*
- Service (fatigue) Loads (section 4.2.2.3.3): *No interfaces identified*
- Stiffness of the main vehicle structure (section 4.2.2.3.4): *No interfaces identified*
- Securing of Freight (section 4.2.2.3.5): *Traffic operation and management subsystem*
- Doors closing and locking (section 4.2.2.4): *No interfaces identified*
- Marking of freight wagons (section 4.2.2.5): *Traffic operation and management*

¹⁸ Directive 96/49/EC has been replaced by Directive 2008/68/EC on the inland transport of dangerous goods

 OTIF	ROLLING STOCK FREIGHT WAGONS		UTP WAG Page 59 of 94	
	Status: ADOPTED	Version: 01	Ref.: A 94-02/3.2011	Original: EN

OTIF UTP

| Corresponding text in EU regulations

EU ref.

subsystem

- Dangerous goods (section 4.2.2.6): *Traffic operation and management subsystem and RID.*

| The Council Directive 96/49/EC¹⁸
and its Annex RID

Vehicle track interaction and gauging (section 4.2.3):

- Kinematic gauge (section 4.2.3.1): *Infrastructure subsystem*
- Static axle load, dynamic wheel load and linear load (section 4.2.3.2) (*Control command and signalling subsystem and Infrastructure subsystem*)
- Rolling stock parameters, which influence ground based train monitoring systems (section 4.2.3.3): *Control command and signalling subsystem*
- Vehicle dynamic behaviour (section 4.2.3.4) *Infrastructure subsystem*
- Longitudinal compressive forces (section 4.2.3.5): *Traffic operation and management subsystem and Infrastructure subsystem*

Braking (section 4.2.4):

- Braking performance section 4.2.4.1: *Control command and signalling subsystem and Traffic operation and management subsystem*

Communication (section 4.2.5):

- Vehicle capability to transmit information from vehicle to vehicle (section 4.2.5.1): *Not yet applicable to freight wagons*
- Vehicle capability to transmit information between ground and vehicle (section 4.2.5.2): *No interfaces identified*

Environmental conditions (section 4.2.6)

- Environmental conditions (section 4.2.6.1): *Traffic operation and management subsystem and Infrastructure subsystem*
- Aerodynamic effects (section 4.2.6.2): *Traffic operation and management subsystem*
- Cross winds (section 4.2.6.2): *Traffic operation and management subsystem*

System protection (section 4.2.7):

- Emergency Measures (section 4.2.7.1): *Traffic operation and management subsystem*
- Fire safety (section 4.2.7.2): *Infrastructure subsystem*
- Electrical protection (section 4.2.7.3): *No interfaces identified*

Maintenance (section 4.2.8):

- Maintenance file (section 4.2.8): *Traffic operation and management subsystem and Noise UTP.*

| TSI.

4.3.2 CONTROL AND COMMAND AND SIGNALLING SUBSYSTEM –

4.3.2.1 Static axle load, dynamic wheel load and linear load (section 4.2.3.2)

Section 4.2.3.2 of this

UTP

| TSI

specifies the **minimum** axle loads. The corresponding specifications will be included in the Control Command and Signalling UTP. Until that UTP has entered into force, the specifications in 4.3.2.1.1 shall apply.

| are laid down in the Control and Command and Signalling TSI Annex A Appendix 1 section 3.1.

 OTIF	ROLLING STOCK FREIGHT WAGONS		UTP WAG Page 60 of 94	
	Status: ADOPTED	Version: 01	Ref.: A 94-02/3.2011	Original: EN

OTIF UTP

Corresponding text in EU regulations

EU ref.

4.3.2.1.1 Vehicle Mass

The axle load shall be at least 5 t unless the braking force of the vehicle is provided by brake blocks, in which case the axle load shall be at least 3.5 t for use on existing lines.

CCS
2006/679/
EC Annex
A, Appen-
dix 1
3.1.1

The axle load shall be at least 3.5 t for use on new or upgraded lines.

3.1.2

4.3.2.1.2 Axle distances

WAG

The Control and Command and Signalling UTP will specify

TSI specifies

the maximum axle distance in order to satisfy the requirement for track circuits.

Until that UTP has entered into force, the following specifications shall apply:

The corresponding specifications are laid down in the Control and Command and Signalling TSI Annex A Appendix 1 section 2.1.

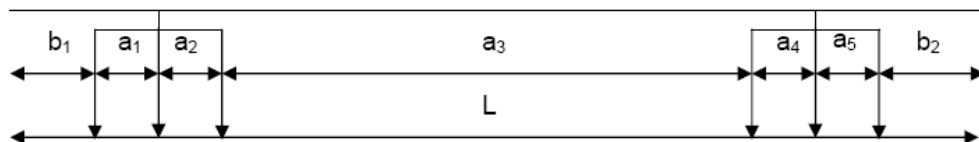

CCS
Annex A,
Appen-
dix 1
1.2

[Fig. 6]

a_i = distance between following axles, where $i = 1, 2, 3, \dots, n-1$, where n is total number of axles of the vehicle

b_x = longitudinal distance from first axle (b_1) or last axle (b_2) to the nearest end of the vehicle, i.e. nearest buffer/nose

L = total length of the vehicle

The distance a_i [Fig. 6] shall not exceed 17500 mm for existing lines, 20000 mm for use on new lines. 2.1.1

The distance b_x [Fig. 6] shall not exceed 4200 mm. 2.1.2

The distance a_i [Fig. 6] shall not be less than: 2.1.3

$$a_i = v \times 7.2$$

where v is vehicle maximum speed in km/h and distance a_i is in mm if the vehicle maximum speed does not exceed 350 km/h; for higher speeds the limits will have to be defined when necessary.

The distance $L - (b_1 + b_2)$ (Fig. 6.) shall not be less than 3000 mm. 2.1.4

4.3.2.2 Wheels

WAG

Wheels are specified in section 5.4.2.3. The corresponding specifications will be included in the Control Command and Signalling UTP. are laid down in the Control and Command and Signalling TSI section 4.2.11.

4.3.2.2.1 Compatibility with Track-side Train Systems

CCS
2006/679/
EC
4.2.11

This Basic Parameter describes the characteristics of Track-side train detection systems that are necessary to be activated by Rolling Stock which conforms to this UTP freight wagons. the Rolling Stock TSI.

Rolling stock shall have the characteristics necessary for the operation of track-side train detection systems.

These characteristics are defined in the following sections of this UTP:

Axle distances: 4.2.3.2

Wheel geometry: 5.4.2.3

Vehicle mass (minimum axle load): 4.2.3.2

Metal free space around wheel: chapter 6

In (TSI CCS) Annex A, Appendix 1 the requirements related to the characteristics of a vehicle are specified. These characteristics are defined in TSI Rolling Stock HS and TSI Rolling Stock Freight wagons in the sections given in the table,

 OTIF	ROLLING STOCK FREIGHT WAGONS		UTP WAG Page 61 of 94	
	Status: ADOPTED	Version: 01	Ref.: A 94-02/3.2011	Original: EN

<i>OTIF UTP</i>	<i>Corresponding text in EU regulations</i>	<i>EU ref.</i>
<p>Metal-mass of vehicle: <u>Open point</u> Wheel material: 5.4.2.3 Impedance between wheels: 4.2.3.3.1 Use of composite brake blocks: <u>Open point</u></p>	and will be included in future Rolling Stock TSI's. (Table not shown)	
<p>4.3.2.3 Rolling stock parameters which influence ground based train monitoring systems</p> <p>Hot axle box detectors, see section 4.2.3.3.2.</p> <p>The corresponding specification will be included in the Control Command and Signalling UTP.</p>	<p>(To be specified at the next revision of this TSI).</p> <p>is laid down in the Control and Command and Signalling TSI section 4.2.10.</p>	WAG
<p>4.3.2.3.1 HABD (Hot axle box detector)</p> <p>This Basic Parameter specifies the requirements for the track-side equipment, used to check if the temperature of passing rolling stock axle bearings has exceeded a certain value and to transmit this information to a control centre.</p> <p>The requirements will be included in the Control Command and Signalling UTP. Until that UTP has entered into force, the following specifications shall apply:</p> <p>For wagons subject to section 7.6.4 Annex LL shall apply. For other wagons <u>not</u> subject to section 7.6.4 is this an open point, see Annex JJ.</p> <p>Electrical detection of the wheelset (section 4.2.3.3.1).</p> <p>Requirements for electrical detection of the wheelset will be included in the Control Command and Signalling UTP. Until that UTP has entered into force, the following specifications shall apply:</p>	<p>are defined in Annex A (of TSI CCS), Appendix 2. (Open point)</p> <p>The open point identified in section 4.2.3.3.2 of this TSI is closed if the wagon complies with the specifications of the related ERA Technical Document.</p> <p>are described in the Control and Command and Signalling TSI Annex A Appendix 1 section 3.5.</p>	CCS 2006/679/ EC 4.2.10
<p>4.3.2.3.2 Impedance between wheels</p> <p>Electrical resistance between the running surfaces of the opposite wheels of a wheelset shall not exceed:</p> <ul style="list-style-type: none"> • 0.01 Ohm for new or reassembled wheelsets • 0.05 Ohm after overhaul of wheel sets <p>The resistance is measured by a measuring voltage that is between 1.8 V_{DC} and 2.0 V_{DC} (Open voltage)</p>		CCS 2006/679/ EC, Annex A, Appen- dix 1 3.5.1
<p>4.3.2.3.3 Rolling Stock compatibility with Train Detection Systems</p> <p>The corresponding specifications will be included in the Control Command and Signalling UTP. Until that UTP has entered into force, the specifications in section 4.2.2.2.1 above shall apply.</p>	are laid down in the Control and Command and Signalling TSI section 4.2.11.	3.5.2
<p>4.3.2.4 Braking</p> <p>4.3.2.4.1 Braking performance</p> <p>The Control Command and Signalling UTP (CCS)</p>	TSI Annex A index 4	
might specify the maximum number of steps of the deceleration curve (see		

 OTIF	ROLLING STOCK FREIGHT WAGONS		UTP WAG Page 62 of 94	
	Status: ADOPTED	Version: 01	Ref.: A 94-02/3.2011	Original: EN

OTIF UTP | Corresponding text in EU regulations | EU ref.

4.2.4.1.2.2 b)).

Until UTP CCS has entered into force, the specifications in UNISIG SUBSET-026 - System Requirement Specification, version 2.3.0 shall apply.

CCS
2008/386/
EC

4.3.3 TRAFFIC OPERATION AND MANAGEMENT SUBSYSTEM

Interfaces to the traffic and operation management subsystem are in consideration (references to this TSI are open points).

4.3.3.1 Interface between vehicles, between sets of vehicles and between trains

The Traffic Operation and Management UTP (OPE) may include regulations or national operating rules for shunting, specify shunting speeds in accordance with the energy absorption capability of the buffers specified in section 4.2.

| TSI

When it has entered into force, the Traffic Operation and Management UTP OPE may specify

| TSI specifies

the maximum train mass considering the geographical conditions in accordance with the strength of the coupler specified in section 4.2.

Until UTP OPE has entered into force the operating Railway Undertaking shall, in the composition of a train, ascertain that the strength of the coupler(s) will not be exceeded.

4.3.3.2 Doors closing and locking

No interface.

4.3.3.3 Securing of freight

Loading rules are required to specify how freight wagons are to be loaded, taking account of the way the freight wagon has been designed to carry particular goods.

4.3.3.4 Marking of freight wagons

The Traffic Operation and Management UTP, once in force, will determine the specifications related to vehicle numbering.

| TSI determines

Until then the specifications in section 4.2.2.5.1 (Annex PP) of this UTP shall apply.

| [Annex P to TSI OPE]

4.3.3.5 Dangerous goods

The traffic operation and management subsystem UTP shall specify that when freight wagons carrying dangerous goods are included in a train consist, the train configuration shall comply with the requirements of RID.

| TSI

| the Council Directive 96/49/EC¹⁹ and its Annex in their valid version.

4.3.3.6 Longitudinal compressive forces

¹⁹ Directive 96/49/EC has been replaced by Directive 2008/68/EC on the inland transport of dangerous goods

 OTIF	ROLLING STOCK FREIGHT WAGONS		UTP WAG Page 63 of 94	
	Status: ADOPTED	Version: 01	Ref.: A 94-02/3.2011	Original: EN

OTIF UTP

| Corresponding text in EU regulations

EU ref.

With respect to longitudinal compressive forces, the Traffic and Operation Management Subsystem

UTP may determine

| TSI determines

operational requirements for:

- driving trains
- drivers handling of trains including braking in various line conditions
- banking and shunting of trains due to lines and network
- coupling and handling special types of vehicles (Road-Railer™, Kombirail) in trains
- locomotives location in the train

No requirements are included in this UTP WAG

4.3.3.7 Braking performance

The method of calculating the deceleration profile for a new wagon is described in this

UTP

| TSI

by using its technical vehicle parameters.

The method of calculating braking power of a train under service conditions will be described in the Traffic Operation and Management

UTP.

| TSI.

The traffic operation and management

UTP may

| TSI will

define rules for dealing with the following subjects:

- Marshalling of trains
- Deactivating the brake, releasing the brake and selecting the brake-mode
- Communicating to the train crew and ground staff the means and conditions for parking of wagons
- Reducing speed according to actual adhesion conditions on a line
- Making available scotches beside the tracks where it is necessary. The freight wagons shall not be required to carry scotches
- Dealing with degraded mode, especially for short trains
- Testing the brake (operational inspection)
- Isolating the brake of a wagon with excessive deceleration rate compared to the remainder of the train.

No requirements for these subjects are included in this UTP WAG.

4.3.3.8 Communications

No Interface.

4.3.3.8.1 Vehicle Capability to transmit information between ground and vehicle

No interface.

4.3.3.9 Environmental conditions

When a limit of the climactic conditions defined in section 4.2.6.1.2 of this

UTP

| TSI

is exceeded, the system is in a degraded mode. In this case operational restrictions shall be considered and information given to the Railway Undertaking or train driver.

 OTIF	ROLLING STOCK FREIGHT WAGONS			UTP WAG Page 64 of 94
	Status: ADOPTED	Version: 01	Ref.: A 94-02/3.2011	Original: EN

OTIF UTP

Corresponding text in EU regulations

EU ref.

Regarding temperature the OTIF Register of admitted types of vehicles and the infrastructure register give the values for normal operation.

4.3.3.10 Aerodynamic effects

To be specified at the next revision of this UTP WAG. | TSI.

2009/
107/EC
Annex
JJ.1

4.3.3.11 Cross winds

No requirements in this UTP WAG. | Operational measures should be taken if dangerous cross winds occur.

4.3.3.12 Emergency Measures

The Traffic Operation and Management UTP may, when it has entered into force, specify that emergency arrangements and rescue plans shall be set up. | TSI will

Until then, the Technical File shall have an annex containing adequate information based on which the Railway Undertakings and civil emergency authorities can develop instructions and train their staff to handle emergency and degraded situations; the information shall include details of how to re-rail vehicles, and procedures to make damaged vehicles safe for movement. | Railway undertakings shall also consider how their own staff and the staff of the civil emergency authorities are to be trained, including practical simulation exercises. The associated instructions shall include

The Instructions for dealing with emergency situations shall take account of the risks to which the emergency response staff may be exposed, and give details of how those risks are to be managed. Details of risks arising from the design of the freight wagon and advice on how to mitigate such risks shall be included in the instructions annexed to the Technical File. | given to the Railway Undertaking to enable comprehensive instructions to be written, by or on behalf of the freight wagon designer or builder.

These instructions shall also include a list of parameters that need to be checked on damaged or derailed freight wagons in a degraded situation.

4.3.3.13 Fire Safety

See footnote ²⁰

Information to the drivers from the Infrastructure manager	Provide rules and rescue plan for operation in case of fire.
---	--

4.3.4 TELEMATICS APPLICATIONS FOR FREIGHT SERVICES SUBSYSTEM

There are no interfaces between the two subsystems

4.3.5 INFRASTRUCTURE SUBSYSTEM

To be specified at a later stage, once the infrastructure subsystem UTP INF is available. | TSI

4.3.5.1 Interface between vehicles, between sets of vehicles and between trains

²⁰ This provision does not seem to be relevant for the construction of the wagon

 OTIF	ROLLING STOCK FREIGHT WAGONS		UTP WAG Page 65 of 94	
	Status: ADOPTED	Version: 01	Ref.: A 94-02/3.2011	Original: EN

OTIF UTP

Corresponding text in EU regulations

EU ref.

4.3.5.2 Strength of Main Vehicle Structure and Securing of Freight

4.3.5.3 Kinematic gauge

4.3.5.4 Static axle load, dynamic wheel load and linear load

4.3.5.5 Vehicle dynamic behaviour

4.3.5.6 Longitudinal compressive forces

4.3.5.7 Environmental conditions

4.3.5.8 Fire protection

4.3.6 ENERGY SUBSYSTEM

There are no interfaces between the two subsystems.

4.3.7 RID (APPENDIX C TO THE CONVENTION) | THE COUNCIL DIRECTIVE 96/49/EC ²¹ AND ITS ANNEX (RID).

4.3.7.1 Dangerous goods

All special regulations concerning the transport of dangerous goods are fixed in RID.

the Council Directive 96/49/EC and its Annex (RID) in their valid version.

All derogations, restrictions and exemptions are also listed in section II of the Council Directive 96/49/EC in its valid version.

All derogations, restrictions and exemptions are also listed in RID.

section II of the Council Directive 96/49/EC in its valid version.

4.3.8 CONVENTIONAL RAIL NOISE UTP

| TSI

To ensure ongoing adherence to the levels set in the Conventional Rail Noise UTP (UTP NOI) wagons shall be appropriately maintained.

| TSI (see its section 4.5),

The Maintenance File defined in section 4.2.8 shall include the relevant measures to deal with wheel tread defects.

4.4 OPERATING RULES

For T_{RIV} wagon the environmental conditions

(see section 4.2.6.1 of this UTP) | (see § 4.2.6.1 of the TSI)

low temperatures (-25 °C to -40 °C) and/or conditions of snow/ice shall be taken carefully into account in the design phase of rolling stock. Even if this is done, a lower level of functionality sometimes has to be accepted and managed during operation. This shall be compensated for by the use of operational procedures to ensure the same overall safety level. It is also important that operators have the necessary qualifications or skills for operating under those conditions.

²¹ Directive 96/49/EC has been replaced by Directive 2008/68/EC on the inland transport of dangerous goods

 OTIF	ROLLING STOCK FREIGHT WAGONS		UTP WAG Page 66 of 94	
	Status: ADOPTED	Version: 01	Ref.: A 94-02/3.2011	Original: EN

OTIF UTP

| Corresponding text in EU regulations

EU ref.

4.5 MAINTENANCE RULES

In light of the essential requirements in section 3, the maintenance rules specific to the rolling stock freight wagon subsystem concerned by this

UTP | TSI

are described in subsections:

- 4.2.2.2 Safe access and egress for rolling stock
- 4.2.2.3 Strength of main vehicle structure and securing of freight
- 4.2.2.4 Doors closing and locking
- 4.2.2.6 Dangerous goods
- 4.2.3.1 Kinematic gauge
- 4.2.3.4 Vehicle dynamic behaviour
- 4.2.3.4.2.3 Maintenance rules
- 4.2.3.5 Longitudinal compressive forces
- 4.2.5.2 Vehicle capability to transmit information between ground and vehicle
- 4.2.7.2 Fire safety

and in particular in subsection

- 4.2.8 Maintenance.

The maintenance rules shall be such as to enable the wagon to pass the assessment criteria specified in section 6 throughout its lifetime.

The party responsible for the management of the maintenance file as defined in section 4.2.8 shall define the tolerances and intervals appropriately to ensure ongoing compliance. It is also responsible for deciding the inservice values when not specified in this

UTP. | TSI.

This means the assessment procedures described in chapter 6 of this

UTP | TSI

shall be fulfilled for type approval, and are not necessarily appropriate for maintenance. Not all tests may be made at every maintenance event and those that are may be subject to wider tolerances.

The combination of the above assures continuous compliance with the essential requirements through the life of the vehicle.

4.6 PROFESSIONAL QUALIFICATIONS

The professional qualifications required for the **operation** of the Conventional Rail Rolling Stock subsystem will be covered by the

UTP OPE | TSI

Traffic Management and Operation

The competence requirements for the **maintenance** of the Conventional Rail Rolling Stock subsystem shall be detailed in the maintenance plan (see section 4.2.8). As activities related to maintenance level 1²² are not in the scope of this

UTP, | TSI,

but in the one of the

UTP OPE | TSI

²² Maintenance level 1 refers to the actions of technical checking (called “technical transfer inspection”), monitoring and necessary repair undertaken by a railway undertaking before it includes a wagon in one of its departing trains. See UIC leaflet 471-2 and GCU (General Contract of Use), in particular Appendix 9.

 OTIF	ROLLING STOCK FREIGHT WAGONS		UTP WAG Page 67 of 94	
	Status: ADOPTED	Version: 01	Ref.: A 94-02/3.2011	Original: EN

OTIF UTP

| Corresponding text in EU regulations

EU ref.

Traffic Operation and Management; professional qualifications associated with these activities are not specified in this UTP freight wagons.

| TSI Rolling Stock.

4.7 HEALTH AND SAFETY CONDITIONS

Apart from requirements specified in the maintenance plan (see section 4.2.8) in this UTP, there are no additional requirements to applicable

| TSI,

| European regulations and

national regulations

| compatible with European ones

on health and safety for maintenance or operations staff.

Activities related to maintenance level 1 are not in the scope of this UTP,

| TSI,

but in the one of the

UTP OPE

| TSI

Traffic Operation and Management; health and work associated with these activities are not specified in this UTP.

| TSI Rolling Stock.

4.8 INFRASTRUCTURE AND ROLLING STOCK REGISTERS ²³

4.8.1 INFRASTRUCTURE REGISTER

This UTP contains no detailed specifications on this subject. Annex KK is therefore empty.

| The Infrastructure Register shall contain the following mandatory data as listed in Annex KK.

The requirements for the conventional rail infrastructure register content with regard to the subsystem Rolling Stock are specified in subsection 4.2.6.1 (environmental conditions). The infrastructure manager is responsible for the correctness of the data provided for inclusion in the infrastructure register.

4.8.2 ROLLING STOCK REGISTER

The data related to admission are registered in the National Vehicle Register according to the OTIF NVR regulation in force. The technical data shall be registered in the OTIF Register of admitted types of vehicles according to regulations adopted by the Committee of Technical Experts.

| The Rolling Stock Register shall contain the following mandatory data for all freight wagons, which are in accordance with this TSI as listed in Annex H.

If the Member State of registration changes, the contents of the Rolling Stock Register for that wagon shall be passed from the original State of registration to the new State of registration.

The data contained in the Rolling Stock Register is required by:

- The Member State to confirm that the freight wagon meets the requirements in accordance with this TSI

²³ The whole section 4.8 in the TSI WAG will need to be updated in order to take account of Articles 34 and 35 of Directive 2008/57/EC.

 OTIF	ROLLING STOCK FREIGHT WAGONS			UTP WAG Page 68 of 94
	Status: ADOPTED	Version: 01	Ref.: A 94-02/3.2011	Original: EN

OTIF UTP

Corresponding text in EU regulations

EU ref.

- The Infrastructure Manager to confirm that the freight wagon is compatible with the infrastructure over which it is intended to operate
- The Railway Undertaking to confirm that the freight wagon is suitable for its traffic requirements.

In the territory of all Member States, the requirements applicable in neighbouring third countries are applied to freight wagons arriving from or going to these third countries, subject to the additional requirements which define minimum criteria of the interfaces between the freight wagons and the infrastructure and the interfaces of these freight wagons to locomotives.

Where the data which is available concerning these freight wagons is less than required for the Rolling stock register, the Railway Undertaking shall put in place arrangements to ensure that the vehicles are safe to operate on the TSI-compliant

 OTIF	ROLLING STOCK FREIGHT WAGONS		UTP WAG Page 69 of 94	
	Status: ADOPTED	Version: 01	Ref.: A 94-02/3.2011	Original: EN

OTIF UTP

Corresponding text in EU regulations

EU ref.

5. INTEROPERABILITY CONSTITUENTS

5.1 DEFINITION

In this UTP, the term “interoperability constituent” is equivalent to an “element of construction” defined in Article 2 of Appendix G (ATMF) to the Convention. An “element of construction” or “constituent” means

any elementary component, group of components, complete or subassembly of equipment incorporated or intended to be incorporated into a subsystem upon which the interoperability of

the OTIF conventional rail system

According to Article 2(d) of Directive 2001/16/EC: Interoperability constituents are

the trans-European conventional rail system

depends directly or indirectly. The concept of an “element of construction” covers both tangible objects and intangible objects such as software.

Interoperability constituents described in section 5.3 are constituents, whose technology, design, material, manufacturing and assessment processes are defined and enable their specification and assessment.

An interoperability constituent (IC) shall comply with the technical specifications of this chapter whether it is admitted separately as an IC or as part of a subsystem.

Separate technical admission of elements of construction (interoperability constituents) is **not mandatory** in the COTIF regulations, but a Contracting State may decide to approve them according to this UTP on a voluntary basis, on condition that they fulfil the provisions in this and other relevant UTPs. The technical admission shall be evidenced by the competent authority or suitable body in the form of a declaration of conformity according to section 6.1.1 of this UTP and UTP GEN-D.

Regulations from a regional organisation may require mandatory admission of elements of construction (ICs).

5.2 INNOVATIVE SOLUTIONS

As announced in section 4.1 of this UTP

TSI

innovative solutions may require new specification and/or new assessment methods. These specifications and assessment methods shall be developed by the process described in sections 6.1.2.3 (and 6.2.2.2).

5.3 LIST OF CONSTITUENTS

The interoperability constituents are covered by the relevant provisions of Appendix F (APTU) and G (ATMF) to the Convention

Directive 2001/16/EC

 OTIF	ROLLING STOCK FREIGHT WAGONS		UTP WAG Page 70 of 94	
	Status: ADOPTED	Version: 01	Ref.: A 94-02/3.2011	Original: EN

OTIF UTP

| Corresponding text in EU regulations

EU ref.

and are listed below:

5.3.1 STRUCTURES AND MECHANICAL PARTS

5.3.1.1 *Buffers*

5.3.1.2 *Draw gear*

5.3.1.3 *Decals for Markings*

5.3.2 VEHICLE TRACK INTERACTION AND GAUGING

5.3.2.1 *Bogie and Running Gear*

5.3.2.2 *Wheelsets*

5.3.2.3 *Wheels*

5.3.2.4 *Axles*

5.3.3 BRAKING

5.3.3.1 *Distributor*

5.3.3.2 *Relay valve for variable load/Automatic empty-load change over brake*

5.3.3.3 *Wheel slide protection device*

5.3.3.4 *Slack adjuster*

5.3.3.5 *Brake cylinder/actuator*

5.3.3.6 *Pneumatic half coupling*

5.3.3.8 *End Cock*

5.3.3.8 *Isolating device for distributor*

5.3.3.9 *Brake pad*

5.3.3.10 *Brake blocks*

5.3.3.11 *Brake Pipe Emptying Accelerator valve*

5.3.3.12 *Automatic load sensing & empty/load changeover device*

5.3.4 COMMUNICATION

5.3.5 ENVIRONMENTAL CONDITIONS

5.3.6 SYSTEM PROTECTION

5.4 CONSTITUENTS PERFORMANCES AND SPECIFICATIONS

5.4.1 STRUCTURES AND MECHANICAL PARTS

5.4.1.1 Buffers

The specifications of the interoperability constituent buffers are described in section 4.2.2.1.2.1 buffers, paragraph "buffer characteristics".

The interfaces of the interoperability constituents "buffers" are described in 4.3.3.1 for traffic operation and management and in 4.3.5.1 for infrastructure.

5.4.1.2 Draw Gear

The specifications of the interoperability constituent draw gear are described in section 4.2.2.1.2.2 draw gear, paragraph "draw gear characteristics" and section 4.2.2.1.2.3 interaction of draw- and buffing-gear, paragraph "draw gear and buffing gear characteristics".

The interfaces of the interoperability constituents draw gear are described in 4.3.3.1 for traffic operation and management and in 4.3.5.1 for infrastructure.

 OTIF	ROLLING STOCK FREIGHT WAGONS		UTP WAG Page 71 of 94	
	Status: ADOPTED	Version: 01	Ref.: A 94-02/3.2011	Original: EN

OTIF UTP

| Corresponding text in EU regulations

EU ref.

5.4.1.3 Decals for Markings

Where markings are achieved by using decals, these are Interoperability Constituents. These markings are specified in Annex B

5.4.2 VEHICLE TRACK INTERACTION AND GAUGING

5.4.2.1 Bogie and Running Gear

The integrity of the structure of the bogie and running gear is important for the safe operation of the railway system.

The loading environment of the bogie and running gear is determined by

- the maximum speed
- static track features (alignment, track gauge, cant, rail inclination, track irregularities)
- dynamic track features (horizontal and vertical track stiffness and track damping)
- wheel/rail contact parameters (Wheel and rail profile, track gauge)
- wheel defects (e.g. wheel flats, out of roundness)
- mass, inertia and stiffness of car body, bogies and wheelsets
- suspension characteristic of the vehicles
- distribution of the payload
- braking performance.

The specifications of the interoperability constituents bogie and running gear are described in 4.2.3.4.1, 4.2.3.4.2.1 and 4.2.3.4.2.2 Vehicle Track Interaction and Gauging.

It is permissible for bogies to be used in other application without further validation (testing) provided the range of applicable parameters in the new application (including those of the vehicle body) remain within the range already proved.

In order to ensure safe operation of the bogies and running gear, they shall be designed to withstand the loading environment expected during their operation. In particular, the bogies and running gear shall be compliant with the test conditions detailed in section 6.

The list containing bogie designs that at the time of publication are already considered to meet the requirements of this TSI for some applications is attached in Annex Y.

The Interfaces of the interoperability constituent bogie and running gear with the subsystem Control and Command and Signalling relative to the spacing of the axles are described in 4.3.2.1 Static axle load, dynamic wheel load and linear load.

Freight wagons shall be designed such that operating through curves, on ramps and with access on ferry boats is possible without contact between bogies and car body. The side bearers of the bogie wagons shall have sufficient overlap in the smallest curve radius for which the wagon has been designed.

If the wagon is only capable of operating on a smaller ferry boat angle than 2.5 degrees, then the marking according to Annex B, table B.1 position number 19 | Fig. B 25, shall be applied.

If the wagon is only capable of operating on a bigger curve radius than 35 m, then the marking according to Annex B, table B.1 position number 18 | Fig. B 24 shall be applied.

 OTIF	ROLLING STOCK FREIGHT WAGONS		UTP WAG Page 72 of 94	
	Status: ADOPTED	Version: 01	Ref.: A 94-02/3.2011	Original: EN

OTIF UTP

| Corresponding text in EU regulations

EU ref.

5.4.2.2 Wheelsets

Track Interaction and Gauging 4.2.4.1.2.5 Braking and 4.2.7.3.2.1 System protection.

The detailed specification is described in section 4.2.3.3.1 Electrical resistance, in section 4.2.4.1.2.5 energy limits (in braking) in Annex K and in Annex E, which includes example solutions in some elements.

A complete functional specification of the IC wheelset is deferred until the next revision of this

UTP. | TSI.

The Interfaces of the interoperability constituent wheelset with the subsystem Control and Command and Signalling are described in 4.3.2.1 Static axle load, dynamic wheel load and linear load.

5.4.2.3 Wheels

The detailed specification is described in Annex L, which includes example solutions in some elements and Annex E.

A complete functional specification of the IC wheel is deferred until the next revision of this

UTP. | TSI.

5.4.2.4 Axles

The detailed specification is described in Annex M, which includes example solutions in some elements.

A complete functional specification of the IC axles is deferred until the next revision of this

UTP. | TSI.

The Interfaces of the interoperability constituent axle wheelset with the subsystem Control and Command and Signalling are described in 4.3.2.1 Static axle load, dynamic wheel load and linear load.

For wagons subject to section 7.6.4, in addition to the specifications of this section 5.4.2.4 and Annex M 1.4 of this

UTP, | TSI,

for maximum permissible stresses the following standards apply: EN 13103 section 7, EN 13260 section 3.2.2 and EN 13261 section 3.2.3.

For other wagons not subject to section 7.6.4, see the note at the beginning of chapter 6.

5.4.3 BRAKING

5.4.3.1 Constituents approved at the time of publication of this

UTP. | TSI.

The list containing brake system and brake constituent designs that at the time of publication are already considered to meet the requirements of this

UTP | TSI

for some applications is attached in Annex FF.

5.4.3.2 Distributor

The functional specification of the interoperability constituent distributor is described in 4.2.4.1.2.2 Braking Performance Elements and 4.2.4.1.2.7 Air Supply.

The interfaces of the interoperability constituent are described in Annex I section I.1.

 OTIF	ROLLING STOCK FREIGHT WAGONS		UTP WAG Page 73 of 94	
	Status: ADOPTED	Version: 01	Ref.: A 94-02/3.2011	Original: EN

OTIF UTP

| Corresponding text in EU regulations

EU ref.

5.4.3.3 Relay valve for variable load/Automatic empty-load change over brake

The functional specification of the interoperability constituent relay valve for variable load/Automatic empty/load changeover brake is described in 4.2.4.1.2.2 Braking Performance Elements and 4.2.4.1.2.7 Air Supply.

The interfaces of the interoperability constituent are described in Annex I section I.2.

5.4.3.4 Wheel slide protection device

The functional specification of the interoperability constituent wheel slide protection device is described in 4.2.4.1.2.6 wheel slide protection and 4.2.4.1.2.7 Air Supply.

The specification of the interoperability constituent is described in Annex I section I.3.

5.4.3.5 Slack adjuster

The functional specification of the interoperability constituent slack adjuster is described in 4.2.4.1.2.3 Mechanical Components.

The specification of the interoperability constituent is described in Annex I section I.4.

5.4.3.6 Brake cylinder/actuator

The functional specification of the interoperability constituent brake cylinder/actuator is described in 4.2.4.1.2.2 Braking Performance Elements, 4.2.4.1.2.8 Parking Brake, 4.2.4.1.2.5 Energy Limits and 4.2.4.1.2.7 Air Supply.

The specification of the interoperability constituent is described in Annex I section I.5.

5.4.3.7 Pneumatic half coupling

The specification of the interoperability constituent is described in Annex I section I.6.

5.4.3.8 End Cock

The specification of the interoperability constituent is described in Annex I section I.7

5.4.3.9 Isolating device for distributor

The specification of the interoperability constituent is described in Annex I section I.8

5.4.3.10 Brake pad

The specification of the interoperability constituent is described in Annex I section I.9

5.4.3.11 Brake blocks

The specification of the interoperability constituent is described in Annex I section I.10

5.4.3.12 Brake Pipe Emptying Accelerator valve

The specification of the interoperability constituent is described in Annex I section I.11

5.4.3.13 Automatic load sensing & empty/load changeover device

The specification of the interoperability constituent is described in Annex I section I.12

 OTIF	ROLLING STOCK FREIGHT WAGONS		UTP WAG Page 74 of 94	
	Status: ADOPTED	Version: 01	Ref.: A 94-02/3.2011	Original: EN

OTIF UTP

Corresponding text in EU regulations

EU ref.

6. ASSESSMENT OF CONFORMITY AND/OR SUITABILITY FOR USE OF THE CONSTITUENTS AND APPROVAL OF THE SUBSYSTEM

VERIFICATION

NOTE

For a subsystem which is NOT subject to section 7.6.4, the admitting authorities have the obligation to assess, or ascertain through assessments made, that the safe integration of the subsystem in the rail system is ensured and that the essential requirements are also met for those issues where chapter 4 of this UTP prescribes provisions which are indicated with "For wagons subject to section 7.6.4".

6.1 INTEROPERABILITY CONSTITUENTS

6.1.1 ASSESSMENT PROCEDURES

The assessment procedure for conformity or suitability for use of interoperability constituents shall be based on European specifications or specifications approved in accordance with Directive 2001/16/EC.

In the case of suitability for use, these specifications will indicate all the parameters to be measured, monitored or observed, and will describe the related testing methods and measuring procedures, whether in a test-bench simulation or tests in a real railway environment.

The manufacturer of an Interoperability Constituent (IC) or his authorised representative established within the Community shall draw up an EC declaration of conformity or an EC declaration of suitability for use in accordance with Article 13.1 and Annex IV of the Directive 2001/16/EC before placing ICs on the market.

The assessment procedures for conformity of ICs defined in section 5 of this UTP shall be carried out by application of modules as specified in section 6.1.2

TSI

Assessment of conformity or suitability for use of an interoperability constituent (IC) shall be carried out by an assessing entity as defined in UTP GEN-D.

a notified body, when indicated in the procedure, with which the manufacturer or its authorised representative in the Community has lodged the application.

The modules shall be combined and used selectively according to the particular

 OTIF	ROLLING STOCK FREIGHT WAGONS		UTP WAG Page 75 of 94	
	Status: ADOPTED	Version: 01	Ref.: A 94-02/3.2011	Original: EN

OTIF UTP

Corresponding text in EU regulations

EU ref.

constituent.

The modules are defined in general in UTP GEN-D and for specific interoperability constituents in Annex Q of this UTP.²⁴

Annex Q of this TSI.²⁵

The phases for the application of the conformity and suitability for use assessment procedures for the interoperability constituents as defined in section 5 of this UTP are indicated in Annex Q, Table Q.1 to this UTP.

TSI

TSI.

6.1.2 MODULES

6.1.2.1 General

For the conformity assessment procedure of interoperability constituents within the rolling stock subsystem, the manufacturer or his authorised representative established within a Contracting State may choose:

the Community

- a) the "Type-examination" procedure (module CB) for the design and development phase in combination with a module for the production phase: either the "Conformity to type based on quality management system of the production process" procedure (module CD), or the "Conformity to type based on product verification" procedure (module CF),

(module B)

(module D),

(module F),

or alternatively

- b) the "Conformity based on full quality management system plus design examination" procedure (module CH1) for all phases,

(module H2)

or

- c) the "Conformity based on full quality management system" procedure (module CH).

(module H1).

Module CD may only be chosen where the manufacturer operates a quality system for production, final product inspection and testing approved and surveyed by an assessing entity in a Contracting State of its choice.

Module D

a notified body

Assessment of welding processes shall be carried out according to national rules.

For wagons subject to section 7.6.4, EN 15085-5 of October 2007 shall apply.

The open point identified in sections 6.1.2.2 and 6.2.21²⁶ of this TSI is closed with the application of EN 15085-5 of October 2007.

2009/
107/EC
JJ.2,
1.3

Module
CH or CH1

H1 or H2

²⁴ This UTP uses the "new modules" as specified in UTP GEN-D.

²⁵ TSI WAG uses the "old modules" as specified in its Annex Q and Annex AA. These old modules remain in force as specifications for that version of the TSI WAG, until the revised TSI WAG has entered into force.

²⁶ Editorial error in the TSI; should have been 6.1.2.1 and 6.2.2.1

 OTIF	ROLLING STOCK FREIGHT WAGONS		UTP WAG Page 76 of 94	
	Status: ADOPTED	Version: 01	Ref.: A 94-02/3.2011	Original: EN

OTIF UTP

Corresponding text in EU regulations

EU ref.

may only be chosen where the manufacturer operates a quality system for design, production, final product inspection and testing, approved and surveyed by an assessing entity in a Contracting State of the manufacturer's choice.

a notified body of its choice.

Module CH may only be used in accordance with the provisions in section 1.7 of UTP GEN-D (Assessment procedures).

The conformity assessment shall cover the phases and characteristics as indicated by "X" in the Table Q1 of Annex Q to this UTP.

TSI.

6.1.2.2 Existing solutions for Interoperability Constituents

If an existing solution for an interoperability constituent is already on the market in a Contracting State before this

on the European market

UTP

TSI

enters into force, then the following process applies.

The manufacturer shall demonstrate that tests and verification of ICs have been considered successful for previous applications under comparable conditions. In this case these assessments shall remain valid in the new application.²⁷

In this case, the type can be considered as already approved and an assessment of the type is not necessary.

In accordance with assessment procedures for the different ICs, the manufacturer or its authorised representative established within a Contracting State shall:

the Community

- either apply the internal production control procedure (module CA) or (module A)
- or apply the "Internal production control plus product verification by individual examination" procedure (module CA1) or (module A1)
- or apply the "Internal production control plus product verification at random intervals" procedure (module CA2),
- or apply the "Conformity based on full quality management system" procedure (module CH) or (module H1)

If it is not possible to demonstrate that the solution is positively proven in the past, section 6.1.2.1 applies.

Modules CA1, CA2 and CH may only be used in accordance with the provisions in section 1.7 of UTP GEN-D (Assessment procedures).

rev.
TSI
WAG
6.1.2.1
(*)

6.1.2.3 Innovative solutions for Interoperability Constituents

When a solution proposed to be an Interoperability Constituent is innovative, as defined in section 5.2, the manufacturer shall state the deviation from the relevant section of the

UTP.

TSI.

²⁷ In this sentence, "application" means use in a project, thus avoiding duplicate testing.

 OTIF	ROLLING STOCK FREIGHT WAGONS		UTP WAG Page 77 of 94	
	Status: ADOPTED	Version: 01	Ref.: A 94-02/3.2011	Original: EN

OTIF UTP

Corresponding text in EU regulations

EU ref.

The Committee of Technical Experts shall finalise the appropriate functional and interface specifications of the constituents and develop the assessment methods.

The European Railway Agency

The appropriate functional and interface specifications and the assessment methods shall be incorporated in the

UTP

TSI

by the revision process. As soon as these documents are published, the assessment procedure of the interoperability constituents may be chosen by the manufacturer or his authorised representative established within a Contracting State as specified in section 6.1.2.1.

the Community

After entry into force of a decision of the Committee of Technical Experts,

Commission, taken in accordance with Article 21(2) of Directive 2001/16/EC,

the innovative solution may be used before being incorporated into the UTP.

TSI.

6.1.2.4 Assessment of suitability for use

Whenever an assessment procedure is started based on in-service experience for an interoperability constituent within the rolling stock subsystem, the manufacturer or his authorised representative established within a Contracting State shall apply the "Type validation by in-service experience (suitability for use)" procedure (module CV).

the Community

(module V)

If module CV is used, it shall be in combination with one of the following three (combinations of) modules: CB+CD or CB+CF or CH1.

6.1.3 SPECIFICATION FOR ASSESSMENT OF ICS

6.1.3.1 Structures and mechanical parts

6.1.3.1.1 Buffers

The buffers are to be assessed against the specification contained in section 4.2.2.1.2.1 buffers paragraph buffer characteristics.

6.1.3.1.2 Draw Gear

The draw gear shall be assessed against the specification contained in section 4.2.2.1.2.2 draw gear, paragraph "draw gear characteristics" and section 4.2.2.1.2.3 interaction of draw- and buffing-gear, paragraph "draw gear and buffing gear characteristics".

6.1.3.1.3 Marking of Freight Wagons

The decals for marking are to be assessed against the specification contained in Annex B.

6.1.3.2 Vehicle track interaction and gauging

6.1.3.2.1 Bogie and Running Gear

The integrity of the structure of the body to bogie connection, bogie frame, axle-box and all attached equipment shall be assured. This assurance shall be generated by use of sufficient appropriate methods, such as demonstration by bench tests, validated modelling, comparison with an existing design approved by or on behalf of national approval regime, which is used in similar service and condition or other methods.

 OTIF	ROLLING STOCK FREIGHT WAGONS		UTP WAG Page 78 of 94	
	Status: ADOPTED	Version: 01	Ref.: A 94-02/3.2011	Original: EN

OTIF UTP

| Corresponding text in EU regulations

EU ref.

The test conditions applicable for bogies running on standard gauge track under normal conditions of speed and track quality are defined in Annex J. They represent only the common part of the full range of tests to be performed on all types of bogie frames.

It is not possible to specify tests of a general nature for each specific bogie component, in particular for the axle bearings, the connection between bogie and body, the dampers and the brakes. Such tests shall be drawn up case by case, using the tests defined above as a guide. The objectives and the parameter definitions of the tests already specified are detailed below.

This remark also applies to the case of bogie frames intended for service on track with a different gauge, or under clearly different operating conditions, or bogies with a novel design.

The three tests described in Annex J sections J.1, J.2 and J.3 have been defined in order to:

- optimise the construction of the bogie frame (weight, speed),
- supplement the information obtained from calculations,
- ensure that the bogie frames are suitable for withstanding the in-service loads without the occurrence of permanent deformation or cracks that would reduce safety or result in high maintenance costs.

If there is no comparable solution available, experience has shown that three tests are required: two static tests (Annex J sections J.1 and J.2), and one dynamic test (Annex J section J.3).

The two static tests shall be performed first; they allow, in particular, for any bogies that do not meet the minimum strength requirements to be rejected.

The dynamic test (fatigue test) is designed to verify whether the bogie design is sound, and whether fatigue cracks might be expected to occur in service.

The load values that have been used for the definition of the tests have been derived in particular from running tests.

The tests in Annex J section J.1 are considered to represent the maximum loads that can occur in service, without taking the loads due to accidents into account.

The tests in Annex J sections J.2 and J.3 are considered to represent, on average, the aggregate total of variable loads occurring during the bogie service life.

The number of cycles in the fatigue test was selected to simulate an overall service life of 30 years at a rate of 100 000 km per year. If this is not representative of the intended life cycle, the load cases shall be revised.

The distribution of these cycles over three distinct load stages was done with a view to optimising bogie frame structures. In particular, the possibility of the occurrence of cracks during the last load stage provides a means to identify the most highly stressed zones, to which special attention shall be paid during manufacture, production testing and maintenance operations.

To ensure the validity of the tests defined in Annex J sections J.1, J.2 and J.3, particular attention shall be paid to their practical implementation. In particular: -

For the static tests of Annex J sections J.1 and J.2, the bogie frames shall be equipped with uni-directional strain gauges in those locations where stresses occur with a single clearly defined direction; in all other locations tridirectional strain gauges (rosettes) shall be used.

The active part of these gauges shall not exceed 10 mm.

Strain gauges and strain rosettes are attached to the bogie frame at all highly stressed points, in particular in zones of stress concentration.

 OTIF	ROLLING STOCK FREIGHT WAGONS			UTP WAG Page 79 of 94
	Status: ADOPTED	Version: 01	Ref.: A 94-02/3.2011	Original: EN

OTIF UTP

Corresponding text in EU regulations

EU ref.

The test set-up shall be defined so as to reproduce the forces acting on the bogie frame, and its deformation, as they occur in service. Particular attention shall be paid to the transmission of the vertical and transverse loads that in certain cases are distributed over several elements (e.g. pivot, springs, stops...).

The static tests shall be performed on a complete bogie, equipped with its suspension. In most cases, this arrangement is not feasible for the fatigue test for practical reasons; a separate study shall be conducted to define the test set-up.

The bogie frames used for the three tests shall be complete, and equipped with all their connecting elements (for dampers, brakes, etc.). They shall conform fully to the production drawings, and they shall have been manufactured under the same conditions as series-produced bogie frames.

If cracks or fractures occur during the fatigue test, originating from manufacturing defects that were not detected during the preceding static testing of the bogie frame, the test shall be repeated with another frame. If the defects are confirmed, the design shall be considered as unsatisfactory.

6.1.3.2.2 Wheelsets

The assessment of the wheelset is described in Annex K.

6.1.3.2.3 Wheels

The assessment of the design and of the product is described in Annex M.

6.1.3.2.4 Axle

The assessment of the design and of the product is described in Annex M.

6.1.3.3 Braking

See Annex P.

6.2 SUBSYSTEM CONVENTIONAL RAIL ROLLING STOCK FREIGHT WAGONS

6.2.1 ASSESSMENT PROCEDURES

If the applicant for the technical admission

At the request of the contracting entity or its representative established in the Community, the notified body carries out EC verification in accordance with annex VI of the Directive 2001/16/EC.

If the contracting entity

can demonstrate that tests or verifications related to the Conventional Rail Rolling Stock Subsystem have been considered successfully for any previous application, these assessments shall be taken into account in the conformity assessment.

Modified freight wagons changed within the limits given in Annex II shall not require a new conformity assessment.

The impact of weight change on safety critical components, safety related components, the interaction between infrastructure and the freight wagon, and on classification for line categories according to 4.2.3.2, must in all cases be considered.

As far as specified in this

UTP, the technical admission of freight wagons shall take into account its interfaces with other subsystems of the Conventional Rail System.

TSI, the EC verification of the Conventional Rail Rolling Stock Subsystem

Assessment of conformity of the subsystem | The contracting entity shall draw up the



OTIF UTP

tem shall be carried out and evidenced through an "Assessment Report" by the authority competent for technical admission or a suitable body as defined in Article 5 of ATMF in the Contracting State with which the application has been lodged.

If conformity is proven, the authority or the suitable body shall, in accordance with Article 10 of ATMF, draw up a dated and signed "Certificate of Operation" or a "Design Type Certificate" in one of the Organisation's working languages with the content specified in Article 11 of ATMF.

Corresponding text in EU regulations

EU ref.

EC declaration of verification for the Rolling Stock Subsystem in accordance with Article 18 (1) and Annex V of Directive 2001/16/EC.

6.2.2 MODULES

6.2.2.1 General

The Modules to choose

to assess that a subsystem freight wagon complies with the applicable regulations are defined in UTP GEN-D.²⁸

for the verification procedures are defined in Annex AA.²⁹

For the assessment of conformity with the requirements for freight wagons, as specified in section 4, the applicant

For the verification procedure of the contracting entity or its authorised representative established within the Community

may chose the following modules:

- a) the "Type Examination" procedure (module SB) for the design and development phase, in combination with a module for the production phase either:
 - the "Quality Management System of the production process" procedure (module SD),
 - or the "Product Verification" procedure (module SF);

or

- b) the "Full quality Management System with Design Examination" procedure (module SH1). | (module SH2)

The module SD may only be chosen where the applicant,

contracting entity,

or the main contractors when involved, operate a quality management system for manufacture, final production, inspection and testing, approved and surveyed by an assessing entity of his/their choice.

| a Notified Body of his/their choice.

Assessment of welding processes shall be carried out according to national rules. Alternatively EN 15085-5 of October 2007 may be used, in which case this is not an open point.

The open point identified in sections 6.1.2.2 and 6.2.21³⁰ of this TSI is closed with the application of EN 15085-5 of October 2007.

2009/107/EC JJ.2, 1.3

The module

²⁸ This UTP uses the "new modules" as specified in UTP GEN-D.

²⁹ TSI WAG uses the "old modules" as specified in its Annex AA. These old modules remain in force as specifications for this version of the TSI WAG.

³⁰ Editorial error in the TSI; should have been 6.1.2.1 and 6.2.2.1

 OTIF	ROLLING STOCK FREIGHT WAGONS		UTP WAG Page 81 of 94	
	Status: ADOPTED	Version: 01	Ref.: A 94-02/3.2011	Original: EN

OTIF UTP

SH1

may only be chosen where the applicant

or the main contractors when involved, operate a quality management system for design, manufacture, final production inspection and testing, approved and surveyed by

an assessing entity of his/their choice.

Corresponding text in EU regulations

EU ref.

SH2

contracting entity,

a Notified Body of his/their choice.

The following additional requirements shall be taken into account for the use of the modules:

- Module SB: with reference to section 4.3 of the module, a design review is requested,
- For the production phase, modules SD, SF and SH1: SH2: the application of these Modules shall enable the conformity of the wagons with the approved type as described in the type examination certificate. In particular, the application shall demonstrate that the manufacture and the assembly are realised with the same components and the same technical solutions as the approved type.

The provisions in Annex PP (Vehicle identification) shall not be subject to assessment by the assessing entity as part of the Modules, but in accordance with ATMF Article 14, before granting the admission the admitting authority shall ascertain that the provisions of Annex PP have been met.

6.2.2.2 Innovative solutions

When a freight wagon includes an innovative solution, as defined in section 4.1, the manufacturer or the applicant

shall state the deviation from the relevant section of the

UTP. The Committee of Technical Experts

shall finalise the appropriate functional and interface specifications of this solution and develop the assessment methods.

The appropriate functional and interface specifications and assessment methods shall be incorporated in the

UTP

by the revision process.

As soon as these documents are published, the assessment procedure for the freight wagon may be chosen by the applicant

as specified in the section. 6.2.2.1.

After entry into force of a decision of the Committee of Technical Experts,

the innovative solution may be used before UTP.

contracting entity

TSI. The European Railway Agency

TSI

the manufacturer or the contracting entity or his authorised representative established within the Community,

Commission, taken in accordance with Article 21(2) of Directive 2001/16/EC,

TSI.

6.2.2.3 Assessment of Maintenance

According to UTP GEN-D, the assessing entity shall compile the Technical File,

According to article 18.3 of the Directive 2001/16/EC, the Notified Body shall

 OTIF	ROLLING STOCK FREIGHT WAGONS		UTP WAG Page 82 of 94	
	Status: ADOPTED	Version: 01	Ref.: A 94-02/3.2011	Original: EN

OTIF UTP

Corresponding text in EU regulations
compile the Technical File,

EU ref.

which includes the Maintenance File.

The conformity assessment of maintenance is in the responsibility of each Contracting State
concerned.

Member State

For wagons subject to section 7.6.4, any maintenance file which:

2009/
107/EC
JJ.2,
1.4

a) was applied by a former registering Railway Undertaking (RU) member of RIV at the time of the revocation of RIV, or

b) was approved in accordance with a national or international rule

and which also complies with the requirements of this UTP
is valid.

TSI

The in-service performances are considered as satisfactory.

For wagons not subject to section 7.6.4,
this point is an open point, cf. Annex JJ.

6.2.3 SPECIFICATIONS FOR ASSESSMENT OF THE SUBSYSTEM

6.2.3.1 Structures and Mechanical Parts

6.2.3.1.1 Strength of main vehicle structure and Securing of Freight

Validation of the design shall follow the requirements of section 6 of EN12663.

The test programme shall include a shunting impact test as defined in Annex Z if no demonstration of structural integrity by calculation has been performed.

Where tests have previously been carried out on similar components or sub-systems it is not necessary to repeat the tests, provided a clear safety justification showing the applicability of the earlier tests can be provided.

6.2.3.2 Vehicle track interaction and gauging

6.2.3.2.1 Vehicle dynamic behaviour

6.2.3.2.1.1 Application of the partial type approval procedure

When a wagon has already been type approved, modifications of certain of its characteristics (see section 4.2.3.4.1) or of the conditions of its operation that affect its dynamic behaviour may require an additional test.

6.2.3.2.1.2 Certification of new wagons

When new wagons have to be approved by commissioning tests, these tests shall be done by:

- 1) measurement of wheel/rail forces
or
- 2) measurement of accelerations
or
- 3) validated modelling
or
- 4) comparison with existing vehicles

The precise limit values will vary according to the testing and analysis method used.

6.2.3.2.1.3 Exemptions from dynamic behaviour test for wagons to built or converted to run up to 100 km/h or 120 km/h

Freight wagons are permitted to run up to 100 km/h or 120 km/h without having to pass the dynamic behaviour test if they meet the following conditions defined in

 OTIF	ROLLING STOCK FREIGHT WAGONS		UTP WAG Page 83 of 94	
	Status: ADOPTED	Version: 01	Ref.: A 94-02/3.2011	Original: EN

OTIF UTP

| Corresponding text in EU regulations

EU ref.

- Longitudinal Compression Forces 4.2.3.5
- Static axle load, dynamic wheel load and linear load 4.2.3.2

and if they are fitted with a suspension or bogie listed below.

Two axle wagons

Freight wagons shall be fitted with type of suspensions listed in Annex Y in the table relating to two axle wagons.

Wagons with two-axle bogies

The freight wagons shall be fitted with types of bogies or variants provided that the modifications with respect to the basic type only affect elements that cannot influence the dynamic behaviour. These bogies are listed in Annex Y in the two tables relating to wagons with two axle bogies.

Wagons with three-axle bogies

The freight wagons shall be fitted with types of bogies or variants provided that the modifications with respect to the basic type only affect elements, which cannot influence the dynamic behaviour. These bogies are listed in Annex Y in the table relating to wagons with three axle bogies. .

6.2.3.2.1.4 Exemptions from stationary tests (d)

Freight wagons are exempted from the stationary tests mentioned in section 4.2.3.4.2.1 if they comply with the requirements of UIC leaflet 530-2 (May 2006).

6.2.3.2.2 Longitudinal compressive forces for freight wagons with side buffers

When it is necessary to require the certification of the admissible longitudinal compressive force by tests, then the tests have to be carried out according to the method described in Annex R, at least with the measurement areas given in Annex R. | this Annex.

6.2.3.2.3 Measuring the freight wagons

Evidence shall be provided by measuring the freight wagon underframes and bogies that deviations from the nominal dimensions are within the permissible tolerances (EN 13775 part 1 to 3 and prEN 13775 parts 4 to 6).

6.2.3.3 Braking

6.2.3.3.1 Braking performance

The methods to determine the braking power are described in Annex S.

6.2.3.3.2 Minimum Brake System Testing

The tests and limits below apply to wagons fitted with conventional air brakes for freight trains.

These tests shall be performed only with the single pipe mode (the Brake Pipe).

Tests with the auxiliary reservoir filled permanently from the Main Reservoir Pipe shall also be carried out to demonstrate that the brake operation is not adversely affected.

The normal working pressure (regime pressure) of the conventional air brake is 5 bar.

These tests shall be performed at this pressure. Additionally sample tests shall be performed to ensure that the operation of the brake is not adversely affected, with a decrease or an increase in this working pressure not exceeding 1 bar.

The tests shall be performed in the “P” and “G” brake modes, when fitted. Where variable or empty load braking systems are fitted, the tests shall be carried out in the “loaded” and “empty” positions to ensure that the operation of the brake is not

 OTIF	ROLLING STOCK FREIGHT WAGONS		UTP WAG Page 84 of 94	
	Status: ADOPTED	Version: 01	Ref.: A 94-02/3.2011	Original: EN

OTIF UTP

Corresponding text in EU regulations

EU ref.

adversely affected and is compliant with this UTP.

TSI.

The use of electricity or other means to control the brake is permitted provided the principles of this UTP.

TSI.

are retained. The equivalent level of safety shall be demonstrated.

Tests listed in the table below are done based on a separate vehicle when stationary or on a stationary train.

Individual Interoperability Constituents have their design and product assessment described within Annex P.

Pneumatic Brake Characteristics

No	Characteristic	Limit Value
1	Fill time of the brake cylinder to 95 % maximum pressure	<u>P Setting</u> 3-5 seconds (3-6 seconds in the case of an empty/load system) <u>G Setting</u> 18-30 seconds
2	Release time of the brake cylinder to 0.4 bar pressure	<u>P Setting</u> 15-20 seconds For a total weight of 70 tonnes or greater, it is permissible for the release time to be 15 to 25 seconds. <u>G Setting</u> 45-60 seconds In the case of brakes with pneumatically controlled devices for the variation of the braking power, the release time is the time which must elapse before a pressure of 0.4 bar is seen in the relay control chamber (pilot pressure)
3	Reduction in brake pipe pressure required to obtain maximum brake cylinder pressure	1.5±0.1 bar
4	Maximum brake cylinder pressure	3.8±0.1 bar
5	Sensitivity/Insensitivity The insensitivity of the brake to slow decreases in brake pipe pressure shall be such that the brake is not activated if the normal working pressure drops by 0.3 bar in one minute. The sensitivity of the brake to decreases in brake pipe pressure shall be such that the brake is activated within 1.2 seconds if the normal working pressure drops by 0.6 bar in 6 seconds.	Brake does not activate with a 0.3 bar drop in one minute. Brake activates within 1.2 seconds with a 0.6 bar drop in 6 seconds.
6	Brake pipe leakage from a starting pressure of 5 bar	0.2 bar maximum pressure loss in 5 minutes



OTIF UTP

Corresponding text in EU regulations

EU ref.

No	Characteristic	Limit Value
7	Brake cylinder, auxiliary reservoir and control reservoir leakage from a starting brake cylinder pressure of 3.8 + or – 0.1 bar from a brake pipe pressure of 0 bar	0.15 bar maximum pressure loss in 5 minutes measured at the auxiliary reservoir.
8	Manual release of the automatic air brake.	Brake releases
9	Graduability in application and release variations in brake pipe pressure:	Less or equal to 0.1 bar.
10	Pressure corresponding to the return to the filling position at the time of brake release	Brake Pipe : 0.15 bar below actual running pressure Brake cylinder : < 0.3 bar
11	Automatic air brake indicator	Ensure the indicator reflects the brake state – applied or released
12	Slack adjuster to be tested by creating an excessive brake friction pair gap and demonstrating that repeated application/release cycles restore correct clearance	Design brake friction pair pad/block clearance
13	Compliance to design brake pad/block loads	Brake pad/block loads shall comply with design
14	Brake rigging shall be free to move and allow brake pads/blocks to clear the brake discs/wheels in the released state and not reduce application forces below design	Brake rigging shall be free
15	Parking brake components shall be free moving and lubricated if required	Free movement: ensure that it applies and releases without binding.
16	Control and performance of the parking brake shall be such that with 500 N force applied to the end of a brake lever or tangentially to a hand wheel rim, the parking brake is fully applied	500 N input force
17	Manual release of the parking brake	Parking Brake releases
18	Parking brake indicator shall reflect state of brake	Indicator shall accurately show the brake state – applied or released

Notes on Table above:

N1. The timings shall be obtained from an emergency application on a single vehicle. Following inshot to approximately 10 % of the final brake cylinder pressure, the increase in pressure shall be progressive. The filling time begins when air commences to fill the cylinder and ends when the pressure reaches 95 % of the final value, and shall be as stated.

 OTIF	ROLLING STOCK FREIGHT WAGONS		UTP WAG Page 86 of 94	
	Status: ADOPTED	Version: 01	Ref.: A 94-02/3.2011	Original: EN

OTIF UTP

| Corresponding text in EU regulations

EU ref.

N2. At the time of full and continuous release of the brake on a separate vehicle following an emergency application, the pressure in the brake cylinder shall fall progressively. The release time, measured from when air commences to be exhausted from the cylinder, to when the pressure reaches 0.4 bar shall be as stated.

N3. In order to obtain maximum brake cylinder pressure, the brake pipe pressure shall be reduced by 1.4 to 1.6 bar below the regime pressure.

N4. The maximum brake cylinder pressure obtained from a reduction in brake pipe pressure of 1.4 to 1.6 bar shall be 3.7 to 3.9 bar.

N5. The insensitivity of the brake to slow decreases in brake pipe pressure shall be such that the brake is not activated if the normal working pressure drops by 0.3 bar in one minute.

The sensitivity of the brake to decreases in brake pipe pressure shall be such that the brake is activated within 1.2 seconds if the normal working pressure drops by 0.6 bar in 6 seconds.

N6. After charging the brake pipe to 5 bar, isolate the brake pipe, allow time for settlement and then ensure leakage does not exceed that stated.

N7. After an emergency braking, with a brake pipe pressure of 0 bar, start measuring after the stabilisation period and ensure overall leakage does not exceed that stated.

N8. The brake shall have a device enabling manual brake release.

N9. The brake shall be such that the pressure in the brake cylinder continuously follows the variations in the brake pipe pressure. A pressure variation of +/- 0.1 bar in the brake pipe shall cause the distributor to change the brake cylinder pressure correspondingly.

For one value of brake pipe pressure, the brake cylinder pressure shall not vary by more than 0.1 bar during application and release. (For braking via pneumatically controlled relay valves for braking power variation, the 0.1 bar value applies to the pilot pressure.)

N10. In the case of brakes with relay valves for the variation of the braking power, the pressure of 0.3 bar corresponds to the pressure existing at the pneumatic relay control (pilot reservoir).

N11. Wagons where the automatic air brake application/release state cannot be checked without going underneath the wagon (for example those fitted with axle mounted disc brakes) shall be fitted with an indicator showing the state of the automatic brake.

N12. Correct slack adjuster operation shall be confirmed by creating an excessive brake friction pair gap, demonstrating that repeated application/release cycles restore the correct clearance.

N13. On the first of a series of wagons, the brake pad or block application force shall be measured to confirm that it complies with the design.

N14. Brake rigging shall be free such that the pads/blocks clear the brake discs/wheels in the released state, and application forces are not reduced below design.

N15. Parking brake components, rigging, leadscrews & nuts etc, shall be free moving and lubricated if required by the design.

N16. On the first of a series of wagons, the vehicle retarding force shall be measured resulting from a 500 N input force at the end of a parking brake lever, or applied tangentially to a handwheel rim. The force measured shall comply with the design.

N17. The parking brake shall be applied and released manually, not adversely affecting the friction pair gap in the released state.

 OTIF	ROLLING STOCK FREIGHT WAGONS			UTP WAG Page 87 of 94
	Status: ADOPTED	Version: 01	Ref.: A 94-02/3.2011	Original: EN

OTIF UTP

| Corresponding text in EU regulations

EU ref.

N18. A parking brake indicator shall be fitted which accurately reflects the status of the parking brake, applied or released.

The tests procedures shall conform to the European standards.

For freight wagons equipped with "R" braking mode specific tests shall be done. These tests shall conform to the European standards.

6.2.3.4 Environmental conditions

6.2.3.4.1 Temperature and other environmental conditions

6.2.3.4.1.1 Temperature

All components and groups of components have to be tested in accordance with requirements given in section 4.2 and 6 and referenced European Standards, taken into account which temperature class specified in section 4.2.6.1.2.2 the wagon shall be approved for.

6.2.3.4.1.2 Other environmental conditions

It is sufficient for the supplier to make a declaration of conformity stating how the environmental conditions in the following sections have been taken into account in the design of the wagon:

- 4.2.6.1.2.1 (Altitude)
- 4.2.6.1.2.3 (Humidity)
- 4.2.6.1.2.5 (Rain)
- 4.2.6.1.2.6 (Snow, ice and hail)
- 4.2.6.1.2.7 (Solar radiation)
- 4.2.6.1.2.8 (Resistance to pollution)

The assessing entity | The notified body
shall verify that this declaration exists and that the content is reasonable.

This does not affect specific test requirements regarding environmental conditions given in section 4 or 6. They shall be executed and verified. Those tests shall be referenced in the declaration.

6.2.3.4.2 Aerodynamic effects

Open point to be specified at the next revision of this UTP. This open point shall be considered | TSI.
as NOT related to the compatibility with |
infrastructure, see Annex JJ.

rev.
Annex
JJ.1

6.2.3.4.2 Cross winds

Not to be assessed for the wagon construction.

 OTIF	ROLLING STOCK FREIGHT WAGONS		UTP WAG Page 88 of 94	
	Status: ADOPTED	Version: 01	Ref.: A 94-02/3.2011	Original: EN

OTIF UTP

| Corresponding text in EU regulations

EU ref.

7. IMPLEMENTATION

7.1 GENERAL

The implementation of the UTP must take into consideration the overall migration of the conventional rail network towards full interoperability.

| TSI

In order to support this migration, the UTPs allow for staged, gradual application and UTPs

| TSIs

| TSIs

In the case of this UTP it shall be implemented in close co-ordination with the UTP Noise.

| TSI

| Noise TSI.

7.2 UTP REVISION

The Committee of Technical Experts will review and update this and related UTPs

TSI REVISION

In conformity with article 6(3) of Directive 2001/16/EC as modified by Directive 2004/50/EC, the Agency shall be responsible for preparing the review and updating of TSIs and making appropriate recommendations to the Committee referred to in Article 21 of this directive

in order to take account of developments in technology or social requirements. In addition, the progressive adoption and revision of other UTPs

| TSIs

may also impact this UTP.

| TSI.

Proposed changes to this UTP shall be subject to rigorous review and updated UTPs will be published on an indicative periodic basis of 3 years.

| TSI

| TSIs

The Secretary General shall be notified of any innovative solutions under consideration in order to determine its future inclusion within the UTP.

| The Agency

| TSI.

7.3 APPLICATION OF THIS UTP TO NEW ROLLING STOCK

| TSI

Sections 2 to 6 and any specific provisions in paragraph 7.7 below apply in full to new freight wagons being technically admitted, with the following exceptions:

| placed into service,

- the provisions of section 4.2.4.1.2.2 (Braking Performance elements) deceleration profile in braking power, for which a date of implementation will be given in future revisions of the UTP.

| TSI.

 OTIF	ROLLING STOCK FREIGHT WAGONS		UTP WAG Page 89 of 94	
	Status: ADOPTED	Version: 01	Ref.: A 94-02/3.2011	Original: EN

OTIF UTP | Corresponding text in EU regulations | EU ref.

This UTP does not apply to wagons being subject to a contract already signed or under final phase of tendering procedure before the date of entry into force of this UTP. | TSI | TSI.

7.4 EXISTING ROLLING STOCK

7.4.1 APPLICATION OF THIS UTP TO EXISTING ROLLING STOCK | TSI

Existing freight wagons are freight wagons that are already in service before this UTP enters into force: | TSI

This UTP does not apply to existing rolling stock subject to ATMF Article 19, except the provisions in section 4.2.2.5, which do apply. See also 7.4.3. | TSI | as long as it is not renewed or upgraded.

7.4.2 UPGRADING AND RENEWAL OF EXISTING FREIGHT WAGONS

Upgraded or renewed freight wagons requiring new authorisation for placing into service

according to Article 19 of ATMF | within the meaning of Directive 2001/16/EC Article 14.3,

shall comply with:

- sections 4.2, 5.3, 6.1.1 and 6.2 and any specific provisions in paragraph 7.7 below, as soon as this UTP comes into force; | TSI

The following exceptions shall apply:

- 4.2.4.1.2.2 Deceleration profile in braking power;
- 4.2.6 Environmental conditions;
- 4.2.6.2 Aerodynamic effects (T be specified at the next revision of this UTP); | TSI);
- 4.2.8 Maintenance file.

For these exceptions, national rules apply.

With regards to wagons operating under the agreements specified in 7.5 below, the conditions to be applied when renewing or upgrading these wagons are those mentioned in the relevant agreements, if any. In the absence of such conditions, this UTP is applicable. | TSI

7.4.3 ADDITIONAL REQUIREMENTS FOR WAGON MARKING

In addition to the general case above for upgraded or renewed freight wagons, all existing interoperable³¹ freight wagons are required to comply with the requirements of this

³¹ i.e. subject to ATMF Article 19.

 OTIF	ROLLING STOCK FREIGHT WAGONS		UTP WAG Page 90 of 94	
	Status: ADOPTED	Version: 01	Ref.: A 94-02/3.2011	Original: EN

OTIF UTP

UTP
with respect to the

wagon markings from the date of the next intervention of an assessing entity.

A Contracting State is permitted to define an earlier date of compliance.

Existing markings on a wagon of (almost) the same shape, dimensions, colour, position and content as indicated in Annex B (or EN 15877-1:2012) may remain as they are.

Corresponding text in EU regulations

EU ref.

TSI

design of

overall repainting of the wagon without the

a Notified Body.

A Member State

7.5 WAGONS OPERATING UNDER NATIONAL, BILATERAL, MULTILATERAL OR INTERNATIONAL AGREEMENTS

7.5.1 EXISTING AGREEMENTS

Within 6 months after the entry into force of this UTP, Contracting States shall notify the Organisation of all bilateral or multilateral agreements in force for wagons not marked RIV in order that wagons subject to those agreements may also be subject to Article 19 § 2a of ATMF and will not therefore require a new admission to operate on the networks covered by the (bilateral or multilateral) agreement.

Member States shall notify the Commission, within 6 months after the entry into force of this TSI, of the following agreements under which freight wagons related to the scope of this TSI (construction, renewal, upgrading, placing in service, operation and management of wagons as defined in chapter 2 of this TSI) are operated:

- National, bilateral or multilateral agreements between Member States and Railway Undertakings or Infrastructure Managers, agreed on either a permanent or temporary basis, and required due to the very specific or local nature of the intended transport service;
- bilateral or multilateral agreements between Railway Undertakings, Infrastructure Managers or between Safety Authorities, which deliver significant levels of local or regional interoperability;
- international agreements between one or more Member States and at least one third country, or between Railway Undertakings or Infrastructure managers of Member States and at least one Railway Undertaking or Infrastructure Manager of a third country, which deliver significant levels of local or regional interoperability.

Continued operation/maintenance of wagons covered by these agreements shall be permitted as far as they do comply with Community legislation.

 OTIF	ROLLING STOCK FREIGHT WAGONS		UTP WAG Page 91 of 94	
	Status: ADOPTED	Version: 01	Ref.: A 94-02/3.2011	Original: EN

OTIF UTP

Corresponding text in EU regulations

EU ref.

The compatibility of these agreements with EU legislation including their nondiscriminatory character and, in particular, this TSI, will be assessed and the Commission will take the necessary measures such as, for example, the revision of this TSI to include possible specific cases or transitional measures.

The RIV Agreement and COTIF instruments shall not be notified.

7.5.2 FUTURE AGREEMENTS

Any future agreement or modification of existing agreements shall take into account COTIF regulations

and, in particular this

UTP

as far as applicable,

Before their conclusion, Contracting States shall notify the Organisation of such agreements/modifications.

The Committee of Technical Experts will examine their compatibility with COTIF regulations, including this UTP, and will include, for example, possible specific cases or transitional measures the next time this UTP is revised.

EU legislation

TSI.

Member States shall notify the Commission with

The same procedure of § 7.5.1 then applies.

7.6 TECHNICAL ADMISSION OF UTP CONFORM FREIGHT WAGONS

PLACING IN SERVICE OF TSI CONFORM WAGONS

Decision
2009/
107/EC

7.6.1 The technical admission shall be carried out and mutually recognised in accordance with ATMF.

In accordance with Article 17(1) of Directive 2008/57/EC, where compliance with the TSIs has been achieved and an EC Declaration of Verification is issued within one Member State for freight wagons, this shall be mutually recognised by all Member States.

7.6.2 (Reserved)

When seeking authorisations of placing in service under Article 21 of Directive 2008/57/EC, applicants may seek authorisations for placing in service of grouped wagons. Wagons may be grouped according to series, in which case Article 21(13) of Directive 2008/57/EC applies, or according to type, in which case Article 26 of that Directive applies.

7.6.3 (Reserved)

In accordance with Article 21(5) of Directive 2008/57/EC, the authorisation for placing in service granted by one Member State shall be valid in all Member States unless additional authorisations are requested. However Member States may use this possibility only under the condi-

 OTIF	ROLLING STOCK FREIGHT WAGONS		UTP WAG Page 92 of 94	
	Status: ADOPTED	Version: 01	Ref.: A 94-02/3.2011	Original: EN

OTIF UTP

Corresponding text in EU regulations EU ref.

7.6.4

A technical certificate issued by one Contracting State for a freight wagon which is not subject to a specific case or a derogation shall be deemed to meet the conditions of ATMF Article 3 § 3 provided all the following conditions are met:

(a) the wagon has been admitted

on the basis of this UTP,

including the verifications related to the applicable open points identified in Annex JJ section JJ.1

tions specified in Articles 23 and 25 of that Directive. In accordance with Article 23(4) of that Directive, one of the conditions allowing a Member State to request for an “additional authorisation” procedure is the case of open points related to technical compatibility between infrastructure and vehicles. To this end, Annex JJ sets out the list of open points as requested in Article 5(6) of that Directive and also identify those open points that may require additional checks with a view to ensuring technical compatibility between infrastructure and vehicles.

An authorisation of placing in service granted by one Member State shall be valid in all other Member States under the following conditions:

authorised in accordance with Article 22 of Directive 2008/57/EC,

TSI,

applicable open points identified in Annex JJ part 1;

(b) the wagon is compatible with the 1435 mm track gauge;

(c) the wagon has a G1³² loading gauge, as specified in section C.3 of Annex C;

(d) the wagon is equipped with an axle distance that does not exceed 17 500 mm between two adjacent axles;

(e) the wagon complies with the additional technical requirements in chapters 4, 5 and 6, which are indicated as applicable if the wagon is “subject to section 7.6.4”³³

requirements of Annex JJ part 2.

7.6.5

Even if a wagon has been admitted to operation (i.e. has a valid Certificate of Operation), there is a need to ensure that it is operated

authorised for placing in service,

(only) on compatible infrastructures;

this may be done through the use of Infrastructure and Rolling Stock registers.

7.7

SPECIFIC CASES

Specific cases for Contracting States which are EU Member States shall be included in this UTP as they appear in TSI WAG.

³² To be understood as profile G1 and G11 according to EN 15273-2:2009

³³ The requirements of TSI Annex JJ part 2 have all been integrated in chapters 4, 5 and 6 of this UTP WAG. These additional provisions may be found in 4.2.2.1.2.1, 4.2.2.1.2.2, 4.2.2.3.1, 4.2.2.3.2.4, 4.2.3.3.2, 4.2.3.3.3, 4.2.3.4, 4.2.3.2.2.2, 4.2.3.4.2.4, 4.2.3.5, 4.2.4.1.2.4, (4.2.6.3), 4.2.9.1, 4.3.2.3.1, 6.1.2.1, 5.4.2.4, 6.2.2.3, Annex E table E.1, Annex P1.10 and P2.10.

 OTIF	ROLLING STOCK FREIGHT WAGONS		UTP WAG Page 93 of 94	
	Status: ADOPTED	Version: 01	Ref.: A 94-02/3.2011	Original: EN

OTIF UTP

Specific cases for Contracting States which are not Member States of the European Union will be included in this UTP when they have been evaluated and adopted by the Committee of Technical Experts.

Corresponding text in EU regulations

EU ref.

7.7.1 Introduction

The following special provisions are permitted in the specific cases below.

These specific cases belong to two categories: the provisions apply either permanently (case "P"), or temporarily (case "T"). In temporary cases, it is recommended that the

Contracting States

(case "T1") concerned should conform with

and by 2020
(case "T2").

Member States

the relevant subsystem

either by 2010, an objective set out in Decision No 1692/96/ EC of the European Parliament and of the Council of 23 July 1996 on Community guidelines for the development of the trans-European transport network,
or by 2020

Specific cases included in TSI WAG:

Ad 4.3.2.1.1 Vehicle mass

Specific case Austria, Germany, Sweden and Belgium:

The axle load shall be at least 5 t on certain lines specified in the infrastructure register.

Ad 4.3.2.1.2 Axle distances

Specific case Germany:

Limitations on the relationship between axle distance (a_i) and wheel diameter are still to be defined.

- Open point -

Specific case Poland and Belgium:

The distance b_x [Fig. 6] shall not exceed 3500 mm.

Specific case Germany:

The distance a_i [Fig. 6] between each of the first 5 axles of a train (or all axles if the train has less than 5) shall not be less than 1000 mm if speed does not exceed 140 km/h; for higher speeds the Article [2.1.3] applies.

Specific case France high Speed TEN and Belgium high speed TEN "L1" only:
NOT RELEVANT for freight wagons

Specific case Belgium:

The distance $L - (b_1 + b_2)$ [Fig. 6] shall not be less than 6000 mm

CCS
2006/679/
EC

Annex A,
Appen-
dix 1

3.1.3

2.1.5

2.1.6

2.1.7

2.1.8

2.1.9

 OTIF	ROLLING STOCK FREIGHT WAGONS		UTP WAG Page 94 of 94	
	Status: ADOPTED	Version: 01	Ref.: A 94-02/3.2011	Original: EN

OTIF UTP

Corresponding text in EU regulations EU ref.

ad point 4.3.2.3.2 Impedance between wheels 3.5.3

Specific case Poland:

The reactance between running surfaces of a wheelset shall be less than $f/100$ in milliohms when f is between 500 Hz and 40 kHz, under a measuring current of at least $10 A_{RMS}$ and open voltage of $2 V_{RMS}$.

Specific case France:

The reactance between running surfaces of a wheelset shall be less than $f/100$ in milliohms when f is between 500 Hz and 10 kHz, under a measuring voltage of $2 V_{RMS}$ (Open voltage)

Specific case Netherlands:

NOT RELEVANT for freight wagons