



Organisation intergouvernementale pour les  
transports internationaux ferroviaires

Zwischenstaatliche Organisation für den  
internationalen Eisenbahnverkehr

Intergovernmental Organisation for  
International Carriage by Rail

# **Uniform Technical Prescription**

Applicable to the Rolling  
Stock subsystem:

**FREIGHT WAGONS**

**UTP WAG 2015**  
**Consolidated version**

Applicable from XX.XX.XXXX

 <b>OTIF</b>	<b>ROLLING STOCK</b> <b>FREIGHT WAGONS</b>		<b>UTP WAG 2015</b> Page 2 of 133	
	Status: <b>PROPOSAL</b>	Version: 04	TECH-16014-CTE9-5.1b	Original: EN

### Amendments Record

This is a consolidated version of the UTP applicable to the rolling stock subsystem: freight wagons. This version includes the CTE decisions as set out in the table below. The consolidated version is for information purposes only.

<u>Reference</u>	<u>History</u>	<u>Short explanation</u>
<u>UTP WAG A 94-02/2.2012</u> <u>version 7</u>	<u>Adopted 12.06.2013</u> <u>Notified 10.07.2013</u> <u>In force 1.1.2014</u>	<u>Transposition of EU Regulation 321/2013 as amended by Regulation 1236/2013 and also with:</u> <ul style="list-style-type: none"> <li>• <u>The provisions for the marking of freight wagons as set out in EU Commission Decision 2012/757/EU (OPE TSI) and EU Commission Decision 2007/756/EC on National Vehicle Registers as applicable from 1.1.2014.</u></li> <li>• <u>Some provisions related to safety management of Decision 2012/757/EC as indicated in App. I.</u></li> </ul> <u>Interfaces with CCS as indicated in App. H.</u>
<u>UTP WAG 2015</u>	<u>Adopted 4.6.2014</u> <u>Notified 18.7.2014</u> <u>In force 1.1.2015</u>	<u>Amendments:</u> <ul style="list-style-type: none"> <li>• <u>Deletion of Appendix P (now contained in UTP Marking) and modification of related references.</u></li> <li>• <u>Update of reference to list of approved composite brake blocks.</u></li> </ul> <u>Minor editorial change to Appendix I.</u>

 <b>OTIF</b>	<b>ROLLING STOCK</b> <b>FREIGHT WAGONS</b>		<b>UTP WAG 2015</b> <b>Page 3 of 133</b>	
	Status: <b>PROPOSAL</b>	Version: 04	TECH-16014-CTE9-5.1b	Original: EN

<u>Amendments according CTE 8 decision</u>	<u>Adopted 10.6.2015</u> <u>Notified 17.6.2015</u> <u>In force 1.12.2015</u>	<u>To take into account the update of:</u> <ul style="list-style-type: none"> <li>• <u>Appendix G: “List of fully approved composite brake blocks for international transport” and</u></li> <li>• <u>technical document: ERA/TD/2012-04/INT version 1.3 of 02.12.2014 “Attachment devices for rear-end signals, clearance for draw hooks, space for shunting staff operation, footsteps and handrails”</u></li> </ul> <u>As the equivalent EU documents are published by ERA on its website, there is no corresponding legal amendment on the EU side.</u>
<u>Amendments according CTE 9 decision</u>		<u>Main amendments:</u> <ul style="list-style-type: none"> <li>• <u>Amendments in order to allow the certification of “friction element for wheel tread brakes” (brake blocks)</u></li> <li>• <u>Clarifying the use the “GE” Marking in Appendix C</u></li> <li>• <u>Improving consistency between EU and OTIF provisions on axle traceability in point 4.2.3.6.4</u></li> <li>• <u>Amendments to reflect the new conformity assessment procedure CV</u></li> <li>• <u>Update of the reference to standards</u></li> </ul>

 <b>OTIF</b>	<b>ROLLING STOCK</b> <b>FREIGHT WAGONS</b>		<b>UTP WAG 2015</b> Page 4 of 133	
	Status: <b>PROPOSAL</b>	Version: 04	TECH-16014-CTE9-5.1b	Original: EN

## APTU Uniform Rules (Appendix F to COTIF 1999)

### **Uniform Technical Prescriptions (UTP) applicable to the Rolling Stock subsystem:**

#### **FREIGHT WAGONS - (UTP WAG)**

These regulations have been developed in accordance with the provisions of APTU, in particular Article 8, in the version as amended by the OTIF Revision Committee in 2009 and 2014, which entered into force on 1 ~~December~~ July 20105. For definitions and terms, see also Article 2 of the version of ATMF (Appendix G) and Article 2 of the version of APTU (Appendix F) in force since 1 July 2015, both Appendices to the 1999 version of the COTIF Convention ~~as applicable since 1 December 2010~~. Footnotes include both explanatory information (-which is not part of the regulations), and references to other regulations.

*Explanatory note:*

*The texts of this UTP which appear across two columns are identical to corresponding texts of the European Union regulations. Texts which appear in two columns differ; the left-hand column contains the UTP regulations, the right-hand column shows the text in the corresponding EU regulations. The text in the right-hand column is for information only and is not part of the OTIF regulations. Texts in the right-hand column which are not quoted from the WAG TSI, but from other EU regulations are in italics. Appendices H to ~~NO~~ do not appear in the WAG TSI.*

#### **0. EQUIVALENCE AND TRANSITIONAL PROVISIONS**

Following their adoption by the Committee of Technical Experts, the OTIF regulations included in this document are declared equivalent to the corresponding EU regulations within the meaning of Article 13 § 4 of APTU and Article 3a of ATMF, in particular with:

- The TSI for freight wagons Commission Regulation (EU) No 321/2013 of 13 March 2013, ~~which is applicable from 1.1.2014 as amended by Commission Regulations (EU) No 1236/2013 of 2 December 2013 and (EU) No 924/2015 of 8 June 2015~~, hereinafter referred to as the WAG TSI: ~~2013~~.

A UTP certificate of verification and a UTP declaration of verification of a vehicle<sup>1</sup> which is in conformity with the UTP WAG:

*(<sup>3</sup>)The declaration of verification and/or conformity to type of a new vehicle established in accordance with Decision*

<sup>1</sup> The validity of certificates and declarations referred to in this paragraph is indicated for the purpose of delivery of admission to operation according to ~~article~~ Article 6 of ATMF

 <b>OTIF</b>	<b>ROLLING STOCK FREIGHT WAGONS</b>		<b>UTP WAG 2015</b> Page 5 of 133	
	Status: <b>PROPOSAL</b>	Version: 04	TECH-16014-CTE9-5.1b	Original: EN

2012<sup>2</sup> shall be valid until the end of a transitional period of three years from 13 April 2013.

For Elements of Constructions which are assessed separately from the subsystem in accordance with section 5.1 of this UTP: after a transitional period of one year from 1 January 2014, all newly produced and separately assessed ICs, “rear-end signal”, shall be covered by the required declaration of conformity and/or suitability for use.

Notwithstanding the provisions in section 6.3, the following transitional provisions apply to Elements of Construction corresponding to a “friction element for wheel tread brakes” (further referred to in this paragraph as brake block) which are assessed separately from the subsystem:

brake blocks not certified in accordance with this UTP may be used on new, renewed or upgraded wagons if the brake block has already been used on a wagon which was admitted to international traffic in accordance with the UTPs, or authorised in at least one Member State of the EU, either before 1.7.2015, or before the expiry of the brake block’s approval period under the following conditions:

- If the brake block was manufactured before 1.7.2015, it may be used until 30.6.2025.
- If the brake block was manufactured from 1.7.2015 onwards and its approval period had not expired when it was produced, it may be used up to 10 years after the expiry of its approval period.

The production, upgrade or renewal of the wagon shall be completed, including its admission to international traffic, before these transitional periods expire.

*2006/861/EC shall be considered valid until the end of a transition period of three years after the entry into force of this Regulation.*

*(<sup>4</sup>) After a transition period of one year ~~after~~ following the entry into force of this Regulation, newly produced interoperability constituents ~~of~~ “rear-end signal”, shall be covered by the required EC declaration of conformity ~~and/or suitability for use~~.*

#### Article 8a(<sup>5</sup>)

1. Notwithstanding the provisions in Section 6.3 of the Annex, an EC certificate of verification may be issued for a subsystem containing components corresponding to the “friction element for wheel tread brakes” interoperability constituent that does not have an EC declaration of conformity during a transition period of 10 years after the date of application of this Regulation, if the following conditions are met:

- a) the component was manufactured before the date of application of this Regulation; and
- b) the interoperability constituent has been used in a subsystem that had been approved and placed in service in at least one Member State before the date of application of this Regulation.

2. The production, upgrade or renewal of any subsystem using non-certified interoperability constituents shall be completed, including granting authorisation for placing in service of the subsystem, before the transition period set out in paragraph 1 expires.

#### Article 8c

1. Notwithstanding the provisions in Section 6.3 of the Annex, an EC certificate of verification may be issued for a subsystem

<sup>3</sup> Article 9 of [Commission Regulation \(EU\) No 321/2013](#) enacting the WAG TSI

<sup>2</sup> A 94-02/3.2011

<sup>4</sup> Article 8(4) of [Commission Regulation \(EU\) No 1236/2013 amending](#) the WAG TSI

<sup>5</sup> [Articles 8a and 8c of Commission Regulation \(EU\) No 924/2015 amending the WAG TSI](#)

 <b>OTIF</b>	<b>ROLLING STOCK FREIGHT WAGONS</b>		<b>UTP WAG 2015</b> Page 6 of 133	
	Status: <b>PROPOSAL</b>	Version: 04	TECH-16014-CTE9-5.1b	Original: EN

Until the expiry of their current approval period, the brake blocks listed in Appendix G are deemed to comply with this UTP.

If a type or design of “friction element for wheel tread brakes” is assessed separately from the subsystem in accordance with this UTP, the corresponding type- or design examination certificate shall be valid for 10 years. During that period, new components of the same type or design may be used in a unit on the basis of a declaration of

containing components corresponding to the “friction element for wheel tread brakes” interoperability constituent that does not have an EC declaration of conformity during a transition period of 10 years after the expiry of the approval period of the interoperability constituent, if the following conditions are met:

a) the component was manufactured before the expiry of the approval period of the interoperability constituent; and

b) the interoperability constituent has been used in a subsystem that had been approved and placed in service in at least one Member State before the expiry of its approval period.

2. The production, upgrade or renewal of any subsystem using non-certified interoperability constituents shall be completed, including granting authorisation for placing in service of the subsystem, before the transition period set out in paragraph 1 expires.

#### Article 8b

1. Until the expiry of their current approval period, “friction element for wheel tread brakes” interoperability constituents listed in Appendix G of the Annex do not need to be covered by an EC declaration of conformity. During this period, “friction elements for wheel tread brakes” listed in Appendix G of the Annex shall be deemed to be compliant with this Regulation.

2. After their current approval period expires, “friction element for wheel tread brakes” interoperability constituents listed in Appendix G of the Annex shall be covered by EC declaration of conformity.

#### Article 9a

The EC-type or EC design examination certificate for the “friction element for wheel tread brakes” interoperability constituent shall be valid for 10 years. During that period, new constituents of the same type may be placed on the market on

 <b>OTIF</b>	<b>ROLLING STOCK FREIGHT WAGONS</b>			<b>UTP WAG 2015</b> Page 7 of 133
	Status: <b>PROPOSAL</b>	Version: 04	TECH-16014-CTE9-5.1b	Original: EN

conformity that refers to this type or design examination certificate.

This UTP contains open points relating to technical compatibility with the infrastructure, so the conditions for free circulation in accordance with ATMF Article 6 § 3 are not met. For this reason, ATMF Article 6 § 4 applies to wagons meeting the conditions prescribed in sections 4, 5 and 6 of this UTP, but not meeting the conditions of section 7.1.2.

However, if a vehicle also complies with the conditions prescribed in section 7.1.2 of this UTP, the open points are closed by means of particular technical solutions. Vehicles not subject to a specific case and meeting the conditions prescribed in section 7.1.2 meet the conditions of ATMF Article 3a § 2 and Article 6 § 3.<sup>6</sup>

the basis of an EC declaration of conformity that refers to this EC-type or EC design examination certificate.

(<sup>7</sup>)

<sup>6</sup> Such a vehicle may circulate freely in accordance with ATMF Article 6 § 3. Compatibility with the infrastructure is ensured by the rail transport undertaking under its responsibility in accordance with ATMF Article 6 § 2.

<sup>7</sup> The EU provisions are set out in 2008/57/EC Articles 21 to 25.

 <b>OTIF</b>	<b>ROLLING STOCK</b> <b>FREIGHT WAGONS</b>		<b>UTP WAG 2015</b> <b>Page 8 of 133</b>	
	Status: <b>PROPOSAL</b>	Version: 04	TECH-16014-CTE9-5.1b	Original: EN

## 1. INTRODUCTION

A Uniform Technical Prescription (UTP) is a set of rules relating to a subsystem or a part of it, as defined in APTU Appendix F to the Convention, in order:

- to ensure the interoperability of the rail system and
- to meet the essential requirements.

### 1.1. Technical scope

This UTP shall apply to freight wagons as defined in Section 2 of the present UTP which meet the criteria set out in the present section.

This UTP shall apply to freight wagons with a maximum operating speed lower than or equal to 160 km/h and a maximum axle load lower than or equal to 25 t.

This UTP shall apply to freight wagons which are intended to be operated on one or more of the following nominal track gauges: 1435 mm, 1524 mm, 1600 mm, and 1668 mm.

This UTP shall not apply to freight wagons operating mainly on the 1520 mm track gauge, which may occasionally be operated on 1524 mm track gauge.

This UTP shall apply to all new freight wagons intended for use in international traffic, taking into account section 7 of this UTP.

The present UTP shall also apply to existing freight wagon rolling stock

- (a) when it is renewed or upgraded in accordance with ATMF Article 10, or
- (b) with regard to specific provisions, such as the traceability of axles in point 4.2.3.6.4 and the maintenance plan in point 4.5.3.

A Technical Specification for Interoperability (TSI) is a specification that covers a subsystem (or part of it) as described in Article 2(i) of Directive 2008/57/EC in order:

<sup>(8)</sup> *The TSI shall apply to the 'rolling stock – freight wagons' subsystem as described in point 2.7 of Annex II to Directive 2008/57/EC.*

*The TSI shall apply to freight wagons with a maximum operating speed lower than or equal to 160 km/h and a maximum axle load lower than or equal to 25 t.*

*The TSI shall apply to freight wagons which are intended to be operated on one or more of the following nominal track gauges: 1435 mm, 1524 mm, 1600 mm, and 1668 mm. The TSI shall not apply to freight wagons operating mainly on the 1520 mm track gauge, which may occasionally be operated on 1524 mm track gauge.*

<sup>(9)</sup> *The TSI shall apply to all new freight wagon rolling stock of the European Union's rail system, taking into account Section 7 of the Annex.*

*The TSI set out in the Annex shall also apply to existing freight wagon rolling stock:*

- (a) *when it is renewed or upgraded in accordance with Article 20 of Directive 2008/57/EC, or*
- (b) *with regard to specific provisions, such as the traceability of axles in point 4.2.3.6.4 and the maintenance plan in point 4.5.3.*

<sup>8</sup> Article 2 of ~~the~~ Commission Regulation [\(EU\) No 321/2013](#) enacting the WAG TSI

<sup>9</sup> Article 3 of ~~the~~ Commission Regulation [\(EU\) No 321/2013](#) enacting the WAG TSI



 <b>OTIF</b>	<b>ROLLING STOCK</b> <b>FREIGHT WAGONS</b>		<b>UTP WAG 2015</b> Page 9 of 133	
	Status: <b>PROPOSAL</b>	Version: 04	TECH-16014-CTE9-5.1b	Original: EN

## 1.2. Geographical scope

The geographical scope of this

UTP comprises all lines open to, or used for international traffic, taking into account the limitations concerning the track gauge set out in Section 1.1

TSI is the network of the whole rail system, composed of:

- The trans-European conventional rail system network (TEN) as described in Annex I section 1.1 “Network” of Directive 2008/57/EC
- The trans-European high-speed rail system network (TEN) as described in Annex I section 2.1 “Network” of Directive 2008/57/EC
- Other parts of the network of the whole rail system, following the extension of scope as described in Annex I section 4 of Directive 2008/57/EC

and excludes the cases referred to in Article 1(3) of Directive 2008/57/EC.

## 1.3. Content of this document

In accordance with APTU – Appendix F to the Convention, this UTP:

In accordance with Article 5(3) of Directive 2008/57/EC, this TSI:

- indicates its intended scope (Chapter 2);
- lays down essential requirements for the part of the rolling stock subsystem concerned and for its interfaces vis-à-vis other subsystems (Chapter 3);
- establishes the functional and technical specifications to be met by the subsystem and its interfaces vis-à-vis other subsystems (Chapter 4).

- determines the

elements of construction

interoperability constituents

and interfaces which must be covered by European specifications, including European standards, which are necessary to achieve interoperability within the rail system (Chapter 5);

- states, in each case under consideration, which procedures are to be used in order to assess the conformity

with the provisions of the UTP (Chapter 6)

or the suitability for use of the interoperability constituents and the ‘EC’ verification of the subsystems (Chapter 6)

- indicates the strategy for implementing the

 <b>OTIF</b>	<b>ROLLING STOCK FREIGHT WAGONS</b>			<b>UTP WAG 2015</b> Page 10 of 133
	Status: <b>PROPOSAL</b>	Version: 04	TECH-16014-CTE9-5.1b	Original: EN

UTP (Chapter 7)

TSIs (Chapter 7)

(g) indicates, for the staff concerned, the professional qualifications and health and safety conditions at work that are required for the operation and maintenance of the above subsystem, as well as for the implementation of this

UTP (Chapter 4)

TSIs (Chapter 4)

## 2. SCOPE AND DEFINITION OF SUBSYSTEM

This UTP is applicable to wagons as defined in Article 2 (g) of APTU – Appendix F to the Convention, which are part of the subsystem Rolling Stock as defined in UTP GEN-B<sup>10</sup>, and which are intended to be used in international traffic.

This TSI is applicable to “freight wagons including vehicles designed to carry lorries” as referred to in Annex I section 1.2 of Directive 2008/57/EC taking into account the limitations as set out in Article 2.

This UTP is applicable to the subsystem “Operation and traffic management” with respect to the use of freight wagons within their limits and conditions of use and for the composition of trains with respect to freight wagons.

(<sup>11</sup>)

~~This~~ ~~The~~ UTP Marking is applicable to the assignment of the Unique Vehicle Number for the purpose of vehicle registration.

(<sup>12</sup>)

In the following this part of the subsystem rolling stock is called “freight wagon” and belongs to the subsystem “rolling stock”

as set out in the APTU Uniform Rules, UTP GEN-B. The other types of rolling stock listed in point 2.7 of UTP GEN-B are excluded from the scope of this UTP;

as set out in Annex II to Directive 2008/57/EC. The other vehicles listed in point 1.2 of Annex I to Directive 2008/57/EC are excluded from the scope of this TSI;

this is especially the case for mobile railway infrastructure construction and maintenance equipment and vehicles designed to carry

- motor vehicles with their passengers on board or
- motor vehicles without passengers on board but intended to be integrated in passenger trains (car carriers).

In the present

<sup>10</sup> A 94-01B/1.2012

<sup>11</sup> The EU requirements for the subsystem “Operation and traffic management” are set out in EU regulations, such as the OPE TSI.

<sup>12</sup> The European Vehicle Number is assigned according to the codes defined in Commission Decision 2007/756/EC, Appendix 6.

 <b>OTIF</b>	<b>ROLLING STOCK</b> <b>FREIGHT WAGONS</b>			<b>UTP WAG 2015</b> Page 11 of 133
	Status: <b>PROPOSAL</b>	Version: 04	TECH-16014-CTE9-5.1b	Original: EN

UTP

TSI

the following definitions are used:

(a) A **unit** is the generic term used to name the rolling stock. It is subject to the application of this

UTP and therefore subject to assessment in accordance with UTP GEN-D<sup>13</sup>.

TSI, and therefore subject to the EC verification procedure.

A unit can consist of:

- a **wagon** that can be operated separately, featuring an individual frame mounted on its own set of wheels or
- a rake of permanently connected **elements**, those elements cannot be operated separately or
- **separate rail bogies connected to compatible road vehicle(s)** the combination of which forms a rake of a rail compatible system.

(b) A **train** is an operational formation consisting of several units.

(c) The **design operating state** covers all conditions under which the unit is intended to operate and its technical boundaries.

This design operating state may go beyond the specifications of this UTP<sup>14</sup> in order that units may be used together in a train on the network according to the operating rules applicable to, or applied by the rail transport undertaking.

This design operating state may go beyond the specifications of this TSI in order that units may be used together in a train on the network under the safety management system of a railway undertaking.

Such operating rules include measures relating to train composition and measures designed to comply with the conditions and limits of use for the wagon and to ensure that the requirements as set out in section 4.4 are met during operation.

### 3. ESSENTIAL REQUIREMENTS

UTP GEN-A<sup>15</sup> sets out the essential requirements that must be met by the subsystems and elements of construction. Table 1 indicates the basic parameters

Article 4(1) of Directive 2008/57/EC states, that the rail system its subsystems and their interoperability constituents shall meet the relevant essential requirements. The essential

<sup>13</sup> A 94-01D/3.2011

<sup>14</sup> This means that a rail transport undertaking may require the vehicle to have properties which go beyond the UTP requirements if these properties are necessary for this rail transport undertaking to operate a vehicle. Such requirements may relate to compatibility with the other rolling stock operated by this rail transport undertaking or may relate to how its operational activities are organised.

<sup>15</sup> A 94-01A/1.2011

 <b>OTIF</b>	<b>ROLLING STOCK</b> <b>FREIGHT WAGONS</b>			<b>UTP WAG 2015</b> Page 12 of 133
	Status: <b>PROPOSAL</b>	Version: 04	TECH-16014-CTE9-5.1b	Original: EN

specified in the present UTP and their correlation to the essential requirements.

requirements are set out in general terms in Annex III of Directive 2008/57/EC. Table 1 indicates the basic parameters specified in this TSI and their correspondence to the essential requirements as explained in Annex III to Directive 2008/57/EC.

*Table 1*

Basic parameters and their correspondence to the essential requirements

point	basic parameter	essential requirements				
		safety	reliability & availability	health	environment protection	technical compatibility
4.2.2.1.1	End coupling	1.1.1, 1.1.3, 1.1.5, 2.4.1				
4.2.2.1.2	Inner coupling	1.1.1, 1.1.3, 2.4.1				
4.2.2.2	Strength of unit	1.1.1, 1.1.3, 2.4.1				
4.2.2.3	Integrity of the unit	1.1.1				
4.2.3.1	Gauging	1.1.1				2.4.3
4.2.3.2	Compatibility with load carrying capacity of lines	1.1.1				2.4.3
4.2.3.3	Compatibility with train detection systems	1.1.1				2.4.3
4.2.3.4	Axle bearing condition monitoring	1.1.1	1.2			2.4.3
4.2.3.5.1	Safety against derailment running on twisted track	1.1.1, 1.1.2, 2.4.1				2.4.3
4.2.3.5.2	Running dynamic behaviour	1.1.1, 1.1.2				2.4.3
4.2.3.6.1	Structural design of bogie frame	1.1.1, 1.1.2, 1.1.3				
4.2.3.6.2	Characteristics of wheelsets	1.1.1, 1.1.2, 1.1.3				2.4.3



Status: <b>PROPOSAL</b>	Version: 04	TECH-16014-CTE9-5.1b	Original: EN	Date: 1.4.2016
-------------------------	-------------	----------------------	--------------	----------------

4.2.3.6.3	Characteristics of wheels	1.1.1, 1.1.2, 1.1.3				2.4.3
4.2.3.6.4	Characteristics of axles	1.1.1, 1.1.2, 1.1.3				
4.2.3.6.5	Axle box / bearings	1.1.1, 1.1.2, 1.1.3				
4.2.3.6.6	Variable gauge wheelsets	1.1.1, 1.1.2, 1.1.3				
4.2.3.6.7	Running gear for manual change of wheelsets	1.1.1, 1.1.2, 1.1.3				
4.2.4.2	Brake - Safety requirements	1.1.1, 1.1.3	1.2 2.4.2			
4.2.4.3.1	Brake - General functional requirements	1.1.1 2.4.1	2.4.2			
4.2.4.3.2.1	Brake performance – In-service brake	1.1.1, 1.1.2 2.4.1	2.4.2			1.5
4.2.4.3.2.2	Brake performance – Parking brake	2.4.1				2.4.3
4.2.4.3.3	Brake - Thermal capacity	1.1.1, 1.1.3 2.4.1				2.4.3
4.2.4.3.4	Brake - Wheel slide protection (WSP)	2.4.1	2.4.2			
<a href="#">4.2.4.3.5</a>	<a href="#">Friction elements for wheel tread brakes</a>	<a href="#">1.1.1,</a> <a href="#">1.1.2,</a> <a href="#">1.1.3,</a> <a href="#">2.4.1</a>				<a href="#">2.4.3</a>
4.2.5	Environmental conditions	1.1.1 1.1.2				2.4.3
4.2.6.1	Fire safety	1.1.1 1.1.4				
4.2.6.1.2.1	Fire safety Barriers	1.1.4		1.3.2	1.4.2	
4.2.6.1.2.2	Fire safety Materials	1.1.4		1.3.2	1.4.2	
4.2.6.1.2.3	Fire safety Cables	1.1.4 1.1.5		1.3.2	1.4.2	
4.2.6.1.2.4	Fire safety – Flammable liquids	1.1.4		1.3.2	1.4.2	
4.2.6.2	Protection against electric hazard	1.1.5 2.4.1				

 <b>OTIF</b>	<b>ROLLING STOCK</b> <b>FREIGHT WAGONS</b>			<b>UTP WAG 2015</b> Page 14 of 133
	Status: <b>PROPOSAL</b>	Version: 04	TECH-16014-CTE9-5.1b	Original: EN

4.2.6.3	Attachment device for rear-end signal	1.1.1				
---------	---------------------------------------	-------	--	--	--	--

The essential requirements 1.3.1, 1.4.1, 1.4.3 and 1.4.5 of

UTP GEN-A<sup>16</sup> may fall under the scope of other legislation applicable in the Contracting State. The application of the present UTP does not ensure full compliance with these essential requirements.<sup>17</sup>

Annex III to Directive 2008/57/EC fall under the scope of other Union legislation.

#### 4. CHARACTERISATION OF THE SUBSYSTEM

##### 4.1. Introduction

In accordance with UTP GEN-B<sup>18</sup>, the rail system is divided into subsystems. Belonging to the subsystem rolling stock, freight wagons form a part of the rail system. The consistency of this system shall be verified.

The rail system, to which Directive 2008/57/EC applies and of which freight wagons form a part, is an integrated system whose consistency shall be verified.

This consistency shall be checked in particular with regard to the specifications of the rolling stock subsystem and the compatibility with the network (section 4.2), its interfaces in relation to the other subsystems of the rail system in which it is integrated (sections 4.2 and 4.3), as well as the initial operating and maintenance rules (section 4.4 and 4.5).

as requested by Article 18(3) of Directive 2008/57/EC.

The technical file, as set out in

UTP, General Provisions – GEN-C<sup>19</sup> and Article 10 § 6 of ATMF

Article 18(3) and Annex VI to Directive 2008/57/EC (section 4.8),

shall contain in particular design related values concerning the compatibility with the network.

<sup>16</sup> A 94-01A/1.2011

<sup>17</sup> Essential requirement 1.4.4 on noise pollution is deemed to be met for all vehicle-related parameters if the UTP Noise has been complied with.

<sup>18</sup> A 94-01B/1.2012

<sup>19</sup> A 94-01C/1.2011

 <b>OTIF</b>	<b>ROLLING STOCK</b> <b>FREIGHT WAGONS</b>			<b>UTP WAG 2015</b> Page 15 of 133
	Status: <b>PROPOSAL</b>	Version: 04	TECH-16014-CTE9-5.1b	Original: EN

## 4.2. Functional and technical specifications of the subsystem

### 4.2.1. General

In light of the essential requirements in Chapter 3, the functional and technical specifications of the subsystem “rolling stock - freight wagons” are grouped and sorted out in the following points of this Chapter:

- Structures and mechanical parts
- Gauging and vehicle track interaction
- Brake
- Environmental conditions
- System protection

Except where this is strictly necessary for the interoperability of the rail system and to meet the relevant essential requirements, the functional and technical specifications of the freight wagon and its interfaces do not impose the use of any particular technical solutions.

~~Innovative solutions, which do not fulfil the requirements specified in this~~

~~UTP~~

~~TSI~~

~~and/or which are not assessable as stated in this,~~

~~UTP~~

~~TSI~~

~~require new specifications and/or new assessment methods. In order to allow technological innovation, these specifications and assessment methods shall be developed by the process “innovative solution” described in~~

~~Points 6.1.3 and 6.2.3.~~

~~Chapter 6.~~

When the functional and technical specifications that are necessary in order to achieve interoperability and to meet the essential requirements, have not been developed concerning a particular technical aspect, this aspect is identified as an open point in the relevant point. As required in

Article 8 § 7 of APTU

Article 5(6) of Directive 2008/57/EC

all open points are listed in Appendix A.

In Appendix C a set of conditions is specified. The conformity with this set of conditions is optional. If this option is selected the conformity shall be assessed by

an Assessing Entity as defined in Article 5 § 2 of ATMF and UTP GEN-E<sup>20</sup>, using the procedure as defined in ATMF Article 4 and UTP GEN-D<sup>21</sup>.

a notified body within the EC verification procedure.

<sup>20</sup> A 94-01E/1.2011

<sup>21</sup> A 94-01D/3.2011

 <b>OTIF</b>	<b>ROLLING STOCK</b> <b>FREIGHT WAGONS</b>			<b>UTP WAG 2015</b> Page 16 of 133
	Status: <b>PROPOSAL</b>	Version: 04	TECH-16014-CTE9-5.1b	Original: EN

In accordance with

Article 8 § 6 of APTU,

Article 5(5) of Directive 2008/57/EC,

provision may be made for specific cases for each

UTP.

TSI.

Such provisions are indicated in Chapter 7.

As far as possible the assessment procedure for the requirements in section 4.2 is defined in Chapter 6. In these cases the text of section 4.2 makes a reference to the corresponding points and sub points clauses of Chapter 6. If for a particular basic parameter the separation of requirements and assessment procedures is not feasible, no reference is given.

#### 4.2.2. *Structures and mechanical parts*

##### 4.2.2.1. Mechanical Interface

###### 4.2.2.1.1. End coupling

The end coupling is the mechanical interface between units forming a train.

The coupling system shall be designed in a way that no human presence between the units to be coupled / uncoupled shall be required whilst either one unit is moving.

End couplings shall be resilient and capable of withstanding the forces in accordance with the defined design operating state of the unit.

###### 4.2.2.1.2. Inner coupling

The inner coupling is the mechanical interface between elements forming a unit.

The inner coupling shall be resilient and capable of withstanding the forces in accordance with the defined design operating state of the unit. The joint between two elements sharing the same running gear, is covered by point 4.2.2.2.

The longitudinal strength of the inner coupling(s) shall be equal to or higher than the one of the end coupling(s) of the unit.

###### 4.2.2.2. Strength of unit

The structure of a unit body, any equipment attachments and lifting and jacking points shall be designed such that no cracks, no significant permanent deformation or ruptures occur under the load cases defined in Chapter 5 of EN12663-2:2010. Joining techniques shall be deemed to be covered by the demonstration of conformity in accordance to point 6.2.2.1.

The demonstration of conformity is described in point 6.2.2.1.

The jacking positions shall be marked on the unit. The marking shall comply with point 4.5.13 of EN 15877-1:2012.

###### 4.2.2.3. Integrity of the unit

The unit shall be designed so that all movable parts intended to close an aperture (access doors, tarpaulin, lids, hatches, etc.) are prevented against an unintentional movement of these parts.

Locking devices shall indicate their status (open/closed) and shall be visible outside the unit.



 <b>OTIF</b>	<b>ROLLING STOCK</b> <b>FREIGHT WAGONS</b>			<b>UTP WAG 2015</b> Page 17 of 133
	Status: <b>PROPOSAL</b>	Version: 04	TECH-16014-CTE9-5.1b	Original: EN

#### 4.2.3. Gauging and track interaction

##### 4.2.3.1. Gauging

This point concerns the rules for calculation intended for sizing the rolling stock to run on one or several networks without interference risk.

The compliance of a unit with the intended reference profile including the reference profile for the lower part shall be established by one of the methods set out in EN 15273-2:2009.

The kinematic method, as described in EN 15273-2:2009 shall be used to establish conformity, if any, between the reference profile established for the unit and the respective target reference profiles G1, GA, GB and GC including those used for the lower part GIC1 and GIC2.

##### 4.2.3.2. Compatibility with load carrying capacity of lines

The vertical loading characteristics of the unit shall be determined in order to check compatibility with the load carrying capacity of lines.

The permissible payload a unit may carry, for axle loads up to and including 25t, shall be determined by application of clauses 6.1 and 6.2 of EN 15528:2008.

##### 4.2.3.3. Compatibility with train detection systems

If the unit is intended to be compatible with one or more of the following train detection systems, this compatibility shall be established

in accordance with the provisions of Appendix H of this UTP.

The parameters listed in (a), (b) and (c) shall be recorded in the technical file.<sup>22</sup>

according to the provisions of the Commission Decision 2012/88/EU.

###### (a) Train detection systems based on track circuits.

- The greatest distance between two consecutive axles
- The greatest distance between buffer end and first axle
- The minimum axle load in all load conditions
- The electrical resistance between the running surfaces of the opposite wheels of a wheelset.

(<sup>23</sup>)

###### (b) Train detection systems based on axle counters.

- The greatest distance between two consecutive axles
- The shortest distance between two

(<sup>25</sup>)

<sup>22</sup> The information included in the technical file is used by the rail transport undertaking to establish compatibility with the network on which it will operate the vehicle.

<sup>23</sup> EU provisions included in Commission Decision 2012/88/EU

<sup>25</sup> EU provisions included in Commission Decision 2012/88/EU

 <b>OTIF</b>	<b>ROLLING STOCK</b> <b>FREIGHT WAGONS</b>			UTP WAG 2015 Page 18 of 133
	Status: <b>PROPOSAL</b>	Version: 04	TECH-16014-CTE9-5.1b	Original: EN

- consecutive axles
- The distance between the end axles of the wagon
  - The distance between the end of the vehicle (e.g. buffer) and the first axle of the unit<sup>24</sup>
  - The wheel diameter
  - The metal-free space around wheels
  - The characteristics of the wheel material regarding magnetic fields
- (c) Train detection systems based on loop equipment.
- The metal-mass of the vehicle<sup>(26)</sup>

#### 4.2.3.4. Axle bearing condition monitoring

It shall be possible to monitor the axle bearing condition either by

- line side detection equipment or
- on-board equipment.

If the unit is intended to be capable of being monitored by line side equipment on the 1435 mm track gauge network the unit shall be compliant with clauses 5.1 and 5.2 of EN 15437-1:2009 in order to ensure sufficient visibility.

For units intended to be operated on the networks with track gauges of 1524 mm, 1600 mm, 1668 mm, the corresponding values in table 2 referring to the parameters of the standard EN 15437-1:2009 shall be applied.

*Table 2*

#### Target and prohibitive zone for units intended to be operated on particular networks

	$Y_{TA}$ [mm]	$W_{TA}$ [mm]	$L_{TA}$ [mm]	$Y_{PZ}$ [mm]	$W_{PZ}$ [mm]	$L_{PZ}$ [mm]
1524 mm (both areas are relevant)	1080±35	≥50	≥200	1080±5	≥140	≥500
	894±2	≥14	≥200	894±2	≥28	≥500
1600 mm	1110±2	>70	>180	1110±2	>125	>500
1668 mm	1176±10	≥55	≥100	1176±10	≥110	≥500

The specifications of the design and the conformity assessment of on-board equipment is an open point in this

<sup>24</sup> This value is used to define the distance between two consecutive axles of coupled wagons.

<sup>26</sup> EU provisions included in Commission Decision 2012/88/EU

 <b>OTIF</b>	<b>ROLLING STOCK</b> <b>FREIGHT WAGONS</b>			<b>UTP WAG 2015</b> Page 19 of 133
	Status: <b>PROPOSAL</b>	Version: 04	TECH-16014-CTE9-5.1b	Original: EN

UTP.

TSI.

#### 4.2.3.5. Running safety

The dynamic behaviour of a vehicle has a strong influence on safety against derailment, running safety and track loading.

##### 4.2.3.5.1. Safety against derailment running on twisted track

The unit shall be designed to ensure safe running on twisted track, taking into account specifically the transition phase between canted and level track and cross level deviations.

The demonstration of conformity is described in point 6.2.2.2.

##### 4.2.3.5.2. Running dynamic behaviour

The unit shall be designed to provide safe movement up to the maximum design speed.

The running dynamic behaviour of a unit shall be proven either by

- following the procedures set out in Chapter 5 of EN 14363:2005, or
- performing simulations using a validated model.

The demonstration of conformity is described in point 6.2.2.3.

Running dynamic behaviour is permitted to be assessed at

element of construction

interoperability constituent

level in accordance with point 6.1.2.1. In this case, a specific test or simulation at subsystem level is not required.

#### 4.2.3.6. Running gear

The running gear guarantees to carry and guide the unit safely as well as to transmit braking forces where so required.

##### 4.2.3.6.1. Structural design of bogie frame

The integrity of the structure of a bogie frame, all attached equipment and body to bogie connection shall be demonstrated based on methods as set out in point 6.2 of EN 13749:2011.

The integrity of the structure of a bogie frame is permitted to be assessed at

element of construction

interoperability constituent

level in accordance with point 6.1.2.1. In this case a specific test or simulation at subsystem level is not required.

##### 4.2.3.6.2. Characteristics of wheelsets

The wheelset assembly shall be able to transmit forces and torque between the fitted parts in accordance with the area of use.

The geometric dimensions of the wheelsets, as defined in figure 1, shall be compliant with limit values specified in table 3. These limit values shall be taken as design values and shall be stated as in-service limit values in the maintenance file described in section 4.5.

The demonstration of conformity is described in point 6.1.2.2.

 <b>OTIF</b>	<b>ROLLING STOCK</b> <b>FREIGHT WAGONS</b>		UTP WAG 2015 Page 20 of 133	
	Status: <b>PROPOSAL</b>	Version: 04	TECH-16014-CTE9-5.1b	Original: EN

*Fig. 1*  
**Symbols for wheelsets used in table 3**

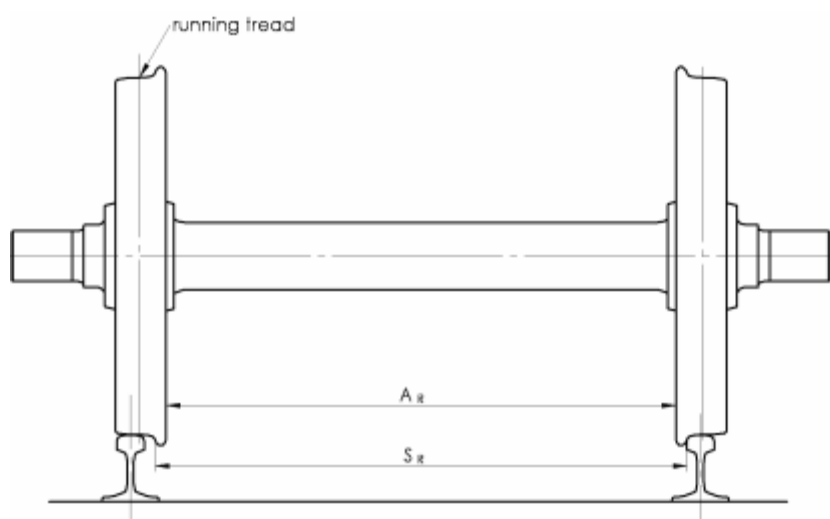

*Table 3*  
**Limits of use of the geometric dimensions of wheelsets**

Designation		Wheel diam. D [mm]	Minimum value [mm]	Maximum value [mm]
1435 mm	Front-to-front dimension ( $S_R$ ) $S_R = A_R + S_{d, \text{left}} + S_{d, \text{right}}$	$330 \leq D \leq 760$	1415	1426
		$760 < D \leq 840$	1412	1426
		$D > 840$	1410	1426
	Back to back distance ( $A_R$ )	$330 \leq D \leq 760$	1359	1363
		$760 < D \leq 840$	1358	1363
		$D > 840$	1357	1363
1524 mm	Front-to-front dimension ( $S_R$ ) $S_R = A_R + S_{d, \text{left}} + S_{d, \text{right}}$	$400 \leq D < 840$	1492	1514
		$D \geq 840$	1487	1514
	Back to back distance ( $A_R$ )	$400 \leq D < 840$	1444	1448

 <b>OTIF</b>	<b>ROLLING STOCK</b> <b>FREIGHT WAGONS</b>		<b>UTP WAG 2015</b> <b>Page 21 of 133</b>	
	Status: <b>PROPOSAL</b>	Version: 04	TECH-16014-CTE9-5.1b	Original: EN

		$D \geq 840$	1442	1448
1600 mm	Front-to-front dimension ( $S_R$ ) $S_R = A_R + S_{d, \text{left}} + S_{d, \text{right}}$	$690 \leq D \leq 1016$	1573	1592
1600 mm	Back to back distance ( $A_R$ )	$690 \leq D \leq 1016$	1521	1526
1668 mm	Front-to-front dimension ( $S_R$ ) $S_R = A_R + S_{d, \text{left}} + S_{d, \text{right}}$	$330 \leq D < 840$	1648 <sup>27</sup>	1659
		$840 \leq D \leq 1250$	1643 <sup>28</sup>	1659
	Back to back distance ( $A_R$ )	$330 \leq D < 840$	1592	1596
		$840 \leq D \leq 1250$	1590	1596

#### 4.2.3.6.3. Characteristics of wheels

The geometrical dimensions of the wheels as defined in Figure 2 shall be compliant with limit values specified in table 4.

*Table 4*  
**Limits of use of the geometric dimensions of wheels**

Designation		Wheel diam. D [mm]	Minimum value [mm]	Maximum value [mm]
1435 mm	Width of the rim ( $B_R$ ) (with maximum BURR of 5 mm)	$D \geq 330$	133	140
	Thickness of the flange ( $S_d$ )	$330 \leq D \leq 760$	27,5	33
		$760 < D \leq 840$	25	33
		$D > 840$	22	33
	Height of the flange ( $S_h$ )	$330 \leq D \leq 630$	31,5	36
		$630 < D \leq 760$	29,5	36
		$D > 760$	27,5	36
Face of the flange ( $q_R$ )	$D \geq 330$	6,5	-	
1524 mm	Width of the rim ( $B_R$ ) (with maximum BURR of 5 mm)	$D \geq 400$	134	140
	Thickness of the flange ( $S_d$ )	$400 \leq D < 760$	27,5	33
		$760 \leq D < 840$	25	33

<sup>27</sup> Two-axle wagons with axle load up to 22.5t the value shall be taken as 1651 mm

<sup>28</sup> Two-axle wagons with axle load up to 22.5t the value shall be taken as 1651 mm

 <b>OTIF</b>	<b>ROLLING STOCK</b> <b>FREIGHT WAGONS</b>		<b>UTP WAG 2015</b> <b>Page 22 of 133</b>	
	Status: <b>PROPOSAL</b>	Version: 04	TECH-16014-CTE9-5.1b	Original: EN

	Height of the flange ( $S_h$ )	$D \geq 840$	22	33
		$400 \leq D < 630$	31,5	36
		$630 \leq D < 760$	29,5	36
		$D \geq 760$	27,5	36
	Face of the flange ( $q_R$ )	$D \geq 400$	6,5	-
1600 mm	Width of the rim ( $B_R$ ) (with maximum BURR of 5 mm)	$690 \leq D \leq 1016$	137	139
	Thickness of the flange ( $S_d$ )	$690 \leq D \leq 1016$	26	33
	Height of the flange ( $S_h$ )	$690 \leq D \leq 1016$	28	38
	Face of the flange ( $q_R$ )	$690 \leq D \leq 1016$	6,5	-
1668 mm	Width of the rim ( $B_R$ ) (with maximum BURR of 5 mm)	$D \geq 330$	133	140
	Thickness of the flange ( $S_d$ )	$330 \leq D \leq 840$	27,5	33
		$D > 840$	22 (PT); 25 (ES)	33
	Height of the flange ( $S_h$ )	$330 \leq D \leq 630$	31,5	36
		$630 \leq D \leq 760$	29,5	36
		$D > 760$	27,5	36
Face of the flange ( $q_R$ )	$D \geq 330$	6,5	-	

These limit values shall be taken as design values and shall be stated as in-service limit values in the maintenance file described in section 4.5.

Fig. 2

**Symbols for wheels used in table 4**

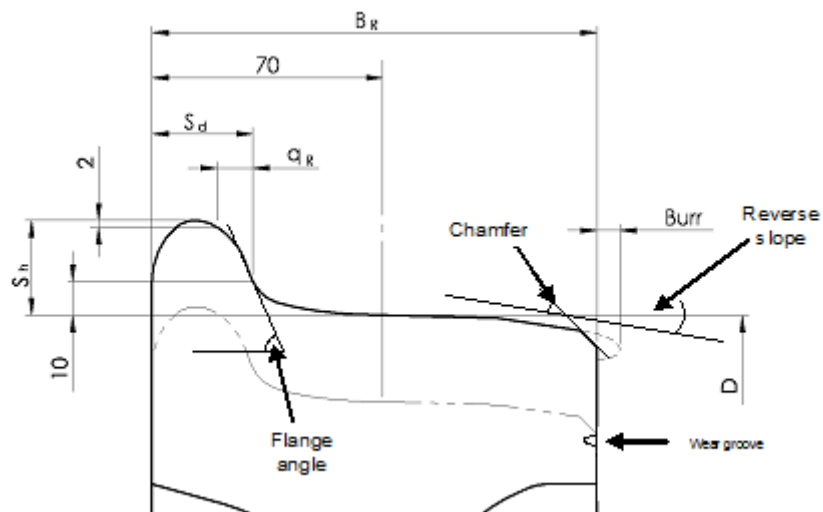

 <b>OTIF</b>	<b>ROLLING STOCK</b> <b>FREIGHT WAGONS</b>		<b>UTP WAG 2015</b> <b>Page 23 of 133</b>	
	Status: <b>PROPOSAL</b>	Version: 04	TECH-16014-CTE9-5.1b	Original: EN

The mechanical characteristics of the wheels shall ensure the transmission of forces and torque as well as the resistance against thermal load where so required in accordance with the area of use.

The demonstration of conformity is described in point 6.1.2.3.

#### 4.2.3.6.4. Characteristics of axles

The characteristics of the axle shall ensure the transmission of forces and torque in accordance with the area of use.

The demonstration of conformity is described in point 6.1.2.4.

The traceability of axles shall take into account the findings of the ERA Task Force on Freight Maintenance (see “Final report on the activities of the Task Force Freight Wagon Maintenance”

, version 1.0 of 5 October 2010,  
Axles shall be traceable.  
See also section 4.5.1 of the present UTP.

~~The traceability of axles shall take into accounts the findings of the ERA Task force on Freight Maintenance (see “Final report on the activities of the Task Force Freight Wagon Maintenance” published on the ERA website <http://www.era.europa.eu>).~~

published on the ERA website <http://www.era.europa.eu>).

#### 4.2.3.6.5. Axle boxes / bearings

The axle box and the rolling bearing shall be designed with consideration of mechanical resistance and fatigue characteristics. Temperature limits reached in service relevant for the hot box detection shall be defined.

The demonstration of conformity is described in point 6.2.2.4.

#### 4.2.3.6.6. Variable gauge wheelsets

This requirement is applicable to units equipped with variable gauge wheelsets with changeover between two track gauges.

The changeover mechanism of the wheelset shall ensure the safe locking

- of the wheels and
- of the corresponding brake equipment

in the correct intended axial position considering the dynamic effects in accordance with the design operating state of the unit.

The conformity assessment of the requirements specified in this point is an open point.

#### 4.2.3.6.7. Running gear for manual change of wheelsets

The requirement is applicable to units prepared to run on different track gauges, by means of a physical change of wheelset.

The unit shall be equipped with a locking mechanism in order to ensure the correct position of its brake equipment in the different configurations considering the dynamic effects in accordance with the design operating state of the unit.

The demonstration of conformity is described in point 6.2.2.5.

 <b>OTIF</b>	<b>ROLLING STOCK</b> <b>FREIGHT WAGONS</b>		<b>UTP WAG 2015</b> <b>Page 24 of 133</b>	
	Status: <b>PROPOSAL</b>	Version: 04	TECH-16014-CTE9-5.1b	Original: EN

#### 4.2.4. Brake

##### 4.2.4.1. General

The purpose of the train brake system is to ensure that

- the train's speed can be reduced,
- the train's speed can be maintained on a slope
- the train can be stopped within the maximum allowable braking distance and that
- the train can be immobilised.

Primary factors that influence the braking performance and the braking process are

- the braking power,
- the train mass,
- the speed,
- the allowable braking distance,
- the available adhesion and
- the track gradient.

The brake performance of a train is derived from the individual brake performance of each unit in the train.

##### 4.2.4.2. Safety requirements

The braking system contributes to the safety level of the railway system. Therefore the design of the braking system of a unit has to undergo a risk assessment in accordance with

UTP GEN-G Risk Evaluation and Assessment<sup>29</sup>,

Commission Regulation (EC) No 352/2009<sup>30</sup>

considering the hazard of complete loss of the brake capability of the unit. The severity level shall be deemed as catastrophic when

- it affects the unit alone (combination of failures) or,
- it affects the brake capability of more than the unit (single fault).

The fulfilment of the conditions of C.9 and C.14 of Appendix C is presumed to be in conformity with this requirement.<sup>31</sup>

##### 4.2.4.3. Functional and technical requirements

###### 4.2.4.3.1. General functional requirements

The brake equipment of the unit shall provide the functions of braking such as the application and the release of the brake, upon a transmitted signal. The brake shall be

- continuous (the brake application or release signal is transmitted from a central command to the whole train by a control line),

<sup>29</sup> A 94-01G/1.2012

<sup>30</sup> OJ L 108, 29.04.2009, p.4.

<sup>31</sup> For this reason no specific risk evaluation and assessment are required when the technical solutions of C.9 and C.14 of Appendix C are used.



 <b>OTIF</b>	<b>ROLLING STOCK</b> <b>FREIGHT WAGONS</b>		<b>UTP WAG 2015</b> <b>Page 25 of 133</b>	
	Status: <b>PROPOSAL</b>	Version: 04	TECH-16014-CTE9-5.1b	Original: EN

- automatic (an inadvertent disruption of the control line shall lead to brake activation on all units of the train bringing each part to stand still),
- disengageable, which enables its release and isolation.

#### 4.2.4.3.2. Brake performance

##### 4.2.4.3.2.1. Service brake

The brake performance of a train or a unit is its ability to decelerate. It is the result of the braking power available to decelerate the train or unit within defined limits and all factors involved in the conversion and dissipation of energy including train resistance.

The brake performance of a unit shall be calculated in accordance with one of the following documents:

- EN 14531-6:2009 or
- UIC leaflet 544-1:2013.

The calculation shall be validated by tests. Brake performance calculation in accordance with UIC 544-1 shall be validated as set out in UIC 544-1:2013.

##### 4.2.4.3.2.2. Parking brake

A Parking Brake is a brake used to prevent parked rolling stock moving under the specified conditions taking into account the place, wind, gradient and rolling stock loading state, until intentionally released.

If the unit is equipped with a parking brake, the following requirements shall be met:

- the immobilisation shall remain until intentionally released.
- where it is not possible to identify the state of the parking brake directly, an indicator showing the state shall be provided on both sides on the outside of the vehicle.
- the minimum parking brake performance, considering no wind, shall be determined by calculations as defined in clause 6 of EN 14531-6:2009.
- the minimum performance of the parking brake shall be marked on the unit. The marking shall comply with clause 4.5.25 of EN 15877-1:2012. The parking brake of a unit shall be designed considering a wheel/rail (steel/steel) adhesion factor not higher than 0,12.

##### 4.2.4.3.3. Thermal capacity

The brake equipment shall be able ~~of withstanding to withstand~~ one emergency brake application without any loss of brake performance due to thermal or mechanical effects.

The thermal load, the unit is capable to withstand without any adverse loss of brake performance due to thermal or mechanical effects, shall be defined and expressed in terms of speed, axle load, gradient and brake distance.

The demonstration of conformity is described in point 6.2.2.6.

A slope of 21 ‰ at 70 km/h during 40 km may be considered as the reference case for the thermal capacity which results in a braking power of 45 kW per wheel during 34 minutes for a nominal wheel diameter of 920 mm and an axle load of 22.5 t.

 <b>OTIF</b>	<b>ROLLING STOCK</b> <b>FREIGHT WAGONS</b>		<b>UTP WAG 2015</b> <b>Page 26 of 133</b>	
	Status: <b>PROPOSAL</b>	Version: 04	TECH-16014-CTE9-5.1b	Original: EN

#### 4.2.4.3.4. Wheel slide protection (WSP)

Wheel slide protection (WSP) is a system designed to use the maximum available adhesion by decreasing, holding or increasing the brake force to prevent wheel sets from locking and uncontrolled sliding. Thereby the stopping distance shall be optimized

If an electronic WSP-control is used negative effects caused by malfunctions of WSP shall be reduced by suitable system design processes and technical configuration.

The WSP shall not alter the functional characteristics of the brakes. The vehicle's air equipment shall be dimensioned such that the air consumption of the WSP does not impair the performance of the pneumatic brake. The design process of the WSP shall take into account that the WSP has no detrimental effect on the constituent parts of the vehicle (brake gear, wheel tread, axle boxes, etc.).

The following types of units shall be fitted with WSP:

- types of units equipped with all types of brake block except composite brake blocks, for which the maximum mean utilisation of adhesion is greater than 0,12.
- types of units equipped with disc brakes only and/or with composite brake blocks, for which the maximum mean utilisation of adhesion is greater than 0,11.

#### 4.2.4.3.5. Friction elements for wheel tread brakes

The friction element for wheel tread brakes (i.e. brake block) generates brake forces by friction when engaged with the wheel tread.

If wheel tread brakes are used the characteristics of the friction element shall contribute reliably to achieving the intended brake performance.

The demonstration of conformity is described in point 6.1.2.5 of this

UTP.

TSI.

#### 4.2.5. *Environmental conditions*

The design of the unit, as well as its constituents shall take into account the environmental conditions to which this rolling stock will be subjected to.

The environmental parameters are described in the clauses below. For each environmental parameter, a nominal range is defined, which is the most commonly encountered in Europe, and is the basis for the interoperable unit.

For certain environmental parameters ranges other than the nominal one are defined. In that case, a range shall be selected for the design of the unit.

For the functions identified in the clauses below, design and/or testing provisions taken to ensure that the rolling stock is meeting the

UTP

TSI

requirements in this range shall be described in the technical file.

Depending on the ranges selected and on provisions taken (described in the technical file), appropriate operating rules could be necessary when the unit designed for the nominal range is operated on a particular line where the nominal range is exceeded at certain periods of the year.

 <b>OTIF</b>	<b>ROLLING STOCK</b> <b>FREIGHT WAGONS</b>			<b>UTP WAG 2015</b> Page 27 of 133
	Status: <b>PROPOSAL</b>	Version: 04	TECH-16014-CTE9-5.1b	Original: EN

The ranges, if different from the nominal one, to be selected to avoid any restrictive operating rule(s) linked to environmental conditions, are specified by the

Contracting States

Member States

and are listed in section 7.4.

The unit and its constituents shall be designed under consideration of one or several of the following temperature classes allocated to external air temperature ranges

- T1: -25°C to +40°C (nominal),
- T2: -40°C to +35°C and
- T3: -25°C to +45°C

The unit shall meet the requirements of this

UTP

TSI

without degradation for snow, ice and hail conditions as defined in clause 4.7 of EN 50125-1:1999, which correspond to the nominal range.

Where more severe ‘snow, ice and hail’ conditions than considered in the standard are selected, the unit and its constituents shall then be designed to meet

UTP

TSI

requirements considering the combined effect with low temperature according to the temperature range chosen.

In relation with the temperature range T2 and with the severe conditions for snow, ice and hail, the provisions taken to meet

UTP

TSI

requirements in these severe conditions shall be identified and verified, in particular design and/or testing provisions considering the following functions:

- Coupling function restricted to the resiliency of couplings.
- Brake function, including brake equipment.

The demonstration of conformity is described in point 6.2.2.7.

#### 4.2.6. System protection

##### 4.2.6.1. Fire safety

###### 4.2.6.1.1. General

All significant potential fire sources (high risk components) on the unit shall be identified. The fire safety aspects of the unit design shall be aimed at

- preventing a fire from occurring,
- limiting the effects if a fire occurs.

The goods carried on the unit are not part of the unit and do not have to be taken into account in the conformity assessment.

 <b>OTIF</b>	<b>ROLLING STOCK</b> <b>FREIGHT WAGONS</b>			<b>UTP WAG 2015</b> <b>Page 28 of 133</b>
	<b>Status: PROPOSAL</b>	<b>Version: 04</b>	<b>TECH-16014-CTE9-5.1b</b>	<b>Original: EN</b>

#### 4.2.6.1.2. Functional and technical specification

##### 4.2.6.1.2.1. Barriers

In order to limit the effects of fire, fire barriers with integrity of at least 15 minutes shall be installed between the identified potential fire sources (high risk components) and the carried load.

The demonstration of conformity is described in point 6.2.2.8.1.

##### 4.2.6.1.2.2. Materials

All permanent materials used on the unit shall have limited ignitability and flame spread properties, unless

- the material is separated from all potential fire risks on the unit by a fire barrier and the safe application is supported by a risk assessment or
- the component has a mass <400g, and is located within a horizontal distance of  $\geq 40$  mm and a vertical distance of  $\geq 400$  mm to other non-tested components.

The demonstration of conformity is described in point 6.2.2.8.2.

##### 4.2.6.1.2.3. Cables

The selection and installation of electrical cables shall take into account their fire behaviour properties.

The demonstration of conformity is described in point 6.2.2.8.3.

##### 4.2.6.1.2.4. Flammable liquids

The unit shall be provided with measures preventing a fire from occurring and spreading due to leakage of flammable liquids or gases.

The demonstration of conformity is described in point 6.2.2.8.4.

#### 4.2.6.2. Protection against electrical hazards

##### 4.2.6.2.1. Protective measures against indirect contact (protective bonding)

The impedance between vehicle body and the running rail shall be low enough to prevent hazardous voltages between them.

Units shall be bonded in accordance with the provisions as described in clause 6.4 of EN 50153:2002.

##### 4.2.6.2.2. Protective measures against direct contact

The electrical installations and equipment of a unit shall be designed so as to protect persons from electric shock.

The unit shall be designed so that direct contact is prevented following the provisions set out in clause 5 of EN 50153:2002.

##### 4.2.6.3. Attachment devices for rear-end signal

On all units designed to receive a rear-end signal, two devices at the end of the unit shall provide for the installation of two lamps or two reflective plates as set out in Appendix E on the same height above rail not higher than 2000 mm.

The dimensions and clearance of these attachment devices shall be as described in

 <b>OTIF</b>	<b>ROLLING STOCK FREIGHT WAGONS</b>			<b>UTP WAG 2015</b> Page 29 of 133
	Status: <b>PROPOSAL</b>	Version: 04	TECH-16014-CTE9-5.1b	Original: EN

Appendix J.

chapter 1 of ERA technical document  
 ERA/TD/2012-04/INT version 1.2 of  
 18.01.2013 published on the ERA website  
 (<http://www.era.europa.eu>).

### 4.3. Functional and technical specification of the interfaces

The following sections contain tables 5, 6 and 7, with a three-column layout. The left and middle columns are part of this UTP.

The middle column also appears in the equivalent EU TSI, although the title of the middle column has been adapted<sup>32</sup> in order to fit both the EU and the OTIF document.

#### 4.3.1. Interface with the subsystem “infrastructure”

Table 5

#### Interface with infrastructure subsystem

Reference to the OTIF or national regulations	Reference in this UTP/ TSI	Reference Commission Decision 2011/275/EU
There are no infrastructure requirements in OTIF regulations. In accordance with ATMF Article 6 §2, it is the responsibility of the rail transport undertaking to ensure the compatibility of the vehicle with	4.2.3.1 Gauging	4.2.4.1 Minimum structure gauge
		4.2.4.2 Distance between track centres
		4.2.4.5 Minimum radius of vertical curve

<sup>32</sup> This middle column is not therefore exactly the same as the EU Regulation.

 <b>OTIF</b>	<b>ROLLING STOCK</b> <b>FREIGHT WAGONS</b>			<b>UTP WAG 2015</b> <b>Page 30 of 133</b>
	Status: <b>PROPOSAL</b>	Version: 04	TECH-16014-CTE9-5.1b	Original: EN

Reference to the OTIF or national regulations	Reference in this UTP/ TSI	Reference Commission Decision 2011/275/EU
the infrastructure it is operated on. The track design and layout are the responsibility of the Contracting State.	4.2.3.2      Compatibility with load carrying capacity of lines	4.2.7.1      Track resistance to vertical loads 4.2.7.3      Lateral track resistance 4.2.8.1      Resistance of bridges to traffic loads 4.2.8.2      Equivalent vertical loading for earthworks and earth pressure effects 4.2.8.4      Resistance of existing bridges and earthworks to traffic loads
	4.2.3.5.2      Running dynamic behaviour	4.2.9          Track geometrical quality
	4.2.3.6.2      Characteristics of wheelsets	4.2.5.1      Nominal track gauge 4.2.5.6      Rail head profile for plain line
	4.2.3.6.3      Characteristics of wheels	4.2.6.2      In service geometry of switches and crossings

 <b>OTIF</b>	<b>ROLLING STOCK</b> <b>FREIGHT WAGONS</b>			<b>UTP WAG 2015</b> <b>Page 31 of 133</b>
	<b>Status: PROPOSAL</b>	<b>Version: 04</b>	<b>TECH-16014-CTE9-5.1b</b>	<b>Original: EN</b>

4.3.2. *Interface with the subsystem “operation and traffic management”*

Table 6

**Interface with operation and traffic management subsystem**

<b>Reference to the OTIF or national regulations</b>	<b>Reference in this UTP/TSI</b>	<b>Reference Commission Decision 2011/314/EU</b>
COTIF does not define contingency arrangements; national contingency arrangements apply. The requirements in section 4.2.2.2 are deemed compatible with all national contingency measures.	4.2.2.2      Strength of unit - Lifting and jacking	4.2.3.6.3      Contingency arrangements
In accordance with ATMF Article 6 §2, it is the responsibility of the rail transport undertaking to ensure the compatibility of the vehicle with the infrastructure it is operated on.	4.2.3.1      Gauging	4.2.2.5      Train composition
	4.2.3.2      Compatibility with load carrying capacity of lines	4.2.2.5      Train composition
	4.2.4      Brake	4.2.2.6      Train braking
	4.2.6.3      Attachment devices for rear-end signal. Appendix E      Rear-end signal	4.2.2.1.3.2      Rear-end

 <b>OTIF</b>	<b>ROLLING STOCK</b> <b>FREIGHT WAGONS</b>		<b>UTP WAG 2015</b> <b>Page 32 of 133</b>	
	Status: <b>PROPOSAL</b>	Version: 04	TECH-16014-CTE9-5.1b	Original: EN

#### 4.3.3. Interface with the subsystem “control, command and signalling”

Table 7

#### Interface with control, command and signalling subsystem

Reference to the OTIF or national regulations	Reference in this UTP/TSI	Reference Commission Decision 2012/88/EU Annex A, table A2, index 77
The interfaces for compatibility with train detection systems are set out in Appendix H of this UTP.	4.2.3.3 a) Rolling stock characteristics compatible with train detection system based on track circuits	<ul style="list-style-type: none"> <li>– axle distances (3.1.2.1, 3.1.2.4, 3.1.2.5 and 3.1.2.6),</li> <li>– vehicle axle loads (3.1.7.1)</li> <li>– impedance between wheels (3.1.9),</li> <li>– use of composite brake blocks (3.1.6),</li> </ul>
	4.2.3.3 b) Rolling stock characteristics compatible with train detection system based on axle counters	<ul style="list-style-type: none"> <li>– axle distances (3.1.2.1, 3.1.2.2, 3.1.2.5 and 3.1.2.6),</li> <li>– wheel geometry (3.1.3.1 - 3.1.3.4),</li> <li>– metal / inductive components-free space between wheels (3.1.3.5)</li> <li>– wheel material (3.1.3.6).</li> </ul>
	4.2.3.3 c) Rolling stock characteristics compatible with train detection system based on loop equipment	<ul style="list-style-type: none"> <li>– vehicle metal construction ( 3.1.7.2).</li> </ul>

#### 4.4. Operating rules

The rail transport undertaking shall control the risks associated with the use of the wagon. Operating rules covering the activities and measures set out in Appendix I shall be established<sup>33</sup>.

Operating rules are developed within the procedures described in the railway undertaking safety management system.

These rules take into account the documentation related to operation which forms a part of the technical file as required in

<sup>33</sup> Unlike EU law, OTIF law does not specify who should establish these operating rules.



 <b>OTIF</b>	<b>ROLLING STOCK</b> <b>FREIGHT WAGONS</b>			<b>UTP WAG 2015</b> Page 33 of 133
	Status: <b>PROPOSAL</b>	Version: 04	TECH-16014-CTE9-5.1b	Original: EN

UTP GEN-C, General Provisions –  
Technical File <sup>34</sup>.

Article 18(3) of and as set out in Annex VI  
to Directive 2008/57/EC.

The documentation related to operation describes the characteristics of the unit in relation to the design operating state to be considered in order to define the operating rules in normal and in various reasonably foreseeable degraded modes.

The documentation related to operation is composed of:

- a description of operation in normal mode, including the operational characteristics and limitations of the unit (e.g. vehicle gauge, maximum design speed, axle loads, brake performance, compatibility with train detection systems, permitted environmental conditions).
- a description of operation in degraded mode (when equipment or functions described in this

UTP

TSI

suffer safety failures) as far as can reasonably predicted, together with the related acceptable limits and operating conditions of the unit that could be experienced.

The applicant shall provide the initial version of the documentation related to operating rules. This documentation might be modified later in accordance with the corresponding

rules

Union legislation,

taking into account the existing operating and maintenance conditions of the unit. The

Assessing Entity

Notified Body

shall verify only that the documentation on operation is provided.

#### 4.5. **Maintenance rules**

Maintenance is a set of activities intended to keep a functional unit in, or to restore it to a state in which it can perform its required function.

The following documents being part of the technical file as required in

UTP GEN-C<sup>35</sup>, General Provisions –  
Technical File

Article 18(3) of and as set out in Annex VI  
to Directive 2008/57/EC

are necessary to undertake maintenance activities on the units:

- General documentation (point 4.5.1)
- The maintenance design justification file (point 4.5.2) and
- The maintenance description file (point 4.5.3).

The applicant shall provide the three documents described in 4.5.1, 4.5.2. and 4.5.3 This documentation might be modified later in accordance with the corresponding

<sup>34</sup> A 94-01C/1.2011

<sup>35</sup> A 94-01C/1.2011

 <b>OTIF</b>	<b>ROLLING STOCK</b> <b>FREIGHT WAGONS</b>			<b>UTP WAG 2015</b> Page 34 of 133
	Status: <b>PROPOSAL</b>	Version: 04	TECH-16014-CTE9-5.1b	Original: EN

OTIF regulations, | EU legislation,  
taking into account the existing operating and maintenance conditions of the unit. The  
Assessing Entity | Notified Body  
shall verify only that the documentation on maintenance is provided.

#### 4.5.1. *General documentation*

The general documentation comprises of:

- Drawings and description of the unit and its components.
- Any legal requirement concerning the maintenance of the unit.
- Drawing of systems (electrical, pneumatic, hydraulic and control-circuit diagrams).
- Additional on-board systems (description of the systems including description of functionality, specification of interfaces and data processing and protocols).
- Configuration files for each vehicle (parts list and bill of material) to enable (in particular but not only) traceability during maintenance activities.

#### 4.5.2. *Maintenance design justification file*

The maintenance design justification file explains how maintenance activities are defined and designed in order to ensure that the rolling stock characteristics will be kept within permissible limits of use during its lifetime. The file shall give input data in order to determine the criteria for inspection and the periodicity of maintenance activities. The maintenance design justification file consists of

- Precedents, principles and methods used to design the maintenance of the unit.
- Limits of the normal use of the unit (e.g. km/month, climatic limits, foreseen types of loads etc.).
- Relevant data used to design the maintenance and origin of these data (return of experience).
- Tests, investigations and calculations carried out to design the maintenance.

#### 4.5.3. *Maintenance description file*

The maintenance description file describes how maintenance activities can be conducted. Maintenance activities include, among others, inspections, monitoring, tests, measurements, replacements, adjustments and repairs.

Maintenance activities are split into

- preventive maintenance (scheduled and controlled) and
- corrective maintenance.

The maintenance description file includes the following:

- Component hierarchy and functional description which sets up the boundaries of the rolling stock by listing all the items belonging to the product structure of that rolling stock and using an appropriate number of discrete levels. The lowest item of the hierarchy shall be a replaceable component.

 <b>OTIF</b>	<b>ROLLING STOCK</b> <b>FREIGHT WAGONS</b>		<b>UTP WAG 2015</b> <b>Page 35 of 133</b>	
	Status: <b>PROPOSAL</b>	Version: 04	TECH-16014-CTE9-5.1b	Original: EN

- Parts list which shall contain the technical and functional descriptions of the spare parts (replaceable units). The list shall include all parts specified for changing based on condition, which may require a replacement following electrical or mechanical malfunction or which will foreseeable require a replacement after an accidental damage.
- |                          |                               |
|--------------------------|-------------------------------|
| Elements of construction | Interoperability constituents |
|--------------------------|-------------------------------|
- shall be indicated and referenced to their corresponding declaration of conformity.
- Limit values for components which are not to be exceeded in service. It is permitted to specify operational restrictions in degraded mode (limit value reached).
  - List of reference to the
 

European	
----------	--

 legal obligations to which components or subsystems are subject.
 

<del>Maintenance plan<sup>36</sup></del>	<del>Maintenance plan<sup>37</sup></del>
------------------------------------------	------------------------------------------
  - Maintenance plan<sup>38</sup> i.e. the structured set of tasks to perform the maintenance including the activities, procedures and means. The description of this set of tasks includes:
    - (a) Disassembly/assembly instructions drawings necessary for correct assembly/disassembly of replaceable parts.
    - (b) Maintenance criteria.
    - (c) Checks and tests in particular of safety relevant parts; these include visual inspection and non-destructive tests (where appropriate e.g. to detect deficiencies that may impair safety).
    - (d) Tools and materials required to undertake the task.
    - (e) Consumables required to undertake the task.
    - (f) Personal protective safety provision and equipment.
  - Necessary tests and procedures to be undertaken after each maintenance operation before re-entry into service of rolling stock.

#### 4.6. Professional competencies

The professional competencies of staff required for

---

<sup>38</sup>The maintenance plan shall take into account the findings of the ERA Task Force on Freight Maintenance (see “Final report on the activities of the Task Force Freight Wagon Maintenance” published on the ERA website <http://www.era.europa.eu>)

 <b>OTIF</b>	<b>ROLLING STOCK</b> <b>FREIGHT WAGONS</b>			<b>UTP WAG 2015</b> <b>Page 36 of 133</b>
	<b>Status: PROPOSAL</b>	<b>Version: 04</b>	<b>TECH-16014-CTE9-5.1b</b>	<b>Original: EN</b>

(<sup>39</sup>)

#### 4.7. **Health and safety conditions**

The provisions for health and safety of staff required for the operation and maintenance of units are covered by the essential requirements 1.1.5, 1.3.1, 1.3.2, 2.5.1, 2.6.1 set out in

UTP General Provisions - Essential requirements (UTP GEN-A).

Annex III to Directive 2008/57/EC.

In particular, the following points of section 4.2 specify provisions for health and safety of staff:

Point 4.2.2.1.1: End coupling

Point 4.2.6.1: Fire safety

Point 4.2.6.2: Protection against electrical hazards. If the unit is fitted with a manual coupling system, a free space for shunters during coupling and uncoupling shall be provided.

All protruding parts deemed a hazard to operational staff shall be clearly indicated and/or fitted with protective devices.

The unit shall be equipped with footsteps and handrails except in those cases it is not intended to be operated with staff on-board, e.g. for shunting.

#### 4.8. **Parameters to be recorded in the technical file** <sup>40</sup>

The technical file shall contain at least the following parameters:

- Type, position and resiliency of the end coupling
- Load due to dynamic traction forces and compressive forces
- Gauge reference profiles to which the unit complies
- Conformity, if any, to target gauge reference profile(s) G1, GA, GB and GC
- Compliance, if any, to gauge lower reference profile(s) GIC1 and GIC2
- Mass per axle (tare and fully laden)
- Position of the axles along the unit and number of axles
- Length of the unit
- Maximum design speed Track gauges(s) the unit can be operated on
- Compatibility with train detection systems (track circuits / axle counters / loop equipment)

which shall include the data required in section 4.2.3.3 of this UTP

- Compatibility with hot axle box detection systems

<sup>39</sup> Professional competencies of staff required for the maintenance of units are not covered by this UTP, because they are covered by the regulation for the Entity in Charge of Maintenance.

<sup>40</sup> The full title of the section in the WAG TSI: ~~2013~~ in accordance with Commission Regulation (EU) No 1236/2013 -is "4.8 Parameters to be recorded in the technical file and European register of authorised types of vehicles".

 <b>OTIF</b>	<b>ROLLING STOCK</b> <b>FREIGHT WAGONS</b>			<b>UTP WAG 2015</b> Page 37 of 133
	Status: <b>PROPOSAL</b>	Version: 04	TECH-16014-CTE9-5.1b	Original: EN

- In-service temperature range of the axle bearings
- Nature of the signal which controls the brake (example: pneumatic main brake pipe, electric brake type XXX, ...)
- Characteristics of the control line and of its coupling with other units (main brake pipe diameter, section of the electric cable ...)
- Individual nominal performance of the brake unit, depending on the brake mode, if any (response time, brake force, level of adhesion required, ...)
- Braking distance or brake weight depending on the brake mode, if any.
- thermal load of the brake components expressed in terms of speed, axle load, gradient and brake distance
- Temperature range and severity level of snow/ice/hail conditions
- Brake weight and maximum gradient of the parking brake (if applicable)
- Ability / inability to be hump shunted
- Presence of footsteps and/or handrails

The rolling stock data that must be recorded in the “European register of authorized types of vehicles (ERATV)” are set out in the Commission Implementing Decision 2011/665/EU of 4 October 2011 on the European register of authorized types of railway vehicles.<sup>41</sup>

## 5. ELEMENTS OF CONSTRUCTION

## INTEROPERABILITY CONSTITUENTS

### 5.1. General

Elements of Construction (ICs), as defined in Article 2(g) of ATMF, Appendix G to the Convention,

Interoperability constituents (ICs), as defined in article 2(f) of Directive 2008/57/EC,

are listed in section 5.3 together with

- their area of use covering parameters of the subsystem and
- the reference to corresponding requirements defined in section 4.2.

An element of construction (IC) shall comply with the technical specifications of this chapter whether it is assessed separately as an IC or it is assessed as an integrated part of a subsystem.

Assessment of ICs separate from the subsystem is not mandatory in the COTIF regulations, but Contracting States or

<sup>41</sup> [OJ L 264, 8.10.2011, p.32.](#)

 <b>OTIF</b>	<b>ROLLING STOCK</b> <b>FREIGHT WAGONS</b>		<b>UTP WAG 2015</b> Page 38 of 133	
	Status: <b>PROPOSAL</b>	Version: 04	TECH-16014-CTE9-5.1b	Original: EN

regional organisations<sup>42</sup> may require mandatory separate assessment according to the specification in sections 5.3 and 6.1.2 of this UTP. This possibility is without prejudice to section 6.3.<sup>43</sup>

**Separate assessment of an IC:**

If the IC is in conformity with this UTP, as evidenced by the manufacturer in the form of a declaration of conformity or suitability for use according to section 6.1.2 of this UTP and chapter 2 of UTP GEN-D<sup>44</sup>, the IC shall be permitted to be used in accordance with its defined area of use, in accordance with section 5.3, in all Contracting States.

**Assessment of an IC integrated into a vehicle:**

If the IC is assessed as a part of the subsystem, the assessment procedures for subsystems apply. The requirements are identical to those if the IC were to be assessed separately, i.e. those set out in sections 5.3 and 6.1.2.

When a requirement is identified in section 5.3 as being assessed at IC level, an assessment for the same requirement at subsystem level is not required.

**5.2. Innovative solutions**

As stated in

~~Sections 6.1.3 -of the present UTP point 4.2.1,~~

~~section Article 10a4.1<sup>45</sup>,~~

innovative solutions may require new specifications and/or new assessment methods. Such specifications and assessment methods shall be developed using by the process described in point 6.1.3 whenever an innovative solution is envisaged for an IC.

**5.3. IC specifications**

**5.3.1. Running gear**

The running gear shall be designed for an application range, the area of use, as defined by the following parameters:

- Maximum speed

<sup>42</sup> In particular, compliance with EU law must be ensured when placing an IC on the market in the European Union.

<sup>43</sup> 6.3 permits, during a transitional period, the use of ICs produced before 1 January 2014.

<sup>44</sup> A 94-01D/3.2011

<sup>45</sup> [Article 10a of the Commission Regulation \(EU\) No 924/2015 amending the WAG TSI](#)

 <b>OTIF</b>	<b>ROLLING STOCK</b> <b>FREIGHT WAGONS</b>			<b>UTP WAG 2015</b> <b>Page 39 of 133</b>
	<b>Status: PROPOSAL</b>	<b>Version: 04</b>	<b>TECH-16014-CTE9-5.1b</b>	<b>Original: EN</b>

- Maximum cant deficiency
- Minimum tare of the unit
- Maximum axle load
- Range of distances between bogie pivots or range of wheelbase of “two-axle units”
- Maximum height of centre of gravity of empty unit
- Coefficient of height of centre of gravity of loaded unit minimum torsional stiffness coefficient of car body
- Maximum mass distribution coefficient for empty units with :

$$\frac{1}{2a^*} \cdot \sqrt{\frac{I_{zz}}{m}}$$

$I_{zz}$  moment of inertia of the car body relative to the vertical axis through the centre of gravity of the car body

$m$  mass of the car body

$2a^*$  wheelbase

- Minimum nominal wheel diameter
- Rail inclination

The parameters speed and axle load may be considered in combination in order to define the appropriate area of use (e.g. maximum speed and tare weight).

The running gear shall comply with the requirements expressed in points 4.2.3.5.2 and 4.2.3.6.1. These requirements shall be assessed at IC level.

### 5.3.2. *Wheelset*

The wheelset shall be assessed and designed for the area of use as defined by

- nominal wheel tread diameter and
- maximum vertical static force.

A wheelset shall comply with the requirements on geometrical and mechanical parameters defined in point 4.2.3.6.2. These requirements shall be assessed at IC level.

### 5.3.3. *Wheel*

A wheel shall be designed and assessed for an area of use defined by

- nominal tread diameter,
- maximum vertical static force,
- maximum speed and service life and
- maximum braking energy.

A wheel shall comply with the requirements on geometrical, mechanical and thermo mechanical parameters defined in point 4.2.3.6.3. These requirements shall be assessed at IC level.

### 5.3.4. *Axle*

An axle shall be designed and assessed for an area of use defined by

- maximum vertical static force.

 <b>OTIF</b>	<b>ROLLING STOCK</b> <b>FREIGHT WAGONS</b>			UTP WAG 2015 Page 40 of 133
	Status: <b>PROPOSAL</b>	Version: 04	TECH-16014-CTE9-5.1b	Original: EN

An axle shall comply with the requirements on mechanical parameters defined in point 4.2.3.6.4. These requirements shall be assessed at IC level.

**5.3.4a. Friction elements for wheel tread brakes**

Friction element for wheel tread brakes. The friction element for wheel tread brakes shall be designed and assessed for an area of use defined by:

- dynamic friction coefficients and their tolerance bands,
- minimum static friction coefficient,
- maximum permitted brake forces applied on the element,
- suitability for train detection by systems based on track circuits,
- suitability for severe environmental conditions.

A friction element for wheel tread brakes shall comply with the requirements defined in point 4.2.4.3.5. These requirements shall be assessed at IC level.

**5.3.5. Rear-end signal**

The rear-end signal, as described in Appendix E, is an independent IC. There are no requirements in section 4.2 dealing with the rear-end signal. Its assessment by the

Assessing Entity is not part of the conformity assessment	notified body is not part of the EC verification
-----------------------------------------------------------	--------------------------------------------------

of the subsystem.

**6. CONFORMITY ASSESSMENT AND VERIFICATION**

**6.1. Elements of Construction (IC) | Interoperability constituent (IC)**

**6.1.1. Modules**

The conformity assessment of an IC shall be performed in accordance with the module(s) described in table 8.

Table 8

<b>Assessment procedures for the verification of elements of construction</b>	<b>Modules for conformity assessment of interoperability constituents</b>
-------------------------------------------------------------------------------	---------------------------------------------------------------------------

Module CA1	Internal production control plus product verification by individual examination
Module CA2	Internal production control plus product verification at random intervals
Module CB	Type examination
Module CD	Conformity to type based on quality management system of the production process



 <b>OTIF</b>	<b>ROLLING STOCK FREIGHT WAGONS</b>			UTP WAG 2015 Page 41 of 133
	Status: <b>PROPOSAL</b>	Version: 04	TECH-16014-CTE9-5.1b	Original: EN

Module CF	Conformity to type based on product verification
Module CH	Conformity based on full quality management system
Module CH1	Conformity based on full quality management system plus design examination
<u>Module CV</u>	<u>Type validation by in-service experience (suitability for use)</u>

These modules are specified in detail in

UTP GEN-D General Provisions – Assessment Procedures (Modules)<sup>46</sup>.

the Commission Decision 2010/713/EU.

### 6.1.2. *Conformity Assessment procedures*

In accordance with UTP GEN-D, Contracting States may require the mandatory separate assessment of ICs. If not required by the Contracting State, separate assessment of ICs may be carried out on a voluntary basis.

The manufacturer or his authorised representative established within the Union shall

In case of conformity assessment of an IC as part of the subsystem, the compliance of the IC with the applicable provisions is verified by applying the modules for subsystem in accordance with section 6.2 of this UTP.

ICs for which module CV applies shall be assessed separately from the subsystem.

In the case of separate IC assessment, the manufacturer bears full responsibility for the UTP compliance of the product within its specified area of use.

In the case of separate IC assessment, the manufacturer shall

choose one of the modules or module combinations indicated in table 9 in accordance with the required

element of construction.

constituent.

*Table 9*

**Assessment procedures for the verification of elements of construction**

**Modules to be applied for interoperability constituents**

<sup>46</sup> A 94-01D/3.2011

 <b>OTIF</b>	<b>ROLLING STOCK</b> <b>FREIGHT WAGONS</b>			UTP WAG 2015 Page 42 of 133
	Status: <b>PROPOSAL</b>	Version: 04	TECH-16014-CTE9-5.1b	Original: EN

Point	Constituent	Modules					
		CA1 or CA2	CB+CD	CB+CF	CH	CH1	<u>CV</u>
4.2.3.6.1	Running gear		X	X		X	
	Running gear - established	X			X		
4.2.3.6.2	Wheelset	X <sup>(*)</sup>	X	X	X <sup>(*)</sup>	X	
4.2.3.6.3	Wheel	X <sup>(*)</sup>	X	X	X <sup>(*)</sup>	X	
4.2.3.6.4	Axle	X <sup>(*)</sup>	X	X	X <sup>(*)</sup>	X	
<u>4.2.4.3.5</u>	<u>Friction elements for wheel tread brakes</u>	<u>X<sup>(*)</sup></u>	<u>X</u>	<u>X</u>	<u>X<sup>(*)</sup></u>	<u>X</u>	<u>X<sup>(**)</sup></u>
5.3.5	Rear-end signal	X			X		

(\*) Modules CA1, CA2 or CH may be used only in the case of products placed on the market, and therefore developed, before

1 January 2014,

the entry into force of this TSI,

provided that the manufacturer demonstrates to the

Assessing Entity

NoBo

that design review and type examination were performed for previous applications under comparable conditions, and are in conformity with the requirements of this

UTP;

TSI;

this demonstration shall be documented, and is considered as providing the same level of proof as module CB or design examination according to module CH1.

(\*\*) Module CV shall be used in case the manufacturer of friction element for wheel tread brakes has no sufficient return of experience (according to its own judgment) for the proposed design.

Within the application of the chosen module or module combination the

element of construction

interoperability constituent

shall be assessed against the requirements mentioned in section 4.2. If necessary, additional requirements concerning the assessment of particular

element of construction

interoperability constituent

are given in the following clauses.

 <b>OTIF</b>	<b>ROLLING STOCK</b> <b>FREIGHT WAGONS</b>			<b>UTP WAG 2015</b> Page 43 of 133
	Status: <b>PROPOSAL</b>	Version: 04	TECH-16014-CTE9-5.1b	Original: EN

#### 6.1.2.1. Running gear

The demonstration of conformity for the running gear is set out in

Appendix B section 2.

in chapter 2 of ERA technical document  
ERA/TD/2013/01/INT version 1.0 of  
11.02.2013 published on the ERA website  
(<http://www.era.europa.eu>).

Units equipped with an established running gear as listed below are presumed to be in conformity with the relevant requirement provided that the running gears are operated within their established area of use:

- (a) Single axle running gear:
  - Double link suspension.
  - Niesky 2.
  - Suspension S 2000.
- (b) Two-axle bogie running gear:
  - Y25 family.
  - Two-axle steering axle bogie.
- (c) Three-axle bogies:
  - Three-axle bogie family with link suspension.

The assessment of the bogie frame strength shall be based on clause 6.2 of EN 13749:2011.

#### 6.1.2.2. Wheelset

The demonstration of conformity for the mechanical behaviour of the wheelset assembly shall be carried out according to clause 3.2.1 of EN13260:2009+A1:2010, which defines limit values for the axial assembly force and the associated verification test.

A verification procedure shall exist to ensure at the assembly phase that no defects may detrimentally affect safety due to any change in the mechanical characteristics of the fitted parts of the axle.

#### 6.1.2.3. Wheel

- (a) Forged and rolled wheels: The mechanical characteristics shall be proven following the procedure as specified in clause 7 of EN 13979-1:2003+A1:2009+A2:2011.  
If the wheel is intended to be used with brake blocks acting on the wheel running surface, the wheel shall be thermo mechanically proven by taking into account the maximum braking energy foreseen. A type test, as described in clause 6.2 of EN 13979-1:2003+A1:2009+A2:2011 shall be performed in order to check that the lateral displacement of the rim during braking and the residual stress are within the specified tolerance limits.  
The decision criteria of residual stresses for forged and rolled wheels are set out in EN 13979-1:2003+A1:2009+A2:2011.
- (b) Other types of wheels: Other types of wheels are permitted for units in national use. In that case the decision criteria and the fatigue stress criteria shall be specified in national rules.

 <b>OTIF</b>	<b>ROLLING STOCK</b> <b>FREIGHT WAGONS</b>		<b>UTP WAG 2015</b> <b>Page 44 of 133</b>	
	Status: <b>PROPOSAL</b>	Version: 04	TECH-16014-CTE9-5.1b	Original: EN

Such national rules may only be applied to international traffic when they are in force in accordance with Article 12 of APTU, Appendix F to the Convention.

Those national rules shall be notified by Member States in accordance with Article 17(3) of Directive 2008/57/EC.

A verification procedure shall exist to ensure at the production phase that no defects may detrimentally affect safety due to any change in the mechanical characteristics of the wheels. The tensile strength of the material in the wheel, the hardness in the rim, the fracture toughness (only for tread-braked wheels), resistance to impact, the material characteristics and the material cleanliness shall be verified. The verification procedure shall specify the batch sampling used for each characteristic to be verified.

#### 6.1.2.4. Axle

In addition to the requirement on the assembly above, the demonstration of conformity of mechanical resistance and fatigue characteristics of the axle shall be based on clauses 4, 5 and 6 of EN13103:2009+A2:2012.

The decision criteria for the permissible stress are specified in clause 7 of EN 13103:2009+A2:2012. A verification procedure shall exist to ensure at the production phase that no defects may detrimentally affect safety due to any change in the mechanical characteristics of the axles. The tensile strength of the material in the axle, the resistance to impact, the surface integrity, the material characteristics and the material cleanliness shall be verified. The verification procedure shall specify the batch sampling used for each characteristic to be verified.

#### 6.1.2.5. Friction elements for wheel tread brakes

The demonstration of conformity of friction elements for wheel tread brakes shall be carried out by determining the following friction element properties in accordance with the:

Appendix O:

the European Railway Agency (ERA) technical document ERA/TD/2013-02/INT version 2.0 of XX.XX.2014 published on the ERA website (<http://www.era.europa.eu>):

- dynamic friction performance (chapter 4);
- static friction coefficient (chapter 5);
- mechanical characteristics including properties in respect to shear strength test and flexural strength test (chapter 6).

Demonstration of the following suitabilities shall be carried out in accordance with chapters 7 and/or 8 of

-Appendix O,

the ERA technical document ERA/TD/2013-02/INT version 2.0 of XX.XX.2014 published on the ERA website (<http://www.era.europa.eu>),

if the friction element is intended to be suitable for:

 <b>OTIF</b>	<b>ROLLING STOCK</b> <b>FREIGHT WAGONS</b>		<b>UTP WAG 2015</b> <b>Page 45 of 133</b>	
	Status: <b>PROPOSAL</b>	Version: 04	TECH-16014-CTE9-5.1b	Original: EN

- train detection by systems based on track circuits; and/or
- severe environmental conditions.

If a manufacturer does not have sufficient return of experience (according with its own judgement) for the proposed design, the type validation by in-service experience procedure (module CV) shall be part of the assessment procedure for suitability for use. Before commencing in-service tests, a suitable module (CB or CH1) shall be used to certify the design of the interoperability constituent.

The in-service tests shall be organised on request from the manufacturer, who must obtain agreement from a railway undertaking that will contribute to such an assessment.

The suitability for train detection by systems based on track circuits for friction elements intended to be used in subsystems beyond the scope set out in chapters 7 of

Appendix O,

the ERA technical document ERA/TD/2013-02/INT version 2.0 of XX.XX.2014 published on the ERA website (<http://www.era.europa.eu>),

may be demonstrated using the procedure for innovative solutions described in point 6.1.3.

The suitability for severe environmental conditions by a dynamometer test for friction elements intended to be used in subsystems beyond the scope set out in clause 8.2.1 of

Appendix O,

the ERA technical document ERA/TD/2013-02/INT version 2.0 of XX.XX.2014 published on the ERA website (<http://www.era.europa.eu>),

may be demonstrated using the procedure for innovative solutions described in point 6.1.3.

### 6.1.3. *Innovative solutions ~~for ICs~~*

~~If an innovative solution (as defined in point 4.2.1) is proposed for an~~

~~is proposed for an element of construction,~~

referred to in Article 10a is proposed for an interoperability constituent,

~~the manufacturer or his authorised representative~~

established within the Union

~~shall apply~~

~~as defined in section 5.2,~~

~~the innovative solution may only be used in vehicles in international traffic after agreement from the Committee of Technical Experts (CTE). A manufacturer may state the deviations from the relevant point of this UTP and submit them via the competent authority of an OTIF Contracting State to the~~

the manufacturer or his authorised representative established within the Union shall the procedure set out in Article 10a state the deviations from the relevant point of this TSI and submit them to the European Commission for analysis.

 <b>OTIF</b>	<b>ROLLING STOCK FREIGHT WAGONS</b>			<b>UTP WAG 2015</b> Page 46 of 133
	Status: <b>PROPOSAL</b>	Version: 04	TECH-16014-CTE9-5.1b	Original: EN

~~OTIF Secretariat, which will submit them to the CTE for analysis mutatis mutandis the procedure set out in clause 6.2.3 of this UTP.~~

~~In case the analysis results in a favourable opinion, the appropriate functional and interface specifications as well as the assessment method which are necessary to be included in the~~

~~UTP~~

~~TSI~~

~~in order to allow the use of this constituent will be developed.~~

~~The appropriate functional and interface specifications and the assessment methods so produced shall be incorporated in the~~

~~UTP~~

~~TSI~~

~~by the revision process.~~

~~By the notification of a decision of the~~

~~Committee of Technical Experts,~~

~~Commission, taken in accordance with Article 29 of Directive 2008/57/EC,~~

~~the innovative solution may be permitted to be used.~~

## 6.2. Subsystem

### 6.2.1. Modules

For requirements applicable to the functional subsystems<sup>47</sup>, conformity with the requirement shall be ensured during operation. Assessment of the functional parts is not included in the tasks of the Assessing Entity. The

The EC

verification of the subsystem “Rolling stock – freight wagons” shall be performed in accordance with the module(s) described in table 10.

Table 10

<sup>47</sup> This UTP contains requirements applicable to two functional subsystems in accordance with UTP GEN-B; the first being Operation and traffic management, the second being maintenance. The requirements related to the function subsystem concern (part of the) sections 4.2.3.6.4, 4.3.2, 4.4, 4.5.1, 4.6 and **Appendix PPUTP Marking**, which apply to the use of freight wagons.

 <b>OTIF</b>	<b>ROLLING STOCK</b> <b>FREIGHT WAGONS</b>		<b>UTP WAG 2015</b> <b>Page 47 of 133</b>	
	Status: <b>PROPOSAL</b>	Version: 04	TECH-16014-CTE9-5.1b	Original: EN

**Assessment procedures for the verification of subsystems**

**Modules for EC verification of subsystems**

(OTIF) Type examination	SB	EC-Type Examination
Quality management system of the production process	SD	EC verification based on quality management system of the production process
Verification based of product verification	SF	EC verification based on product verification
Verification based on full quality management system plus design examination	SH1	EC verification based on full quality management system plus design examination

These modules are specified in detail in

APTU Uniform Rules, Appendix F to COTIF 1999 - UTP GEN-D

the Decision 2010/713/EU.

**6.2.2. Verification procedures**

*EC verification procedures*

The applicant shall choose one of the following combinations of modules or module for the

EC

verification of the subsystem.

- (SB+SD) or
- (SB+SF) or
- (SH1).

Within the application of the chosen module or module combination the subsystem shall be assessed against the requirements mentioned in section 4.2. If necessary, additional requirements concerning the assessment of particular constituents are given in the following clauses.

**6.2.2.1. Strength of unit**

The demonstration of conformity shall be in accordance with chapters 6 and 7 of EN 12663-2:2010.

Regarding joints, a recognised verification procedure shall exist to ensure at the production phase that no defect may decrease the intended mechanical characteristics of the structure.

**6.2.2.2. Safety against derailment running on twisted track**

The demonstration of conformity shall be carried out either in accordance with

 <b>OTIF</b>	<b>ROLLING STOCK</b> <b>FREIGHT WAGONS</b>		<b>UTP WAG 2015</b> <b>Page 48 of 133</b>	
	Status: <b>PROPOSAL</b>	Version: 04	TECH-16014-CTE9-5.1b	Original: EN

- the procedure defined in section 4.1 of EN 14363:2005 or
- the method given in section 4.2 of EN15839:2012 by using the pre-calculation for standardised solutions.

#### 6.2.2.3. Running dynamic behaviour

##### *On-track tests*

The demonstration of conformity shall be carried out in accordance with Chapter 5 of EN 14363:2005.

As an alternative to perform on-track tests on two different rail inclinations, as set out in clause 5.4.4.4 in EN 14363:2005, ~~it is permitted to perform~~ tests may be carried out on only one rail inclination if it is demonstrated that the tests cover the range of contact conditions as set out defined in Appendix B, section 1.1. of

Appendix B.

ERA technical document  
ERA/TD/2013/01/INT version 1.0 of  
11.02.2013 published on the ERA website  
(<http://www.era.europa.eu>).

When an on-track test with normal measuring method is required the unit shall be assessed against the limit values set out in

Appendix B, sections 1.2 and ~~B~~-1.3.

sections 1.2 and 1.3 of ERA technical document ERA/TD/2013/01/INT version 1.0 of 11.02.2013 published on the ERA website (<http://www.era.europa.eu>).

The combination of the highest equivalent conicity and speed for which the unit meets the stability criterion in clause 5 of EN 14363:2005 shall be recorded in the report.

The required test conditions for on-track tests, as set out in EN 14363:2005, are not always fully achievable concerning

- track geometric quality and
- combinations of speed, curvature, cant deficiency.

In cases this is not fully achievable the demonstration of conformity is an open point.

##### *Simulations*

Alternatively, under the conditions stated in section 9.3 of EN 15827:2011, a simulation may replace the above mentioned on-track tests.

#### 6.2.2.4. Axle box / bearings

The demonstration of conformity for mechanical resistance and fatigue characteristics of the rolling bearing shall be in accordance with clause 6 of EN12082:2007+A1:2010.

#### 6.2.2.5. Running gear for manual change of wheelsets

##### *Changeover between 1435 mm and 1668 mm track gauges*

The technical solutions described in the following figures of the UIC leaflet 430-1:2012 are deemed to be compliant with the requirements in point 4.2.3.6.7 :



 <b>OTIF</b>	<b>ROLLING STOCK</b> <b>FREIGHT WAGONS</b>			<b>UTP WAG 2015</b> Page 49 of 133
	Status: <b>PROPOSAL</b>	Version: 04	TECH-16014-CTE9-5.1b	Original: EN

- for axle units: figures 9 and 10 of Annex B.4, and figure 18 of Annex H of UIC leaflet 430-1:2012,
- for bogie units: figure 18 of Annex H of UIC leaflet 430-1:2012.

*Changeover between 1435 mm and 1524 mm track gauges*

The technical solution described in Appendix 7 of UIC leaflet 430-3:1995 is deemed to be compliant with the requirements in point 4.2.3.6.7.

#### 6.2.2.6. Thermal capacity

Calculations, simulations or tests shall demonstrate that the temperature of the brake block, brake pad or brake disc does not exceed their thermal capacity. The following shall be taken into account:

- (a) Concerning the emergency brake application: the critical combination of speed and payload considering straight and level track, minimum wind and dry rails
- (b) Concerning the continuous brake application:
  - the range up to the maximum braking power,
  - the range up to the maximum speed and
  - the corresponding brake application time.

#### 6.2.2.7. Environmental conditions

Steel materials are deemed to comply with all the ranges indicated in point 4.2.5 if the material properties are determined down to -20°C.

#### 6.2.2.8. Fire safety

##### 6.2.2.8.1. Barriers

Barriers shall be tested in accordance with EN1363-1:1999. Steel sheets of at least 2 mm thickness and aluminium sheets of at least 5 mm thickness are deemed to comply with the integrity requirements without testing.

##### 6.2.2.8.2. Materials

Testing of the materials ignitability and flame spread properties shall be performed in accordance with ISO 5658-2:2006/Am1:2011 for which the limit value shall be CFE  $\geq$  18 kW/m<sup>2</sup>.

For the following materials and components the fire safety requirements are deemed to comply with the required ignitability and flame spread properties:

- Metals and alloys with inorganic coatings (such as, but not limited to: galvanized coating, anodic coating, chromate film, phosphate conversion coating).
- Metals and alloys with an organic coating with a nominal thickness less than 0.3 mm (such as, but not limited to paints, plastic coating, asphaltic coating).
- Metals and alloys with a combined inorganic and organic coating of which the nominal thickness of the organic layer is less than 0.3 mm.
- Glass, stoneware, ceramic and natural stone products.
- Materials that meet the requirements of category C-s3, d2 or higher in accordance with EN 13501-1:2007+A1:2009.

 <b>OTIF</b>	<b>ROLLING STOCK FREIGHT WAGONS</b>		<b>UTP WAG 2015 Page 50 of 133</b>	
	Status: <b>PROPOSAL</b>	Version: 04	TECH-16014-CTE9-5.1b	Original: EN

### 6.2.2.8.3 Cables

The electrical cables shall be selected and installed in accordance with EN 50355:2003 and EN 50343:2003.

### 6.2.2.8.4 Flammable liquids

The measures taken shall be in accordance with TS 45545-7:2009.

### 6.2.3. *Innovative solutions*

If an innovative solution

referred to in Article 10a

is proposed for the subsystem “Rolling stock – freight wagons” subsystem includes an innovative solution (as defined in section 4.2.1), the applicant shall apply the procedure set out in

below:

in Article 10a<sup>48</sup>

In order to keep pace with technological progress, innovative solutions may be required that do not comply with the specifications set out in this UTP or for which the assessment methods set out in this UTP cannot be applied. In that case, new specifications and/or new assessment methods associated with those innovative solutions shall be developed.

2. Innovative solutions may be related to the “rolling stock — freight wagons” subsystem, its parts and its elements of construction.

3. If an innovative solution is proposed, the manufacturer or his authorised representative shall declare how it deviates from or complements the relevant provisions of this UTP and shall submit the deviations to the Secretary General for analysis.

The Secretary General will coordinate its opinion with the EU and the European Railway Agency on the proposed innovative solution and submit its opinion to the Committee of Technical Experts (CTE).

4. If the CTE supports the opinion, the appropriate functional and interface specifications and the assessment method, which must be included in the UTP in order to allow the use of this innovative solution,

<sup>48</sup> Article 10a of the Commission Regulation (EU) No 924/2015 amending the WAG TSI

 <b>OTIF</b>	<b>ROLLING STOCK FREIGHT WAGONS</b>			<b>UTP WAG 2015</b> Page 51 of 133
Status: <b>PROPOSAL</b>	Version: 04	TECH-16014-CTE9-5.1b	Original: EN	Date: 1.4.2016

shall be developed in coordination with the EU and subsequently integrated in the UTP during the revision process

5. Pending the revision of the UTP, the positive CTE opinion shall be considered as acceptable means of compliance with the essential requirements of UTP GEN-A and may therefore be used for the assessment of the subsystem.

~~state the deviations from the relevant clauses of the~~

~~UTP, after which a Contracting State may (on behalf of the applicant) submit them to the OTIF Secretariat, which will submit them to the Committee of Technical Experts for analysis.~~

~~TSI, and submit them to the Commission for analysis.~~

~~In case the analysis results in a favourable opinion, the appropriate functional and interface specifications as well as the assessment methods which are necessary to be included in the~~

~~UTP~~

~~TSI~~

~~in order to allow this solution will be developed.~~

~~The appropriate functional and interface specifications and the assessment methods so produced shall then be incorporated in the~~

~~UTP~~

~~TSI~~

~~by the revision process.~~

~~By the notification of a decision of the~~

~~Committee of Technical Experts,~~

~~Commission, taken in accordance with Article 29 of Directive 2008/57/EC,~~

~~the innovative solution may be permitted to be used.~~

6.3. **Subsystem containing components corresponding to an IC not holding a declaration**

**Subsystem containing components corresponding to an interoperability constituents not holding an EC declaration**

An Assessing Entity

A Notified Body

is permitted to issue

a UTP Certificate of verification

an EC certificate of verification

of a subsystem, even if one or more of the components corresponding to

 <b>OTIF</b>	<b>ROLLING STOCK FREIGHT WAGONS</b>			<b>UTP WAG 2015</b> Page 52 of 133
	Status: <b>PROPOSAL</b>	Version: 04	TECH-16014-CTE9-5.1b	Original: EN

elements of construction

interoperability constituents

incorporated within the subsystem are not covered by a relevant

declaration of conformity for ICs in accordance with this UTP<sup>49</sup>. Such non-certified ICs are permitted to be used if the element of construction

EC declaration of conformity in accordance with this TSI (non certified ICs) if the constituent

was manufactured before

1 January 2014

the entry into force of this TSI

and the type of constituent has been

- used in a subsystem already approved, and
- ~~placed put~~ in service in at least one

Contracting State before 1 January 2014.

Member State before the entry in force of this TSI.

Verification of the subsystem shall be carried out by the Assessing Entity

The EC verification of the subsystem shall be carried out by the Notified Body

against the requirements of Chapter 4 by using the corresponding requirements concerning assessment in Chapter 6 together with Chapter 7 except for specific cases. For this verification the modules of the subsystem, set out in point 6.2.2, apply:

EC

declarations of conformity or suitability for use shall not be drawn up for the components assessed in this manner.

#### 6.4. **Project phases where assessment is required**

The assessment shall cover the following two phases as identified by “X” in the table F.1 of Appendix F in this

UTP

TSI

In particular, where a type test is identified the conditions and requirements of section 4.2 shall be considered.

(a) Design and development phase:

- Design review and/or design examination
- Type test: test to verify the design, if and as defined in the section 4.2.

<sup>49</sup> The separate assessment and certification of ICs from the subsystem is generally not mandatory in COTIF, however CSs may require separate assessment. For non-certified ICs as described in this clause, CSs may not require separate assessment.

 <b>OTIF</b>	<b>ROLLING STOCK</b> <b>FREIGHT WAGONS</b>			<b>UTP WAG 2015</b> Page 53 of 133
	Status: <b>PROPOSAL</b>	Version: 04	TECH-16014-CTE9-5.1b	Original: EN

(b) Production phase:

- Routine test to verify the conformity of production. The entity in charge of the assessment of the routine tests is determined according to the assessment module chosen.

Appendix F is structured according to section 4.2. Where relevant, a reference to the points of sections 6.1 and 6.2 is given.

**6.5. Elements of construction holding a declaration of conformity**

**Constituents holding an EC declaration of conformity**

Where an element

Where a constituent

has been identified as an IC and held

either

an EC declaration of conformity

- a declaration of conformity issued in accordance with the UTP Wagons:2012<sup>50</sup>, or
- an EC declaration of conformity issued in accordance with EU regulations equivalent to the UTP Wagons:2012,

before

1 January 2014,

the entry into force of this TSI,

its treatment under this

UTP

TSI,

is set out as follows:

(a) In the case this constituent is not recognised as an IC in this

UTP,

TSI,

neither the certificate nor the declaration are valid for the verification procedure related to this

UTP.

TSI.

(b) The

certificates issued in accordance with the UTP WAG:2012, or the equivalent

<sup>50</sup> A 94-02/3.2011

 <b>OTIF</b>	<b>ROLLING STOCK</b> <b>FREIGHT WAGONS</b>			<b>UTP WAG 2015</b> Page 54 of 133
	Status: <b>PROPOSAL</b>	Version: 04	TECH-16014-CTE9-5.1b	Original: EN

EC certificates of conformity, EC-type examination certificates and EC-design examination certificates of the following ICs shall remain valid under this

UTP	TSI
-----	-----

until their expiry:

- Wheelset;
- Wheel;
- Axle.

## 7. IMPLEMENTATION

7.1. <b>Admission to operation</b>	<b>Authorisation for placing in service</b>
------------------------------------	---------------------------------------------

This

UTP	TSI
-----	-----

is applicable to the subsystem “rolling stock - freight wagons” within the scope set out in its sections 1.1, 1.2 and Chapter 2 which are placed in service after the date of

1 January 2014.	application of this TSI.
-----------------	--------------------------

7.1.1. <i>Admission to operation of a new vehicle in conformity with the previous WAG UTP.</i>	<i>Authorisation for placing in service of a new vehicle in conformity with the previous WAG TSIs</i>
------------------------------------------------------------------------------------------------	-------------------------------------------------------------------------------------------------------

See Section 0.	See Article 9.
----------------	----------------

7.1.2. <i>Mutual recognition of the first admission to operation</i>	<i>Mutual recognition of the first authorisation of placing in service</i>
----------------------------------------------------------------------	----------------------------------------------------------------------------

Without prejudice to specific cases, vehicles which are admitted to operation in a Contracting State and which fully meet the conditions set out in a) to k) shall not be subject to any additional admission to operation in OTIF Contracting States.

Without prejudice to specific cases, vehicles which are authorised for placing in service in a Contracting State which is also an EU Member State according to Article 22 of Directive 2008/57/EC and which fully meet the conditions set out in section 7.1.2 of TSI

In accordance with Article 23(1) of Directive 2008/57/EC the following list lays out the conditions under which a unit, once authorised for placing in service in one Member State, shall not be subject to any additional authorisation for placing in service. These conditions shall be seen as complementary to the requirements in section 4.2. These following conditions must be fulfilled in their entirety:

 <b>OTIF</b>	<b>ROLLING STOCK</b> <b>FREIGHT WAGONS</b>		<b>UTP WAG 2015</b> <b>Page 55 of 133</b>	
	Status: <b>PROPOSAL</b>	Version: 04	TECH-16014-CTE9-5.1b	Original: EN

WAG:2013 shall not be subject to any additional admission to operation in OTIF Contracting States.

These conditions shall be seen as complementary to the requirements in section 4.2.

- a) The running dynamic behaviour of the unit must have been assessed to the full range of track geometric qualities and all combinations of speed, curvature, cant deficiency set out in EN 14363:2005 (point 4.2.3.5.2).  
Alternatively the unit must be equipped with running gear, either certified or established, in accordance with point 6.1.2.1.
- b) The axle bearing condition must be possible to be monitored by line side detection equipment of the network the unit is intended to be operated on considering the conditions of clauses 4.2.3.4.
- c) The unit must not be equipped with variable gauge wheelsets (point 4.2.3.6.6).
- d) The unit must be equipped with forged and rolled wheels assessed according to point 6.1.2.3 a).
- e) The compliance/non-compliance with the requirements regarding the axle bearing condition monitoring by line side equipment as set out in point 7.3.2.2. a) must be recorded in the technical file.
- f) Units intended to operate on the 1668 mm track gauge network must comply with the requirements regarding the axle bearing condition monitoring by line side equipment as set out in point 7.3.2.2 b).
- g) The reference profile established for the unit as per point 4.2.3.1 must be allocated to one of the target reference profile(s) G1, GA, GB and GC including those used for the lower part GIC1 and GIC2.
- h) The unit must be compatible with the train detection systems based on track circuits, on axle counters and loop equipment

where the values of the parameters set out in clauses 4.2.3.3(a), 4.2.3.3(b) and 4.2.3.3(c) shall be as defined in Appendix H of this UTP.

as specified in clauses 4.2.3.3(a) and 4.2.3.3(b) and 4.2.3.3(c).

- i) The unit must be equipped with the manual coupling system in accordance with the prescriptions set out in Appendix C section 1 including the fulfilment of section 8 or with any semi-automatic or automatic standardised coupling system.
- j) The brake system must be in accordance with the conditions of Appendix C sections 9, 14 and 15 when applying the reference case set out in point 4.2.4.2. ~~If the brake system requires brake blocks acting on the wheel tread, only the brake blocks listed in Appendix G shall be used.~~
- k) The unit must be marked with all applicable markings in accordance with EN 15877-1:2012, in particular with the marking on:
  - (i) the allocated interoperable gauge,
  - (ii) the vehicle tare weight,

 <b>OTIF</b>	<b>ROLLING STOCK</b> <b>FREIGHT WAGONS</b>			<b>UTP WAG 2015</b> <b>Page 56 of 133</b>
	<b>Status: PROPOSAL</b>	<b>Version: 04</b>	<b>TECH-16014-CTE9-5.1b</b>	<b>Original: EN</b>

- (iii) the vehicle load table,
- (iv) the length over buffers,
- (v) the maintenance dates,
- (vi) the lifting and re-railing signs,
- (vii) the distance between the two end axles of the unit,
- (viii) the distance between bogie centres,
- (ix) the brake weight and
- (x) the track gauge(s) the unit is compatible with and was assessed for.

## 7.2. Substitution, renewal and upgrading

This section deals with

- substitutions of
 

elements of construction (ICs) as defined in Article 2(g) of ATMF, (Appendix G to the Convention)	constituents as referred to in Article 2(p) of Directive 2008/57/EC and
---------------------------------------------------------------------------------------------------	-------------------------------------------------------------------------
- the renewal or upgrading of freight wagons, including the substitution of elements within a unit, in accordance with the conditions laid down in
 

Article 10 § 11 of ATMF (Appendix G to the Convention)	Article 20 of Directive 2008/57/EC.
--------------------------------------------------------	-------------------------------------

Concerning the substitution of constituents the following categories have to be considered.

- Certified ICs: Components which correspond to an IC in Chapter 5 and which are holding a certificate of conformity.
- Other components: Any component, which is not corresponding to an IC in Chapter 5.
- Non-certified ICs: Components which correspond to an IC in Chapter 5 but are not holding a certificate of conformity and which are produced before the expiry of the transitional period referred to in section 6.3.

Table 11 shows the possible permutations.

*Table 11*  
**Substitution permutation table**

	substituted by		
	certified ICs	other components	non-certified ICs
<b>Certified ICs...</b>	check	not possible	Check
<b>Other components...</b>	not possible	check	not possible
<b>Non-certified ICs...</b>	check	not possible	Check



 <b>OTIF</b>	<b>ROLLING STOCK FREIGHT WAGONS</b>			<b>UTP WAG 2015</b> Page 57 of 133
	Status: <b>PROPOSAL</b>	Version: 04	TECH-16014-CTE9-5.1b	Original: EN

The word “check” in table 11 means that the entity in charge of maintenance (ECM) may under its responsibility substitute a component by another one utilising the same function and performance in accordance with the relevant

UTP. | TSI.

requirements considering these components are

- suitable, i.e. conform to the relevant

UTP(s). | TSI(s).

- used within its area of use,
- enabling interoperability,
- meeting the essential requirements and
- in line with restrictions eventually stated in the technical file.

When the extent of the work leads to a different function or performance or in case of a substitution of an element within the unit, the contracting entity or the manufacturer is required to send the

Contracting State(s) where the vehicle was first permitted to operate a file describing the project as set out in Article 10 § 11 of ATMF (Appendix G to the Convention).

The Contracting State(s) shall decide whether a new admission to operation is needed.

Member State concerned a file describing the project as set out in Article 20 of Directive 2008/57/EC. The Member State decides whether a new authorisation for placing in service is needed.

### 7.3. **Specific cases**

#### 7.3.1. *Introduction*

The specific cases, as listed in point 7.3.2, are classified as:

- “P” cases: “permanent” cases.
- “T” cases: “temporary” cases, where it is recommended that the target system is reached by 2020

(an objective set in Decision 2010/661/EU of the European Parliament and of the Council of 7 July 2010 on Union guidelines for the development of the trans-European transport network<sup>51</sup>).

<sup>51</sup> OJ L 204, 5.8.2010, p. 1.

 <b>OTIF</b>	<b>ROLLING STOCK</b> <b>FREIGHT WAGONS</b>			<b>UTP WAG 2015</b> Page 58 of 133
	Status: <b>PROPOSAL</b>	Version: 04	TECH-16014-CTE9-5.1b	Original: EN

7.3.2. *List of specific cases*

Specific cases for Contracting States which are also EU Member States are those which are included in the WAG TSI:2013.

*(see section 7.3.2.1 of WAG TSI:2013)*

7.4. **Specific environmental conditions**

Specific environmental conditions for Contracting States which are also EU Member States are those which are included in the WAG TSI:2013.

*(see section 7.4 of WAG TSI:2013)*

7.5. **Freight wagons operating under national, bilateral, multilateral or international agreements**

Not applicable within the scope of this UTP.

*(see section 7.5 of WAG TSI:2013)*

 <b>OTIF</b>	<b>ROLLING STOCK</b> <b>FREIGHT WAGONS</b>		<b>UTP WAG 2015</b> <b>Page 59 of 133</b>	
	Status: <b>PROPOSAL</b>	Version: 04	TECH-16014-CTE9-5.1b	Original: EN

### Appendix A: Open Points

Certain technical aspects, corresponding to the essential requirements, which are not explicitly covered by the specifications, are open points. These are stipulated in sections 4.2 and 6.2 and listed in table A.1.

*Table A.1*

#### *List of open points*

<b>Element of the Rolling Stock sub-system</b>	<b>Point</b>	<b>Technical aspect not covered by this UTP / TSI</b>	<b>Link to other subsystems to cover the open point</b>
Axle bearing condition monitoring	4.2.3.4	Option on board equipment	Equipment not mandatory.
Test conditions for on-track tests as set out in the EN 14363 are not always fully achievable	6.2.2.3 (4.2.3.5.2)	track geometric quality and combinations of speed, curvature, cant deficiency (point 5.4.2 of EN 14363).	
Variable gauge wheelsets	4.2.3.6.6	Assessment concerning the following requirement: The changeover mechanism of the variable gauge wheelset shall ensure the safe locking in the correct intended axial position of the wheel and any brake equipment attached.	
<del>Composite brake blocks in Appendix G</del>	<del>7.1.2 C.14</del>	<del>EU: Assessment by a notified body OTIF: Assessment by a Assessing Entity</del>	

 <b>OTIF</b>	<b>ROLLING STOCK</b> <b>FREIGHT WAGONS</b>		<b>UTP WAG 2015</b> <b>Page 60 of 133</b>	
	Status: <b>PROPOSAL</b>	Version: 04	TECH-16014-CTE9-5.1b	Original: EN

## **Appendix B: Specific procedures for running dynamics**

*This appendix is a transcription of ERA technical document ERA/TD/2013/01/INT version 1.0 of 11.02.2013 published on the ERA website and referred to in the WAG TSI. It appears in full width in order that the drawings remain legible.*

### **1. Specific assessment concerning running dynamic testing following EN 14363**

#### **1.1. Conditions for testing on one rail inclination**

- The parameter equivalent conicity  $\tan \gamma_e$  for tangent track and large radius curves shall be distributed so that  $\tan \gamma_e = 0,2 \pm 0,05$  occurs in a range of the amplitude (y) of the wheelsets lateral displacement between +/-2 and +/-4 mm for a minimum of 50% of track sections.
- The instability criterion in EN14363:2005 shall be assessed for low-frequency body motions on at least two track sections with equivalent conicities less than 0.05 (mean value over the track sections).
- The instability criterion in EN14363:2005 shall be assessed on at least two track sections with equivalent conicities in accordance with table B.1.

*Table B.1*

*Conditions for contact conditions in relation to on-track testing*

<b>Maximum vehicle speed</b>	<b>Equivalent conicity</b>
60 km/h < V ≤ 140 km/h	≥0,50
140 km/h < V ≤ 200 km/h	≥0,40
200 km/h < V ≤ 230 km/h	≥0,35
230 km/h < V ≤ 250 km/h	≥0,30

#### **1.2. Limit values for running safety**

The limit values for running safety specified in clause 5.3.2.2 of EN 14363:2005 and for axle loads above 22,5 t in clause 5.3.2.2 of EN 15687:2010 shall be met and verified.

When the quotient of guiding force and wheel force (Y/Q) limit is exceeded, it is allowed to recalculate the Y/Q estimated maximum value in accordance with the following process:

- create an alternative test zone made up of all track sections with  $300 \text{ m} \leq R \leq 500 \text{ m}$ ,
- for the statistical processing per section, use  $x_i$  (97,5%) instead of  $x_i$  (99,85%),
- for statistical processing per zone, replace  $k=3$  (when using one-dimensional method) or Student coefficient  $t$  (N-2; 99%) (when using two-dimensional method) by Student coefficient  $t$  (N-2; 95%).

Both results (before and after recalculation) shall be reported.

#### **1.3. Track loading limit values**

The limit values for track loading specified in EN 14363:2005 clause 5.3.2.3 and for loads above 22,5 t in EN 15687:2010 clause 5.3.2.2 shall be met and verified when so required by the methodology of EN 14363:2005.

The quasi-static guiding force  $Y_{qst}$  limit value shall be evaluated for curve radii  $250 \leq R < 400 \text{ m}$ .

 <b>OTIF</b>	<b>ROLLING STOCK</b> <b>FREIGHT WAGONS</b>		<b>UTP WAG 2015</b> <b>Page 61 of 133</b>	
	Status: <b>PROPOSAL</b>	Version: 04	TECH-16014-CTE9-5.1b	Original: EN

The limit value shall be:

- $(Y_{qst})_{lim} = (30 + 10500/R_m)$  kN
- $(Y_{qst})_{lim} = (33 + 11550/R_m)$  kN for the 1668 mm track gauge network,

where  $R_m$  = mean radius of the track sections retained for the evaluation.

When this limit value is exceeded due to high friction conditions, it is permitted to recalculate the estimated value of  $Y_{qst}$  on the zone after replacing the individual  $(Y_{qst})_i$  values on the track sections "i" where  $(Y/Q)_{ir}$  (mean value of Y/Q ratio on the inner rail over the section) exceeds 0,40 by:  $(Y_{qst})_i - 50[(Y/Q)_{ir} - 0,4]$ . Both results (before and after recalculation) shall be reported.

The values of the  $Y_{qst}$ ,  $Q_{qst}$  and mean curve radius (before and after recalculation) shall be recorded in the test report.

In case the  $Y_{qst}$  value exceeds the limit value expressed above, the operational performance of the unit (e.g. maximum speed) may be limited by the network, considering track characteristics (e.g. curve radius, cant, rail height).

## 2. Qualification of running gear

Following successful testing the acceptable parameter variation range is given by the range between the nominal tested parameters extended as illustrated in figure B.2.

It is permitted to perform only one test and by doing so only validating the running gear for a limited range.

Fig. B.2

*Parameter variation ranges for the acceptance after successful testing compared to the process in EN 14363:2005*

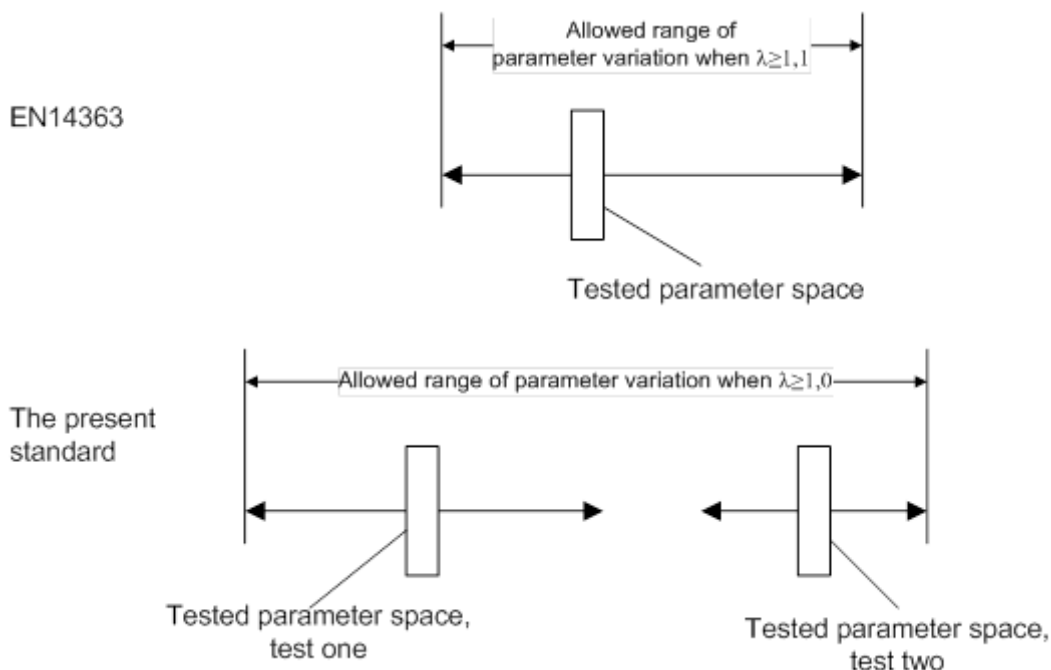

 <b>OTIF</b>	<b>ROLLING STOCK</b> <b>FREIGHT WAGONS</b>			<b>UTP WAG 2015</b> Page 62 of 133
	Status: <b>PROPOSAL</b>	Version: 04	TECH-16014-CTE9-5.1b	Original: EN

## 2.1. Test extent

The tests shall be carried out in accordance with the complete procedure in chapter 5 of EN14363:2005, considering the specific procedures as set out in Appendix B.1.

Units with an axle load higher than 22,5 t up to 25 t shall be tested in accordance with EN 15687:2010.

The tests shall be performed for the same intended operating conditions ( $v_{adm}$  and  $I_{adm}$ ):

- One test with a wagon of short running gear distance.
- One test with a wagon of long running gear distance

Other values of body parameters shall be within the ranges defined in table B.3.

*Table B.3*

**Body parameters**

		2-axle wagons		Bogie wagons	
		Short test wagon	Long test wagon	Short test wagon	Long test wagon
<b>Distance between running gear</b>	$2a^*$ [m] <sup>a)</sup>	$\leq 7$	$\geq 9$	$\leq 7$	$\geq 13$
<b>Acceptable range of torsional coefficient of vehicle body</b>	$c_t^*$ [kNmm <sup>2</sup> /rad]	0,5 x10 <sup>10</sup> ... 8 x10 <sup>10</sup>			
a) 2a* is the distance between wheelsets for 2-axle wagons or the distance between bogies for bogie wagons and ct* is the vehicle body torsional stiffness coefficient.					

Note 1:

For the purposes of assessment of running behaviour a typical loading condition must be tested. It is not necessary to test the worst position of the centre of gravity.

In addition, two axle wagons for speeds  $\geq 100$  km/h shall be tested in loaded condition also in sections of test zone 2 with clearances given by a gauge of  $\geq 1450$  mm in combination with wheelsets having distances between active faces at the minimum operation limit.

If the design parameters and the operation parameters require the application of the normal measuring method, it is nevertheless acceptable to perform such tests with one of the vehicles based on measurements of lateral acceleration. In that case, it shall be demonstrated that a relationship exists between accelerations and the sum of the guiding forces on the vehicle tested according to the normal measuring method and a related limit value shall be established.

Note 2:

This requirement is an extension of the application of the simplified measuring method, using information gathered with vehicle tested according to the normal measuring method.

Note 3:

 <b>OTIF</b>	<b>ROLLING STOCK</b> <b>FREIGHT WAGONS</b>			UTP WAG 2015 Page 63 of 133
	Status: <b>PROPOSAL</b>	Version: 04	TECH-16014-CTE9-5.1b	Original: EN

This requirement is intended to be transferred to the test conditions in EN 14363:2005.

## 2.2. Range of running gear parameters for dispensation from on-track tests

Following successful testing in accordance with Appendix B section 2.1 the acceptable parameter variation range for dispensation from on-track tests is given by the range between the nominal tested parameters of the running gear and the extended range as illustrated in figure B.2 and specified in tables B.4 and B.5.

All parameters given in these tables are nominal values. The upper limit of the acceptable range depends on the maximum tested value of the respective parameter, the lower limit on the minimum tested value.

In case of extension of the already applicable parameter range of a running gear, new tests shall be performed with parameters outside the previously tested range.

*Table B.4*

*Accepted parameter ranges for a single axle running gear which was tested successfully in accordance with Appendix B section 2.1*

Nominal parameter		Minimum	Maximum
Maximum axle load	P	-	$P_{\text{tested}}$
Vertical eigenfrequency	$v_z$	0.9 $v_z$ in load range	1.12 $v_z$ in load range
Vertical damping		Nominal characteristics of tested running gear	
Lateral and longitudinal suspension characteristics		Nominal characteristics of tested running gear	
Distance between centres of axle bearings (suspension base)	2bz	$2b_{z, \text{tested}} - 100 \text{ mm}$	$2b_{z, \text{tested}} + 170 \text{ mm}$
Wheel diameter	D	Diameter of tested application $D_{\text{tested}} - 90 \text{ mm}$	Diameter of tested application $D_{\text{tested}} + 90 \text{ mm}$

 <b>OTIF</b>	<b>ROLLING STOCK</b> <b>FREIGHT WAGONS</b>		<b>UTP WAG 2015</b> <b>Page 64 of 133</b>	
	Status: <b>PROPOSAL</b>	Version: 04	TECH-16014-CTE9-5.1b	Original: EN

Table B.5

*Accepted parameter ranges for a bogie which was tested successfully in accordance with Appendix B section 2.1*

Nominal parameter		Minimum	Maximum
Maximum axle load	$P_{\max}$	-	$1,05 \cdot P_{\max, \text{tested}}$
Bogie axle distance (between outer axles of the bogie)	$2a^+$	$2a^+_{\text{tested}}$	$2a^+_{\text{tested}} + 0,2 \text{ m}$
Vertical eigenfrequency (see Appendix C)	$v_z$	$0,90 \cdot v_{z, \text{tested}}$ in full range between empty and loaded conditions	$1,12 \cdot v_{z, \text{tested}}$ in full range between empty and loaded conditions
Vertical Damping		Nominal characteristics of tested running gear	
Axle guiding longitudinal		Nominal characteristics of tested running gear	
Axle guiding lateral		Nominal characteristics of tested running gear	
Lateral secondary susp. characteristics		Nominal characteristics of tested running gear	
Distance between centres of axle bearings (suspension base)	$2bz$	$2bz, \text{ tested } -100 \text{ mm}$	$2bz, \text{ tested } +170 \text{ mm}$
Yaw resistance of bogie <sup>a)</sup>	$M_z^*$	$0,80 \cdot M_{z, \text{tested}}^*$	$1,20 \cdot M_{z, \text{tested}}^*$
Moment of inertia of whole bogie (around z-axis)	$I_{zz}^*$	-	$1,10 \cdot I_{zz, \text{tested}}^*$
Wheel diameter	$D$	$D_{\text{tested}} - 90 \text{ mm}$	$D_{\text{tested}} + 90 \text{ mm}$
Nominal height of centre pivot	$h_{cp}$	$h_{cp, \text{tested}} - 150 \text{ mm}$	$h_{cp, \text{tested}} + 50 \text{ mm}$
<sup>a)</sup> for a friction based yaw resistance torque measured at two specified loads typical for empty and loaded condition. For other systems, appropriate parameters must be used to control stability and safety against derailment in empty condition and maximum guiding force in loaded conditions.			

### 2.3 Range of vehicle body parameters for dispensation from on-track tests

Following successful testing according to Appendix B section 2.1 the acceptable parameter variation range for a dispensation from on-track tests is given by the range between the nominal tested parameters of the vehicle body and the extended range where applicable as specified in table B.6. All parameters given in this table are nominal values. The upper limit of the acceptable range depends on the maximum tested value of the respective parameter, the lower limit on the minimum tested value.

To extend the applicable vehicle parameter range of a standardised running gear, test results of a third tested vehicle outside the previously tested range shall be used.





 <b>OTIF</b>	<b>ROLLING STOCK</b> <b>FREIGHT WAGONS</b>		<b>UTP WAG 2015</b> <b>Page 65 of 133</b>	
	Status: <b>PROPOSAL</b>	Version: 04	TECH-16014-CTE9-5.1b	Original: EN

Table B.6

*Accepted parameter range for vehicles (including articulated wagons and permanently coupled units) equipped with a running gear which was tested successfully according to Appendix B section 2.1*

Nominal parameter		Minimum	Maximum
Distance between wheelsets (non bogie vehicles)	$2a^*$	Lowest value of either 6 m or $2a^*_{\text{tested}}$	Highest value of either 10 m or $2a^*_{\text{tested}}$
Distance between centres bogies (bogie vehicles)	$2a^*$	Lowest value of either 6,5 m or $2a^*_{\text{tested}}$	$2a^*_{\text{tested}} + 3\text{m}$
Centre of gravity height of empty wagon	$h_{\text{cg}}$	-	$1,2 \cdot h_{\text{cg,empty,tested, max}}$
Coefficient of height of centre of gravity - loaded vehicle <sup>a)</sup>	$\chi$	-	$\chi_{\text{loaded,tested,max}} \times (1+0,8(\lambda'-1))$ with $\lambda'$ – factor for track loading parameters.
Torsional coefficient per vehicle body	$c_t^*$	$> 0,5 \cdot 10^{10} \text{ kNmm}^2/\text{rad}$	-
Mean axle load of the tare unit (non-bogie wagon)	$P_{\text{mean,tare}}$	Smallest value of either 5,75 t or $P_{\text{mean,tare,tested}}$	-
Mean axle load of the tare unit (bogie wagon)	$P_{\text{mean,tare}}$	Smallest value of either 4 t or $P_{\text{mean,tare,tested}}$	-
Maximum axle load	$P$	-	$1,05 \cdot P_{\text{tested}}$
Mass distrib. coefficient (empty and loaded vehicle)	$\Phi$	-	$1,2 \cdot \Phi_{\text{tested}}$
<sup>a)</sup> for evaluation of $\chi$ use admissible cant deficiency of 130 mm for axle loads $\leq 225 \text{ kN}$ and 100 mm for axle loads $> 225 \text{ kN}$ and up to 250 kN.			

 <b>OTIF</b>	<b>ROLLING STOCK</b> <b>FREIGHT WAGONS</b>		<b>UTP WAG 2015</b> <b>Page 66 of 133</b>	
	Status: <b>PROPOSAL</b>	Version: 04	TECH-16014-CTE9-5.1b	Original: EN

### **Appendix C: Additional optional conditions**

The compliance with the following set of conditions C.1 to C.18 is optional. If the applicant selects this option,

an Assessing Entity has to assess compliance within the	a notified body has to assess the compliance within the EC
---------------------------------------------------------	------------------------------------------------------------

verification procedure.

#### **1. Manual coupling system**

The manual coupling system shall comply with the following requirements:

- The screw coupling system excluding the draw hook shall comply with the requirements related to freight wagons of EN15566:2009+A1:2010 except clause 4.4,
- The draw hook shall comply with the requirements related to freight wagons of EN15566:2009+A1:2010 except clause 4.4 and except the dimension “a” in Annex A Figure A.1 which shall be treated as informative.
- The draw hook shall be located at a height between 920 and 1045 mm above rail level in all loading and wear conditions.
- The centreline of the draw hook shall be located within a range of 0 to 20mm below the buffing centre.
- The clearance for the draw hook shall be in accordance with

Appendix K

Appendix K	chapter 2 of ERA technical document ERA/TD/2012-04/INT version 1.2 of 18.01.2013 published on the ERA website <a href="http://www.era.europa.eu">http://www.era.europa.eu</a> .
------------	------------------------------------------------------------------------------------------------------------------------------------------------------------------------------------------

- The buffer shall comply with the requirements related to freight wagons of EN15551:2009+A1:2010.
- The buffing centre line shall be located at a height between 940 and 1065 mm above rail level in all loading and wear conditions.
- There shall be no fixed parts within 40 mm of a vertical plane placed at the end of the fully compressed buffers.
- The space for shunting staff operation shall be in accordance with

Appendix L

Appendix L	chapter 3 of ERA technical document ERA/TD/2012-04/INT version 1.2 of 18.01.2013 published on the ERA website <a href="http://www.era.europa.eu">http://www.era.europa.eu</a> .
------------	------------------------------------------------------------------------------------------------------------------------------------------------------------------------------------------

- Where a combined automatic and screw coupler is fitted, it is permissible for the auto coupler head to infringe the space specified above for shunting staff on the left hand side when it is stowed and the screw coupler is in use. In this case the marking in figure 75 of EN15877-1:2012 is mandatory.

Interaction of buffers and draw gear

 <b>OTIF</b>	<b>ROLLING STOCK</b> <b>FREIGHT WAGONS</b>		<b>UTP WAG 2015</b> <b>Page 67 of 133</b>	
	Status: <b>PROPOSAL</b>	Version: 04	TECH-16014-CTE9-5.1b	Original: EN

- The characteristics of the buffers and draw gear shall be designed in order to enable the safe transit of curves in the track with a radius of 150 m. Two units with bogies coupled on straight track with touching buffers shall generate compressive forces not higher than 250 kN on a 150 m radius curve. There is no requirement specified for two axle units.
- The distance between the front edge of a draw-hook opening and the front side of the fully extended buffers shall be 355 mm +45/-20 mm in the new condition as shown in Figure C.1:

*Fig. C.1*  
*Configuration of buffers and draw gear*

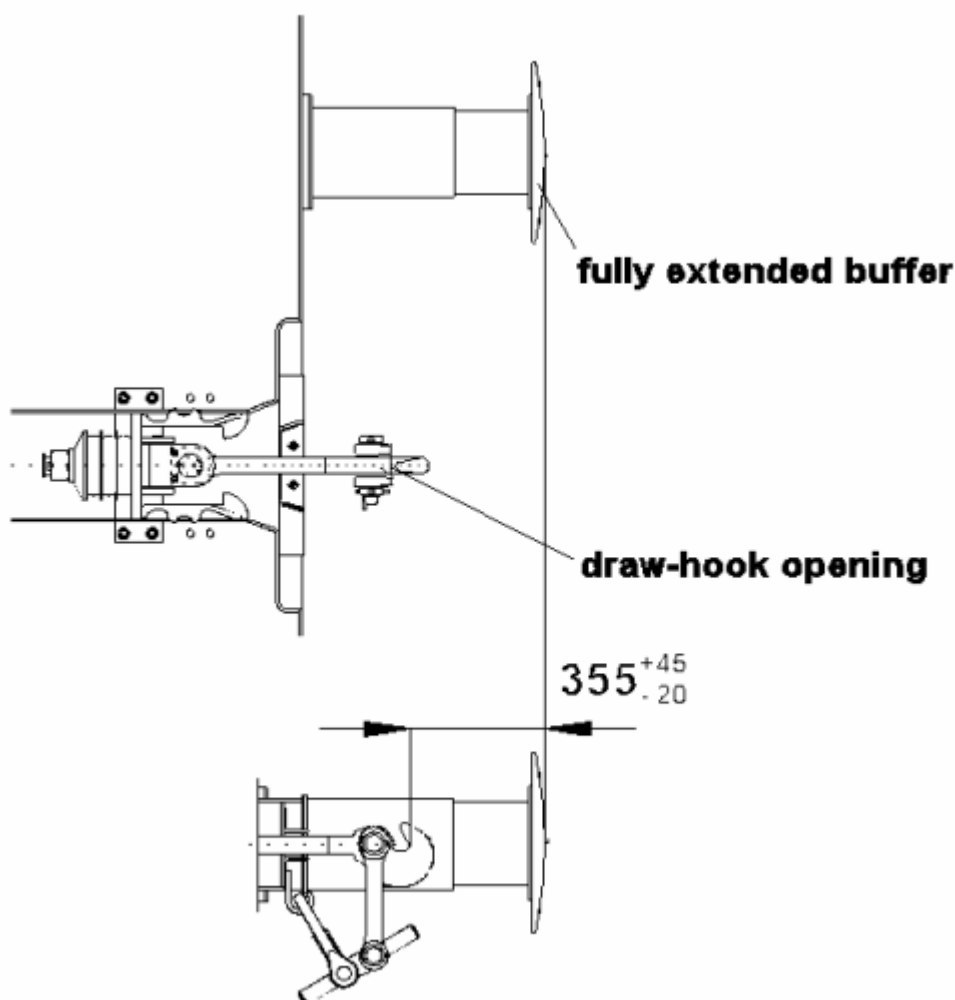

Units designed for 1435 mm and 1520 mm or 1435 mm and 1524 mm, or 1435 mm and 1668 mm gauge network(s), equipped with manual coupling and “UIC” pneumatic brake system, shall be compatible with both,

- the interface requirements for “End Coupling” mentioned before, and
- specific buffer layouts related to broad gauge networks.

 <b>OTIF</b>	<b>ROLLING STOCK</b> <b>FREIGHT WAGONS</b>		<b>UTP WAG 2015</b> Page 68 of 133	
	Status: <b>PROPOSAL</b>	Version: 04	TECH-16014-CTE9-5.1b	Original: EN

In order to provide this full compatibility, it is permitted to have a different value of the distance between buffer centrelines, 1790 mm (Finland) and 1850 mm (Portugal and Spain) taking into account clause 6.2.3.1 of EN 15551:2009+A1:2010.

## 2. UIC footsteps and handrails

The unit shall be equipped with footsteps and handrails in accordance with

Appendix M

chapter 4 of ERA technical document  
ERA/TD/2012-04/INT version 1.2 of  
18.01.2013 published on the ERA website  
(<http://www.era.europa.eu>).

## 3. Ability to be hump shunted

In addition to the requirements of point 4.2.2.2 the unit shall be assessed in accordance with clause 8 of EN 12663-2:2010 and classified in Category F I in accordance with clause 5.1 of EN 12663-2:2010 with the following exception: for units designed to carry motor vehicles or combined transport units without long stroke shock absorbers the Category F-II may be used. The requirements concerning the buffing tests in clause 8.2.5.1 of EN 12663-2:2010 apply.

## 4. Free space under lifting points

The unit shall comply with figure C.2 on the free space under the re-railing places for re-railing:

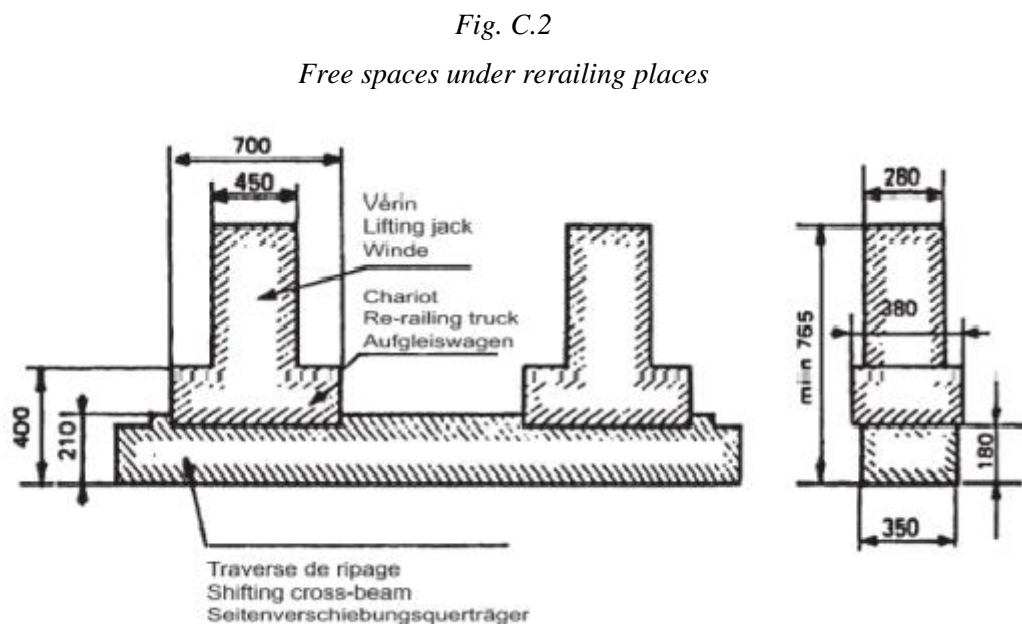

## 5. Marking of units

Markings of EN 15877-1:2012 are required where applicable. The following are always applicable:

- 4.5.2 Gauge marking
- 4.5.3 Vehicle Tare Weight

 <b>OTIF</b>	<b>ROLLING STOCK</b> <b>FREIGHT WAGONS</b>		<b>UTP WAG 2015</b> <b>Page 69 of 133</b>	
	Status: <b>PROPOSAL</b>	Version: 04	TECH-16014-CTE9-5.1b	Original: EN

- 4.5.4 Vehicle load table
- 4.5.5 Sign for length over buffers
- 4.5.12 Table of Maintenance dates
- 4.5.14 Lifting and re-railing signs
- 4.5.23 Distances between end axles and bogie centres
- 4.5.29 Brake weight

Units compliant with all requirements set out in section 4.2, fulfilling all conditions set out in point 7.1.2 and all conditions set out in Appendix C may receive the marking “GE”.

Wagons of the existing fleet which have been authorised in the EU in accordance with

- Commission Decision 2006/861/EC as amended by Decision 2009/107/EC or with
- Decision 2006/861/EC as amended by Decisions 2009/107/EC and 2012/464/EU and meeting the conditions set out in point 7.6.4 of Decision 2009/107/EC,

Or which have been admitted to operation in accordance with

- UTP WAG with reference A 94-02/3.2011 of 1.12.2012 and meeting the conditions set out in point 7.6.4 of that UTP,

may receive this marking “GE” without any additional third party assessment or new admission to operation. The use of this marking on wagons in operation remains under the responsibility of the railway undertakings.

<sup>(52)</sup>

wagons of the existing fleet which have been authorised in accordance with Commission Decision 2006/861/EC as amended by Decision 2009/107/EC or with Decision 2006/861/EC as amended by Decisions 2009/107/EC and 2012/464/EU and meeting the conditions set out in point 7.6.4 of Decision 2009/107/EC may receive this marking “GE” without any additional third party assessment or new authorisation for placing in service. The use of this marking in wagons in operation remains under the responsibility of the railway undertakings.

Units compliant with all requirements set out in section 4.2, fulfilling all conditions in point 7.1.2 and the conditions set out in Appendix C but not those set out in Appendix C sections 3 and/or 6 and/or 7.b may receive the marking “CW”.

If the additional marking is used, it shall be inscribed on the unit as outlined in figure C.3.

<sup>52</sup> Article 3(c) of Commission Regulation (EU) No 321/2013 enacting the WAG TSI

 <b>OTIF</b>	<b>ROLLING STOCK</b> <b>FREIGHT WAGONS</b>		<b>UTP WAG 2015</b> <b>Page 70 of 133</b>	
	Status: <b>PROPOSAL</b>	Version: 04	TECH-16014-CTE9-5.1b	Original: EN

*Fig. C.3*  
*The additional markings “GE” and “CW”*



The letters shall be of the same font type as the TEN marking. The size of the letters shall be at least 100 mm high. The outer measures of the frame shall be at least 275 mm wide and 140 mm high, the frame shall be 7 mm thick.

The marking shall be located on the right hand side of the area containing the European Vehicle Number and the TEN marking.

**6. G1 gauge**

The reference contour with which the unit complies with shall be G1 and G1C1 determined as defined in point 4.2.3.1.

**7. Compliance with core UTP/TSI regarding train detection systems**

(a) The unit shall be compatible with the train detection systems based on track circuits, on axle counters and on loop equipment as specified in

section 7.1.2 (h), with the values as defined in Appendix H.<sup>53</sup> | clauses 4.2.3.3(a), 4.2.3.3(b) and 4.2.3.3(c).

(b) The distance between two adjacent axles of the unit shall not exceed 17500 mm.

**8. Tests concerning longitudinal compressive forces**

The verification of safe running under longitudinal compressive forces shall be in accordance with EN 15839:2012.

**9. UIC brake**

The brake system shall be compatible with vehicles equipped with UIC approved brake systems. The brake system of a unit is compatible with the UIC brake system if it fulfils the following requirements:

- (a) The unit shall be equipped with a pneumatic brake pipe with an inner diameter of 32 mm.
- (b) Brake modes have different brake application and release times and specific brake weight percentage.

---

<sup>53</sup> According to clause 7.1.2 and Appendix H, the distance between two adjacent axles shall not exceed 20000 mm and CW wagons must comply with this value. For wagons marked GE, this value in clause 7.1.2 and Appendix H is made stricter by the maximum value 17500 mm, as set out in point (b).

 <b>OTIF</b>	<b>ROLLING STOCK</b> <b>FREIGHT WAGONS</b>			<b>UTP WAG 2015</b> <b>Page 71 of 133</b>
	Status: <b>PROPOSAL</b>	Version: 04	TECH-16014-CTE9-5.1b	Original: EN

- (c) Every unit shall be fitted with a brake system having at least brake modes G and P. The brake modes G and P shall be assessed in accordance with UIC 540:2006.
- (d) The minimum braking performance for brake-modes G and P shall be in accordance with table C.3.
- (e) If a unit is equipped with a brake system having in addition further brake modes the assessment procedure as described in point 4.2.4.3.2.1 shall be carried out for these additional brake modes. The brake application time of the P brake mode in accordance with UIC 540:2006 are also valid for further brake modes.
- (f) The energy storage has to be designed in such way that after a brake application with the maximum brake cylinder pressure and the maximum unit specific brake cylinder stroke at any load state the pressure in the auxiliary reservoir must be at least 0,3 bar more than the brake cylinder pressure without the addition of any further energy. Details for standardised air reservoirs are set out in EN 286-3:1994 (steel) and EN 286-4:1994 (aluminium).
- (g) The pneumatic energy of the brake system shall not be used for other applications different than those related to braking purposes.
- (h) The distributor and distributor isolating device shall be in accordance with EN 15355:2008+A1:2010. At least one distributor shall be installed per 31m unit length.
- (i) The pneumatic half coupling:
- (i) The interface of the brake pipe shall be in accordance with EN 15807:2011.
  - (ii) The opening of the automatic air brake coupling head shall face the left when looking at the end of the vehicle.
  - (iii) The opening of the main reservoir coupling head shall face the right when looking at the end of the unit.
  - (iv) The end cocks shall be in accordance with EN 14601:2005+A1:2010.
- (j) The brake mode switching device shall be in accordance with UIC 541-1:2010 Appendix E.
- (k) Brake block holders shall be in accordance with UIC leaflet 542:2010.
- (l) If the brake system requires a “friction element for wheel tread brakes” interoperability constituent, the interoperability constituent shall, in addition to the requirements of point 6.1.2.5, comply with UIC leaflet 541-4:2010. The manufacturer of the friction element for wheel tread brakes, or his authorised representative established within the Union, shall in that case obtain the UIC approval.~~brake blocks acting on the wheel tread, only the brake blocks listed in Appendix G shall be used.~~
- (m) Slack adjusters shall be in accordance with
- |            |                                                                                                                                                                               |
|------------|-------------------------------------------------------------------------------------------------------------------------------------------------------------------------------|
| Appendix N | ERA technical document<br>ERA/TD/201205/INT version 1.0 of<br>04.06.2012 published on the ERA<br>website ( <a href="http://www.era.europa.eu">http://www.era.europa.eu</a> ). |
|------------|-------------------------------------------------------------------------------------------------------------------------------------------------------------------------------|
- (n) If the unit is equipped with a wheel slide protection system (WSP) it shall be in accordance with EN 15595:2009+A1:2011.



 <b>OTIF</b>	<b>ROLLING STOCK</b> <b>FREIGHT WAGONS</b>		<b>UTP WAG 2015</b> <b>Page 72 of 133</b>	
	Status: <b>PROPOSAL</b>	Version: 04	TECH-16014-CTE9-5.1b	Original: EN

Table C.3

**Minimum braking performance for brake modes G and P**

Braking mode	Command Equipment	unit type	Load status	Requirement for running speed at 100km/h		Requirement for running speed at 120km/h	
				Maximum braking distance	Minimum braking distance	Maximum braking distance	Minimum braking distance
Braking mode "p"	Changeover <sup>(9)</sup>	"S1" <sup>(2)</sup>	Empty	$S_{max} = 700m$ $\lambda_{min} = 65\%$ <sup>(1)</sup> $a_{min} = 0,60m/s^2$ <sup>(1)</sup>	$S_{min} = 390m,$ $\lambda_{max} = 125\%, (130\%)*,$ $a_{max} = 1,15m/s^2$	$S_{max} = 700m$ $\lambda_{min} = 100\%$ $a_{min} = 0,88m/s^2$	$S_{min} = 580m,$ $\lambda_{max} = 125\%, (130\%)*,$ $a_{max} = 1,08m/s^2$
			Inter-mediate	$S_{max} = 810m$ $\lambda_{min} = 55\%$ $a_{min} = 0,51m/s^2$	$S_{min} = 390m,$ $\lambda_{max} = 125\%,$ $a_{max} = 1,15m/s^2$		
			Loaded	$S_{max} = 700m$ $\lambda_{min} = 65\%$ $a_{min} = 0,60m/s^2$	$S_{min} = \text{Max} [(S = 480m,$ $\lambda_{max} = 100\%, a_{max} = 0,91m/s^2),$ (S obtained with a mean retardation force of 16,5 kN per axle)] <sup>(5)</sup> .		
	Variable load Relay <sup>(10)</sup>	"S2" <sup>(3)</sup>	Empty	$S_{max} = 480m$ $\lambda_{min} = 100\%$ <sup>(1)</sup> $a_{min} = 0,91m/s^2$ <sup>(1)</sup>	$S_{min} = 390m,$ $\lambda_{max} = 125\%, (130\%)*,$ $a_{max} = 1,15m/s^2$	$S_{max} = 700m$ $\lambda_{min} = 100\%$ $a_{min} = 0,88m/s^2$	$S_{min} = 580m,$ $\lambda_{max} = 125\%, (130\%)*,$ $a_{max} = 1,08m/s^2$
			Loaded	$S_{max} = 700m$ $\lambda_{min} = 65\%$ $a_{min} = 0,60m/s^2$	$S_{min} = \text{Max} [(S = 480m,$ $\lambda_{max} = 100\%, a_{max} = 0,91m/s^2),$ (S obtained with a mean retardation force of 16,5 kN per axle)] <sup>(6)</sup> .		
		Loaded (18t per axle for brake blocks)			$S_{max}^{(8)} = \text{Max} [S = 700m, \lambda_{max} = 100\%,$ $a_{max} = 0,88m/s^2],$ (S obtained with a mean retardation force of 16kN per axle)] <sup>(7)</sup> .		



 <b>OTIF</b>	<b>ROLLING STOCK</b> <b>FREIGHT WAGONS</b>			<b>UTP WAG 2015</b> <b>Page 73 of 133</b>
	<b>Status: PROPOSAL</b>	<b>Version: 04</b>	<b>TECH-16014-CTE9-5.1b</b>	<b>Original: EN</b>

Braking mode	Command Equipment	unit type	Load status	Requirement for running speed at 100km/h		Requirement for running speed at 120km/h	
				Maximum braking distance	Minimum braking distance	Maximum braking distance	Minimum braking distance
Braking mode "G"					There shall be no separate assessment of the braking performance of units in position G. A unit's braked weight in position G is the result of the braked weight in position P (see UIC 544-1:2013)		

\*only for two stage load brake (changeover command) and P10 (cast iron blocks with 10 ‰ phosphor)- or LL-brake blocks

- (1) "a" =  $((\text{Speed (Km/h)})/3,6)^2 / (2 \times (S - (T_e) \times (\text{Speed (Km/h)})/3,6))$ , with  $T_e = 2 \text{ sec}$ .  
Distance calculation EN 14531-1:2005 section 5.11
- (2) a unit "S1" is a unit with empty/load device. Maximum load per axle is 22,5 t.
- (3) a unit "S2" is a unit with a variable load relay. Maximum load per axle is 22,5 t.
- (4) a unit "SS" shall be equipped with a variable load relay. Maximum load per axle is 22,5 t.
- (5) The maximum mean retardation force admitted (for running speed at 100km/h) is  $18 \times 0,91 = 16,5 \text{ kN/axle}$ . This value comes from the maximum braking energy input permitted on a clasp braked wheel with a nominal new diameter in the range of [920 mm; 1 000 mm] during braking (the brake weight shall be limited to 18 tonnes/axle).
- (6) The maximum mean retardation force admitted (for running speed at 100km/h) is  $18 \times 0,91 = 16,5 \text{ kN/axle}$ . This value comes from the maximum braking energy input permitted on a clasp braked wheel with a nominal new diameter in the range of [920 mm; 1 000 mm] during braking (the brake weight shall be limited to 18 tonnes/axle). Usually a unit, with  $V_{\text{max}} = 100 \text{ km/h}$  and fitted with a variable relay is designed to obtain  $\lambda = 100\%$  up to 14.5 t/axle.
- (7) The maximum mean retardation force admitted (for running speed at 120km/h) is  $18 \times 0,88 = 16 \text{ kN/axle}$ . This value comes from the maximum braking energy input permitted on a clasp braked wheel with a nominal new diameter in the range of [920 mm; 1 000 mm] during braking (the brake weight shall be limited to 18 tonnes). The mass/axle is limited to 20 t/axle and the corresponding  $\lambda$  is 90%. If it is required  $\lambda > 100\%$  with mass/axle  $> 18 \text{ t}$  then it is necessary to consider another kind of brake.
- (8)  $\lambda$  must not exceed 125%, considering for brake only on wheels (brake blocks), the maximum mean retardation force admitted of 16 kN/axle (for running speed at 120km/h).
- (9) Changeover in accordance with EN 15624:2008+A1:2010.

 <b>OTIF</b>	<b>ROLLING STOCK</b> <b>FREIGHT WAGONS</b>		<b>UTP WAG 2015</b> <b>Page 74 of 133</b>	
	Status: <b>PROPOSAL</b>	Version: 04	TECH-16014-CTE9-5.1b	Original: EN

- (10) Variable load relay in accordance with EN 15611:2008+A1:2010 in combination with variable load sensing device in accordance with EN 15625:2008+A1:2010.

#### 10. Location of parking brake handles

If a unit is equipped with a parking brake the location of its operating handle or operating wheel shall be:

- on both sides of the unit if it is operated from the ground or
- on a platform, that can be accessed from both sides of the unit.

The operation from the ground shall be done by wheel.

#### 11. Temperature ranges for air reservoirs, hoses and grease

The following requirements are deemed to comply with the range T1 indicated in point 4.2.5.

- Air reservoirs shall be designed for the temperature range of -40°C to +100°C.
- Brake cylinders and brake couplings shall be designed for the temperature range of -40°C to +70°C.
- Hoses for air brakes and air supply shall be specified for the temperatures range -40°C to +70°C.
- The grease for the lubrication of roller bearing shall be specified for ambient temperatures down to -20°C.

#### 12. Welding

Welding shall be carried out in accordance with EN 15085-1-5:2007.

#### 13. Track gauge

The unit shall be compatible with the 1435 mm track gauge.

#### 14. Specific brake thermal capacity

The brake system shall resist a thermal load equivalent to the suggested reference case in point 4.2.4.3.3.

~~Concerning With regard to~~ the use of wheel tread brake systems this condition is deemed to be ~~fulfilled met~~, if the “friction elements for wheel tread brakes” interoperability constituent is, in addition to the requirements of point 6.1.2.5, compliant with UIC leaflet 541-4:2010, brake block

~~is listed in Appendix G and~~

~~is used within its area of use as described in Appendix G~~

and if the wheel:

- is assessed in accordance with point 6.1.2.3 and
- fulfils the conditions of Ssection 15 of Appendix C.

#### 15. Specific product properties concerning the wheel

The wheels shall be in accordance with EN 13262:2004+A1:2008+A2:2011 and EN 13979-1:2003+A1:2009+A2:2011. The thermal mechanical type test required in point 6.1.2.3 shall be carried out in accordance with table C.4 when the complete brake system is acting directly on the wheel tread.

 <b>OTIF</b>	<b>ROLLING STOCK</b> <b>FREIGHT WAGONS</b>			<b>UTP WAG 2015</b> <b>Page 75 of 133</b>
	Status: <b>PROPOSAL</b>	Version: 04	TECH-16014-CTE9-5.1b	Original: EN

*Table C.4*

*Conditions for the thermal mechanical type test*

<b>Wheel diameter range [mm]</b>	<b>1000 - 920</b>	<b>920 - 840</b>	<b>840 - 760</b>	<b>760 - 680</b>
Standard power value	50 kW	50 kW	42,5 kW	38 kW
Application time	45 min	45 min	45 min	45 min
Running speed	60 km/h	60 km/h	60 km/h	60 km/h

**16. Tow hooks**

Units shall be provided with tow hooks, each one being fixed to the side of the unit underframe in accordance with clause 1.4 of UIC 535-2:2006.

**17. Protective devices on protruding parts**

To ensure the safety of staff, protruding (e.g. angular or pointed) parts of the unit located up to 2 m above rail level or above passageways, working surfaces or tow hooks which are liable to cause accidents, shall be fitted with protective devices as described in clause 1.3 of UIC 535-2:2006

**18. Label holders and attachment devices for rear end signal**

All units shall be equipped with a label holder in accordance with clause 1 of UIC 575:1995 and at both ends with attachment devices as set out in point 4.2.6.3.

 <b>OTIF</b>	<b>ROLLING STOCK</b> <b>FREIGHT WAGONS</b>		<b>UTP WAG 2015</b> <b>Page 76 of 133</b>	
	Status: <b>PROPOSAL</b>	Version: 04	TECH-16014-CTE9-5.1b	Original: EN

### Appendix D: Standards or normative documents referred to in this UTP/TSI

UTP/TSI		Standard	
Characteristics to be assessed		References to mandatory Standard	Clauses
<b>Structure and mechanical part</b>	<b>4.2.2</b>		
Strength of unit	4.2.2.2	EN12663-2:2010	5
		EN 15877-1:2012	4.5.13
	6.2.2.1	EN12663-2:2010	6, 7
<b>Vehicle track interaction and gauging</b>	<b>4.2.3</b>		
Gauging	4.2.3.1	EN 15273-2:2009	all
Compatibility with load carrying capacity of lines	4.2.3.2	EN 15528:2008	6.1, 6.2
Axle bearing condition monitoring	4.2.3.4	EN 15437-1:2009	5.1, 5.2
Safety against derailment running on twisted track	4.2.3.5.1	-	-
	6.2.2.2	EN 14363:2005	4.1
		EN 15839:2012	4.2
Running dynamic behaviour	4.2.3.5.2	EN 14363:2005	5
	6.2.2.3	EN 14363:2005	5
		EN 15687:2010	5.3.2.2
		EN 15827:2011	9.3
	6.1.2.1	Content of prEN 16235 included in Appendix B of this UTP(The TSI refers to ERA technical document ERA/TD/2013/01/INT version 1.0 of 11.02.2013, of which the contents are identical to Appendix B)	all
Running gear	4.2.3.6	-	-
	6.1.2. 1	EN 13749:2011	6.2
		Content of prEN 16235 included in Appendix B of this UTP (The TSI refers to ERA technical document ERA/TD/2013/01/INT version 1.0 of 11.02.2013, of which the contents are identical to Appendix B)	all
Structural design of bogie frame	4.2.3.6.1	EN 13749:2011	6.2
	6.1.2. 1	EN 13749:2011	6.2
Characteristics of wheelsets	4.2.3.6.2	-	-
	6.1.2. 2	EN 13260:2009+A1:2010	3.2.1
Characteristics of wheels	4.2.3.6.3	-	-
	6.1.2.3	EN 13979-1:2003+A1:2009 +A2:2011	7, 6.2
Characteristics of axles	4.2.3.6.4	-	-
	6.1.2. 4	EN 13103:2009+A2:2012	4, 5, 6, 7
Axle boxes / bearings	4.2.3.6.5	-	-
	6.2.2.4	EN 12082:2007+A1:2010	6
	4.2.3.6.7	-	-
Running gear for manual change of wheelsets	6.2.2.5	UIC 430-1:2012	Ann. B, H
		UIC 430-3:1995	Ann. 7
<b>Brake</b>	<b>4.2.4</b>		

 <b>OTIF</b>	<b>ROLLING STOCK</b> <b>FREIGHT WAGONS</b>		<b>UTP WAG 2015</b> <b>Page 77 of 133</b>	
	Status: <b>PROPOSAL</b>	Version: 04	TECH-16014-CTE9-5.1b	Original: EN

<b>UTP/TSI</b>		<b>Standard</b>	
<b>Characteristics to be assessed</b>		<b>References to mandatory Standard</b>	<b>Clauses</b>
In-service brake	4.2.4.3.2.1	EN 14531-6:2009	all
		UIC 544-1:2013	all
Parking brake	4.2.4.3.2.2	EN 14531-6:2009	6
		EN 15877-1:2012	4.5.25
<u>Friction elements for wheel tread brakes</u>	<del>4.2.34.63.35</del>	-	-
	<u>6.1.2.5</u>	<u>ERA technical document ERA/TD/2013-02/INT version 2.0 of XX.XX.2014</u>	<u>All</u>
<b>Environmental conditions</b>	<b>4.2.5</b>		
Environmental conditions	4.2.5	EN 50125-1:1999	4.7
	6.2.2.7	-	-
<b>System protection</b>	<b>4.2.6</b>		
Fire safety - barriers	4.2.6.1.2.1	-	-
	6.2.2.8.1	EN 1363-1:1999	all
Fire safety - materials	4.2.6.1.2.2	-	-
	6.2.2.8.2	ISO 5658-2:2006/Am1:2011 EN 13501-1:2007+A1:2009	all all
Fire safety - cables	6.2.2.8.3	EN 50355:2003	all
		EN 50343:2003	all
Fire safety	6.2.2.8.4	TS 45545-7:2009	all
Protection against el. hazard – indirect contact	4.2.6.2.2.1	EN 50153:2002	6.4
Protection against el. hazard – direct contact	4.2.6.2.2.2	EN 50153:2002	5
Attachment devices for rear-end signals	4.2.6.3	Appendix J (The TSI refers to ERA technical document ERA/TD/2012-04/INT version 1.2 of 18.01.2013)	Chapter 1

 <b>OTIF</b>	<b>ROLLING STOCK</b> <b>FREIGHT WAGONS</b>		<b>UTP WAG 2015</b> <b>Page 78 of 133</b>	
	Status: <b>PROPOSAL</b>	Version: 04	TECH-16014-CTE9-5.1b	Original: EN

Additional optional conditions for units	App. C	Standard / UIC leaflet	
Manual coupling system	C.1	EN 15566:2009+A1:2010	all
		EN 15551:2009+A1:2010	6.2, 6.2:3.21
		Appendices K and L (The TSI refers to ERA technical document ERA/TD/2012-04/INT version 1.2 of 18.01.2013)	Chapters 2 and 3
		EN15877-1:2012	Figure 75
UIC footsteps and handrails	C.2	Appendix M (The TSI refers to ERA technical document ERA/TD/2012-04/INT version 1.2 of 18.01.2013)	Chapter 4
Ability to be hump shunted	C.3	EN 12663-2:2010	5, 8
Marking of units (RIV)	C.5	EN15877-1:2012	all
Tests concerning long. compressive forces	C.8	EN 15839:2012	all
UIC brake	C.9	EN 15355:2008+A1:2010	all
		EN 15611:2008+A1:2010	all
		UIC 540:2006	all
		EN 14531-1:2005	5.11
		EN 15624:2008+A1:2010	all
		EN 15625:2008+A1:2010	all
		EN 286-3:1994	all
		EN 286-4:1994	all
		EN 15807:2011	all
		EN 14601:2005+A1:2010	all
		UIC 541-1:2010	Ann. E
		UIC leaflet 542:2010	all
		<u>UIC 541-4:2010</u>	<u>all</u>
		Appendix N (The TSI refers to ERA technical document ERA/TD/2012-05/INT version 1.0 of 04.06.2012)	all
EN 15595:2009+A1:2011	all		
Welding	C.12	EN 15085-1-5:2007	all

 <b>OTIF</b>	<b>ROLLING STOCK FREIGHT WAGONS</b>			<b>UTP WAG 2015</b> Page 79 of 133
	Status: <b>PROPOSAL</b>	Version: 04	TECH-16014-CTE9-5.1b	Original: EN

Specific product properties concerning the wheel	C.15	EN 13262:2004 +A1:2008+A2:2011	all
		EN 13979-1:2003 +A1:2009+A2:2011	all
Tow hooks	C.16	UIC 535-2:2006	1.4
Protective devices on protruding parts	C.17	UIC 535-2:2006	1.3
Lable holders and attachment devices for rear end signal	C.18	UIC 575:1995	1

 <b>OTIF</b>	<b>ROLLING STOCK</b> <b>FREIGHT WAGONS</b>		<b>UTP WAG 2015</b> <b>Page 80 of 133</b>	
	Status: <b>PROPOSAL</b>	Version: 04	TECH-16014-CTE9-5.1b	Original: EN

## Appendix E: Rear-end signal

### 1. Lamps

The colour of tail lamps shall be in accordance with clause 5.5.3 of EN 15153-1:2013~~0~~.

The lamp shall display a luminous area of at least 170 mm diameter. The reflector system shall be designed to display a lighting strength of at least 15 candela of red light along the axis of the lighting surface for an angle of opening of 15° horizontally and 5° vertically. The intensity must be at least 7.5 candela of red light.

The lamp shall be suitable to be attached to units complying with the attachment devices and the clearance set out in point 4.2.6.3. The lamp shall be equipped with:

- a switch (on/off)
- a warning light which indicates the battery status.

### 2. Reflective plates

The reflective plates shall be suitable to be attached to units complying with the attachment devices and the clearance set out in point 4.2.6.3. The reflective section of the plates shall be at least 150 by at least 200 mm as illustrated in figure E.1. The side triangles shall be white, the top and the bottom triangles shall be red. The plate shall be retro-reflective in accordance with EN 12899-1:2007 Class Ref. 2.

*Fig. E.1*

*Reflective plate*

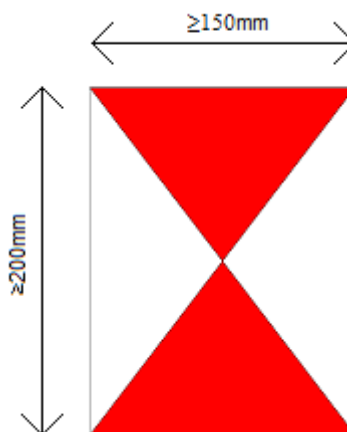



 <b>OTIF</b>	<b>ROLLING STOCK</b> <b>FREIGHT WAGONS</b>			<b>UTP WAG 2015</b> <b>Page 81 of 133</b>
	Status: <b>PROPOSAL</b>	Version: 04	TECH-16014-CTE9-5.1b	Original: EN

## Appendix F: Assessment assigned to the production phases

*Table F.1*

### *Assessment assigned to the production phases*

Characteristics to be assessed, as specified in section 4.2		Design and development phase		Production phase	Particular assessment procedure
		Design review	Type Test	Routine Test	
Element of the Rolling Stock sub-system	Point				Point
<b>Structure and mechanical part</b>	<b>4.2.2</b>				
End coupling	4.2.2.1.1	X	n.a.	n.a.	-
Inner coupling	4.2.2.1.2	X	n.a.	n.a.	-
Strength of unit	4.2.2.2	X	X	n.a.	6.2.2.1
Integrity of the unit	4.2.2.3	X	n.a.	n.a.	-
<b>Vehicle track interaction and gauging</b>	<b>4.2.3</b>				
Gauging	4.2.3.1	X	n.a.	n.a.	-
Compatibility with load carrying capacity of lines	4.2.3.2	X	X	n.a.	-
Compatibility with train detection systems	4.2.3.3	X	X	n.a.	-
Axle bearing condition monitoring	4.2.3.4	X	X	n.a.	-
Safety against derailment running on twisted track	4.2.3.5.1	X	X	n.a.	6.2.2.2
Running dynamic behaviour	4.2.3.5.2	X	X	n.a.	6.1.2.1 / 6.2.2.3
Structural design of bogie frame	4.2.3.6.1	X	X	n.a.	6.1.2.1
Characteristics of wheelsets	4.2.3.6.2	X	X	X	6.1.2.2
Characteristics of wheels	4.2.3.6.3	X	X	X	6.1.2.3
Characteristics of axles	4.2.3.6.4	X	X	X	6.1.2.4
Axle boxes / bearings	4.2.3.6.5	X	X	X	6.2.2.4
Variable gauge wheelsets	4.2.3.6.6	open	open	open	open
Running gear for manual change of wheelsets	4.2.3.6.7	X	X	n.a.	6.2.2.5
<b>Brake</b>	<b>4.2.4</b>				
Safety requirements	4.2.4.2	X	n.a.	n.a.	-
Functional and technical requirements	4.2.4.3	X	X	n.a.	-
In-service brake	4.2.4.3.2.1	X	X	n.a.	-
Parking brake	4.2.4.3.2.2	X	n.a.	n.a.	-
Thermal capacity	4.2.4.3.3	X	X	n.a.	6.2.2.6
Wheel slide protection (WSP)	4.2.4.3.4	X	X	n.a.	-
<b>Friction elements for wheel tread brakes</b>	<b>4.2.4.3.5</b>	<b>X</b>	<b>X</b>	<b>X</b>	<b>6:1:2:5</b>
<b>Environmental conditions</b>	<b>4.2.5</b>				
Environmental conditions	4.2.5	X	n.a. /X <sup>(1)</sup>	n.a.	6.2.2.7
<sup>(1)</sup> Type test if and as defined by the applicant					
<b>System protection</b>	<b>4.2.6</b>				
Fire safety	4.2.6.1	X	X	n.a.	6.2.2.8
Protection against electric hazard	4.2.6.2	X	X	n.a.	-
Attachment devices for rear end signal	4.2.6.3	X	X	n.a.	-

 <b>OTIF</b>	<b>ROLLING STOCK FREIGHT WAGONS</b>			<b>UTP WAG 2015</b> Page 82 of 133
Status: <b>PROPOSAL</b>	Version: 04	TECH-16014-CTE9-5.1b	Original: EN	Date: 1.4.2016

**Appendix G: list of fully approved composite brake blocks for international transport**

This Appendix is the “List of fully approved composite brake blocks for international transport”, reference: ERA/TD/2009-02/INT version 14.0 of 20 January 2015.

This Appendix is published on the ERA website (<http://www.era.europa.eu>).

 <b>OTIF</b>	<b>ROLLING STOCK</b> <b>FREIGHT WAGONS</b>		<b>UTP WAG 2015</b> <b>Page 83 of 133</b>	
	Status: <b>PROPOSAL</b>	Version: 04	TECH-16014-CTE9-5.1b	Original: EN

## Appendix H: Interfaces with control-command and signalling systems

Axle distances (these values are used to define the distance between two consecutive axles in a train):

- The greatest distance between two consecutive axles shall not exceed 20,000 mm.
- The shortest distance between two consecutive axles [in mm] shall not be less than 7.2 times the maximum operational speed in km/h.
- The distance between the end axles of the wagon shall not be less than 3,000 mm
- the distance between the end of the vehicle (e.g. buffer) and the first axle of the unit shall not exceed 4,200 mm.

Impedance between wheels:

- The electrical resistance between the running surfaces of the opposite wheels of a wheelset shall not exceed 0.05 Ohm, measured at a voltage of between 1.8 VDC and 2.0 VDC (open circuit).

Wheel Geometry:

- Minimum wheel rim width shall be as specified in section 4.2.3.6.3 “Characteristics of wheels” of this UTP.
- The wheel diameter shall not be less than

<sup>(54)</sup>

### 3.1.2.1. Maximum axle distance

*Harmonised parameter:*

- The distance  $a_i$  (Fig. 1) does not exceed 20 000 mm.

### 3.1.2.2. Minimum axle distance (1)

*Harmonised parameter:*

- For the maximum speed  $v$  lower or equal to 350 km/h: The distance  $a_i$  (Fig.1) is  $a_i \geq v \times 7,2$  (where  $v$  is in km/h and distance  $a_i$  is in mm)

### 3.1.2.4. Minimum axle distance (3)

*Harmonised parameter:*

- The distance between first and last axle  $L - (b_1 + b_2)$  (Fig.1) is at least 3 000 mm

### 3.1.2.6. Distances between end of train and first axle on other lines

*Harmonised parameter:*

- The distance  $b_x$  (Fig. 1) does not exceed 4 200 mm.

### 3.1.9. Impedance between wheels

*Harmonised parameter:*

- The electrical resistance between the running surfaces of the opposite wheels of a wheelset does not exceed 0.05 Ohm, measured by a voltage between 1.8 VDC and 2.0 VDC (open circuit).

### 3.1.3.1. Minimum wheel rim width

*Harmonised parameter:*

- The dimension  $B_R$  (Fig. 2) is at least 133 mm.

### 3.1.3.2. Minimum wheel diameter

<sup>54</sup> The corresponding EU requirements are set out in Annex A, index 77 of Decision 2012/88/EU (CCS TSI), which refers to ERA document ERA/ERTMS/033281. Only the specifications relevant to freight wagons are listed.

 <b>OTIF</b>	<b>ROLLING STOCK</b> <b>FREIGHT WAGONS</b>		<b>UTP WAG 2015</b> <b>Page 84 of 133</b>	
	Status: <b>PROPOSAL</b>	Version: 04	TECH-16014-CTE9-5.1b	Original: EN

330 mm for wagons with a maximum operational speed of 100 km/h or less. For wagons with a maximum operational speed of more than 100 km/h, the wheel diameter [mm] shall not be less than 150 mm + 1.8 times the maximum operational speed in km/h.

- Minimum flange thickness shall be as specified in section 4.2.3.6.3 “Characteristics of wheels” of this UTP
- Flange height shall be as specified in section 4.2.3.6.3 “Characteristics of wheels” of this UTP

The metal-free space around wheels:

- Only wheels and their parts (gearboxes, brake parts, etc.) or non-ferromagnetic and non-inductive components shall be mounted in the area defined in figure 3.

*Harmonised parameter:*

- *For the maximum speed  $v$ , the dimension  $D$  (Fig. 2) is at least*

$v$ [km/h]	$D$ [mm]
$v \leq 100$	330
$100 < v \leq 250$	$150 + 1.8 \times v$

*3.1.3.3. Minimum flange thickness*

*Harmonised parameter:*

- *The dimension  $S_d$  (Fig. 2) is at least:*
  1. *27.5 mm if the dimension  $D$  (Fig. 2) does not exceed 840 mm*
  2. *20.0 mm if the dimension  $D$  (Fig. 2) is more than 840 mm*

*3.1.3.4. Flange height*

*Harmonised parameter:*

- *The range of the dimension  $S_h$  (Fig. 2) is 27.5 — 36 mm*

*3.1.3.5. Metal and inductive components-free space between wheels*

*Harmonised parameter:*

- *For freight wagons: only wheels and their parts (gearboxes, brake parts, sanding tube) or non-ferromagnetic and non-inductive components are mounted in the sensitive area of Fig. 3.*

 <b>OTIF</b>	<b>ROLLING STOCK</b> <b>FREIGHT WAGONS</b>		<b>UTP WAG 2015</b> Page 85 of 133	
	Status: <b>PROPOSAL</b>	Version: 04	TECH-16014-CTE9-5.1b	Original: EN

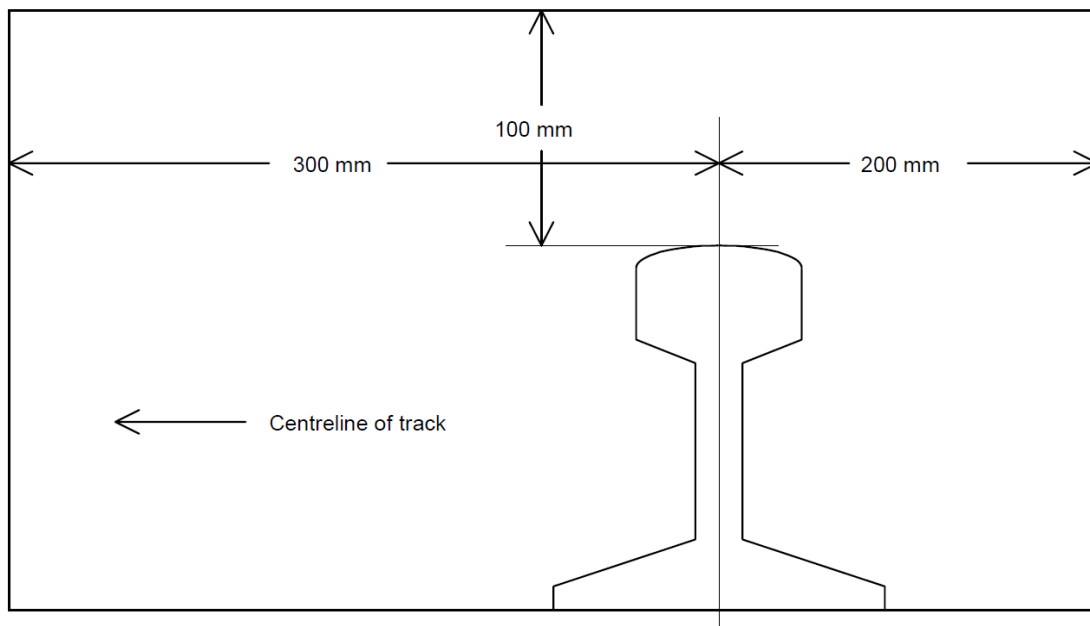

Figure 3

The characteristics of the wheel material regarding magnetic fields:

- The wheels shall have ferromagnetic characteristics ( $\mu_r > 300$ ) and shall be electrically conductive.

Use of composite brake blocks

- The vehicles shall use brake blocks assessed for the effects on the contact resistance between wheel and rail. Brake blocks listed in the list referred to in Appendix G of this UTP are deemed to be in conformity with this requirement.

Load and mass:

- The minimum axle load in all load conditions shall be 3.5t for wagons with more than 4 axles and brake blocks; 4t for wagons with 4 axles and brake blocks, 5t for other wagons.

The metal-mass of the vehicle:

- The metal-mass of a wagon is an open point for the interface with loop detection systems.

### 3.1.3.6. Wheel material

*Harmonised parameter:*

- The wheels have ferromagnetic characteristics ( $\mu_r > 300$ ) and are electrically conducting.

### 3.1.6. Use of composite brake blocks

*Harmonised parameter:*

- The vehicles use brake blocks assessed for the effects on the contact resistance between wheel and rail.

### 3.1.7.1. Axle load

*Harmonised parameter:*

*The axle load is*

1. at least 5 t generally for vehicles with 2 axles and more,
2. at least 4 t for vehicles with 4 axles and brake blocks,
3. at least 3,5 t for vehicles with more than 4 axles and brake blocks.

### 3.1.7.2. Vehicle metal mass

*Harmonised parameter:*

- The metal-mass of a vehicle is: [open point].

 <b>OTIF</b>	<b>ROLLING STOCK FREIGHT WAGONS</b>			<b>UTP WAG 2015 Page 86 of 133</b>
Status: <b>PROPOSAL</b>	Version: 04	TECH-16014-CTE9-5.1b	Original: EN	Date: 1.4.2016

## Appendix I: Safety management provisions

- The rail transport undertaking operating the train must supply the driver with all the necessary information and documentation required to carry out his duties. This information must take into account the necessary elements for operation in normal, degraded and emergency situations for the routes to be worked over and the rolling stock used on those routes.

(<sup>55</sup>) (4.2.1.2.) *The railway undertaking operating the train must supply the driver with all the necessary information and documentation required to carry out his duties.*

*This information must take into account the necessary elements for operation in normal, degraded and emergency situations for the routes to be worked over and the rolling stock used on those routes.*
- The rail transport undertaking operating the train must supply all members of his staff (whether on train or otherwise) who undertake safety-critical tasks with all the rolling stock specific information it deems appropriate to such tasks. Such information shall be applicable in both normal and degraded operation.

(4.2.1.3.) *The railway undertaking must provide all members of his staff (whether on train or otherwise) who undertake safety-critical tasks involving a direct interface with the staff, equipment or systems of the infrastructure manager with the rules, procedures, rolling stock and route specific information it deems appropriate to such tasks. Such information shall be applicable in both normal and degraded operation.*
- A process must be defined to ensure the acquisition and retention of vehicle knowledge by the train crew.

~~(4.6.3.2.3.2.) The railway undertaking must define the process for the acquisition and retention of traction and rolling stock knowledge by its train crew.~~
- The rail transport undertaking operating the train must provide the required means<sup>56</sup> of indicating the rear of a train in compliance with the rules of the network on which the vehicle is operated. The rear end signal must only be exhibited on the rear of the last vehicle of the train.

(4.2.2.1.3.) *The railway undertaking must provide the required means of indicating the rear of a train. The rear end signal must only be exhibited on the rear of the last vehicle of the train. It must be displayed as shown below.*
- Where a freight wagon is used as the front-end of a train, the rail transport undertaking operating the train must provide the means of indicating the front-end of a train in compliance with the rules of the network on which the train is operated.

(4.2.2.1.2.) *The railway undertaking must ensure that an approaching train is clearly visible and recognisable as such, by the presence and layout of its lit white front-end lights.*

*The forward facing front-end of the leading vehicle of a train must be fitted with three lights in an isosceles triangle, as shown below.*
- The rail transport undertaking operating the train must make sure that freight vehicles are safely and securely loaded and remain so throughout the journey.

(4.2.2.4.1.) *The railway undertaking must make sure that freight vehicles are safely and securely loaded and remain so throughout the journey.*
- Train composition shall be the responsibility

(4.2.2.5.) *The railway undertaking must define*

<sup>55</sup> The corresponding EU requirements are set out in Decision 2012/757/EC (OPE TSI) as last amended by Commission Regulation (EU) 2015/995 of 8<sup>th</sup> of June 2015

<sup>56</sup> "required means" are lamps and/or plates as specified in Appendix E

 <b>OTIF</b>	<b>ROLLING STOCK FREIGHT WAGONS</b>			<b>UTP WAG 2015 Page 87 of 133</b>
Status: <b>PROPOSAL</b>	Version: 04	TECH-16014-CTE9-5.1b	Original: EN	Date: 1.4.2016

of the rail transport undertaking. Rules and procedures shall be defined which must be followed by the staff so as to ensure that the train is in compliance with the allocated path.

- Train composition requirements must take into account the following elements:

a) the vehicles

— all vehicles in the train must be in compliance with all the requirements applicable on the routes over which the train will run;

— all vehicles on the train must be fit to run at the maximum speed at which the train is scheduled to run;

— all vehicles on the train must be currently within their specified maintenance interval and remain so for the duration (in terms of both time and distance) of the journey being undertaken;

b) the train

— the combination of vehicles forming a train must comply with the technical constraints of the route concerned and be within the maximum length permissible for forwarding and receiving terminals.

— the railway undertaking is responsible for ensuring that the train is technically fit for the journey to be undertaken and remains so throughout the journey

c) the weight and axle load

— the weight of the train must be within the maximum permissible for the section of route, the strength of the couplings, the traction power and other relevant characteristics of the train. Axle load limitations must be respected.

d) the maximum speed of the train

— the maximum speed at which the train can run must take into account any restrictions on the route(s) concerned, braking performance, axle load and vehicle type.

e) the kinematic envelope

— the kinematic gauge of each vehicle (inclusive of any load) in the train must be within the maximum permissible for the section of route.

*the rules and procedures to be followed by his staff so as to ensure that the train is in compliance with the allocated path.*

~~(4.2.2.5.)~~ *Train composition requirements must take into account the following elements:*

*(a) the vehicles*

*— all vehicles in the train must be in compliance with all the requirements applicable on the routes over which the train will run;*

*— all vehicles on the train must be fit to run at the maximum speed at which the train is scheduled to run;*

*(b) — all vehicles on the train must be currently within their specified maintenance interval and will remain so for the duration (in terms of both time and distance) of the journey being undertaken;*

*(bc) the train*

*— the combination of vehicles forming a train must comply with the technical constraints of the route concerned and be within the maximum length permissible for forwarding and receiving terminals.*

*(d) — the railway undertaking is responsible for ensuring that the train is technically fit for the journey to be undertaken and remains so throughout the journey*

*(ee) the weight and axle load*

*(f) — the weight of the train must be within the maximum permissible for the section of route, the strength of the couplings, the traction power and other relevant characteristics of the train. Axle load limitations must be respected.*

*(dg) the maximum speed of the train*

*— the maximum speed at which the train can run must take into account any restrictions on the route(s) concerned, braking performance, axle load and vehicle type.*

*(eh) the kinematic envelope*

*(i) — the kinematic gauge of each vehicle (inclusive of any load) in the train must be within the maximum permissible for the section of route.*

*Additional constraints may be required or imposed due to the type of braking regime or*



 <b>OTIF</b>	<b>ROLLING STOCK FREIGHT WAGONS</b>			<b>UTP WAG 2015 Page 88 of 133</b>
Status: <b>PROPOSAL</b>	Version: 04	TECH-16014-CTE9-5.1b	Original: EN	Date: 1.4.2016

Additional constraints may be required or imposed due to the type of braking regime or traction type on a particular train

- All vehicles in a train must be connected to the continuous automatic braking system. The first and last vehicles (including any traction units) in any train must have the automatic brake operative<sup>57</sup>. The rail transport undertaking operating the train must ensure that the train meets the required braking performance.

*traction type on a particular train*

*(4.2.2.6.1.) All vehicles in a train must be connected to the continuous automatic braking system as defined in the TSI Rolling Stock*

*The first and last vehicles (including any traction units) in any train must have the automatic brake operative.*

*(4.2.2.6.2.) Braking performance and maximum speed allowed*

*(1) The infrastructure manager shall provide the railway undertaking with all relevant line characteristics for each route:*

*- signalling distances (warning, stopping) containing their inherent safety margins,*

*- gradients,*

*- maximum permitted speeds, and*

*- conditions of use of braking systems possibly affecting the infrastructure such as magnetic, regenerative and eddy-current brake.*

*(2) Additionally, the infrastructure manager may provide the following information:*

*(i) for trains able to run at a maximum speed higher than 200 km/h, deceleration profile and equivalent response time on level track;*

*(ii) for trainsets or for fixed train compositions, unable to run at a maximum speed higher than 200 km/h, deceleration (as above in (i)) or brake weight percentage;*

*(iii) for other trains (variable compositions of trains unable to run at a maximum speed higher than 200 km/h): brake weight percentage.*

*If the infrastructure manager provides the abovementioned information, it shall be made available to all RUs who intend to operate trains on its network. The braking tables already in use and accepted for the existing lines at the date of entry into force of the present regulation shall also be made available.*

*(3) The railway undertaking shall, in the planning stage, determine the braking capability of the train and corresponding maximum speed taking into account:*

<sup>57</sup> In operation / in working order / functioning.



 <b>OTIF</b>	<b>ROLLING STOCK FREIGHT WAGONS</b>			<b>UTP WAG 2015 Page 89 of 133</b>
<b>Status: PROPOSAL</b>	<b>Version: 04</b>	<b>TECH-16014-CTE9-5.1b</b>	<b>Original: EN</b>	<b>Date: 1.4.2016</b>

o the relevant line characteristics as expressed in point (1) above or, if available, the information provided by the infrastructure manager in accordance to point (2) above. If the infrastructure manager has provided the information of point (2), the railway undertaking has to express the braking capability by using the same information, and

o the rolling-stock-related margins derived from reliability and availability of the braking system. EN L 165/24 Official Journal of the European Union 30.6.2015

Furthermore, the railway undertaking shall ensure that during operation each train achieves at least the necessary braking performance. The railway undertaking shall set up and implement corresponding rules and shall manage them within its safety management system.

In particular the railway undertaking has to set up rules to be used if a train does not reach the necessary braking performance during operation. In this case, the railway undertaking must immediately inform the infrastructure manager. The infrastructure manager may take appropriate measures to reduce the impact on the overall traffic on its network. ~~The infrastructure manager must provide the railway undertaking with the actual performance required. This data shall include, if necessary, conditions of use of braking systems possibly affecting the infrastructure such as magnetic, regenerative and eddy-current brake.~~

- Processes shall be defined, which must be followed by the rail transport undertaking to ensure that all safety-related on-train equipment is in a fully functional state and that the train is safe to run. In case of modification to the characteristics of the train affecting the ability to accommodate the train in its allocated path, procedures for running in degraded mode shall be defined.
- The rail transport undertaking shall inform the infrastructure manager of any change which affects the performance of the train, or which may affect the ability to accommodate the train in its allocated path.
- Checks shall be defined which must be followed by the rail transport undertaking to ensure that any departure is undertaken safely

*(4.2.2.7.1.) The railway undertaking must define the process to ensure that all safety-related on-train equipment is in a fully functional state and that the train is safe to run.*

*The railway undertaking must inform the infrastructure manager of any modification to the characteristics of the train affecting its performance or any modification that might affect the ability to accommodate the train in its allocated path.*

*The infrastructure manager and the railway undertaking must define and keep up to date conditions and procedures for train running in degraded mode.*

*(4.2.3.3.1.) The railway undertaking must define the checks and tests to ensure that any departure is undertaken safely (e.g. doors, load, brakes).*

 <b>OTIF</b>	<b>ROLLING STOCK FREIGHT WAGONS</b>			UTP WAG 2015 Page 90 of 133
Status: <b>PROPOSAL</b>	Version: 04	TECH-16014-CTE9-5.1b	Original: EN	Date: 1.4.2016

(e.g. doors, load, brakes).

|

 <b>OTIF</b>	<b>ROLLING STOCK FREIGHT WAGONS</b>		<b>UTP WAG 2015 Page 91 of 133</b>	
	Status: <b>PROPOSAL</b>	Version: 04	TECH-16014-CTE9-5.1b	Original: EN

**Appendix J: Attachment device for rear-end signal (point 4.2.6.3)**

*This appendix is a transcription of section 1 of the ERA technical document ERA/TD/2012-04/INT version 1.3 of 2 December 2014 published on the ERA website and referred to in the WAG TSI. It appears in full width in order that the drawings remain legible.*

The dimensions and clearance of the attachment devices shall be as described in figure 1.

*Figure 1: Required dimensions and clearance for tail light brackets and access*

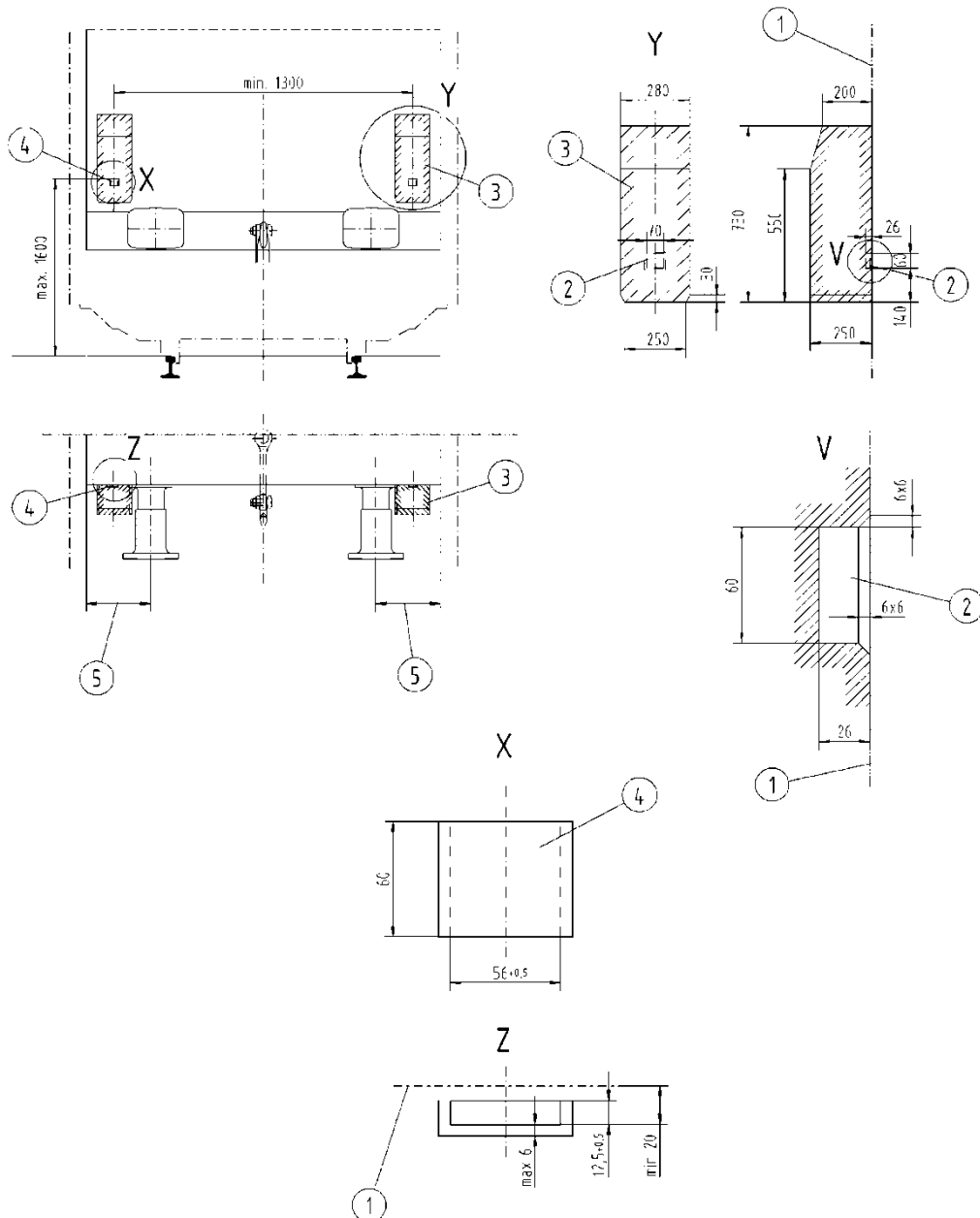

- Key:
- 1 outside of wagon end wall or bracket fixing plane
  - 2 clearance for tail light bracket
  - 3 clearance for tail light
  - 4 tail light bracket
  - 5 preferred place for tail light position

 <b>OTIF</b>	<b>ROLLING STOCK FREIGHT WAGONS</b>			<b>UTP WAG 2015 Page 92 of 133</b>
Status: <b>PROPOSAL</b>	Version: 04	TECH-16014-CTE9-5.1b	Original: EN	Date: 1.4.2016

**Appendix K: Clearance for draw hooks (Appendix C, Section 1)**

*This appendix is a transcription of section 2 of the ERA technical document ERA/TD/2012-04/INT version 1.3 of 2 December 2014 published on the ERA website and referred to in the WAG TSI. It appears in full width in order that the drawings remain legible.*

The clearance for the draw hook shall be in accordance with figure 2.

*Figure 2: Required clearance above draw hook*

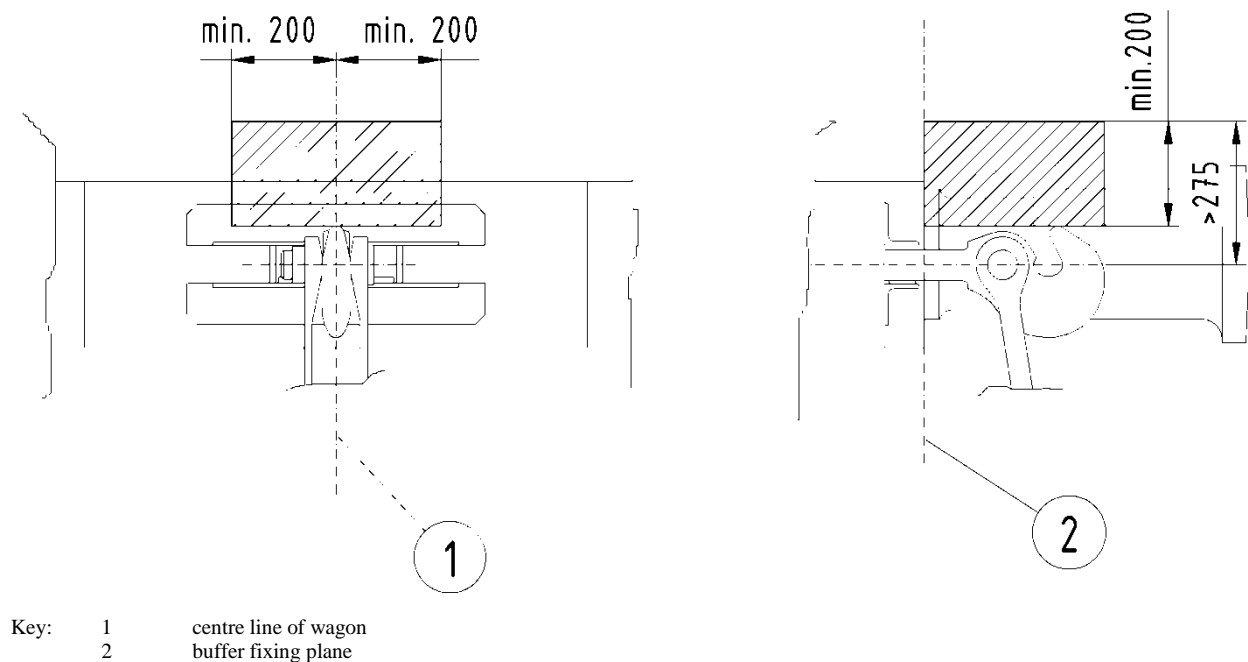

 <b>OTIF</b>	<b>ROLLING STOCK</b> <b>FREIGHT WAGONS</b>		UTP WAG 2015 Page 93 of 133
	Status: <b>PROPOSAL</b>	Version: 04	TECH-16014-CTE9-5.1b

### **Appendix L: Space for shunting staff operation (Appendix C, Section 1)**

*This appendix is a transcription of section 3 of the ERA technical document ERA/TD/2012-04/INT version 1.3 of 2 December 2014 published on the ERA website and as referred to in the WAG TSI. It appears in full width in order that the drawings remain legible.*

The space for shunting staff operation shall be in accordance with figure 3. Flexible connecting cables and flexible hoses may be inside this space. With the exception of the shunter handrails (see Appendix C, section 2 of this UTP), there shall be no devices under the buffers that hinder access to the space.

*Figure 3: Required space for shunter during coupling and uncoupling*

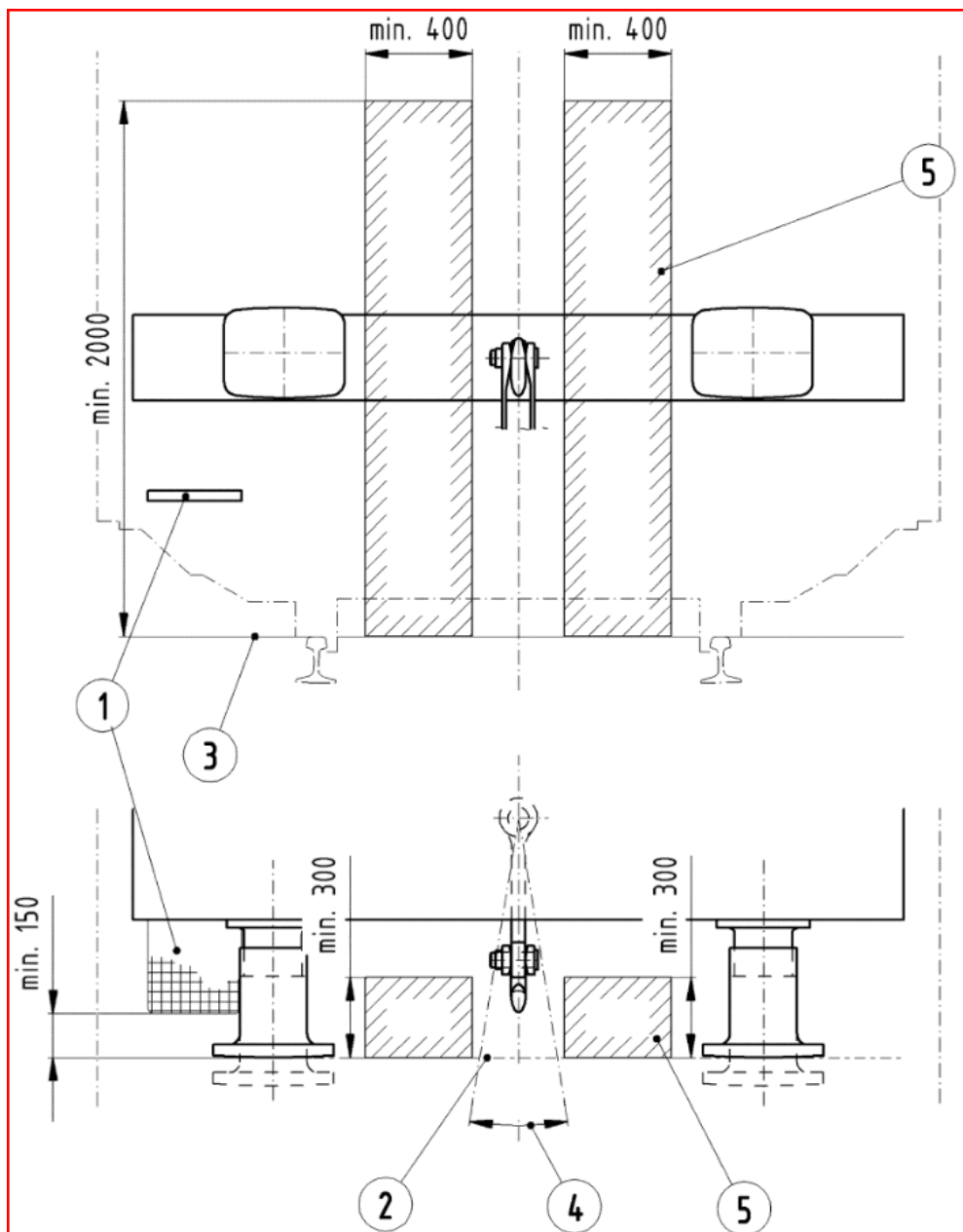

- Key:
- 1 end step
  - 2 contact plane of fully compressed buffers
  - 3 top of rail
  - 4 lateral movement of coupling at coupled units
  - 5 space for shunter

 <b>OTIF</b>	<b>ROLLING STOCK</b> <b>FREIGHT WAGONS</b>			<b>UTP WAG 2015</b> <b>Page 94 of 133</b>
	Status: <b>PROPOSAL</b>	Version: 04	TECH-16014-CTE9-5.1b	Original: EN

## **Appendix M: Footsteps and handrails (Appendix C, Section 2)**

*This appendix is a transcription of section 4 of the ERA technical document ERA/TD/2012-04/INT version 1.3 of 2 December 2014 published on the ERA website and as referred to in the WAG TSI. It appears in full width in order that the drawings remain legible.*

### **4.1 Minimum requirements for handrails**

All handrails

- shall be of round steel bar or steel pipe with a min. diameter of 20 mm and a max. diameter of 35 mm.
- shall withstand the loads, which are applied by staff,
- shall respect a clearance to the nearest obstructions of at least 120 mm.

### **4.2 Minimum requirements for footsteps**

All footsteps

- shall have sufficient space above and around in order to enable the staff to use them safely.
- shall be slip resistant
- shall withstand the loads, which are applied by the staff.

The minimum requirements concerning slip resistance deemed to be complied with if the grating in accordance with figure 4 is used or if the following requirements are fulfilled:

#### a) Skid resistance

The average value of the friction coefficient measured in three directions (lengthwise, breadthwise and diagonally) shall reach the following minimum values:

- a) in dry condition = 0,65
- b) in wet condition (water) = 0,65
- c) in oiled condition = 0,30

Friction coefficient values shall be ascertained by means of a 100 mm x 100 mm movable plate, on which a rubber pad with 80 shore hardness shall be glued. This plate shall be loaded with a weight of 75 kg. For the measurements carried out with water and oil, the grating shall be fully immersed.

#### b) Grating structure

To ensure that the gratings are sufficiently well-adapted to winter conditions, a ratio of at least 50 % of "void" area to total area shall be observed (the "void" area is the free space afforded by the grating apertures in the vertical direction). Only apertures with a minimum area of 400 mm<sup>2</sup> shall be taken into account to determine this ratio.

With regard to the ability to withstand the load the following shall be fulfilled:

Metal gratings shall withstand, without residual deformation, a horizontal compression force of at least 4 kN, exerted parallel and at right angles to the edge of the step board, and of at least 8 kN exerted diagonally in relation to the edge of the step board. Elastic deformations shall not exceed 10 mm.

### **4.3 Shunter's stand**

There shall be at least one shunter's stand consisting of one shunter's step and one handrail at each end of the unit to enable shunting staff to travel on board the unit during shunting operations. The handrails and footsteps shall be in accordance with section 4.1 and 4.2 with the following additions and exceptions:

handrail

- A clearance of 100 mm between the handrails and the nearest obstruction is permitted.

 <b>OTIF</b>	<b>ROLLING STOCK FREIGHT WAGONS</b>			<b>UTP WAG 2015 Page 95 of 133</b>
<b>Status: PROPOSAL</b>	<b>Version: 04</b>	<b>TECH-16014-CTE9-5.1b</b>	<b>Original: EN</b>	<b>Date: 1.4.2016</b>

- The handrail shall be made from steel pipe with a diameter of 30 +5/0 mm, with a minimum wall thickness of 2 mm and a minimum clearance of 230 mm.

footstep

- The shunter's steps shall be at least 150 mm from a vertical plane at the end of the fully compressed buffers (see figure 3).
- The shunter's steps and handrails shall be placed as set out in figure 5.
- The free space above the shunter's steps shall be as set out in figure 6 with the exception concerning the handrail specified in figure 5.
- The dimensions of the shunter's step shall be in accordance with figure 4. For specific operation the size of the footstep can be reduced from 350 mm width and 350 mm length to 270 mm width and 225 mm length.
- The shunter's steps shall be fixed by means, which allow removable mounting.
- The material for the shunter's steps support shall be S355J2C + N in accordance with EN 10025-2.
- Cold forming for shunter's steps support is not allowed.
- The grating shall be according to figure 4.

The shunter's stand is not required where the end of the unit is equipped with a gangway in accordance with section 4.4.

Furthermore, there shall be a handrail under each buffer (shunter's handrail) of the unit which shall be as specified in figures 7 and 8.

 <b>OTIF</b>	<b>ROLLING STOCK</b> <b>FREIGHT WAGONS</b>		UTP WAG 2015 Page 96 of 133	
	Status: <b>PROPOSAL</b>	Version: 04	TECH-16014-CTE9-5.1b	Original: EN

Figure 4: Shunter's step



- Key:
- 1 grating from welded metal
  - 2 grating from expanded metal
  - 3 buffer fixing plane

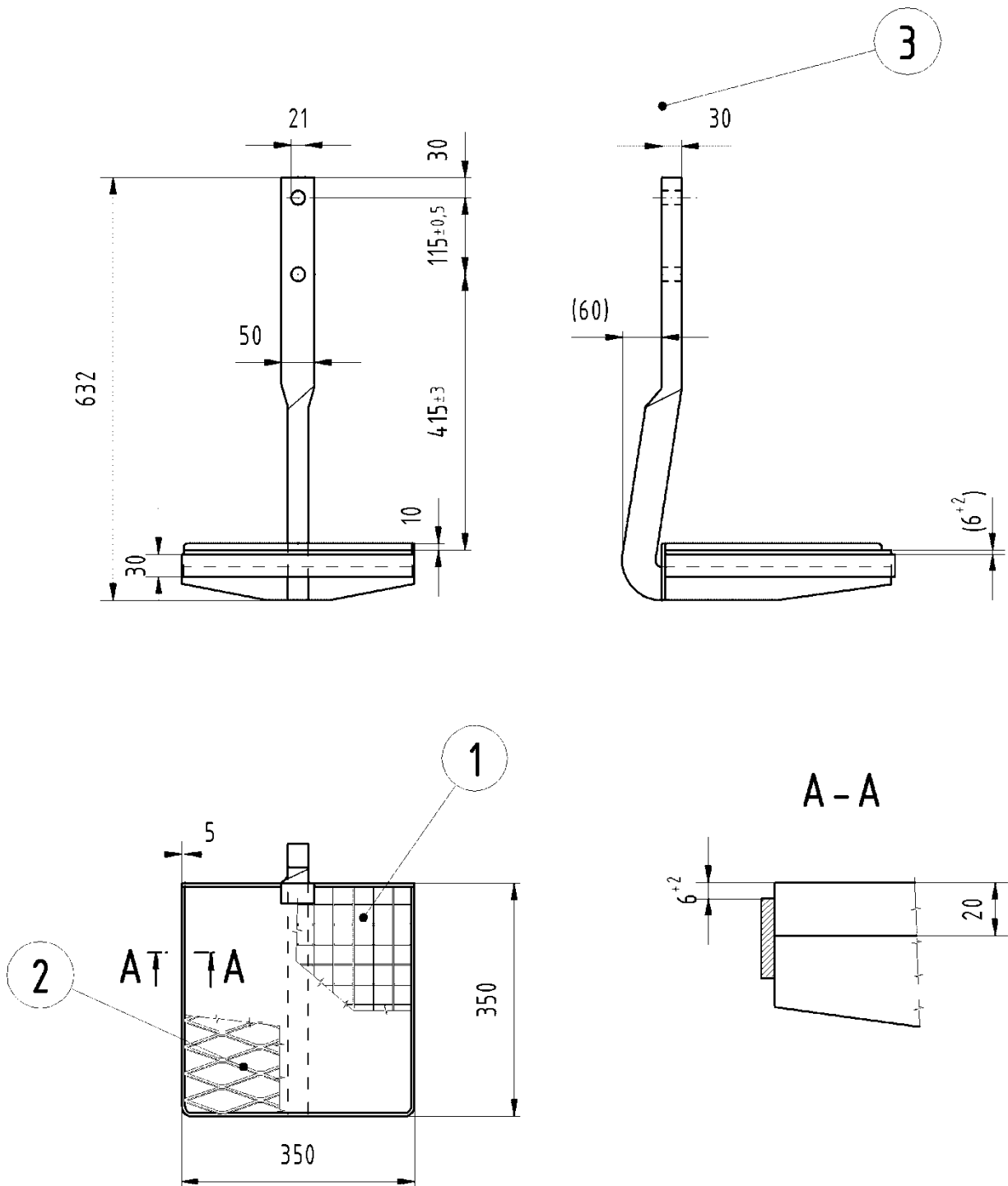

 <b>OTIF</b>	<b>ROLLING STOCK</b> <b>FREIGHT WAGONS</b>		<b>UTP WAG 2015</b> Page 97 of 133	
	Status: <b>PROPOSAL</b>	Version: 04	TECH-16014-CTE9-5.1b	Original: EN

Figure 5: Shunter's stand



- Key:
- 1 AC centre line
  - 2 buffer fixing plane
  - 3 top of rail
  - 4 reserved space as specified in Figure 5
  - 5 handrail
  - 6 step
  - 7 2<sup>nd</sup> handrail corner upright (only at wagon s with end walls)

1) In exceptional cases (e.g. particular gauges), and in order to comply with the reserved space stated in figure 6, as long as the kinematic gauge is respected, the shunter's stand can be adjusted in horizontal direction. Only if this method is not successful, a vertical adjustment of the shunter's stand could be accepted, but not more as allowed by the kinematic gauge. The vertical position shall not be less than 480 mm from coupling centre line.

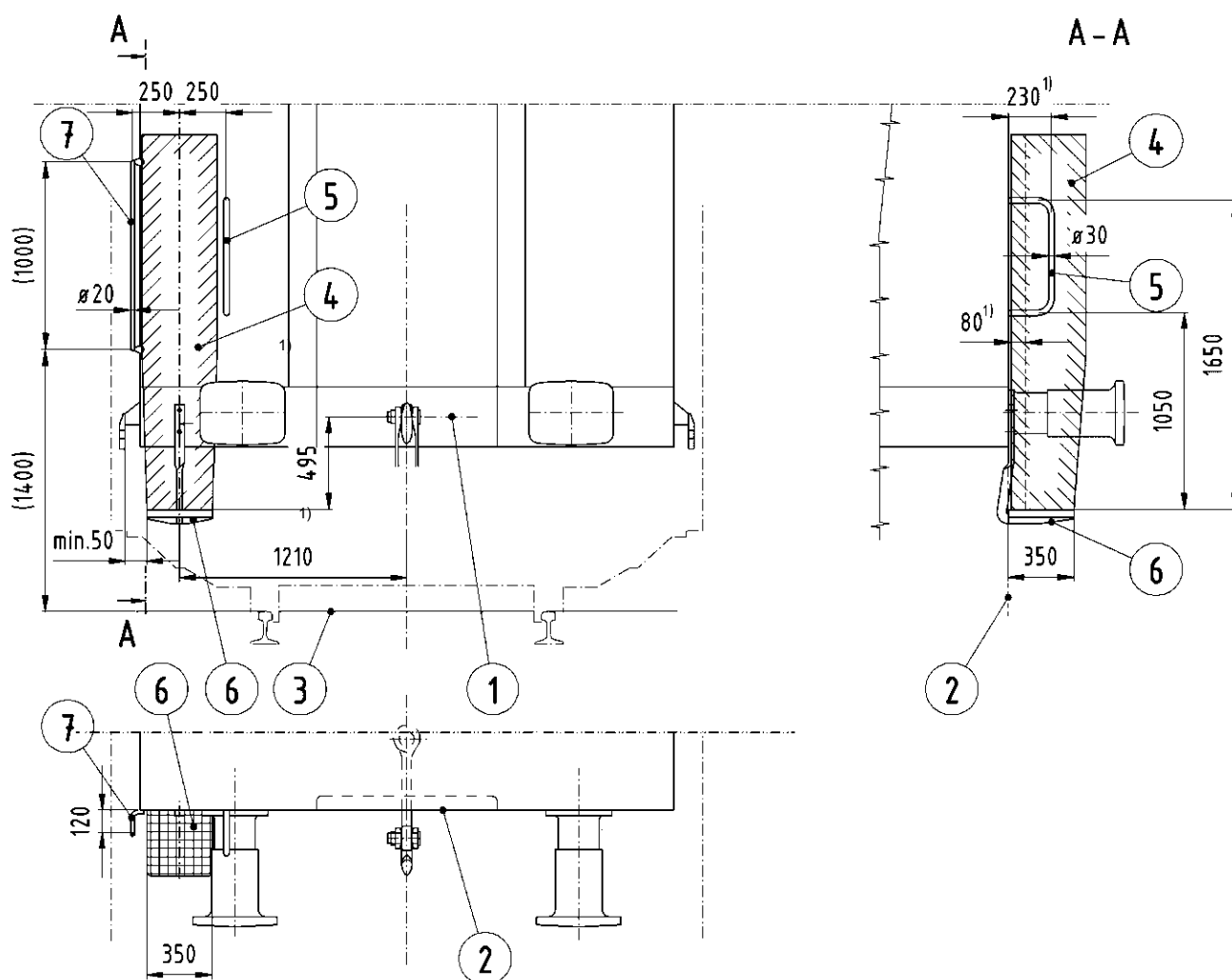
 <b>OTIF</b>	<b>ROLLING STOCK FREIGHT WAGONS</b>			UTP WAG 2015 Page 98 of 133
	Status: <b>PROPOSAL</b>	Version: 04	TECH-16014-CTE9-5.1b	Original: EN

Figure 6: Required space above left footstep



Key:

- 1 centre line of wagon
- 2 centre line of left end step
- 3 buffer fixing plane
- 4 kinematic gauge
- 5 step level

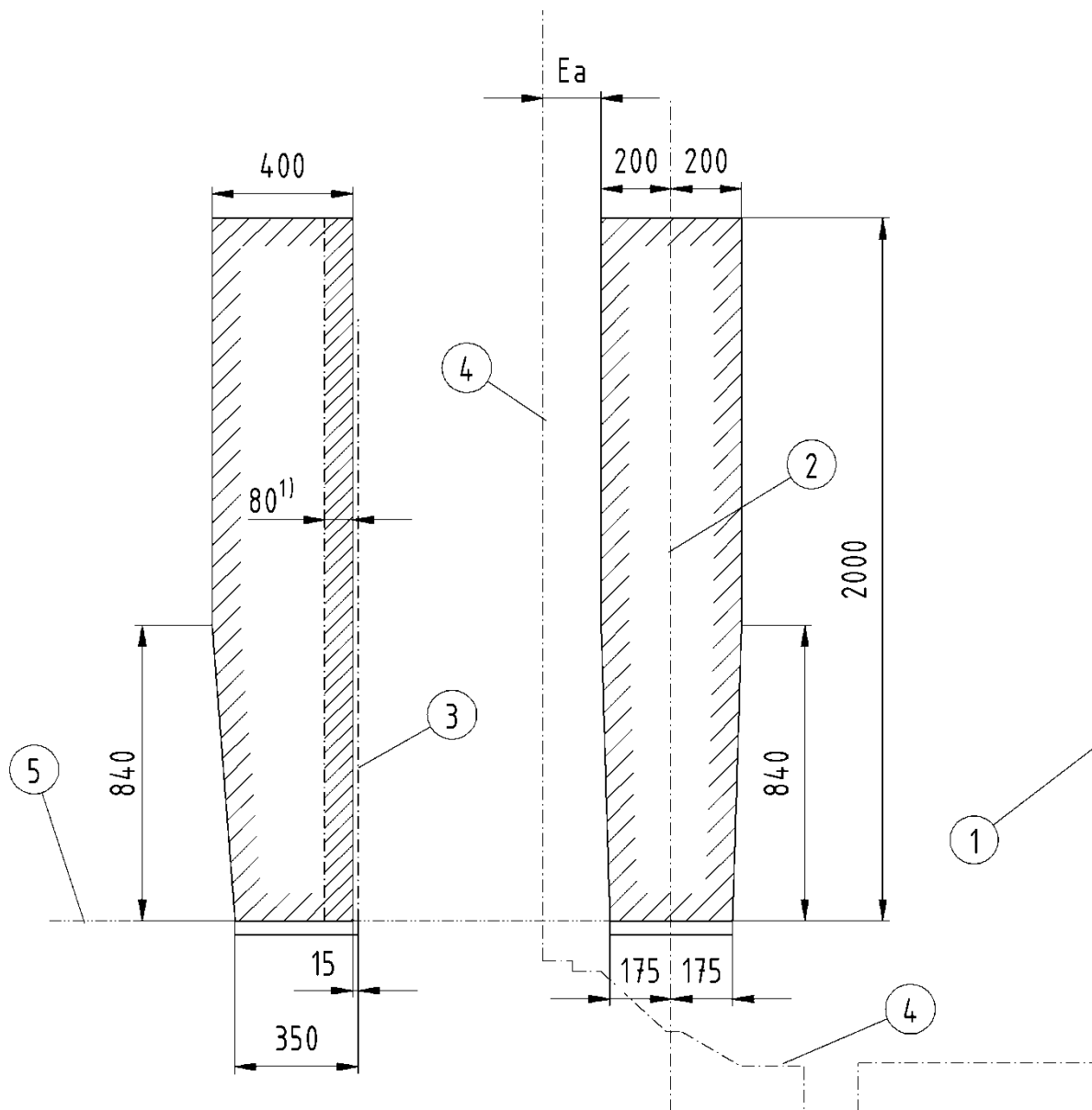
- 1) In the event of design problems, component parts such as the closing and locking devices of sliding walls may exceptionally infringe this space. These components must nonetheless be placed parallel to the end wall and have no projecting parts liable to cause injury.



 <b>OTIF</b>	<b>ROLLING STOCK</b> <b>FREIGHT WAGONS</b>		<b>UTP WAG 2015</b> Page 99 of 133	
	Status: <b>PROPOSAL</b>	Version: 04	TECH-16014-CTE9-5.1b	Original: EN

Figure 7: Positions of shunter handrails

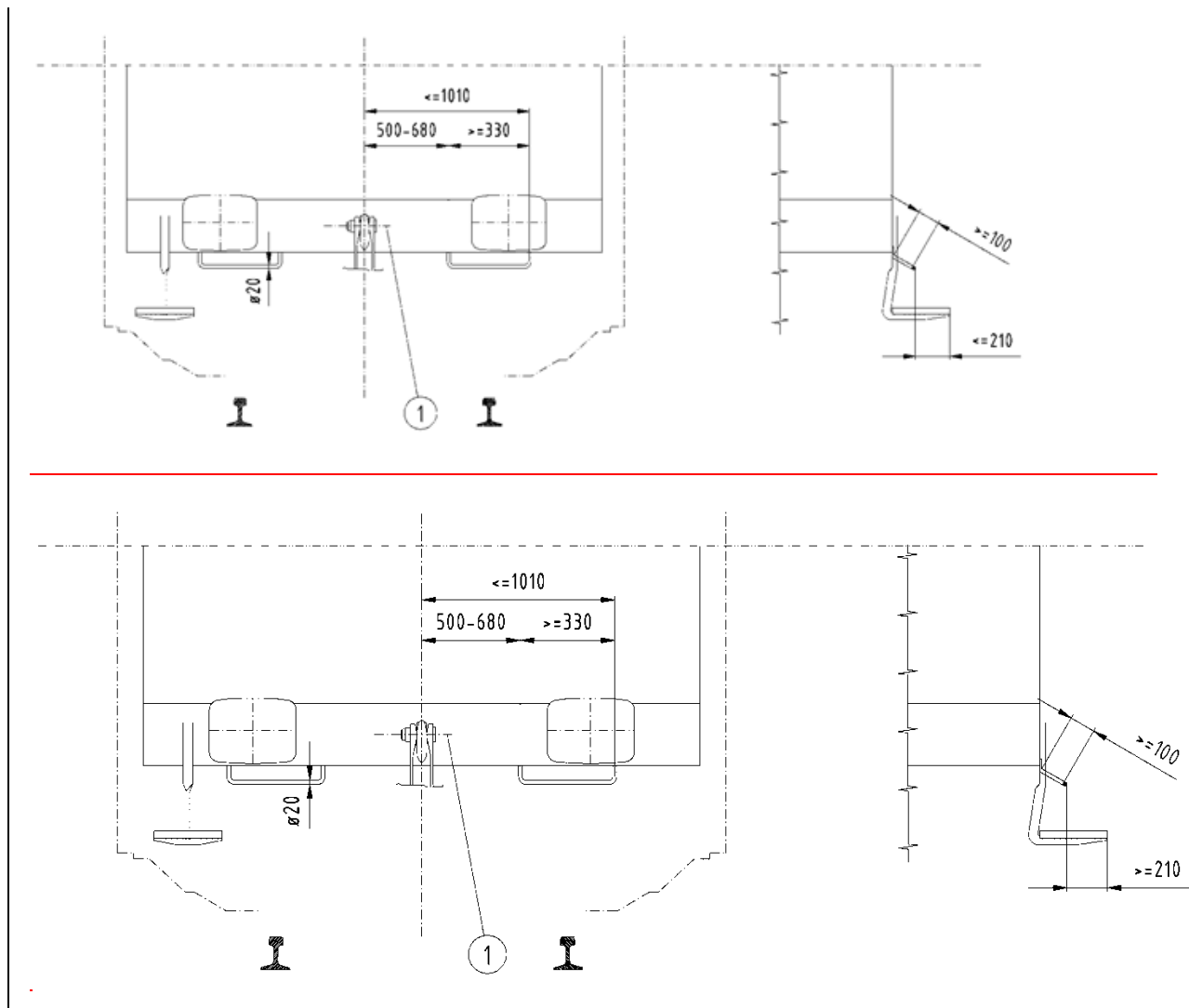

Key: 1 AC centre line

Figure 8: Position of shunter handrails by using automatic coupler

 <b>OTIF</b>	<b>ROLLING STOCK</b> <b>FREIGHT WAGONS</b>			UTP WAG 2015 Page 100 of 133
Status: <b>PROPOSAL</b>	Version: 04	TECH-16014-CTE9-5.1b	Original: EN	Date: 1.4.2016

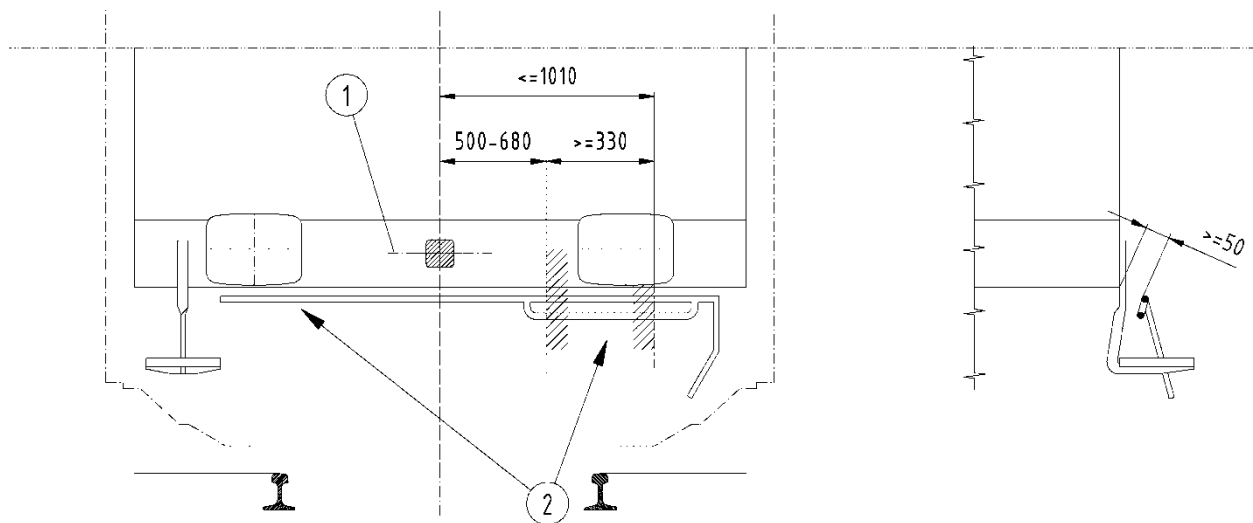

Key: 1 AC centre line  
2 area which may be used by the shunter in the case of a wagon fitted with the automatic coupler

 <b>OTIF</b>	<b>ROLLING STOCK FREIGHT WAGONS</b>			<b>UTP WAG 2015 Page 101 of 133</b>
Status: <b>PROPOSAL</b>	Version: 04	TECH-16014-CTE9-5.1b	Original: EN	Date: 1.4.2016

#### 4.4 Gangways

The design and position of the gangways shall be as specified in figure 9.

To facilitate climbing onto the gangway, the following items shall be fitted on both sides of the unit:

- Two footsteps (160 x 430 mm) long. The lower footstep shall be set at a height of 425 mm below the horizontal plane running through the centreline of the coupling.
- Vertical handrail, fitted to each corner upright.
- Vertical part of the railing shaped like a handrail.

It shall be possible for the shunting staff to remain on the upper footsteps while the vehicle is moving. To allow this, clearance shall be maintained over the upper footsteps as specified in figure 10.

The surface of the steps and of the gangway shall be designed with a non-slip surface.

The gangway shall be equipped with a gangway handrail providing a secure hand-hold for the shunting staff, even while the vehicle is moving. An intermediate rail at knee height shall be provided to prevent the shunting staff from falling off. The ends of these intermediate rails shall be fashioned in such a way as to form a guide to the footsteps.

For traffic to UK, as long as the kinematic gauge is respected, the lower footsteps can be adjusted in the horizontal direction. Only if this method is not successful, a vertical adjustment of the lower steps could be accepted, but not more than permitted by the kinematic gauge.



Status: <b>PROPOSAL</b>	Version: 04	TECH-16014-CTE9-5.1b	Original: EN	Date: 1.4.2016
-------------------------	-------------	----------------------	--------------	----------------

Figure 9: Example for gangway

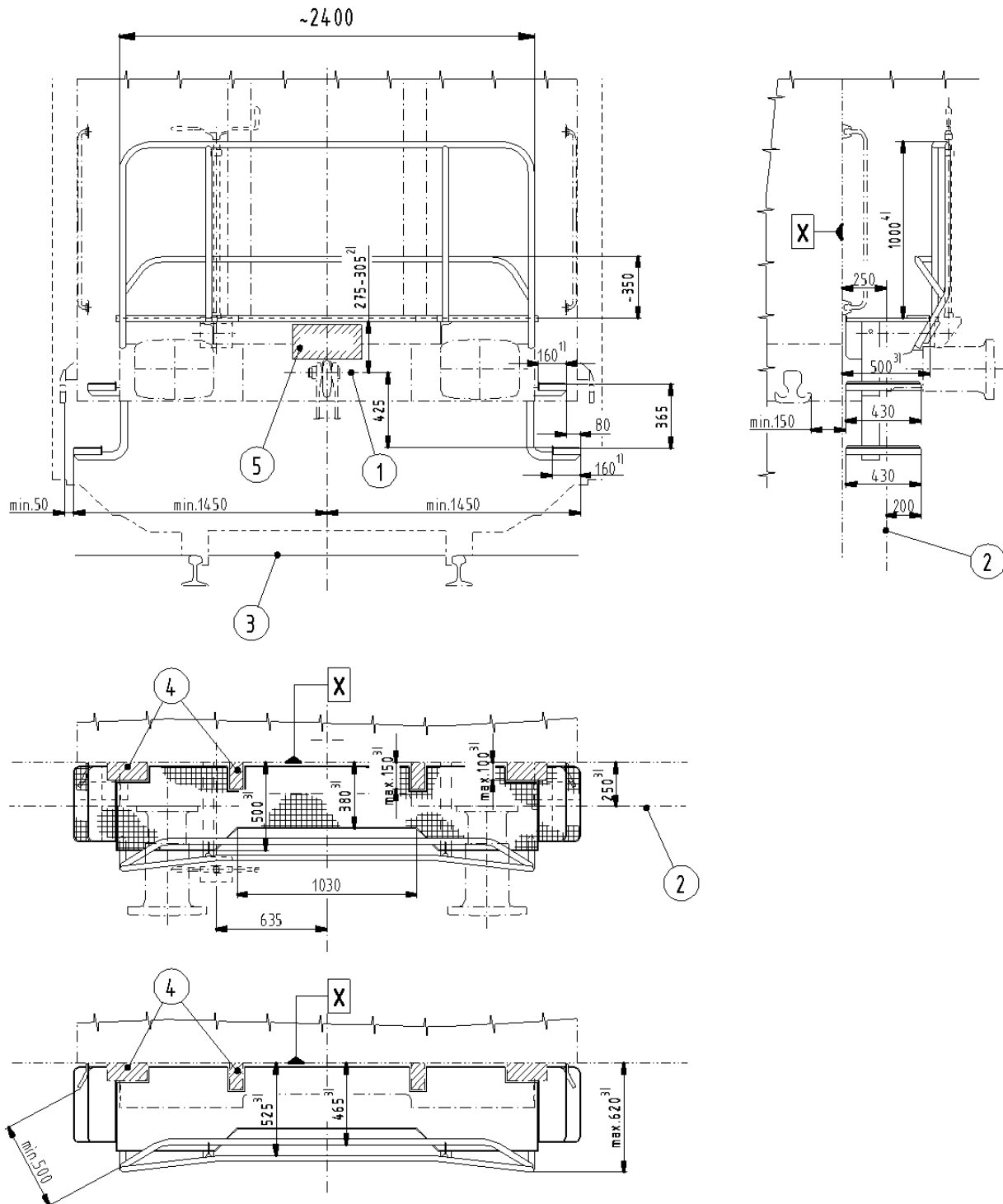

Key

- 1 coupling centre line
- 2 buffer fixing plane
- 3 top of rail
- 4 space for exceptionally infringement by components, closing and locking devices or superstructure
- 5 clearance for draw hook

- 1) step width
- 2) min. dimension for clearance of draw hook - see chapter 2, figure 2
- 3) distances from plane "X"
- 4) the height of the guard rail of 1000mm may be increased for operational reasons

 <b>OTIF</b>	<b>ROLLING STOCK FREIGHT WAGONS</b>			UTP WAG 2015 Page 103 of 133
	Status: <b>PROPOSAL</b>	Version: 04	TECH-16014-CTE9-5.1b	Original: EN

Figure 10: Required space above the top access step of the platforms and gangways



Key

- 1 centre line of wagon
- 2 kinematic gauge
- 3 step level
- 4 Transverse reduction according to EN 15273-2

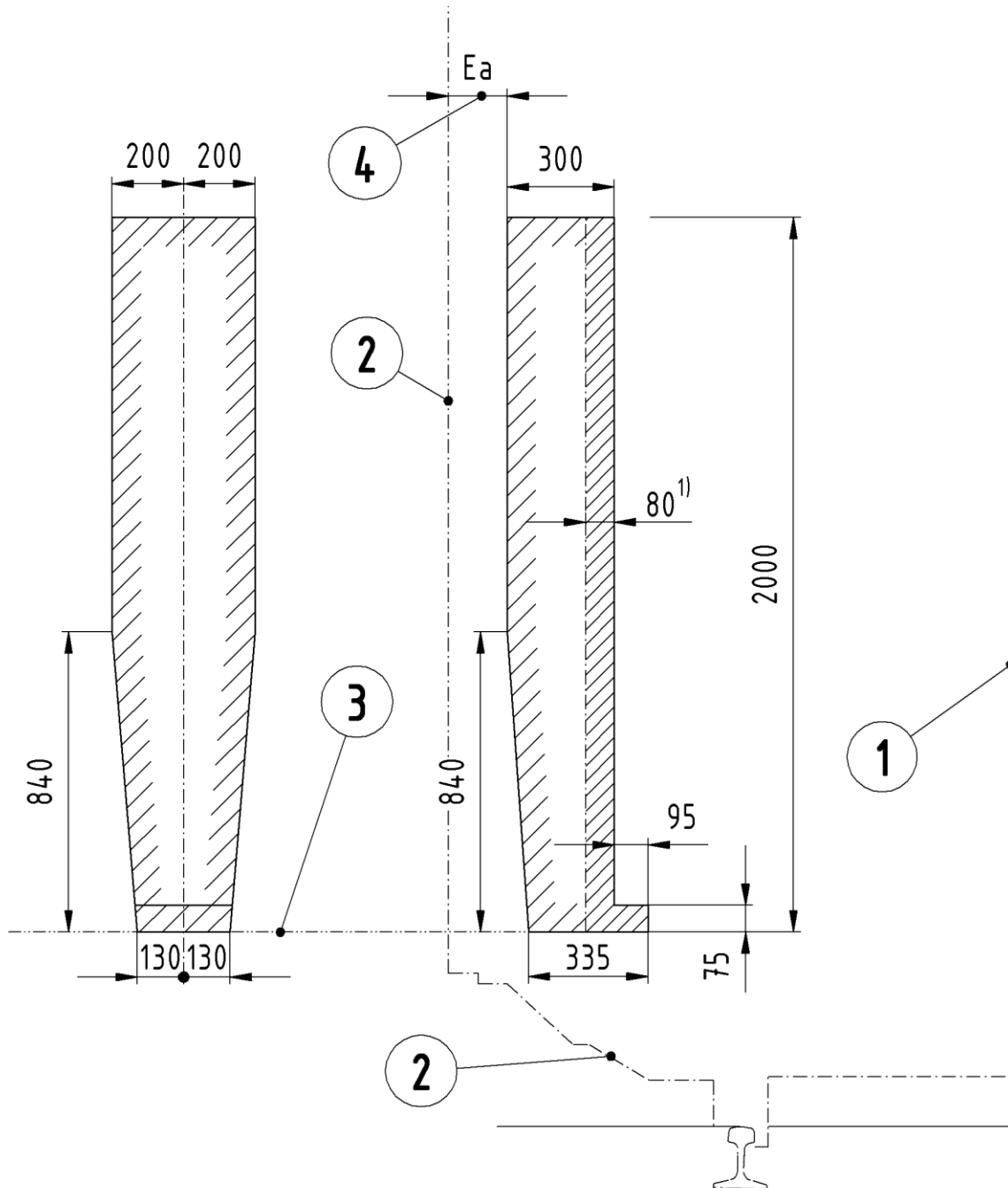
1) In the event of design problems, component parts such as the closing and locking devices of sliding walls may exceptionally infringe this space. These components shall nonetheless be placed parallel to the end wall and have no projecting parts liable to cause injury.

 <b>OTIF</b>	<b>ROLLING STOCK FREIGHT WAGONS</b>			<b>UTP WAG 2015 Page 104 of 133</b>
Status: <b>PROPOSAL</b>	Version: 04	TECH-16014-CTE9-5.1b	Original: EN	Date: 1.4.2016

## **Appendix N: Specifications on slack adjusters**

*This appendix is a transcription of the ERA technical document ERA/TD/2012-05/INT version 1.0 of 04.06.2012 published on the ERA website and as referred to in the WAG TSI:2013. It appears in full width in order to keep the drawings readable.*

### **1. Functional specifications of slack adjusters**

The assembly of the slack adjuster shall be aimed to prevent any partial or full detachment of these components.

A device to automatically maintain the design clearance between the friction pair shall be provided.

A minimum of 15 mm clearance between the slack adjuster envelope and other components shall be provided.

Provision shall be made for the necessary free clearances for the slack adjuster extremities and connections to be maintained at all times.

For slack adjusters within a bogie, there is no special envelope. But, for all design conditions, the minimum clearance necessary between the slack adjuster and other components shall be ensured to prevent contact. Should a smaller clearance be required, the reasons why contact will not occur shall be demonstrated.

### **2. Specifications for slack adjusters**

Slack adjusters are necessary to automatically maintain a nominally constant clearance between the friction pair (wheel and brake block or disc and brake pad) in order to maintain the braking characteristics and guarantee the braking performance.

The slack adjuster shall not absorb more than 2 kN of the brake application force. The performance characteristics of the slack adjuster shall not be varied by environmental conditions (vibrations, winter conditions, etc.).

There is no requirement for interchangeability of slack adjuster, but if they are to be interchangeable the space envelopes as set out in figure 1 and 2 apply (only the values in the table are necessary).

Interchangeable Slack adjusters which are placed within the underframe shall not exceed the space envelopes as set out in figure 1 and 2.



 <b>OTIF</b>	<b>ROLLING STOCK</b> <b>FREIGHT WAGONS</b>		UTP WAG 2015 Page 105 of 133	
	Status: <b>PROPOSAL</b>	Version: 04	TECH-16014-CTE9-5.1b	Original: EN

Figure 1: Space envelope for loads up to a maximum of 75 kN



sequence	length	Attribute of the slack adjuster			
		length to adjust	load	reagent	distance
	L	M			K
1	2325	580	75kN	2kN	83**
2	1876	440			

\* adapted at the wagon

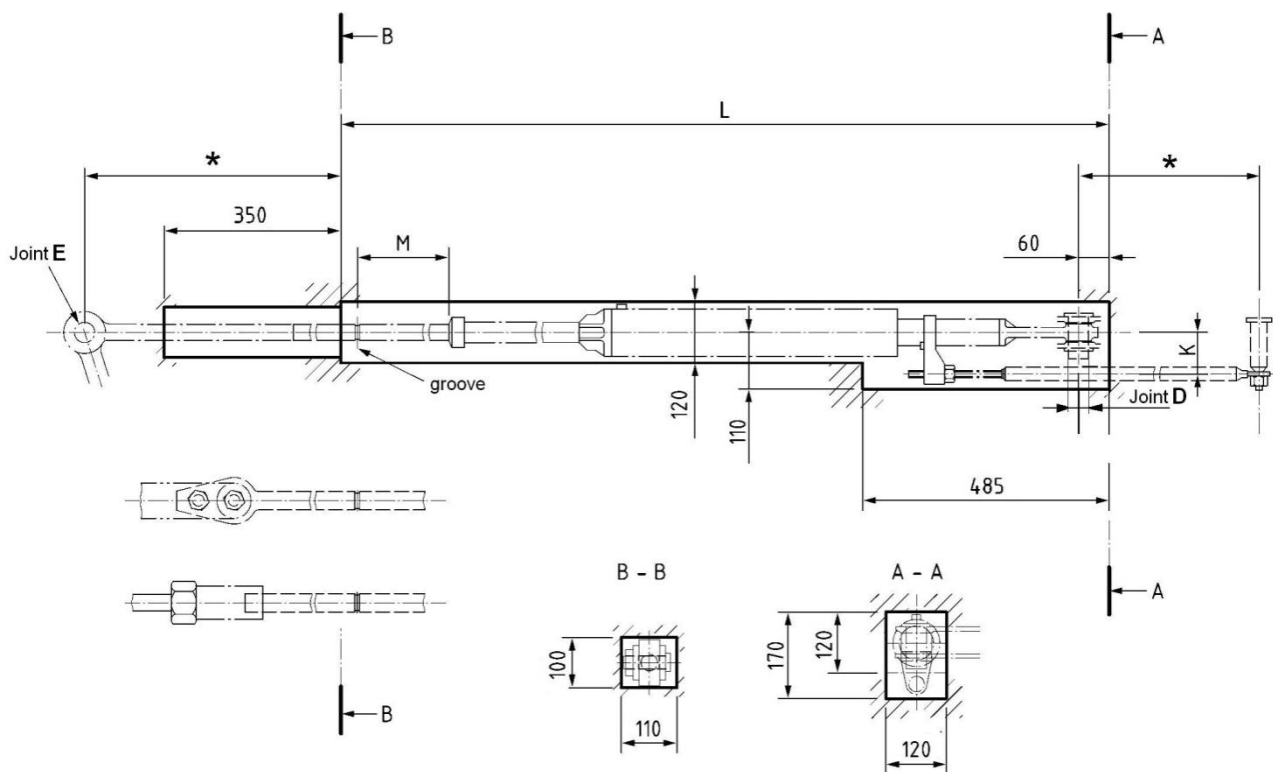
\*\* recommended for new engineering

 <b>OTIF</b>	<b>ROLLING STOCK</b> <b>FREIGHT WAGONS</b>		<b>UTP WAG 2015</b> Page 106 of 133	
	Status: <b>PROPOSAL</b>	Version: 04	TECH-16014-CTE9-5.1b	Original: EN

Figure 2: Space envelope for loads greater than 75 kN



sequence	length	Attribute of the slack adjuster			
		length to adjust	load	reagent	distance
	<b>L</b>	<b>M</b>			<b>K</b>
1	2390	580	75kN	2kN	83**
2	1940	440			
3	1640	280			

\* adapted at the wagon

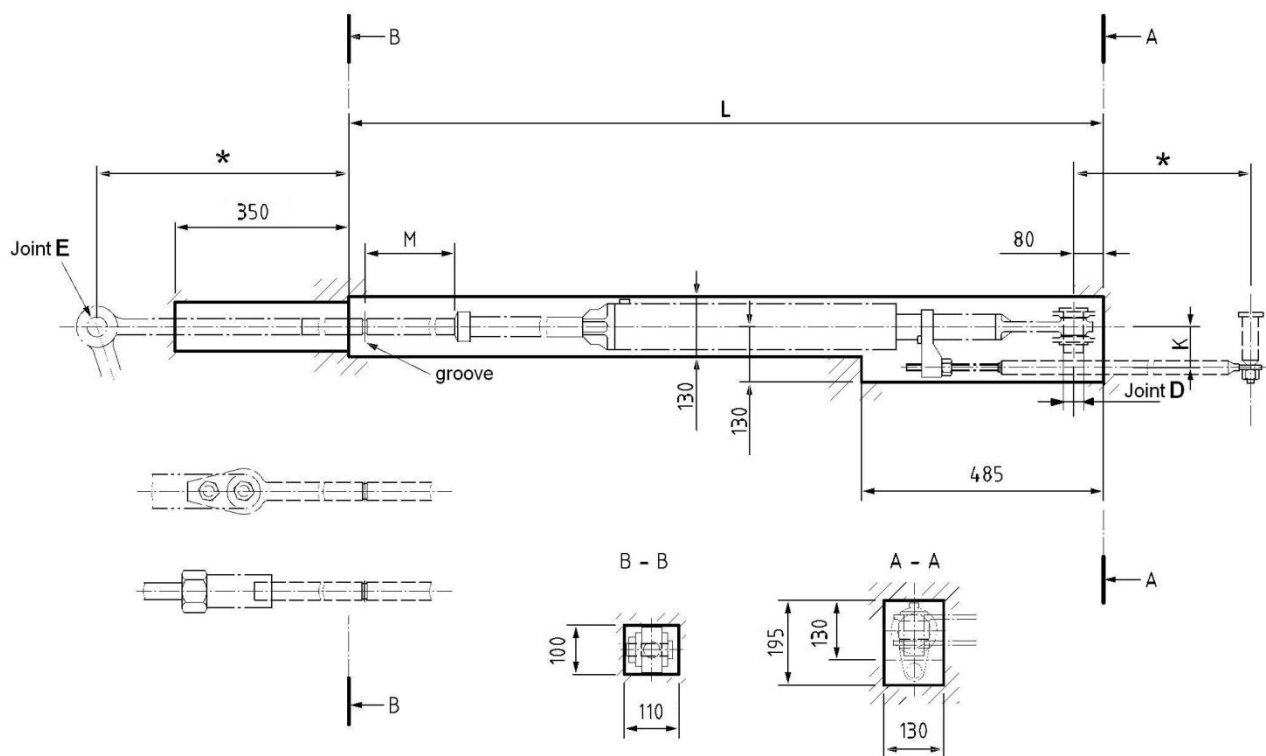
\*\* recommended for new engineering

### 3. Design assessment of slack adjusters

The design assessment of the slack adjuster shall be made by ensuring the mechanical strength is suitable for the load to be transmitted. Interchangeable slack adjusters are shown in chapter 2 with their permitted maximum loads. The assessment will also ensure that the friction pair distance can be maintained within sensible limits so that the friction pair do not touch each other without braking, the braking characteristics are maintained and the braking performance is guaranteed.

A life test shall be performed to demonstrate the suitability of the unit for service on railway vehicles and to verify the maintenance requirements for the operational design life. This shall be carried out at the maximum rated load cycling through the full range of adjustment.

### 4. Product assessment for slack adjusters

Every slack adjuster shall be tested. The features to be tested are:

- Maximum take up
- Maintenance of set clearance

 <b>OTIF</b>	<b>ROLLING STOCK FREIGHT WAGONS</b>			<b>UTP WAG 2015 Page 107 of 133</b>
Status: <b>PROPOSAL</b>	Version: 04	TECH-16014-CTE9-5.1b	Original: EN	Date: 1.4.2016

- Incremental take up
- Letting out when no clearance to obtain set clearance (double acting units only)
- Ability to reset to minimum length (contracting slack adjuster) or maximum length (extending slack adjuster)

|

 <b>OTIF</b>	<b>ROLLING STOCK FREIGHT WAGONS</b>			UTP WAG 2015 Page 108 of 133
	Status: <b>PROPOSAL</b>	Version: 04	TECH-16014-CTE9-5.1b	Original: EN

## **Appendix O: conformity assessment of friction elements for wheel tread brakes**

*This appendix is a transcription of the ERA technical document ERA/TD/2013-02/INT version 2.0 of 15.12.2014 published on the ERA website and as referred to in the WAG TSI. It appears in full width in order to keep the drawings and tables readable.*

### **1. INTRODUCTION**

The present document provides the necessary specifications to perform the assessment of conformity of friction elements for wheel tread brakes. It is referred to in point 6.1.2.5 and Appendix D of the technical specification for interoperability relating to the subsystem ‘rolling stock – freight wagons’ following its amendment related to ‘friction elements for wheel tread brakes’ (ready for adoption in 2015).

The present document is based on FprEN 16452: Railway applications - Braking - Brake blocks, dated March 2014.

### **2. TERMS AND DEFINITIONS**

For the purposes of this document the following terms and definitions apply.

<u>Bg arrangement:</u>	<u>arrangement with one friction element per friction element holder</u>
<u>Bgu arrangement:</u>	<u>arrangement with two friction elements per friction element holder</u>
<u>1Bg:</u>	<u>unilateral configuration with one friction element per friction element holder</u>
<u>2Bg:</u>	<u>bilateral configuration with one friction element per friction element holder</u>
<u>1Bgu:</u>	<u>unilateral configuration with two friction elements per friction element holder</u>
<u>2Bgu:</u>	<u>bilateral configuration with two friction elements per friction element holder</u>
<u>friction element:</u>	<u>stator part of a tread brake adapted to generate a friction force when engaged with a wheel tread</u>
<u>friction element force:</u>	<u>force with which the friction element is made to come into contact with the wheel tread</u>
<u>friction element back plate:</u>	<u>element onto which the friction element is fixed, acting as the interface between the friction element and friction element holder</u>
<u>friction material:</u>	<u>consumable portion of the friction element that acts on the wheel tread in order to provide the specified brake performance</u>
<u>size of friction element:</u>	<u>product of height and width of the friction element without any correction for grooves</u>
<u>instantaneous friction coefficient:</u>	<u>value of friction coefficient at any one instant</u>
<u>mean friction coefficient:</u>	<u>value of instantaneous friction coefficient integrated over distance</u>
<u>dynamic friction coefficient:</u>	<u>coefficient of friction achieved by the friction material during relative movement between the friction material surface and wheel tread</u>
<u>static friction coefficient:</u>	<u>coefficient of friction achieved by the friction material at the point where relative movement between the friction material surface and wheel tread starts to take place</u>

 <b>OTIF</b>	<b>ROLLING STOCK</b> <b>FREIGHT WAGONS</b>		UTP WAG 2015 Page 109 of 133
	Status: <b>PROPOSAL</b>	Version: 04	TECH-16014-CTE9-5.1b

parking brake: brake used to prevent a stationary train from moving under specified conditions, until intentionally released (also called ‘immobilization braking’)

wheel tread temperature: average temperature out of three values measured by three rubbing thermocouples spaced equally across the wheel tread

### **3. ABBREVIATIONS**

<u><math>m</math></u>	[t]	Mass to be braked per wheel for design mass (including rotating mass) in conformity with EN 15663
<u><math>m_1</math></u>	[t]	Mass $m$ in working order
<u><math>m_2</math></u>	[t]	Mass $m$ under normal payload
<u><math>m_{IW}</math></u>	[t]	Mass $m$ in working order divided by the number of wheels
<u><math>F_B</math></u>	[kN]	Nominal brake application force per wheel
<u><math>F_{B1}</math></u>	[kN]	Total friction element application force per wheel for braked mass $m_1$
<u><math>F_{B2}</math></u>	[kN]	Total friction element application force per wheel for braked mass $m_2$
<u><math>F_b</math></u>	[kN]	Instantaneous application force per wheel
<u><math>F_{PB}</math></u>	[kN]	Parking brake application force
<u><math>v</math></u>	[km/h]	Theoretical initial speed at the brake application initiation
<u><math>v_m</math></u>	[km/h]	Maximum service speed
<u><math>\mu_0</math></u>	[-]	Instantaneous friction coefficient determined at every instance of the braking by the ratio between the total brake force $F_{IR}$ and the total application force $F_b$
<u><math>\mu_m</math></u>	[-]	Mean friction coefficient determined from reaching 95 % of the nominal application force $F_B$ of the instantaneous friction coefficient $\mu_0$ for the stopping distance $s_2$
<u><math>\mu_{dyn}</math></u>	[-]	Dynamic friction coefficient
<u><math>\mu_{stat}</math></u>	[-]	Static friction coefficient
<u><math>\theta_0</math></u>	[°C]	Mean initial temperature of the wheel tread at the beginning of the brake application
<u><math>s_1</math></u>	[m]	Stopping distance from beginning of the brake application to rest
<u><math>s_2</math></u>	[m]	Stopping distance from the moment on when $F_b = 0.95 F_B$ to rest
<u><math>D</math></u>	[mm]	Diameter of wheel
<u><math>P</math></u>	[-]	Brake type – P = passenger

### **4. DYNAMIC FRICTION COEFFICIENT**

#### **4.1 Test program**

The dynamometer test program for friction elements for wheel tread brakes to determine the dynamic friction coefficient  $\mu_{dyn}$  is set out in table 1. The corresponding terms, definitions and abbreviations are explained in sections 2 and 3.

**Table 1:** Dynamometer test program to determine the dynamic friction coefficient

<b><u>Friction element arrangement</u></b>	<u>To be defined by the applicant</u>
--------------------------------------------	---------------------------------------



Status: <b>PROPOSAL</b>	Version: 04	TECH-16014-CTE9-5.1b	Original: EN	Date: 1.4.2016
-------------------------	-------------	----------------------	--------------	----------------

<u>Wheel type</u>	<u>In conformity with EN 13979-1</u>					
<u>Wheel diameter</u>	<u><math>\varnothing X \pm 5</math> mm last machining size before wheel is fully worn in accordance with EN 13979-1</u>					
<u>Water flow rate</u>	<u>X l/h (without specific requirements 14 l/h should be used)</u>					
<u>No. of brake application</u>	<u>Initial speed</u>	<u>Total <math>F_B</math> per wheel</u>	<u>Initial temp.</u>	<u>Mass to brake per wheel</u>	<u>Weighing after</u>	<u>Remarks</u>
	<u>v</u>	<u><math>F_B</math></u>	<u><math>\theta_0</math></u>	<u>m</u>		
	<u>[km/h]</u>	<u>[kN]</u>	<u>[°C]</u>	<u>[t]</u>	<u>No.</u>	
<u>1.1 - 1.X</u>	<u><math>\frac{3}{4} v_m</math></u>	<u><math>\frac{2}{3} F_{B2}</math></u>	<u>20-100</u>	<u><math>m_2</math></u>	<u>1.X</u>	<u>Brake applications to rest under dry conditions to allow bedding of the friction elements up to at least 85 % of the friction element surface</u>
<u><math>\frac{1}{2}</math></u> <u><math>\frac{3}{4}</math></u> <u><math>\frac{5}{6}</math></u>	<u><math>\frac{3}{4} v_m</math></u> <u><math>v_m</math></u>	<u><math>F_{B2}</math></u>	<u>50-60</u>	<u><math>m_2</math></u>		<u>Brake applications to rest under dry conditions, after a period of cooling</u>
<u>7 to 26</u>	<u><math>\frac{3}{4} v_m</math></u>	<u><math>\frac{2}{3} F_{B1}</math></u>	<u>20-100</u>	<u><math>m_1</math></u>		<u>Conditioning stops</u>
<u>27</u> <u>28</u> <u>29</u> <u>30</u>	<u><math>\frac{3}{4} v_m</math></u> <u><math>\frac{1}{4} v_m</math></u> <u><math>v_m</math></u> <u><math>\frac{1}{2} v_m</math></u>	<u><math>\frac{2}{3} F_{B1}</math></u>	<u>50-60</u>	<u><math>m_1</math></u>		<u>Brake applications to rest under dry conditions, after a period of cooling</u>
<u>31</u> <u>32</u> <u>33</u> <u>34</u>	<u><math>\frac{3}{4} v_m</math></u> <u><math>\frac{1}{4} v_m</math></u> <u><math>v_m</math></u> <u><math>\frac{1}{2} v_m</math></u>	<u><math>\frac{1}{3} F_{B1}</math></u>	<u>50-60</u>	<u><math>m_1</math></u>		<u>Brake applications to rest under dry conditions, after a period of cooling</u>
<u>35</u> <u>36</u> <u>37</u> <u>38</u>	<u><math>\frac{3}{4} v_m</math></u> <u><math>\frac{1}{4} v_m</math></u> <u><math>v_m</math></u> <u><math>\frac{1}{2} v_m</math></u>	<u><math>F_{B1}</math></u>	<u>50-60</u>	<u><math>m_1</math></u>		<u>Brake applications to rest under dry conditions, after a period of cooling</u>

**Table 1** (continued)

<u>No. of brake application</u>	<u>Initial speed</u>	<u>Total <math>F_B</math> per wheel</u>	<u>Initial temp.</u>	<u>Mass to brake per wheel</u>	<u>Weighing after</u>	<u>Remarks</u>
	<u>v</u>	<u><math>F_B</math></u>	<u><math>\theta_0</math></u>	<u>m</u>		
	<u>[km/h]</u>	<u>[kN]</u>	<u>[°C]</u>	<u>[t]</u>	<u>No.</u>	



Status: <b>PROPOSAL</b>	Version: 04	TECH-16014-CTE9-5.1b	Original: EN	Date: 1.4.2016
-------------------------	-------------	----------------------	--------------	----------------

<u>51</u>			$\frac{3}{4} v_m$	=	=	=		<u>10 kW drag brake application for a period of 15 min in dry condition done immediately after brake n° 50 without interruption. This is to evenly distribute the residual stress within the wheel</u>
<u>52</u>	<u>64</u>	<u>76</u>	$\frac{3}{4} v_m$	$\frac{2}{3} F_{B1}$	<u>20-30</u>	$m_1$		<u>Brake applications to rest under wet conditions, after a period of cooling</u>
<u>53</u>	<u>65</u>	<u>77</u>	$\frac{1}{4} v_m$					
<u>54</u>	<u>66</u>	<u>78</u>	$v_m$					
<u>55</u>	<u>67</u>	<u>79</u>	$\frac{1}{2} v_m$					
<u>56</u>	<u>68</u>	<u>80</u>	$\frac{3}{4} v_m$	$\frac{1}{3} F_{B1}$	<u>20-30</u>	$m_1$		<u>Brake applications to rest under wet conditions, after a period of cooling</u>
<u>57</u>	<u>69</u>	<u>81</u>	$\frac{1}{4} v_m$					
<u>58</u>	<u>70</u>	<u>82</u>	$v_m$					
<u>59</u>	<u>71</u>	<u>83</u>	$\frac{1}{2} v_m$					
<u>60</u>	<u>72</u>	<u>84</u>	$\frac{3}{4} v_m$	$F_{B1}$	<u>20-30</u>	$m_1$		<u>Brake applications to rest under wet conditions, after a period of cooling</u>
<u>61</u>	<u>73</u>	<u>85</u>	$\frac{1}{4} v_m$					
<u>62</u>	<u>74</u>	<u>86</u>	$v_m$					
<u>63</u>	<u>75</u>	<u>87</u>	$\frac{1}{2} v_m$					
<u>88</u>	<u>92</u>		$\frac{3}{4} v_m$	$F_{B2}$	<u>20-30</u>	$m_2$		<u>Brake applications to rest under wet conditions, after a period of cooling</u>
<u>89</u>	<u>93</u>		$\frac{1}{4} v_m$					
<u>90</u>	<u>94</u>		$v_m$					
<u>91</u>	<u>95</u>		$\frac{1}{2} v_m$					
<u>96</u>			$\frac{3}{4} v_m$	=	=	=	<u>96</u>	<u>10 kW drag brake application for a period of 15 min in dry condition done immediately after brake n° 95 without interruption to dry the friction element</u>
<u>97</u>	<u>109</u>		$\frac{3}{4} v_m$	$\frac{2}{3} F_{B2}$	<u>50-60</u>	$m_2$		<u>Brake applications to rest under dry conditions, after a period of cooling</u>
<u>98</u>	<u>110</u>		$\frac{1}{4} v_m$					
<u>99</u>	<u>111</u>		$v_m$					
<u>100</u>	<u>112</u>		$\frac{1}{2} v_m$					
<u>101</u>	<u>113</u>		$\frac{3}{4} v_m$	$\frac{1}{3} F_{B2}$	<u>50-60</u>	$m_2$		<u>Brake applications to rest under dry conditions, after a period of cooling</u>
<u>102</u>	<u>114</u>		$\frac{1}{4} v_m$					
<u>103</u>	<u>115</u>		$v_m$					
<u>104</u>	<u>116</u>		$\frac{1}{2} v_m$					

**Table 1 (continued)**

<u>No. of brake application</u>	<u>Initial speed</u>	<u>Total F<sub>B</sub> per wheel</u>	<u>Initial temp.</u>	<u>Mass to brake per wheel</u>	<u>Weighing after</u>	<u>Remarks</u>
	$v$	$F_B$	$\theta_0$	$m$		
	<u>[km/h]</u>	<u>[kN]</u>	<u>[°C]</u>	<u>[t]</u>	<u>No.</u>	



Status: <b>PROPOSAL</b>	Version: 04	TECH-16014-CTE9-5.1b	Original: EN	Date: 1.4.2016
-------------------------	-------------	----------------------	--------------	----------------

<u>105</u>	<u>117</u>	$\frac{3}{4} v_m$					<u>Brake applications to rest under dry conditions, after a period of cooling</u>
<u>106</u>	<u>118</u>	$\frac{1}{4} v_m$	$F_{B2}$	<u>50-60</u>	$m_2$		
<u>107</u>	<u>119</u>	$v_m$					
<u>108</u>	<u>120</u>	$\frac{1}{2} v_m$					
<u>121</u>		$\frac{3}{4} v_m$					<u>Brake applications to rest under dry conditions with high initial temperature, after a period of cooling</u>
<u>122</u>		$\frac{1}{4} v_m$	$F_{B2}$	<u>110-120<sup>a</sup></u>	$m_2$		
<u>123</u>		$v_m$					
<u>124</u>		$\frac{1}{2} v_m$					
<u>125</u>		$\frac{3}{4} v_m$					<u>Brake applications to rest under dry conditions, after a period of cooling</u>
<u>126</u>		$\frac{1}{4} v_m$	$\frac{2}{3} F_{B2}$	<u>50-60</u>	$m_2$	<u>128</u>	
<u>127</u>		$v_m$					
<u>128</u>		$\frac{1}{2} v_m$					
<u>129</u>		$\frac{3}{4} v_m$	=	<u>20-60</u>	=		<u>Simulation of a downhill brake application with a power of 45 kW for a period of 34 min</u>
<u>130</u>		$\frac{3}{4} v_m$	$F_{B2}$	=	$m_2$		<u>Brake application to rest under dry conditions immediately after the simulation of a downhill brake application, without any cooling break</u>
<u>131 to 140</u>		$v_m$	$\frac{2}{3} F_{B2}$	<u>50-60</u>	$m_2$		<u>Conditioning stops</u>
<u>141</u>	<u>145</u>	$\frac{3}{4} v_m$					<u>Brake applications to rest under dry conditions, after a period of cooling</u>
<u>142</u>	<u>146</u>	$\frac{1}{4} v_m$	$F_{B2}$	<u>50-60</u>	$m_2$	<u>148</u>	
<u>143</u>	<u>147</u>	$v_m$					
<u>144</u>	<u>148</u>	$\frac{1}{2} v_m$					
<u>149</u>		$\frac{3}{4} v_m$	=	=	=		<u>10 kW drag brake application for a period of 10 min in dry condition done immediately after brake n° 148 without interruption. This is to evenly distribute the residual stress within the wheel</u>

<sup>a</sup> If the temperature obtained during stop numbers 120 and 122 is below 110 °C, stop numbers 121 and 123 shall be performed with the temperature achieved at the time.

During the tests described in table 1 the following conditions shall be respected:

- The speed and ventilation conditions shall be as set out in table 2.

**Table 2:** Speed and ventilation conditions

	<u>Speed simulated on the test bench [km/h]</u>		<u>Speed of the cooling air [km/h]</u>	
	<u>Under dry conditions</u>	<u>Under wet conditions</u>	<u>Under dry conditions</u>	<u>Under wet conditions</u>



 <b>OTIF</b>	<b>ROLLING STOCK</b> <b>FREIGHT WAGONS</b>			UTP WAG 2015 Page 113 of 133
	Status: <b>PROPOSAL</b>	Version: 04	TECH-16014-CTE9-5.1b	Original: EN

<u>During braking at</u> <u>v ≤ 80km/h</u> <u>v &gt; 80km/h</u>	<u>v</u>	<u>v</u>	<u>v/2</u>	<u>10</u>
	<u>v</u>	<u>v</u>	<u>40</u>	<u>10</u>
<u>Between the brake applications</u>	<u>100</u>	<u>50</u>	<u>40</u>	<u>10</u>

- The time to reach 95 % of the demanded  $F_B$  shall be  $4 \text{ s} \pm 0,2 \text{ s}$ .
- During bedding-in the following minimum numbers of brake stops shall be carried out: 40 for organic friction elements and 80 for sintered friction elements.
- If interruptions of the test program occur, before recommencing the program the previous 5 stops shall be repeated. In this case the initial temperature for the first stop shall be in the range from 20 °C to 60 °C.
- In the case of an interruption prior to the first wet stop, one brake application identical to the last brake application under dry conditions shall be carried out outside of the program.
- Concerning the brake applications under wet conditions, the wheel wetting shall not be interrupted during each entire set of stops under wet conditions (including cooling period). For any first stop under wet conditions after a stop under dry conditions, the start of the wheel tread wetting shall take place only when the temperature of the wheel tread is below 80 °C.
- During the test under wet conditions the water shall be equally distributed over the wheel tread.
- During the simulation of a downhill the chosen power and speed shall be kept constant.

## **4.2 Values to be determined in order to define the area of use**

The values for the following parameters shall be determined and recorded within the area of use:

a) Tested configuration consisting of

\_\_\_\_\_ - friction element arrangement

\_\_\_\_\_ - wheel type

\_\_\_\_\_ - nominal and tested wheel diameter

b) Mean dynamic friction coefficient of non-bedded and bedded state. The mean dynamic friction coefficient of the non-bedded and bedded state are defined as the average of the first 5 and the last 5 measured values of brake application n° 1.1 to 1.X.

c) Mean dynamic friction coefficient under dry conditions versus the initial operating speed v for the different brake forces  $F_B$  applied and the mass to brake per wheel m using the template diagrams set out in table 3.

**Table 3: Template diagrams and allocated brake application n°**

 <b>OTIF</b>	<b>ROLLING STOCK FREIGHT WAGONS</b>			UTP WAG 2015 Page 114 of 133
	Status: <b>PROPOSAL</b>	Version: 04	TECH-16014-CTE9-5.1b	Original: EN

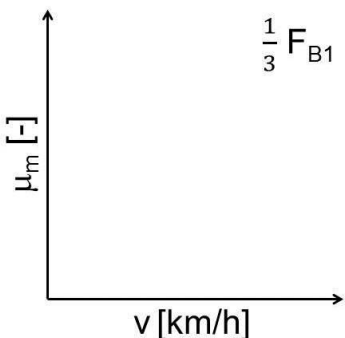
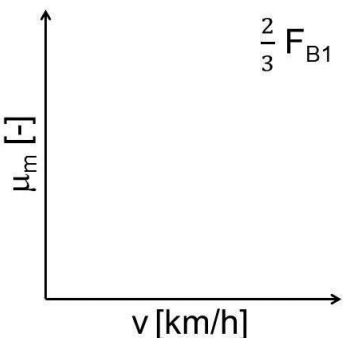
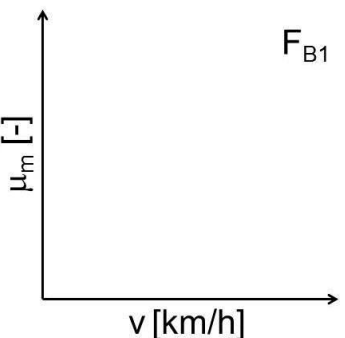
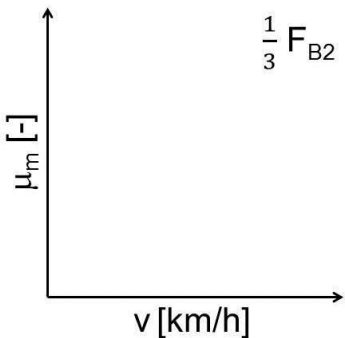
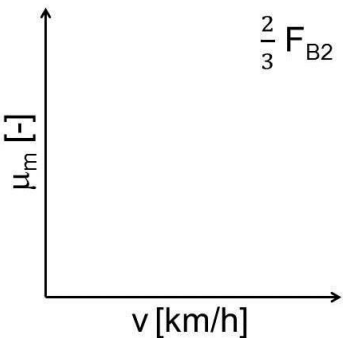
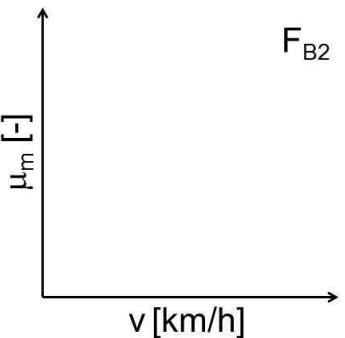
		
<u>Brake application n° 31 to 34 and 43 to 46</u>	<u>Brake application n° 27 to 30 and 39 to 42</u>	<u>Brake application n° 35 to 38 and 47 to 50</u>
		
<u>Brake application n° 101 to 104 and 113 to 116</u>	<u>Brake application n° 97 to 100 and 109 to 112</u>	<u>Brake application n° 105 to 108 and 117 to 120</u>

- d) Mean dynamic friction coefficient variation under wet conditions. The variation shall be expressed as the averages of the measured mean dynamic friction coefficients under wet conditions (brake application n° 52 to 95) in proportion to the corresponding averages of mean dynamic friction coefficients under dry conditions (brake application n° 27 to 50, 105 to 108 and 117 to 120). Example: the average value of brake applications n° 57, 69 and 81 divided by the average value of brake applications n° 32 and 44.
- e) Mean dynamic friction coefficient variation at high initial temperature. The variation shall be expressed as the mean dynamic friction coefficients at a wheel tread temperature above 110 °C (brake application n° 121 to 124) in proportion to the corresponding mean dynamic friction coefficients at a wheel tread temperature below 60 °C (brake application n° 125 to 128). Example: The value of brake application n° 122 divided by the value of brake applications n° 126.
- f) Chart of the instantaneous dynamic friction coefficient and wheel tread temperature versus time of brake application n° 129.
- g) Mean dynamic friction coefficient variation after simulation of a downhill brake application. The variation shall be expressed as the averages of the measured mean dynamic friction coefficients after downhill braking (brake application n° 141 to 148) in proportion to the corresponding averages of mean dynamic friction coefficients before downhill braking (brake application n° 105 to 108 and 117 to 120). Example: the average value of brake applications n° 142 and 146 divided by the average value of brake applications n° 106 and 118.



Status: <b>PROPOSAL</b>	Version: 04	TECH-16014-CTE9-5.1b	Original: EN	Date: 1.4.2016
-------------------------	-------------	----------------------	--------------	----------------

In relation to the characteristics described in this chapter, in case the manufacturer chooses to apply some of the harmonised acceptance criteria for dynamic friction performance as specified in FprEN 16452:2014<sup>58</sup>, the compliance to these harmonised acceptance criteria have to be stated in the technical documentation as part of the area of use of the friction element for wheel tread brakes.

## **5. STATIC FRICTION COEFFICIENT**

### **5.1 Test program**

The dynamometer test program to determine the static friction coefficient  $\mu_{stat}$  of friction elements for wheel tread brakes is set out in table 4. The corresponding terms, definitions and abbreviations are explained in sections 2 and 3.

**Table 4:** Dynamometer test program to determine the static friction coefficient

<b><u>Friction element configuration</u></b>	<b><u>To be defined by the applicant</u></b>				
<b><u>Wheel type</u></b>	<b><u>In conformity with EN 13979-1</u></b>				
<b><u>Wheel diameter</u></b>	<b><u><math>\varnothing X \pm 5</math> mm last machining size before wheel is fully worn in accordance with EN 13979-1</u></b>				
<b><u>No. of brake application</u></b>	<b><u>Initial speed</u></b>	<b><u>Parking brake application force</u></b>	<b><u>Initial temp.</u></b>	<b><u>Mass to brake per wheel</u></b>	<b><u>Remarks</u></b>
	<b><u><math>v</math></u></b>	<b><u><math>F_{PB}</math></u></b>	<b><u><math>\vartheta_0</math></u></b>	<b><u><math>m</math></u></b>	
	<b><u>[km/h]</u></b>	<b><u>[kN]</u></b>	<b><u>[°C]</u></b>	<b><u>[t]</u></b>	
<b><u>R.1 - R.X</u></b>	<b><u><math>v_m</math></u></b>	<b><u><math>\frac{2}{3} F_{PBmax}</math></u></b>	<b><u>20-100</u></b>	<b><u><math>m_2</math></u></b>	<b><u>Brake applications to rest under dry conditions to allow bedding of the friction elements up to a contact pattern of 100 % is reached</u></b>
<b><u>1 to 5</u></b> <b><u>6 to 10</u></b> <b><u>11 to 15</u></b> <b><u>16 to 20</u></b>	<b><u>=</u></b>	<b><u><math>\frac{1}{4} F_{PBmax}</math></u></b> <b><u><math>\frac{1}{2} F_{PBmax}</math></u></b> <b><u><math>\frac{3}{4} F_{PBmax}</math></u></b> <b><u><math>F_{PBmax}</math></u></b>	<b><u>&lt; 30</u></b>	<b><u>=</u></b>	<b><u>=</u></b>

During the test described in table 4 the following conditions shall be respected:

- The wheel tread hollow wear at the start of the test shall not exceed 1 mm. The state of the surface of the wheel tread shall be documented in the test report.
- The torque shall be continuously increased. The start of the rotation shall occur between 0,3 s and 2,0 s after the beginning of the build-up of the rotating torque.

<sup>58</sup> The reference will be changed to EN 16452:xxxx once this standard is published. FprEN is a stable version submitted to the formal vote within CEN.

 <b>OTIF</b>	<b>ROLLING STOCK FREIGHT WAGONS</b>			UTP WAG 2015 Page 116 of 133
	Status: <b>PROPOSAL</b>	Version: 04	TECH-16014-CTE9-5.1b	Original: EN

- The relative movement between wheel and friction element shall be measured with an accuracy of at least 30 milliradian. It shall be ensured that displacements due to clearances are excluded.

For each brake application (n° 1 to 20) the static friction coefficient shall be determined which is the value of the instantaneous friction coefficient at the time corresponding to the commencement of sliding (mean value calculated from the measurement records for the intersection between the linearised characteristic line of the rotation angle and the time axis) as described in figure 1.

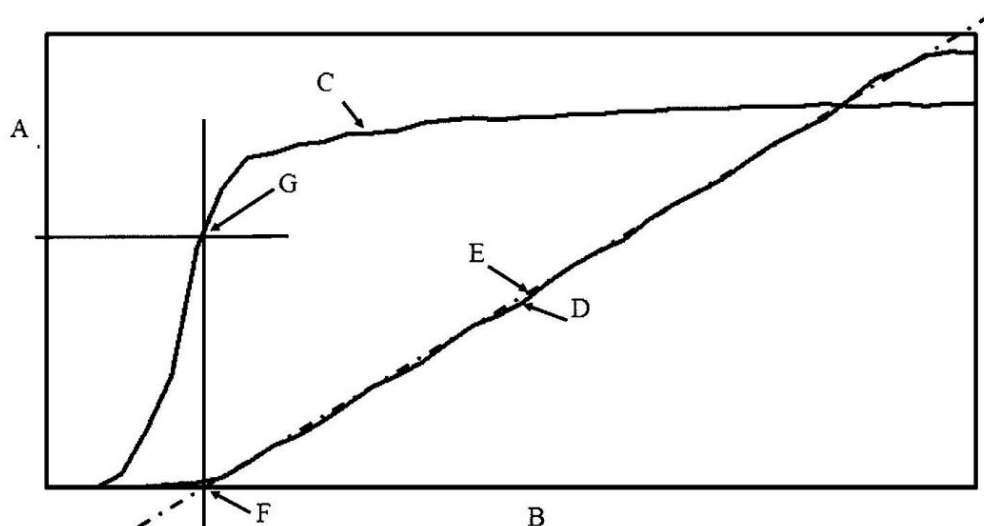

#### Key

- A friction coefficient ( $\mu$ ) / rotation angle of wheel
- B time axis
- C example of friction coefficient curve
- D rotation angle of wheel
- E straight regression line
- F intersection between straight regression line and time axis
- G value of static coefficient

**Figure 1:** Principles for the determination of the static friction coefficient

## 5.2 Values to be determined in order to define the area of use

For each force the average value of the 5 measurements shall be determined. The lowest average value is the characterising static friction coefficient.

## 6. MECHANICAL CHARACTERISTICS

The mechanical characteristics of the assembly between back plate and friction element for wheel tread brakes shall be tested in accordance with the test procedures set out in sections 6.1 and 6.2.

### 6.1 Shear strength

The test shall be performed with the mounting as set out in figure 2. In the case of a friction element consisting of two parts or a mono-bloc friction element with a central groove, a wedge (g) shall be placed in the central groove as shown.

 <b>OTIF</b>	<b>ROLLING STOCK</b> <b>FREIGHT WAGONS</b>		<b>UTP WAG 2015</b> <b>Page 117 of 133</b>	
	Status: <b>PROPOSAL</b>	Version: 04	TECH-16014-CTE9-5.1b	Original: EN

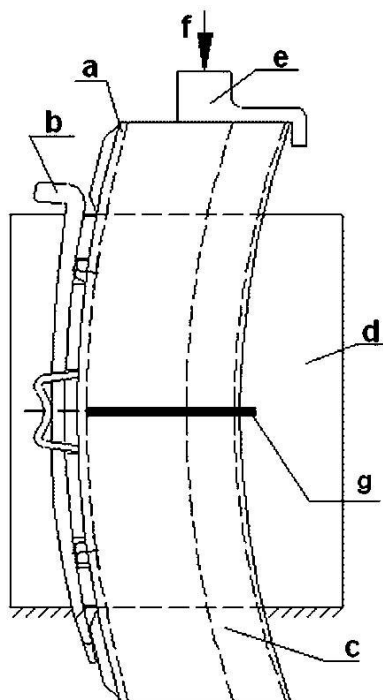

### Key

- a brake shoe insert back plate
- b brake shoe insert fixing key
- c friction element
- d side panel
- e force application fixing
- f test force  $F_{test}$
- g brake shoe insert groove filling device

**Figure 2:** Shear strength test mounting arrangement

The test force  $F_{test}$  shall be applied in a continuous and progressive way up to 1.5 times the maximum permissible braking force applied at one friction element within 4 s and shall be kept for a period of at least 2 min.

At the end of the test there shall not be any indication of detachment of the back plate from the friction element or any other visible mechanical damage.

## **6.2 Flexural strength**

Two tests shall be performed, one with the mounting 1 and one with the mounting 2 as set out in figure 3. The end of the supports shall have a radius of 5 mm. For both tests new friction elements shall be used and the test force  $F_{test}$  shall be applied five times.  $F_{test}$  is the maximum permissible application force applied at one friction element.

The following distances shall be respected:

 <b>OTIF</b>	<b>ROLLING STOCK</b> <b>FREIGHT WAGONS</b>		<b>UTP WAG 2015</b> Page 118 of 133	
	Status: <b>PROPOSAL</b>	Version: 04	TECH-16014-CTE9-5.1b	Original: EN

- Ls 1 = friction element length - 50 mm.
- Ls 2 = half friction element length - 50 mm.

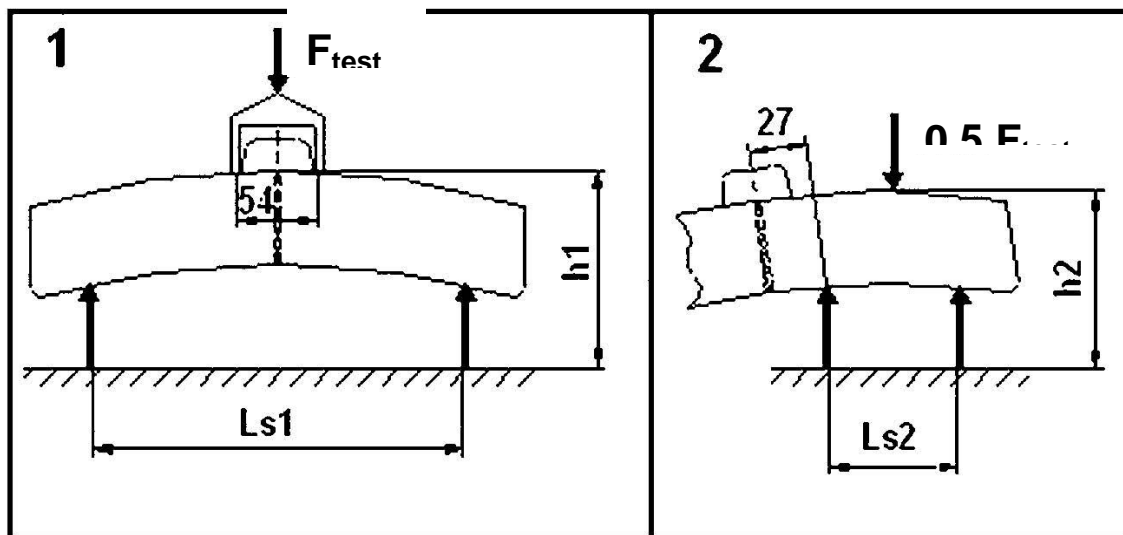

#### Key

1 mounting for performing test n°1

2 mounting for performing test n°2

**Figure 3:** Flexural strength test mounting arrangement

Within 4 s the test force shall be applied progressively until either the maximum test force  $F_{test}$  is achieved or the maximum displacement  $\square h1$  respectively  $\square h2$  for the intended application occurs taking into account the nominal geometry of a new friction element and a new wheel.

The force respectively the displacement shall be kept for a period of at least 2 minutes.

At the end of the test, the friction element shall not show any crack initiation or fracture of the back plate. In the case of a friction element that has a groove or slot as shown in figure 3 cracking is permitted in the area where the friction element is at its thinnest where the groove meets the back plate.

## 7. SUITABILITY FOR TRAIN DETECTION BY SYSTEMS BASED ON TRACK CIRCUITS

The following rig test to demonstrate the suitability for train detection by systems based on track circuits is only applicable if the friction element is intended to be used in subsystems which fall under the following scope:

- Nominal wheel diameters of 680 mm to 920 mm
- Friction element configurations 1Bg, 1Bgu, 2Bg and 2Bgu
- Mass per wheel  $\geq 1.8$  t

Cast iron brake blocks are deemed to be suitable for train detection by systems based on track circuits.

### 7.1 Test program

 <b>OTIF</b>	<b>ROLLING STOCK</b> <b>FREIGHT WAGONS</b>		<b>UTP WAG 2015</b> <b>Page 119 of 133</b>	
	Status: <b>PROPOSAL</b>	Version: 04	TECH-16014-CTE9-5.1b	Original: EN

A number of 10 friction element samples of a given size as set out in clause 7.1.3 shall be subject to the test program provided in figure 4 and further described in clauses 7.1.1 to 7.1.6.

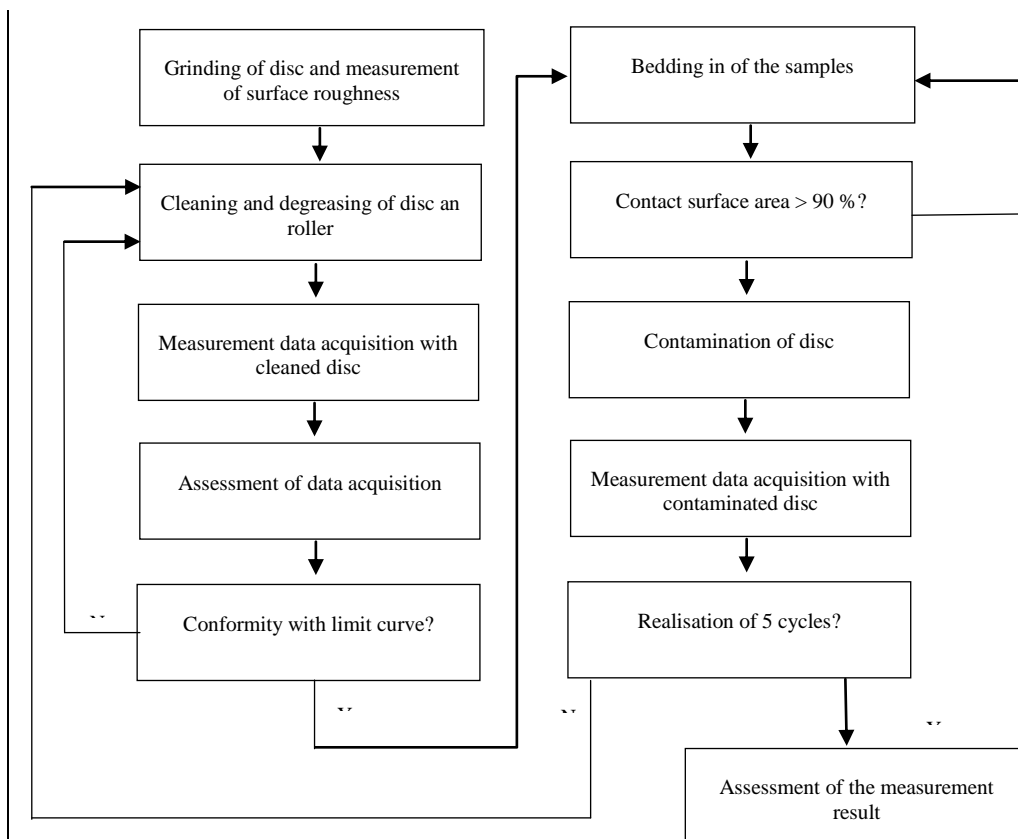

**Figure 4:** Flow chart of the test program

### **7.1.1 Grinding of disc and measurement of surface roughness**

Before the first test of each pair of friction element samples the disc shall be grinded and the surface roughness  $R_z$  (maximum height of profile) shall be lower than or equal to 12  $\mu\text{m}$ .

### **7.1.2 Cleaning and degreasing of disc and roller**

The disc shall be cleaned and degreased with emery paper of grade 180, cloths in micro-fibres and of water/spray acetone in order to remove the residual material and satins from previous tests.

The roller and the surface of the carbon brush shall be cleaned and degreased in order to remove dust particles adhering to the surface.

### **7.1.3 Cutting of the samples**

The cutting of samples shall be carried out without lubrication. The samples shall be cut along the friction surface of the friction element. The friction surface of the samples shall be the one which was originally the closest to the friction surface of the friction element in order to maintain the original application orientation of the material. The sample dimensions are provided in figure 5.

 <b>OTIF</b>	<b>ROLLING STOCK</b> <b>FREIGHT WAGONS</b>		<b>UTP WAG 2015</b> <b>Page 120 of 133</b>	
	Status: <b>PROPOSAL</b>	Version: 04	TECH-16014-CTE9-5.1b	Original: EN

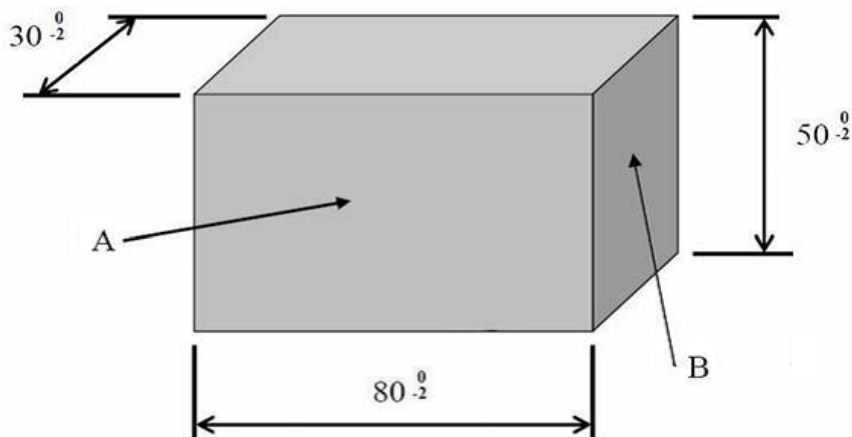

#### **Key**

**A** Friction surface of a sample

**B** Other surface

**Figure 5:** Sample

#### **7.1.4 Bedding in of samples**

For each cycle two new samples shall be bedded in. The bedding in shall be performed by stop brakings on the cleaned and degreased disc under the following conditions:

- Speed of 100 km/h in the centre of the samples' friction surface
- Braked mass of 0,41 t
- Surface pressure of 40 N/cm<sup>2</sup>

The bedding in shall achieve a contact surface area of more than 90 %.

#### **7.1.5 Contamination of disc**

The disc shall be contaminated by continuous braking under the following conditions:

- Speed of 70 km/h in the centre of the samples' friction surface
- Brake torque of 51 Nm
- The contamination phase ends as soon as the disc temperature has reached 400 °C or after 2 400 s of continuous braking

Before carrying out the measurement as described in clause 7.1.6 the disc shall be cooled down below 40 °C.

#### **7.1.6 Measurements**

The measurement of the impedance shall be carried out with a measurement set up as schematically described in figure 6.



 <b>OTIF</b>	<b>ROLLING STOCK</b> <b>FREIGHT WAGONS</b>		UTP WAG 2015 Page 121 of 133	
	Status: <b>PROPOSAL</b>	Version: 04	TECH-16014-CTE9-5.1b	Original: EN

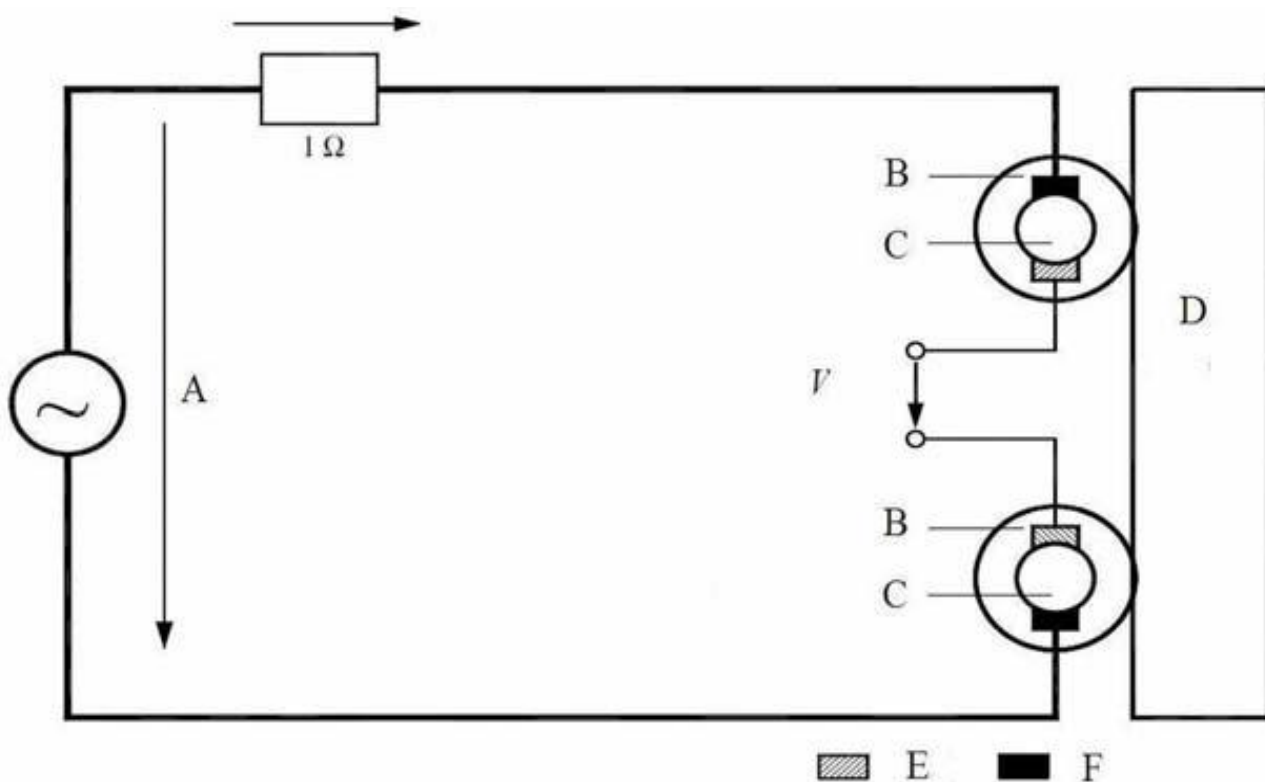

**Key**

- A Applied voltage (electrical cycle)
- B Roller made of rail steel
- C Shaft made of copper
- D Disc made of wheel steel (clean/contaminated)
- E Carbon brush – measured voltage
- F Carbon brush – applied voltage
- V Measured voltage

**Figure 6:** Schematic diagram of the measurement set up

The electrical contact to the disc is achieved by means of two rollers with a contact force of 14 N each (view of rollers, shaft and brushes in figure 6 are rotated by 90°).

The impedance measurement

- of the cleaned disc and
- of the contaminated disc

relates to four different measuring traces equally distributed over the radius in the contaminated area. In accordance with figure 4 five measurement cycles shall be conducted, so that the impedance of 20 traces is measured at a total.

The impedance on each trace is measured both statically and dynamically by applying the electrical cycle as defined in figure 7. During the dynamical measurement the disc shall rotate at a speed of 60 rpm.



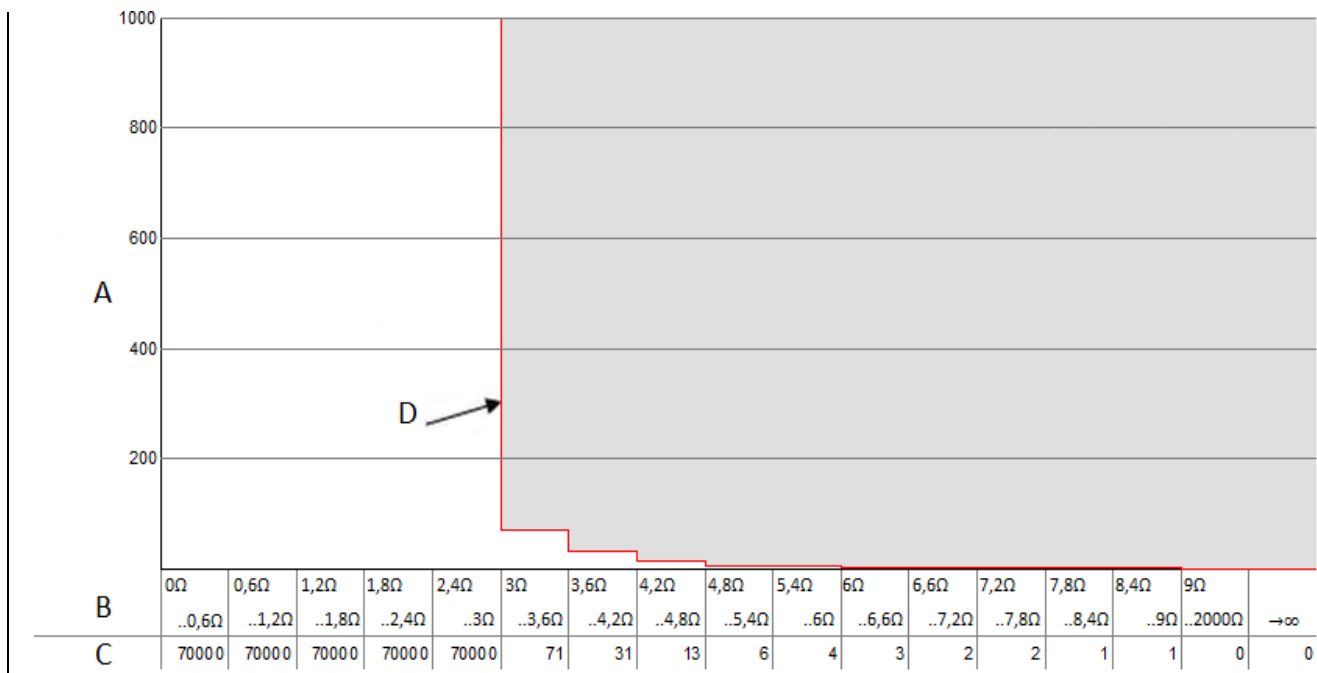

**Key**

**A** Frequency distribution of impedance per class

**B** Impedance classes

**C** Limit values of frequency distribution of impedance per class

**D** Limit curve

**Figure 8:** Limit values per impedance class for cleaned disc

The number of impedance values measured with the contaminated disc shall be lower in each impedance class than the corresponding limit values as set out in figure 9.

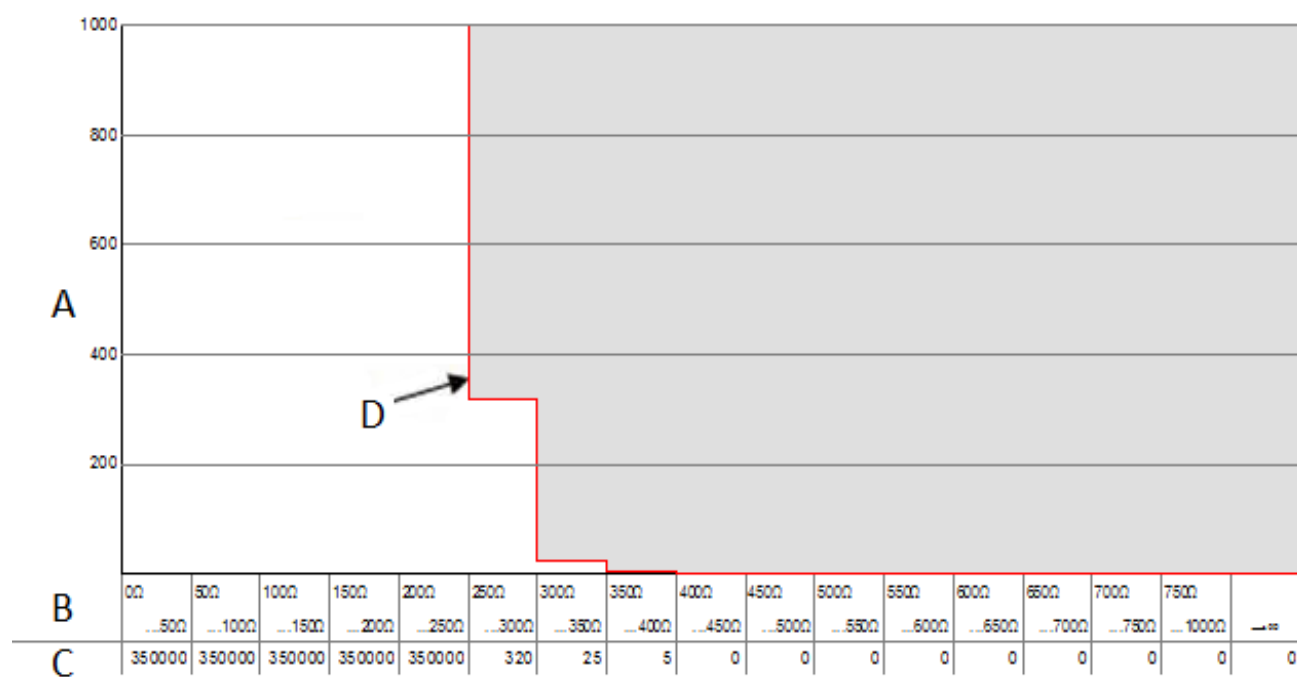

### Key

A Frequency distribution of impedance per class

B Impedance classes

C Limit values of frequency distribution of impedance per class

D Limit curve

**Figure 9:** Limit values per impedance class for contaminated disc

## **8. SUITABILITY FOR SEVERE ENVIRONMENTAL CONDITIONS**

The suitability of the friction element acting on wheel tread brakes for severe environmental conditions shall be tested in accordance with the test procedures set out in sections 8.1 or 8.2. The corresponding terms, definitions and abbreviations are explained in sections 2 and 3.

Cast iron brake blocks are deemed to be suitable for severe environmental conditions.

### **8.1 Test run**

#### **8.1.1 Test program to demonstrate the braking properties under severe environmental conditions**

The goal of this test run is to compare the results of tests without snow fly-off ('reference tests') with those with snow fly-off ('winter tests') and to determine the braking properties of friction elements acting on wheel tread brakes for severe environmental conditions under real conditions of use.

'Reference tests' and 'winter tests' shall be performed consecutively within one single period of up to 4 weeks. A running period of at least 10 min is to be observed between brake applications, with a maximum of 4 brake applications performed per hour.

The brake initiation speeds shall be

 <b>OTIF</b>	<b>ROLLING STOCK</b> <b>FREIGHT WAGONS</b>			UTP WAG 2015 Page 125 of 133
	Status: <b>PROPOSAL</b>	Version: 04	TECH-16014-CTE9-5.1b	Original: EN

- 60 km/h (for information purposes, to monitor the plausibility and comparability of the efficiency between 'reference tests' and 'winter tests'),
- if the maximum speed is 100 km/h or more: 85 % of the intended maximum speed but not more than 100 km/h, and
- 100 % of the intended maximum speed

respectively.

The tests shall be performed...

- ...with a train consisting of one locomotive and 5 wagons fulfilling the following:
  - The locomotive shall have disconnected dynamic and indirect braking.
  - The maximum dynamic mass of the locomotive shall be lower than 100 t.
  - The test wagons shall be of the same design with the same equipment and have an 'open' bogie design e.g. Y25.
  - The wheelset load when empty (without payload) shall be max. 7 t.
  - The arrangement of the friction elements shall be the one with the lowest intended specific pressure at emergency brake.
  - The emergency brake shall be applied.
  - The bedding in shall achieve a contact surface area of more than 85 %.
- ...on lines with mean gradient over the stopping distance lower than 3 ‰; maximum gradient lower than or equal to 5 ‰ and curve radii higher than or equal to 1000 m
- ...under the following environmental conditions:
  - 'Reference test': No snow fly-off (snow level 0, see figure 10) at external temperatures of up to + 5 °C.
  - 'Winter tests': During the winter semester with snow on the lines and with snow fly-off (snow level 3 to 5, see figures 11 and 12) at external temperatures between zero and -10 °C.

 <b>OTIF</b>	<b>ROLLING STOCK</b> <b>FREIGHT WAGONS</b>		<b>UTP WAG 2015</b> Page 126 of 133	
Status: <b>PROPOSAL</b>	Version: 04	TECH-16014-CTE9-5.1b	Original: EN	Date: 1.4.2016



**Figure 10:** Reference test (snow level 0)



**Figure 11:** Winter test (snow level 2 to 3)

 <b>OTIF</b>	<b>ROLLING STOCK</b> <b>FREIGHT WAGONS</b>		<b>UTP WAG 2015</b> <b>Page 127 of 133</b>	
	Status: <b>PROPOSAL</b>	Version: 04	TECH-16014-CTE9-5.1b	Original: EN



**Figure 12:** Winter test (snow level 4 to 5)

The number of 'reference tests' shall be at least 8 and maximum 20 for each brake initiation speed (60 km/h excluded) whereby the quotient of the standard deviation and the average braking distance shall not exceed 10 %.

The number of 'winter tests' shall be at least 8 (60 km/h excluded) whereby the quotient of the standard deviation and the average braking distance shall not exceed 20 % to ensure that the braking distance is representative for the assessment.

The following values shall be measured:

- Speed
- Braking distance
- Time
- Brake pipe pressure
- External temperature

### **8.1.2 Values to be determined in order to define the area of use**

The average braking distances of the 'winter tests' at each speed and the average braking distances of the 'reference tests' shall be determined.

 <b>OTIF</b>	<b>ROLLING STOCK</b> <b>FREIGHT WAGONS</b>		<b>UTP WAG 2015</b> <b>Page 128 of 133</b>	
	Status: <b>PROPOSAL</b>	Version: 04	TECH-16014-CTE9-5.1b	Original: EN

## **8.2 Dynamometer test**

### **8.2.1 Test program to demonstrate the braking properties under severe environmental conditions**

The dynamometer test program to demonstrate the extreme winter braking properties is set out in table 6 and table 7 and is only applicable if the friction element...

- ... is intended to be used in subsystems which fall under the following scope:
  - Nominal wheel diameters of 680 mm to 920 mm
  - Friction element configuration
    - 1Bg (if the test was performed in configuration 1Bg or 2Bgu)
    - 1Bgu (if the test was performed in configuration 1Bgu or 2Bgu)
    - 2Bg (if the test was performed in configuration 2Bg or 2Bgu)
    - 2Bgu (if the test was performed in configuration 2Bgu)
  - Mass per wheel  $\geq 1.8$  t
- ... complies with one of the following cases of the mean dynamic friction coefficient as determined in accordance with section 4.2 point b):

**Table 5:** Cases of the mean dynamic friction coefficient

<u>Case</u>	<u>Mean dynamic friction coefficient</u>	<u>Total <math>F_B</math> per wheel</u>	<u>Initial speed</u>
		<u><math>F_B</math></u>	<u><math>v</math></u>
		<u>[kN]</u>	<u>[km/h]</u>
<u>1</u>	<u><math>0,28 &lt; \mu_m &lt; 0,32</math></u>	<u>9</u>	<u>100</u>
<u>2</u>	<u><math>0,27 &lt; \mu_m &lt; 0,31</math></u>	<u>9</u>	<u>120</u>
<u>3</u>	<u><math>0,17 &lt; \mu_m &lt; 0,19</math></u>	<u>16</u>	<u>100</u>
<u>4</u>	<u><math>0,16 &lt; \mu_m &lt; 0,18</math></u>	<u>16</u>	<u>120</u>

To demonstrate the extreme winter braking properties of friction elements complying with cases 1 and 2 of table 5 the test program of table 6 shall be applied, for friction elements complying with cases 3 and 4 of table 5 the test program of table 7 shall be applied.

**Table 6:** Dynamometer test program – friction elements cases 1 and 2

<u>Friction element configuration</u>	<u>1Bg, 1Bgu, 2Bg or 2Bgu</u>
<u>Wheel type</u>	<u>In conformity with EN 13979-1</u>
<u>Wheel diameter</u>	<u><math>\varnothing X \pm 5</math> mm last machining size before wheel is fully worn to EN 13979-1</u>





<u>No. of brake application</u>					<u>Initial speed</u>	<u>Total F<sub>B</sub> per wheel</u>	<u>Initial temp.</u>	<u>Mass to brake per wheel</u>	<u>Remarks</u>
					<u>v</u>	<u>F<sub>B</sub></u>	<u>Θ<sub>0</sub></u>	<u>m<sub>IW</sub></u>	
					<u>[km/h]</u>	<u>[kN]</u>	<u>[°C]</u>	<u>[t]</u>	
<u>R.1 - R.X</u>					<u>100</u>	<u>12</u>	<u>20 to 100</u>	<u>7.5</u>	<u>Brake applications to rest under dry conditions to allow bedding of the friction elements up to a contact pattern of 100 % is reached</u>
<u>R.X + 1 to R.X + 20</u>					<u>100</u>	<u>12</u>	<u>20 to 100</u>	<u>2.5</u>	<u>20 brake applications to a stop (dry)</u>
<u>1 to 5</u>					<u>100</u>	<u>9</u>	<u>-5 to 60</u>	<u>2.5</u>	<u>Conditioning</u>
<u>6</u>	<u>8</u>	<u>10</u>	<u>12</u>	<u>14</u>	<u>100</u>	<u>9</u>	<u>50 to 60</u>	<u>2.5</u>	<u>Dry brake applications, warm</u>
<u>7</u>	<u>9</u>	<u>11</u>	<u>13</u>	<u>15</u>	<u>120</u>				
<u>16</u>	<u>18</u>	<u>20</u>	<u>22</u>	<u>24</u>	<u>100</u>	<u>9</u>	<u>-5 to -3</u>	<u>2.5</u>	<u>Dry brake applications, cold (reference brake applications)</u>
<u>17</u>	<u>19</u>	<u>21</u>	<u>23</u>	<u>25</u>	<u>120</u>				
									<u>Test snow machine and snow quality</u>
<u>26 to 28</u>					<u>120</u>	<u>9</u>	<u>-5 to 90</u>	<u>2.5</u>	<u>Conditioning</u>
<u>a29</u>	<u>a33</u>	<u>a37</u>	<u>a42</u>	<u>a46</u>	<u>20</u>				<u>Cooling, dry to -3 °C</u>
<u>b29</u>	<u>b33</u>	<u>b37</u>	<u>b42</u>	<u>b46</u>	<u>100</u>				<u>Rotating, dry, over 240 s</u>
<u>c29</u>	<u>c33</u>	<u>c37</u>	<u>c42</u>	<u>c46</u>	<u>100</u>				<u>Rotating, with artificial snow over 340 s</u>
<u>29</u>	<u>33</u>	<u>37</u>	<u>42</u>	<u>46</u>	<u>100</u>	<u>9</u>		<u>2.5</u>	<u>Braking with artificial snow</u>
<u>30</u>	<u>34</u>	<u>38</u>	<u>43</u>	<u>47</u>	<u>120</u>	<u>9</u>	<u>-5 to 90</u>	<u>2.5</u>	<u>Conditioning, dry</u>

**Table 6 (continued)**

<u>No. of brake application</u>					<u>Initial speed</u>	<u>Total F<sub>B</sub> per wheel</u>	<u>Initial temp.</u>	<u>Mass to brake per wheel</u>	<u>Remarks</u>
---------------------------------	--	--	--	--	----------------------	--------------------------------------	----------------------	--------------------------------	----------------

 <b>OTIF</b>	<b>ROLLING STOCK FREIGHT WAGONS</b>			UTP WAG 2015 Page 130 of 133
	Status: <b>PROPOSAL</b>	Version: 04	TECH-16014-CTE9-5.1b	Original: EN

					$v$	$F_B$	$\theta_0$	$m_w$	
					[km/h]	[kN]	[°C]	[t]	
<u>a31</u>	<u>a35</u>	<u>a39</u>	<u>a44</u>	<u>a48</u>	<u>20</u>				<u>Cooling, dry to -3 °C</u>
<u>b31</u>	<u>b35</u>	<u>b39</u>	<u>b44</u>	<u>b48</u>	<u>120</u>				<u>Rotating, dry, over 240 s</u>
<u>c31</u>	<u>c35</u>	<u>c39</u>	<u>c44</u>	<u>c48</u>	<u>120</u>				<u>Rotating with artificial snow over 900 s</u>
<u>31</u>	<u>35</u>	<u>39</u>	<u>44</u>	<u>48</u>	<u>120</u>	<u>9</u>		<u>2,5</u>	<u>Braking with artificial snow</u>
<u>32</u>	<u>36</u>	<u>40</u>	<u>45</u>	<u>49</u>	<u>120</u>	<u>9</u>	<u>-5 to 90</u>	<u>2,5</u>	<u>Conditioning, dry</u>
		<u>41</u>			<u>120</u>	<u>9</u>	<u>-5 to 90</u>	<u>2,5</u>	<u>Conditioning, dry</u>

**Table 7:** Dynamometer test program – friction elements cases 3 and 4

<u>Friction element configuration</u>	<u>1Bg, 1Bgu, 2Bg or 2Bgu</u>				
<u>Wheel type</u>	<u>In conformity with EN 13979-1</u>				
<u>Wheel diameter</u>	<u><math>\varnothing X \pm 5</math> mm last machining size before wheel is fully worn to EN 13979-1</u>				
<u>No. of brake application</u>	<u>Initial speed</u>	<u>Total <math>F_B</math> per wheel</u>	<u>Initial temp.</u>	<u>Mass to brake per wheel</u>	<u>Remarks</u>
	$v$	$F_B$	$\theta_0$	$m_{IW}$	
	[km/h]	[kN]	[°C]	[t]	
<u>R.1 - R.X</u>	<u>100</u>	<u>30</u>	<u>20 to 100</u>	<u>7,5</u>	<u>Brake applications to rest under dry conditions to allow bedding of the friction elements up to a contact pattern of 100 % is reached</u>
<u>R.X + 1 to R.X + 20</u>	<u>100</u>	<u>30</u>	<u>20 to 100</u>	<u>2,63</u>	<u>20 brake applications to a stop (dry)</u>
<u>1 to 5</u>	<u>100</u>	<u>16</u>	<u>-5 to 60</u>	<u>2,63</u>	<u>Conditioning</u>

**Table 7 (continued)**



<u>No. of brake application</u>					<u>Initial speed</u>	<u>Total <math>F_B</math> per wheel</u>	<u>Initial temp.</u>	<u>Mass to brake per wheel</u>	<u>Remarks</u>
					$v$	$F_B$	$\theta_0$	$m_w$	
					[km/h]	[kN]	[°C]	[t]	
<u>6</u>	<u>8</u>	<u>10</u>	<u>12</u>	<u>14</u>	<u>100</u>	<u>16</u>	<u>50 to 60</u>	<u>2,63</u>	<u>Dry brake applications, warm</u>
<u>7</u>	<u>9</u>	<u>11</u>	<u>13</u>	<u>15</u>	<u>120</u>			<u>2,63</u>	
<u>16</u>	<u>18</u>	<u>20</u>	<u>22</u>	<u>24</u>	<u>100</u>	<u>16</u>	<u>-5 to -3</u>	<u>2,63</u>	<u>Dry brake applications, cold (reference brake applications)</u>
<u>17</u>	<u>19</u>	<u>21</u>	<u>23</u>	<u>25</u>	<u>120</u>			<u>2,63</u>	
									<u>Test snow machine and snow quality</u>
<u>26 to 28</u>					<u>120</u>	<u>16</u>	<u>-5 to 90</u>	<u>2,63</u>	<u>Conditioning</u>
<u>a29</u>	<u>a33</u>	<u>a37</u>	<u>a42</u>	<u>a46</u>	<u>20</u>				<u>Cooling, dry to -3 °C</u>
<u>b29</u>	<u>b33</u>	<u>b37</u>	<u>b42</u>	<u>b46</u>	<u>100</u>				<u>Rotating, dry, over 240 s</u>
<u>c29</u>	<u>c33</u>	<u>c37</u>	<u>c42</u>	<u>c46</u>	<u>100</u>				<u>Rotating with artificial snow over 340 s</u>
<u>29</u>	<u>33</u>	<u>37</u>	<u>42</u>	<u>46</u>	<u>100</u>	<u>16</u>		<u>2,63</u>	<u>Braking with artificial snow</u>
<u>30</u>	<u>34</u>	<u>38</u>	<u>43</u>	<u>47</u>	<u>120</u>	<u>16</u>	<u>-5 to 90</u>	<u>2,63</u>	<u>Conditioning, dry</u>
<u>a31</u>	<u>a35</u>	<u>a39</u>	<u>a44</u>	<u>a48</u>	<u>20</u>				<u>Cooling, dry to -3 °C</u>
<u>b31</u>	<u>b35</u>	<u>b39</u>	<u>b44</u>	<u>b48</u>	<u>120</u>				<u>Rotating, dry, over 240 s</u>
<u>c31</u>	<u>c35</u>	<u>c39</u>	<u>c44</u>	<u>c48</u>	<u>120</u>				<u>Rotating with artificial snow over 900 s</u>
<u>31</u>	<u>35</u>	<u>39</u>	<u>44</u>	<u>48</u>	<u>120</u>	<u>16</u>		<u>2,63</u>	<u>Braking with artificial snow</u>
<u>32</u>	<u>36</u>	<u>40</u>	<u>45</u>	<u>49</u>	<u>120</u>	<u>16</u>	<u>-5 to 90</u>	<u>2,63</u>	<u>Conditioning, dry</u>
		<u>41</u>			<u>120</u>	<u>16</u>	<u>-5 to 90</u>	<u>2,63</u>	<u>Conditioning, dry</u>

During the tests described in tables 6 and 7 the following conditions shall be respected:

- The cooling air speed shall be as set out in table 8.

 <b>OTIF</b>	<b>ROLLING STOCK</b> <b>FREIGHT WAGONS</b>		UTP WAG 2015 Page 132 of 133	
	Status: <b>PROPOSAL</b>	Version: 04	TECH-16014-CTE9-5.1b	Original: EN

**Table 8:** Cooling air speed

	<u>Speed simulated on the test bench [km/h]</u>		<u>Speed of the cooling air [km/h]</u>	
	<u>Under dry conditions</u>	<u>With snow</u>	<u>Under dry conditions</u>	<u>With snow</u>
<u>During braking</u>	<u>v</u>	<u>v</u>	<u>25</u>	<u>25</u>
<u>Between the brake applications</u>	<u>v</u>	<u>v</u>	<u>25</u>	<u>25</u>

- The brake build-up time shall be 8 s ± 0,2 s.
- During bedding-in the following minimum numbers of brake stops shall be carried out: 40 for organic friction elements and 80 for sintered friction elements.
- All test equipment shall initially have a homogeneous temperature of -7 °C ± 2 °C. The test chamber temperature shall be -7 °C ± 2 °C. The required temperature should therefore be reached in the test chamber at least 12 h before the start of the programme (brake application n° 1).
- The snow shall be dry. Its calculated weight shall be 45 - 52 g per 250 ml measuring cup. It shall fall apart after being pressed in a palm. During the cooling periods with artificial snow and the subsequent brake applications with artificial snow, the flow of artificial snow shall not be interrupted.
- Five valid brake applications under snow (at 100 km/h and 120 km/h) are required.
- Any irregularities during testing on the friction element and the wheel contact surfaces are to be recorded and documented.
- If interruptions occur between brake applications n° 29 to 49 (e. g. due to equipment problems as a result of iced-over snow nozzles), the programme is to be continued by repeating the last conditioning brake application and the subsequent cooling operations. These interruptions are to be recorded in the test report.

### **8.2.2 Values to be determined in order to define the area of use**

The test program shall be carried out three times and the establishment of the suitability shall be done for a maximum test speed of 100 km/h and 120 km/h as follows:

- For a maximum speed of 100 km/h the deviation of the average value of the measured stopping distances  $s_1$  under snow (brake application n° 29, 33, 37, 42 and 46) from the average value of the measured stopping distances  $s_1$  under dry conditions (brake application n° 16, 18, 20, 22 and 24) shall be determined.
- For a maximum speed of 120 km/h the deviation of the average value of the measured stopping distances  $s_1$  under snow (brake application n° 31, 35, 39, 44 and 48) from the average value of the measured stopping distances  $s_1$  under dry conditions (brake application n° 17, 19, 21, 23 and 25) shall be determined.

 <b>OTIF</b>	<b>ROLLING STOCK FREIGHT WAGONS</b>			<b>UTP WAG 2015 Page 133 of 133</b>
<b>Status: PROPOSAL</b>	<b>Version: 04</b>	<b>TECH-16014-CTE9-5.1b</b>	<b>Original: EN</b>	<b>Date: 1.4.2016</b>

## **9. THERMO MECHANICAL CHARACTERISTICS**

The thermo mechanical analysis to be performed at subsystem level (freight wagon) is specified in the point 4.2.4.3.3 of the WAG TSI for the brake system and in the point 4.2.3.6.3 of the WAG TSI for the wheel, taking into account the area of use of the freight wagon.

At the interoperability constituent level (friction element for wheel tread brakes) it is allowed to take into account for the brake application No 129 of Table 1 a more demanding slope than those suggested in the column Remarks; the slope taken into account has then to be recorded in the technical documentation as part of the area of use of the friction element for wheel tread brakes.

At the interoperability constituent level (friction element for wheel tread brakes), in case the manufacturer chooses to perform the test to simulate 'locked brake' as specified in FprEN 16452:2014<sup>59</sup>, the result of this test has to be recorded in the technical documentation as part of the area of use of the friction element for wheel tread brakes.

---

<sup>59</sup> The reference will be changed to EN 16452:xxxx once this standard is published. FprEN is a stable version submitted to the formal vote within CEN-.