 <b>OTIF</b>	Uniform Technical Prescriptions <b>ACCESSIBILITY FOR PERSONS WITH DISABILITIES AND          PERSONS WITH REDUCED MOBILITY</b>			UTP PRM Page 1 of 89
	Status: <b>PROPOSAL</b>	Version: 05	Ref.: A 94-05/1.2014	Original: EN

### Amendments Record

v01	Document is prepared for WG TECH 22 (Bonn, 5.2.2014.)
v02	Version as input to WG22, taking into account draft version of the PRM TSI, submitted to RISC 69 (Document 08/57-ST27 published on CIRCABC on 10.12.2013, VERSION 2)
v03	Version including the results of WG 22. Update of scope and implementation provisions in line with the UTP LOC&PAS.
v04	English Corrected ERA comments from 28 February 2014, processed.
v05	Swiss specific cases, added as the response to OTIF Document A 94-03/501.2014 (Official letter from the Federal Office of Transport – FOT dated 24.3.2014) Linguistically edited

 <b>OTIF</b>	Uniform Technical Prescriptions <b>ACCESSIBILITY FOR PERSONS WITH DISABILITIES AND PERSONS WITH REDUCED MOBILITY</b>			UTP PRM Page 2 of 89
	Status: <b>PROPOSAL</b>	Version: 05	Ref.: A 94-05/1.2014	Original: EN

APTU Uniform Rules (Appendix F to COTIF 1999)  
**Uniform Technical Prescriptions (UTP) applicable to  
the accessibility of the rail system:**

**FOR PERSONS WITH DISABILITIES AND PERSONS WITH  
REDUCED MOBILITY - (UTP PRM)**

These regulations have been developed in accordance with the provisions of APTU, in particular Article 8, in the version as amended by the OTIF Revision Committee in 2009, which entered into force on 1 December 2010. For definitions and terms, see also Article 2 of APTU (Appendix F) and Article 2 of ATMF (Appendix G), both Appendices to the 1999 version of the COTIF Convention as applicable since 1 December 2010. Footnotes (which are not part of the regulations) include both explanatory information and references to other regulations.

*Explanatory note:*

*The texts of this UTP which appear across two columns are identical to corresponding texts of the European Union regulations. Texts which appear in two columns differ; the left-hand column contains the UTP regulations, the right-hand column shows the text in the corresponding EU regulations. The text in the right-hand column is for information only and is not part of the OTIF regulations. Texts in the right-hand column which are not quoted from the PRM TSI, but from other EU regulations are in italics.*

 <b>OTIF</b>	Uniform Technical Prescriptions <b>ACCESSIBILITY FOR PERSONS WITH DISABILITIES AND PERSONS WITH REDUCED MOBILITY</b>			UTP PRM Page 3 of 89
	Status: <b>PROPOSAL</b>	Version: 05	Ref.: A 94-05/1.2014	Original: EN

## 0. EQUIVALENCE AND TRANSITIONAL PROVISIONS

According to UTP GEN-A<sup>1</sup>, point 2.1. Infrastructure (INF), COTIF includes infrastructure only to the extent related to interfaces with the vehicles and other movable railway material. The interfaces between the rolling stock subsystem and the infrastructure subsystem covered by this UTP are limited to the gap between the platform and the vehicle entrance. The vehicle related parameters in this UTP are mandatory for admissions according to ATMF of vehicles in the scope of this UTP. The application of infrastructure related parameters, in particular those for platforms and stations, is voluntary.

## 1. INTRODUCTION

The objective of

these uniform technical prescriptions (UTP)

this technical specification for interoperability (TSI)

is to enhance the accessibility of rail transport to persons with disabilities and persons with reduced mobility.

### 1.1. TECHNICAL SCOPE

The technical scope of this

UTP shall apply to the rolling stock subsystem as defined in point 2 of UTP GEN-B<sup>2</sup> and in point 2.1 of this UTP. Its application is recommended for the infrastructure subsystem, in particular to railway stations. This UTP covers all aspects of these subsystems which are relevant to accessibility for persons with disabilities and persons with reduced mobility.

TSI is defined in Article 2(1) of the Regulation.

<sup>1</sup> Essential requirements–General Provisions, UTP, APTU (A 94-01A/1.2011)

<sup>2</sup> Subsystems– General Provisions, UTP, APTU (A 94-01B/1.2012)

 <b>OTIF</b>	Uniform Technical Prescriptions <b>ACCESSIBILITY FOR PERSONS WITH DISABILITIES AND PERSONS WITH REDUCED MOBILITY</b>			UTP PRM Page 4 of 89
	Status: <b>PROPOSAL</b>	Version: 05	Ref.: A 94-05/1.2014	Original: EN
Date: 28.03.2014				

## 1.2. GEOGRAPHICAL SCOPE

The geographical scope of this

UTP comprises all lines open to, or used for international traffic.

TSI is defined in Article 2 of the Regulation.

## 2. SCOPE OF SUBSYSTEMS AND DEFINITIONS

### 2.1. SCOPE OF THE SUBSYSTEMS

#### 2.1.1. *Scope related to Infrastructure subsystem*

The application of the UTP to stations on international lines is voluntary, but is recommended.

This TSI applies to all the public areas of stations dedicated to the transport of passengers that are controlled by the Railway Undertaking, Infrastructure Manager or Station Manager. This includes the provision of information, the purchase of a ticket and its validation if needed, and the possibility to wait for the train.

#### 2.1.2. *Scope related to Rolling Stock subsystem*

This

UTP

TSI

applies to Rolling Stock which is in the scope of the

UTP LOC&PAS

LOC&PAS TSI

and which is intended to carry passengers.

This UTP shall apply to new rolling stock which is admitted to international operation after the date of entry into force of this UTP. This is without prejudice to point 7.1.2.

(4)

*The TSI shall apply to all new infrastructure or rolling stock subsystems of the rail system in the Union, referred to in paragraph 1, which is placed in service after the date of application provided for in Article 14, account being taken of points 7.1.1 and 7.1.2 of the Annex.*

The UTP shall not apply to existing rolling stock, which is already used in international operation.

*The TSI shall not apply to existing infrastructure or rolling stock of the rail system in the Union, referred to in paragraph 1, which is already placed in service*

However, the UTP shall apply to existing rolling stock when it is subject to renewal or upgrading in accordance with Article

 <b>OTIF</b>	Uniform Technical Prescriptions <b>ACCESSIBILITY FOR PERSONS WITH DISABILITIES AND PERSONS WITH REDUCED MOBILITY</b>			UTP PRM Page 5 of 89
	Status: <b>PROPOSAL</b>	Version: 05	Ref.: A 94-05/1.2014	Original: EN

10§11 of ATMF<sup>3</sup>, having regard to the Strategy for implementation of the UTP, adopted National Implementation Plan of the Contracting States and point 7.2 of this UTP.

*on the network (or part of it) of any Member State at the date of application provided for in Article 14.*

*However, the TSI shall apply to existing infrastructure and rolling stock of the rail system in the Union, referred to in Article 2 (1), when it is subject to renewal or upgrading in accordance with Article 20 of Directive 2008/57/EC, having regard to Article 9 and 10 of this Regulation and point 7.2 of the Annex to this Regulation.*

### 2.1.3. *Scope related to operational aspects subsystem*

The responsibilities for train composition and the safe use of vehicles are set out in Appendix K to the UTP LOC&PAS. The application of this UTP to other operational aspects as described in its section 4.4 is voluntary.

This TSI applies to the procedures enabling a coherent operation of the Infrastructure and Rolling Stock subsystems when passengers are persons with disabilities and persons with reduced mobility.

### 2.1.4. *Scope related to Telematics Applications for Passengers subsystem*

This

UTP

applies to visual and audible passenger information systems located in

Rolling Stock.

TSI

stations and in

## 2.2. **DEFINITION OF "PERSON WITH DISABILITIES AND PERSON WITH REDUCED MOBILITY"**

"Person with disabilities and person with reduced mobility" means any person who has a permanent or temporary physical, mental, intellectual or sensory impairment which, in interaction with various barriers, may hinder their full and effective use of transport on an equal basis with other passengers or whose mobility when using transport is reduced due to age.

The transport of oversized items (for example: bicycles and bulky luggage) is not within the scope of this

UTP.

TSI.

<sup>4</sup> These provisions are set out in Article 2 of the Regulation enacting the PRM TSI.

<sup>3</sup> **ATMF** means the Uniform Rules concerning Technical Admission of Railway Material used in International Traffic – Appendix G to COTIF 1999 in the revised version that entered into force on 1 December 2010.

 <b>OTIF</b>	Uniform Technical Prescriptions <b>ACCESSIBILITY FOR PERSONS WITH DISABILITIES AND PERSONS WITH REDUCED MOBILITY</b>			UTP PRM Page 6 of 89
	Status: <b>PROPOSAL</b>	Version: 05	Ref.: A 94-05/1.2014	Original: EN

### 2.3. OTHER DEFINITIONS

Definitions related to rolling stock: refer to the

UTP LOC&PAS | LOC&PAS TSI

point 2.2.

#### **Obstacle-free route**

An obstacle-free route is a link between two or more public areas dedicated to the transport of passengers such as specified in point 2.1.1. It can be navigated by all persons with disabilities and reduced mobility. In order to achieve this, the route can be divided to better meet the needs of all persons with disabilities and reduced mobility. The combination of all the parts of the obstacle free route constitutes the route accessible for all persons with disabilities and reduced mobility.

#### **Step-free route**

A step-free route is a division of an obstacle-free route that meets the needs of mobility impaired persons. Changes in level are avoided or, when they cannot be avoided, they are bridged via ramps or lifts.

#### **“Tactile Signs” and “Tactile Controls”**

“Tactile signs” and “tactile controls” are signs or controls, which include raised pictograms, raised characters or Braille lettering.

#### **Station Manager**

The Station Manager is an organisational entity in a

Contracting State, | Member State,

which has been made responsible for the management of a railway station and which may be the Infrastructure Manager.

#### **Safety Information**

Safety information is information that shall be given to passengers so that they know in advance how they have to behave in case of an emergency.

#### **Safety Instructions**

Safety instructions are the instructions that shall be given to passengers in case of an emergency so that they understand what to do.

#### **Level access**

A level access is an access from a platform to the doorway of a rolling stock for which it can be demonstrated that:

- The gap between the door sill of that doorway (or of the extended bridging plate of that doorway) and the platform does not exceed 75 mm measured horizontally and 50 mm measured vertically and
- The rolling stock has no internal step between the door sill and the vestibule.

 <b>OTIF</b>	Uniform Technical Prescriptions <b>ACCESSIBILITY FOR PERSONS WITH DISABILITIES AND PERSONS WITH REDUCED MOBILITY</b>			UTP PRM Page 7 of 89
	Status: <b>PROPOSAL</b>	Version: 05	Ref.: A 94-05/1.2014	Original: EN

### 3. ESSENTIAL REQUIREMENTS

The following tables indicate the essential requirements, as set out in

UTP GEN-A | Annex III of Directive 2008/57/EC<sup>5</sup>

that are met by the specifications set out in Section 4 of this

UTP | TSI

for the scope of this

UTP. | TSI.

The essential requirements that are not listed in the table are not relevant within the scope of this

UTP. | TSI.

Infrastructure		Reference to Essential Requirement in UTP GEN-A / Annex III to Directive 2008/57/EC					
Element of the UTP / TSI Domain	Reference point of this UTP / Annex	Safety	Reliability and Availability	Health	Environmental protection	Technical compatibility	Accessibility <sup>6</sup>
		Parking facilities for persons with disabilities and persons with reduced mobility	4.2.1.1				
Obstacle-free route	4.2.1.2	2.1.1					2.1.2
Doors and entrances	4.2.1.3	1.1.1 2.1.1					2.1.2
Floor surfaces	4.2.1.4	2.1.1					2.1.2
Highlighting of transparent obstacles	4.2.1.5	2.1.1					2.1.2
Toilets and baby-nappy changing facilities	4.2.1.6	1.1.5 2.1.1					2.1.2
Furniture and free-standing devices	4.2.1.7	2.1.1					2.1.2
Ticketing, information desks and customer assistance points	4.2.1.8	2.1.1	2.7.3			2.7.1	2.1.2 2.7.5
Lighting	4.2.1.9	2.1.1					2.1.2

<sup>5</sup> Directive 2008/57/EC of the European Parliament and of the Council of 17 June 2008 on the interoperability of the rail system within the Community (OJ L 191, 18.07.2008, p.1.)

<sup>6</sup> Essential Requirement from Commission Directive 2013/9/EU of 11 March 2013 amending Annex III to Directive 2008/57/EC (OJ L 68 12.3.2013. p.55)

 <b>OTIF</b>	Uniform Technical Prescriptions <b>ACCESSIBILITY FOR PERSONS WITH DISABILITIES AND PERSONS WITH REDUCED MOBILITY</b>			UTP PRM Page 8 of 89
	Status: <b>PROPOSAL</b>	Version: 05	Ref.: A 94-05/1.2014	Original: EN
Date: 28.03.2014				

<b>Infrastructure</b>		<b>Reference to Essential Requirement in UTP GEN-A / Annex III to Directive 2008/57/EC</b>					
<b>Element of the UTP / TSI Domain</b>	<b>Reference point of this UTP / Annex</b>	<b>Safety</b>	<b>Reliability and Availability</b>	<b>Health</b>	<b>Environ-mental protection</b>	<b>Technical compatibility</b>	<b>Accessibility<sup>6</sup></b>
Visual information: signposting, pictograms, printed or dynamic information	4.2.1.10					2.7.1	2.1.2 2.7.5
Spoken information	4.2.1.11	2.1.1	2.7.3			2.7.1	2.1.2 2.7.5
Platform width and edge of platform	4.2.1.12	2.1.1					2.1.2
End of platform	4.2.1.13	2.1.1					2.1.2
Boarding aids on platforms	4.2.1.14	1.1.1					2.1.2
Level track crossing at stations	4.2.1.15	2.1.1					2.1.2

Table 1: Essential requirements for the Infrastructure subsystem

<b>Rolling Stock</b>		<b>Reference to Essential Requirement in UTP GEN-A / Annex III of Directive 2008/57/EC</b>					
<b>Element of the UTP / TSI Domain</b>	<b>Reference point of this UTP / Annex</b>	<b>Safety</b>	<b>Reliability and Availability</b>	<b>Health</b>	<b>Environ-mental protection</b>	<b>Technical compatibility</b>	<b>Accessibility</b>
Seats	4.2.2.1			1.3.1			2.4.5
Wheelchair spaces	4.2.2.2	2.4.1					2.4.5
Doors	4.2.2.3	1.1.1 1.1.5 2.4.1	1.2				2.4.5
Lighting	4.2.2.4	2.4.1					2.4.5
Toilets	4.2.2.5	2.4.1					2.4.5
Clearways	4.2.2.6			1.3.1			2.4.5
Customer information	4.2.2.7	2.4.1	2.7.3			2.7.1	2.4.5 2.7.5
Height changes	4.2.2.8	1.1.5					2.4.5
Handrails	4.2.2.9	1.1.5					2.4.5
Wheelchair accessible sleeping accommodation	4.2.2.10	2.4.1					2.4.5
Step position for vehicle access and egress	4.2.2.11	1.1.1	2.4.2			1.5 2.4.3	2.4.5
Boarding aids	4.2.2.12	1.1.1				1.5 2.4.3	2.4.5

Table 2: essential requirements for the Rolling Stock subsystem



 <b>OTIF</b>	Uniform Technical Prescriptions <b>ACCESSIBILITY FOR PERSONS WITH DISABILITIES AND PERSONS WITH REDUCED MOBILITY</b>			UTP PRM Page 9 of 89
	Status: <b>PROPOSAL</b>	Version: 05	Ref.: A 94-05/1.2014	Original: EN

## 4. CHARACTERISATION OF THE SUBSYSTEMS

### 4.1. INTRODUCTION

#### 1) The rail system

to which APTU<sup>7</sup> and ATMF apply is defined by means of subsystems as set out in UTP GEN-B. The consistency between the different subsystems

of the Union, to which Directive 2008/57/EC applies and of which the subsystems are parts, is an integrated system whose consistency

shall be verified. This consistency shall be checked in particular with regard to the specifications of each subsystem, its interfaces vis-à-vis the system in which it is integrated as well as the operating and maintenance rules.

#### 2) The functional and technical specifications of the subsystems and their interfaces, described in points 4.2 and 4.3, do not impose the use of specific technologies or technical solutions, except where this is strictly necessary for the interoperability of the

Union

rail network. But innovative solutions for interoperability may require new specifications and/or new assessment methods. In order to allow technological innovation, these specifications and assessment methods shall be developed by the process described

below.

in Article 6 of the Regulation.

In order to keep pace with technological progress, innovative solutions may be required, which do not comply with the specifications set out in this UTP and/or for which the assessment methods set out in this UTP cannot be applied. In that case, new specifications and/or new assessment methods associated with these innovative solutions shall be developed.

(<sup>8</sup>)

*Technological progress may require innovative solutions, which do not comply with the specifications set out in the Annex or for which the assessment methods set out in the Annex cannot be applied.*

Innovative solutions may be related to the rolling stock subsystem, its parts and its ICs.

1. *Innovative solutions may concern the infrastructure and rolling stock subsystems, their parts and their interoperability constituents.*

If an innovative solution is proposed, the manufacturer or his authorised representative shall declare how it deviates from or complements the relevant provisions of this UTP and shall submit the

2. *If an innovative solution is proposed, the manufacturer or his authorised representative established within the Union shall state how it deviates from the relevant provision of the TSI set out in the Annex and submit it to the Commission for*

<sup>7</sup> **APTU** means the Uniform Rules concerning the Validation of Technical Standards and the Adoption of Uniform Technical Prescriptions applicable to Railway Material intended to be used in International Traffic—Appendix F to COTIF 1999 in the revised version that entered into force on 1 December 2010.

<sup>8</sup> These provisions are set out in Article 6 of the Regulation enacting the PRM TSI

 <b>OTIF</b>	Uniform Technical Prescriptions <b>ACCESSIBILITY FOR PERSONS WITH DISABILITIES AND PERSONS WITH REDUCED MOBILITY</b>			UTP PRM Page 10 of 89
	Status: <b>PROPOSAL</b>	Version: 05	Ref.: A 94-05/1.2014	Original: EN

deviations to the Secretary General for analysis. The Secretary General will coordinate its opinion on the proposed innovative solution with the EU and the European Railway Agency (the Agency) and present its opinion to the CTE.

If the CTE supports the opinion, the appropriate functional and interface specifications and the assessment method, which need to be included in the UTP in order to allow the use of this innovative solution, shall be developed in coordination with the EU and subsequently integrated in the UTP during their respective revision processes.

Pending the revision of the UTP, the positive CTE opinion shall be considered as acceptable means of compliance with the essential requirements of UTP GEN-A and may therefore be used for the assessment of the subsystem.

*analysis. The Commission may request the Agency's opinion on the proposed innovative solution and, where appropriate, may consult relevant stakeholders.*

3. *The Commission shall deliver an opinion on the proposed innovative solution. If this opinion is positive, the appropriate functional and interface specifications and the assessment method needed in the TSI to enable use to be made of this innovative solution shall be developed and subsequently incorporated in the TSI during the revision process. If the opinion is negative, the innovative solution proposed cannot be applied.*

4. *Pending the revision of the TSI, the positive opinion delivered by the Commission shall be considered as acceptable means of compliance with the essential requirements of Directive 2008/57/EC and may be used for the assessment of subsystems and projects.*

3) Taking account of all the applicable essential requirements, the basic parameters related to accessibility for persons with disabilities and persons with reduced mobility are set out for the subsystems infrastructure and rolling stock in point 4.2 of this

UTP.

The operational requirements and responsibilities are

deemed to be set out at national level, in compliance with any applicable OTIF regulation and in accordance with the provision set out

in point 4.4 of this

UTP.

TSI.

set out in the OPE TSI and

TSI.

## 4.2. FUNCTIONAL AND TECHNICAL SPECIFICATIONS

### 4.2.1. Infrastructure Subsystem

1) In light of the essential requirements in Section 3, the functional and technical specifications of the infrastructure subsystem related to accessibility for persons with disabilities and persons with reduced mobility are arranged as follows:

- Parking facilities for persons with disabilities and persons with reduced mobility
- Obstacle-free routes

 <b>OTIF</b>	Uniform Technical Prescriptions <b>ACCESSIBILITY FOR PERSONS WITH DISABILITIES AND PERSONS WITH REDUCED MOBILITY</b>			UTP PRM Page 11 of 89
	Status: <b>PROPOSAL</b>	Version: 05	Ref.: A 94-05/1.2014	Original: EN

- Doors and entrances
- Floor surfaces
- Highlighting of transparent obstacles
- Toilets and baby nappy changing facilities
- Furniture and free-standing devices
- Ticketing, information desks and customer assistance points
- Lighting
- Visual information: signposting, pictograms, printed or dynamic information
- Spoken information
- Platform width and edges of platforms
- End of platforms
- Boarding aids stored on platforms
- Level track crossings

2) The basic parameters that are specified in points 4.2.1.1 – 4.2.1.15 apply to the scope of the infrastructure subsystem that is defined in point 2.1.1; they can be divided into two categories:

- Those for which technical details need to be specified, such as the parameters relative to the platforms and how to reach the platforms. In this first case, the basic parameters are specifically described and the technical details to be satisfied in order to fulfil the requirement are detailed.
- Those for which technical details are not necessary to be specified, such as the value of ramps or the characteristics of parking places. In this second case, the basic parameter is defined as a functional requirement that can be met by applying several technical solutions.

The table 3 below indicates the category of each of the basic parameters.

Basic Parameter	Technical details provided	Functional requirement only
Parking facilities for persons with disabilities and persons with reduced mobility		Complete point 4.2.1.1
Obstacle-free route	Location of the routes Width of the obstacle-free route Threshold Double handrails Type of lift Height of braille signs	Detailed characteristics
Doors and entrances	4.2.1.3 (2): Door width 4.2.1.3 (4): Height of door operating device	4.2.1.3 (1) 4.2.1.3 (3)
Floor surfaces		Complete point 4.2.1.4
Highlighting of Transparent obstacles		Complete point 4.2.1.5
Toilets and baby nappy changing facilities		Complete point 4.2.1.6
Furniture and free-standing		Complete point 4.2.1.7

 <b>OTIF</b>	Uniform Technical Prescriptions <b>ACCESSIBILITY FOR PERSONS WITH DISABILITIES AND PERSONS WITH REDUCED MOBILITY</b>			UTP PRM Page 12 of 89
	Status: <b>PROPOSAL</b>	Version: 05	Ref.: A 94-05/1.2014	Original: EN

devices		
Ticketing, Information desks and Customer Assistance points	4.2.1.8 (5): Passageway for ticket control machines	4.2.1.8 (1) – (4) 4.2.1.8 (6)
Lighting	4.2.1.9 (3): Lighting on platforms	4.2.1.9 (1), 4.2.1.9 (2), 4.2.1.9 (4): Lighting in other locations
Visual information: signposting, pictograms, printed or dynamic information	Detail of information to be provided Location of information	Detailed characteristics of visual information
Spoken information	Complete point 4.2.1.11	
Platform width and edge of platform	Complete point 4.2.1.12	
End of platform	Complete point 4.2.1.13	
Boarding aids stored on platforms	Complete point 4.2.1.14	
Passenger track level crossing at stations	Complete point 4.2.1.15	

Table 3: categories of basic parameters

#### 4.2.1.1. Parking facilities for persons with disabilities and persons with reduced mobility

- 1) Where a station specific parking area exists, there shall be sufficient and adapted parking spaces reserved for persons with disabilities and persons with reduced mobility eligible to utilise them at the nearest practicable position, within the parking area, to an accessible entrance.

#### 4.2.1.2. Obstacle-free route

- 1) Obstacle free routes shall be provided that interconnect the following public areas of the infrastructure if provided:
  - Stopping points for other connecting modes of transport within the station confines (for example, taxi, bus, tram, metro, ferry etc.);
  - Car parks
  - Accessible entrances and exits
  - Information desks
  - Visual and audible information systems
  - Ticketing facilities
  - Customer assistance
  - Waiting areas
  - Toilet facilities
  - Platforms
- 2) The length of the obstacle-free routes shall be the shortest practical distance.
- 3) Obstacle-free route floor surfaces and ground surfaces shall have low reflecting properties.

 <b>OTIF</b>	Uniform Technical Prescriptions <b>ACCESSIBILITY FOR PERSONS WITH DISABILITIES AND PERSONS WITH REDUCED MOBILITY</b>			UTP PRM Page 13 of 89
	Status: <b>PROPOSAL</b>	Version: 05	Ref.: A 94-05/1.2014	Original: EN

#### 4.2.1.2.1 Horizontal circulation

- 1) All obstacle-free routes, footbridges and subways, shall have a free width of a minimum of 160cm except in areas that are specified in points 4.2.1.3 (2) (doors), 4.2.1.12 (3) (platforms) and 4.2.1.15 (2) (level crossings).
- 2) Where thresholds are installed on a horizontal route, they shall contrast with the surrounding floor and shall not be higher than 2.5cm.

#### 4.2.1.2.2 Vertical circulation

- 1) Where an obstacle-free route includes a change in level, there shall be a step-free route providing an alternative to stairs for mobility impaired people.
- 2) Staircases on the obstacle-free routes shall have a minimum width of 160cm measured between the handrails. As a minimum the first and last steps shall be indicated by a contrasting band and as a minimum tactile warning surface indicators shall be installed before the first descending step.
- 3) Ramps shall be installed for persons with disabilities and persons with reduced mobility unable to use stairs where lifts are not provided. They shall have a moderate gradient. A steep gradient is allowed for ramps on short distances only.
- 4) Stairs and ramps shall be provided with handrails on both sides and at two levels.
- 5) Lifts shall be provided where ramps are not available and shall be at least of type 2 in accordance with the specification referenced in Appendix A, index 1. Type 1 lifts are allowed in the case of stations being renewed or upgraded only.
- 6) Escalators and moving walks shall be designed in accordance with the specification referenced in Appendix A, index 2.
- 7) Level track crossings can form part of an obstacle-free route when they comply with the requirements of point 4.2.1.15.

#### 4.2.1.2.3 Route identification

- 1) Obstacle-free routes shall be clearly identified by visual information as detailed in point 4.2.1.10.
- 2) Information on the obstacle-free route shall be given to visually impaired people by tactile and contrasting walking surface indicators as a minimum. This paragraph does not apply to obstacle free routes to and from car parks.
- 3) Technical solutions using remotely controlled audible devices or telephone applications are permitted to be used in addition or as an alternative. When they are intended to be used as an alternative, they shall be treated as innovative solutions.
- 4) If there are handrails or walls within reach along the obstacle-free route to the platform, they shall have brief information (for example platform-number or direction-information) in Braille or in prismatic-letters or numbers on the handrail, or on the wall at a height between 145cm and 165cm.

#### 4.2.1.3. Doors and entrances

- 1) This point applies to all doors and entrances that are on obstacle-free routes, with the exception of doors giving access to the toilets which are not dedicated to persons with disabilities and persons with reduced mobility.

 <b>OTIF</b>	Uniform Technical Prescriptions <b>ACCESSIBILITY FOR PERSONS WITH DISABILITIES AND PERSONS WITH REDUCED MOBILITY</b>			UTP PRM Page 14 of 89
	Status: <b>PROPOSAL</b>	Version: 05	Ref.: A 94-05/1.2014	Original: EN
				Date: 28.03.2014

- 2) Doors shall have a minimum clear useable width of 90cm and shall be operable by persons with disabilities and persons with reduced mobility.
- 3) It is permitted to use manual, semi-automatic or automatic doors.
- 4) Door operating devices shall be available at a height of between 80cm and 110cm.

#### 4.2.1.4. Floor surfaces

- 1) All floor coverings, ground surfaces and stair tread surfaces shall be slip resistant.
- 2) Within the station buildings there shall be no irregularities in excess of 0.5cm at any given point in floor walking surface areas, except for thresholds, drainage channels and tactile walking surface indicators.

#### 4.2.1.5. Highlighting of Transparent obstacles

- 1) Transparent obstacles on or along the routes used by passengers, consisting of glass doors or transparent walls, shall be marked. These markings shall highlight the transparent obstacles. They are not required if passengers are protected from impact by other means – for example, by handrails or continuous benches.

#### 4.2.1.6. Toilets and baby nappy changing facilities

- 1) If toilets are provided at a station, then a minimum of one unisex cubicle shall be wheelchair accessible.
- 2) If toilets are provided at a station, baby nappy changing facilities shall be provided which are accessible to both men and women

#### 4.2.1.7. Furniture and free-standing devices

- 1) All items of furniture and free-standing devices at stations shall contrast with their background, and have rounded edges.
- 2) Within the station confines, furniture and free-standing devices (including cantilevered and suspended items) shall be positioned where they do not obstruct blind or visually impaired people, or they shall be detectable by a person using a long cane.
- 3) On each platform where passengers are allowed to wait for trains, and at every waiting area, there shall be a minimum of one area fitted with seating facilities and a space for a wheelchair.
- 4) When this area is weather protected, it shall be accessible by a wheelchair user.

#### 4.2.1.8. Ticketing, Information desks and Customer Assistance points

- 1) Where manual ticket sales counters, information desks and customer assistance points are provided along the obstacle-free route, a minimum of one desk shall be accessible to a wheelchair user and to people of small stature and a minimum of one desk shall be fitted with an induction loop system for hearing assistance.

 <b>OTIF</b>	Uniform Technical Prescriptions <b>ACCESSIBILITY FOR PERSONS WITH DISABILITIES AND PERSONS WITH REDUCED MOBILITY</b>			UTP PRM Page 15 of 89
	Status: <b>PROPOSAL</b>	Version: 05	Ref.: A 94-05/1.2014	Original: EN

- 2) If there is a glass barrier between the passenger and sales person at the ticket counter, this shall either be removable or, if not removable, an intercom system shall be fitted. Any such glass barrier shall consist of clear glass.
- 3) If electronic devices are fitted that displays pricing information to the sales person, such devices shall also be fitted that display the price to the person purchasing the ticket.
- 4) Where ticket vending machines are provided on an obstacle free route at a station, a minimum of one of these machines shall have an interface that is reachable by a wheelchair user and people of small stature.
- 5) If ticket control machines are fitted, a minimum of one of the machines shall have a free passageway with a minimum width of 90cm and shall be able to accommodate an occupied wheelchair up to 1250mm in length. In the case of upgrade or renewal, a minimum width of 80cm is permitted.
- 6) If turnstiles are used, there shall be a non-turnstile access point available for use by persons with disabilities and persons with reduced mobility at all operational times.

#### 4.2.1.9. Lighting

- 1) The illuminance level of the external areas of the station shall be sufficient to facilitate way finding and to highlight the changes of level, doors and entrances.
- 2) The illuminance level along obstacle-free routes shall be adapted to the visual task of the passenger. Particular attention shall be paid to the changes of levels, ticket vending offices and machines, information desks and information displays.
- 3) The platforms shall be illuminated according the specification referenced in Appendix A, index 3 and index 4.
- 4) Emergency lighting shall provide sufficient visibility for evacuation and for identification of fire-fighting and safety equipment.

#### 4.2.1.10. Visual information: signposting, pictograms, printed or dynamic information

- 1) The following information shall be provided:
  - Safety Information and Safety Instructions.
  - Warning, prohibition and mandatory actions signs.
  - Information concerning the departure of trains.
  - Identification of station facilities, where provided, and access routes to those facilities.
- 2) The fonts, symbols and pictograms used for visual information shall contrast with their background.
- 3) Signposting shall be provided at all points where passengers need to make a route taking decision and at intervals on the route. Signage, symbols and pictograms shall be applied consistently over the whole route.
- 4) The information concerning the departure of trains (including destination, intermediate stops, platform number and time) shall be available at a height of 160cm maximum at least in one location in the station. This requirement applies to printed and dynamic information whatever is provided.

 <b>OTIF</b>	Uniform Technical Prescriptions <b>ACCESSIBILITY FOR PERSONS WITH DISABILITIES AND PERSONS WITH REDUCED MOBILITY</b>			UTP PRM Page 16 of 89
	Status: <b>PROPOSAL</b>	Version: 05	Ref.: A 94-05/1.2014	Original: EN

- 5) The typeface used for texts shall be easily readable.
- 6) All safety, warning, mandatory action and prohibition signs shall include pictograms.
- 7) Tactile information signage shall be fitted in:
  - Toilets, for functional information and call for aid if appropriate
  - Lifts in accordance with the specification referenced in Appendix A, index 1.
- 8) Time information presented in digits shall be in the 24h system
- 9) The following specific graphic symbols and pictograms shall be fitted with the wheelchair symbol in accordance with appendix N:
  - Directional information for wheelchair specific routes
  - Indication of the wheelchair accessible toilets and other amenities if provided
  - If there is train configuration information on the platform, indication of the wheelchair boarding location.

The symbols are permitted to be combined with other symbols (for example: lift, toilet, etc).
- 10) Where inductive loops are fitted these shall be indicated by a sign as described in appendix N.
- 11) In wheelchair accessible toilets, where hinged handrails are provided, a graphic symbol showing the rail in both the stowed and deployed position shall be provided.
- 12) There shall be no more than five pictograms, together with a directional arrow, indicating a single direction placed adjacent to each other at a single location.
- 13) Displays shall be compliant to the requirements of point 5.3.1.1. In this point, the term “display” shall be understood as any support of dynamic information.

#### 4.2.1.11. Spoken information

- 1) The spoken information shall have a minimum STI-PA level of 0.45, in accordance with the specification referenced in Appendix A, index 5.

#### 4.2.1.12. Platform width and edge of platform

- 1) The danger area of a platform commences at the rail side edge of the platform and is defined as the area where passengers are not allowed to stand when trains are passing or arriving.
- 2) It is permitted for the width of the platform to be variable on the whole length of the platform.
- 3) The minimum width of the platform without obstacles shall be the width of the danger area plus the width of two opposing freeways of 80cm (160cm). This dimension may taper to 90cm at the platform ends.
- 4) It is permitted to have obstacles inside this freeway of 160cm. Equipment required for the signalling system and safety equipment shall not be considered as obstacles in this point. The minimum distance from obstacles to the danger area shall be according to the following table:

Length of obstacles (measured parallel to the platform edge)	Minimum distance to the danger area
---	-------------------------------------



 <b>OTIF</b>	Uniform Technical Prescriptions <b>ACCESSIBILITY FOR PERSONS WITH DISABILITIES AND PERSONS WITH REDUCED MOBILITY</b>			UTP PRM Page 17 of 89
	Status: <b>PROPOSAL</b>	Version: 05	Ref.: A 94-05/1.2014	Original: EN

< 1m (note 1) – small obstacle	80cm
1m to < 10m – large obstacle	120cm

Table 4: minimum distance from obstacles to the danger area

Note 1: if the distance between two small obstacles is less than 2.4m measured parallel to the platform edge they shall be considered as one large obstacle.

Note 2: Within this minimum distance from a large obstacle to the danger area it is permitted to have additional small obstacles as long as the requirements for small obstacles (minimum distance to danger area and minimum distance to next small obstacle) are met.

- 5) If there are auxiliary facilities on-board trains, or on the platform, to allow wheelchair users to board on or alight from trains, a free space (no obstacles) of 150cm from the edge of the facility towards the direction where the wheelchair boards,/lands at/to the platform level, shall be provided where such facilities are likely to be used. A new station shall meet this requirement for all trains that are planned to stop at the platform.
- 6) The boundary of the danger area, furthest from the rail side edge of the platform, shall have a visual marking and tactile walking surface indicators.
- 7) The visual marking shall be a contrasting, slip resistant, warning line with a minimum width of 10cm.
- 8) Tactile walking surface indicators can be one of the two types:
  - an attention pattern indicating a hazard at the boundary of the danger area
  - a guiding pattern indicating a path of travel at the safe side of the platform
- 9) The material at the rail side edge of the platform shall contrast with the darkness of the gap.

#### 4.2.1.13. End of platform

- 1) The end of the platform shall either be fitted with a barrier that prevents public access or shall have a visual marking and tactile walking surface indicators with an attention pattern indicating a hazard.

#### 4.2.1.14. Boarding aids stored on platforms

- 1) If a platform ramp is used, it shall comply with the requirements of point 5.3.1.2.
- 2) If a platform lift is used, it shall comply with the requirements of point 5.3.1.3.
- 3) A secure storage method shall be provided to ensure that boarding aids, including portable ramps, when stored on a platform, do not cause an obstruction or pose any hazard to passengers.

#### 4.2.1.15. Passenger track crossing to platforms

- 1) Level track crossings in stations are permitted to be used as part of a step-free route or of an obstacle-free route according to National Rules.
- 2) If level track crossings are used as parts of step free routes in addition to other routes, they shall:
  - have a minimum width of 120cm (less than 10 m in length) or 160cm (10 m or more in length).

 <b>OTIF</b>	Uniform Technical Prescriptions <b>ACCESSIBILITY FOR PERSONS WITH DISABILITIES AND PERSONS WITH REDUCED MOBILITY</b>			UTP PRM Page 18 of 89
	Status: <b>PROPOSAL</b>	Version: 05	Ref.: A 94-05/1.2014	Original: EN

- have moderate slopes; a steep gradient is only allowed for ramps on short distances
  - be designed so that the smallest wheel of a wheelchair, as defined in appendix M, cannot be trapped within the crossing surface and the rail
  - where accesses to level crossings are equipped with safety chicanes in order to prevent people from unintended/uncontrolled crossing of the tracks, the minimum width of the walkways in the straight line and in the chicane can be less than 120cm with a minimum of 90cm; it shall be sufficient for a wheelchair user to manoeuvre.
- 3) If level track crossings are used as parts of obstacles free routes, unique solution for all passengers, they shall
- meet all specifications above,
  - have visual and tactile markings to identify the beginning and the end of the crossing surface.
  - be supervised, or, on the basis of national rules, equipment for a safe crossing of blind or visually impaired people shall be provided and/or the level crossing shall be operated for a safe crossing of visually impaired people
- 4) If any of the above requirements cannot be met, the level track crossing shall not be considered part of a step-free route or of an obstacle-free route.

#### 4.2.2. *Rolling Stock Subsystem*

- 1) In light of the essential requirements in Section 3, the functional and technical specifications of the subsystem Rolling Stock related to accessibility for persons with disabilities and persons with reduced mobility are arranged as follows:
- Seats
  - Wheelchair spaces
  - Doors
  - Lighting
  - Toilets
  - Clearways
  - Customer information
  - Height changes
  - Handrails
  - Wheelchair accessible sleeping accommodation
  - Step position for vehicle access and egress

##### 4.2.2.1. Seats

###### 4.2.2.1.1 General

- 1) Handholds or vertical handrails or other items that can be used for personal stability, whilst using the aisle, shall be provided on all aisle-side seats unless the seat, when in the upright position, is within 200mm of:

 <b>OTIF</b>	Uniform Technical Prescriptions <b>ACCESSIBILITY FOR PERSONS WITH DISABILITIES AND PERSONS WITH REDUCED MOBILITY</b>			UTP PRM Page 19 of 89
	Status: <b>PROPOSAL</b>	Version: 05	Ref.: A 94-05/1.2014	Original: EN

- the back of another seat facing in the opposite direction which is fitted with a handhold or a vertical handrail or other items that can be used for personal stability
  - a handrail or a partition.
- 2) Handholds or other items that can be used for personal stability shall be positioned at a height of between 800mm and 1200mm above the floor, measured from the centre of the usable part of the handhold, shall not protrude into the clearway and shall contrast with the seat.
  - 3) In seating areas with fixed longitudinal seats, handrails shall be used for personal stability. These handrails shall be at a maximum distance of 2000mm apart, shall be positioned at a height of between 800mm and 1200mm above the floor and shall contrast with the vehicle interior surroundings.
  - 4) The handholds or other items shall not have sharp edges.

#### 4.2.2.1.2 Priority seats

##### 4.2.2.1.2.1 General

- 1) Not less than 10 percent of the seats by fixed trainset or individual vehicle, and by class shall be designated as priority seats for the use of persons with disabilities and persons with reduced mobility.
- 2) The priority seats and vehicles containing them shall be identified by signs complying with appendix N. It shall be stated that other passengers shall make such seats available to those who are eligible to use them when required.
- 3) The priority seats shall be located within the passenger saloon and in close proximity to external doors. In double deck vehicles or trainsets, priority seats can be present on both decks.
- 4) The level of equipment fitted to the priority seats shall, as a minimum, be the same as that fitted to general seats of the same type.
- 5) When seats of a certain type are fitted with armrests, priority seats of the same type shall be fitted with movable armrests, this excludes armrests placed along the vehicle body side or along a partition wall in case of compartments. The movable armrest shall move into a position in line with the seat back cushion to enable unrestricted access to the seat or to any adjacent priority seats.
- 6) Priority seats shall not be tip-up seats.
- 7) Each priority seat and the space available to its user shall comply with the figures H1 to H4 from Appendix H.
- 8) The whole useful sitting surface of the priority seat shall be a minimum of 450mm wide (see figure H1).
- 9) The top of each priority seat cushion shall be between 430 and 500mm above floor level at the front edge of the seat.
- 10) The clear headroom above each seat shall be at least 1680mm from floor level, except on double-decker trains on which luggage racks are provided above the seats. In such case reduced headroom of 1520mm is permitted for priority seats underneath the luggage racks, provided that at least 50% of priority seats maintain headroom of 1680mm.
- 11) Where reclining seats are fitted, the dimensions shall be measured when the seats are in their fully upright position.

 <b>OTIF</b>	Uniform Technical Prescriptions <b>ACCESSIBILITY FOR PERSONS WITH DISABILITIES AND PERSONS WITH REDUCED MOBILITY</b>			UTP PRM Page 20 of 89
	Status: <b>PROPOSAL</b>	Version: 05	Ref.: A 94-05/1.2014	Original: EN

#### 4.2.2.1.2.2 Uni-directional seats

- 1) Where uni-directional priority seats are provided, the clearance in front of each seat shall comply with figure H2.
- 2) The distance between the front surface of the seat back and the vertical plane through the rearmost part of the seat in front shall be a minimum of 680mm, noting that the required seat pitch shall be measured from the centre of the seat 70mm above where the cushion meets the back support.
- 3) There shall also be a clear space between the front edge of the seat cushion and the same vertical plane for the seat in front of a minimum of 230mm.

#### 4.2.2.1.2.3 Facing seats arrangement

- 1) Where facing priority seats are provided, the distance between the front edges of the seat cushions shall be a minimum of 600mm (See figure H3). Such distance shall be maintained even if one of the facing seats is not a priority seat.
- 2) Where facing priority seats are equipped with a table, there shall be a minimum clear horizontal distance between the front edge of the seat cushion and the leading edge of the table of at least 230mm (See figure H4). When one of the facing seats is not a priority seat, its distance to the table can be reduced provided that the distance between the front edges of the seat cushions remains 600mm. Sidewall mounted tables which length does not extend over the centre line of the window seat do not need to be considered for conformity with this paragraph.

#### 4.2.2.2. Wheelchair spaces

- 1) According to the length of the unit, excluding the locomotive or power head, there shall be in that unit not less than the number of accessible wheelchair spaces shown in the following table:

<b>Unit length</b>	<b>Number of wheelchair spaces by unit</b>
Less than 30 m	1 wheelchair space
30 to 205 metres	2 wheelchair spaces
More than 205 to 300 metres	3 wheelchair spaces
More than 300 metres	4 wheelchair spaces

Table 5: minimum number of wheelchair spaces per unit length

- 2) To ensure stability, the wheelchair space shall be designed for the wheelchair to be positioned either facing or back to the direction of travel.
- 3) Over the full length of the wheelchair space the width shall be 700mm from floor level to a minimum height of 1450mm with an additional 50mm width to give clearance for hands on each side that is adjacent to any obstacle that will inhibit clearance for the wheelchair users hands (e.g. wall or structure) from a height of 400mm to 800mm above floor level (if one side of the wheelchair is adjacent to the aisle there is no additional 50mm requirement for that side of the wheelchair as it is already free space)
- 4) The minimum distance in the longitudinal plane between the back of the wheelchair space and the next surface shall be in accordance with Appendix I, figures I1 to I3.

 <b>OTIF</b>	Uniform Technical Prescriptions <b>ACCESSIBILITY FOR PERSONS WITH DISABILITIES AND PERSONS WITH REDUCED MOBILITY</b>			UTP PRM Page 21 of 89
	Status: <b>PROPOSAL</b>	Version: 05	Ref.: A 94-05/1.2014	Original: EN

- 5) There shall be no obstruction of the designated space between the floor and the ceiling of the vehicle other than an overhead luggage rack, a horizontal handrail in accordance with the requirements of point 4.2.2.9 attached to the wall or ceiling of the vehicle, or a table.
- 6) The back of the wheelchair space shall be a structure or other acceptable fitting of at least 700mm wide. The height of the structure, or fitting, shall be capable of preventing a wheelchair that has been positioned with its back against the structure or fitting, from tipping over backwards.
- 7) Tip-up seats may be installed in the wheelchair space but, when in the stowed position, shall not encroach on the dimensional requirements of the wheelchair space.
- 8) It is not allowed to install any permanent equipment such as bicycle hooks or ski racks into the wheelchair space or directly in front of it.
- 9) At least one seat shall be available either adjacent to or facing to each of the wheelchair spaces for a companion to travel with the wheelchair user. This seat shall offer the same level of comfort as the other passenger seats, and may also be situated on the opposing side of the aisle.
- 10) On trains with a design speed higher than 250 km/h excepting double deck trains, it shall be possible for a wheelchair user occupying a wheelchair space to transfer onto a passenger seat that shall be equipped with a movable armrest. Such transfer is made by the wheelchair user in autonomy. In that case, it is allowed that the companion seat is shifted to another row. This requirement is applicable up to the number of wheelchair spaces per unit specified in table 5.
- 11) The wheelchair space shall be fitted with a call for aid device that shall, in the event of danger, provide to a wheelchair user the possibility to inform a person who can take appropriate action.
- 12) The call for aid device shall be placed within the comfortable reach range of the person using the wheelchair as shown in Appendix L, figure L1.
- 13) The call for aid device shall not be placed within a narrow recess which prevents immediate intentional palm operation but can be protected from unintentional use.
- 14) The interface of the call for aid device shall be as defined in point 5.3.2.6.
- 15) A sign conforming to appendix N shall be placed immediately next to, or in the wheelchair space so as to identify the space as the wheelchair space.

#### 4.2.2.3. Doors

##### 4.2.2.3.1 General

- 1) These requirements apply only to doors providing access to another public part of the train, with the exclusion of toilet doors.
- 2) To latch or unlatch a manually operated door, for use by the public, the control device shall be operable by the palm of the hand exerting a force not exceeding 20 N.
- 3) Door controls, whether manual, pushbuttons or other devices, shall contrast with the surface on which they are mounted.
- 4) Their interface with passengers shall comply with the specifications of point 5.3.2.1.
- 5) If both open and closed door control devices are fitted one above the other, the top device shall always be the open control.

 <b>OTIF</b>	Uniform Technical Prescriptions <b>ACCESSIBILITY FOR PERSONS WITH DISABILITIES AND PERSONS WITH REDUCED MOBILITY</b>			UTP PRM Page 22 of 89
	Status: <b>PROPOSAL</b>	Version: 05	Ref.: A 94-05/1.2014	Original: EN

#### 4.2.2.3.2 Exterior doors

- 1) All exterior passenger doorways shall have a minimum clear useable width of 800mm when open.
- 2) On trains with a design speed lower than 250 km/h, wheelchair access doors offering a level access as defined in point 2.3 shall have a minimum clear useable width of 1000mm when open.
- 3) All exterior passenger doorways shall be marked on the outside in a way that gives a contrast to the vehicle body-side surrounding them.
- 4) The designated wheelchair exterior accessible doorways shall be the closest doorways to the designated wheelchair spaces.
- 5) The doors to be used for wheelchair access shall be clearly labelled with a sign in accordance with appendix N.
- 6) From the inside of the vehicle the position of external doorways shall clearly be marked by use of contrasted adjacent flooring.
- 7) When a door is released for opening a signal shall be given that is clearly audible and visible to persons inside and outside the train. This alert signal shall last for a minimum of five seconds unless the door is operated, in which case it may cease after 3 seconds.
- 8) When a door is automatically or remotely opened by the driver or other member of the train crew, the alert signal shall last for a minimum 3 seconds from the moment that the door starts to open.
- 9) When a door that is automatically or remotely closed, is about to operate, an audible and visible alert signal shall be given to persons inside and outside the train. The alert signal shall start a minimum of 2 seconds before the door starts to close and shall continue while the door is closing.
- 10) The sound source for door alert signals shall be located in the area local to the control device or, if there is no such control device, adjacent to the doorway.
- 11) The visible signal shall be visible from inside and outside the train and shall be located such that it minimises the opportunity for it to be obscured by passengers located in the vestibule.
- 12) Passenger doors audible alert signals shall be according to the specification in appendix G.
- 13) The method of door activation shall be by train crew, semi-automatic (i.e. passenger pushbutton operation) or automatic.
- 14) The door control shall be located either next to or on the door leaf.
- 15) The centre of exterior door opening control, operable from the platform, shall be not less than 800mm and not more than 1200mm measured vertically above platforms, for all platforms for which the train is designed. If the train is designed for a single platform height, the centre of exterior door opening control shall be not less than 800mm and not more than 1100mm measured vertically above that platform height.
- 16) The centre of internal door opening control for the exterior door shall be not less than 800mm and not more than 1100mm measured vertically above the vehicle floor level.

#### 4.2.2.3.3 Interior doors

- 1) Internal automatic and semi-automatic doors shall incorporate devices that prevent passengers becoming trapped during operation of the doors.
- 2) Interior doors that are made available for wheelchair users shall have a minimum clear useable width of 800mm.
- 3) The force required to open or close a manual door shall not exceed 60 N.

 <b>OTIF</b>	Uniform Technical Prescriptions <b>ACCESSIBILITY FOR PERSONS WITH DISABILITIES AND PERSONS WITH REDUCED MOBILITY</b>			UTP PRM Page 23 of 89
	Status: <b>PROPOSAL</b>	Version: 05	Ref.: A 94-05/1.2014	Original: EN

- 4) The centre of interior door controls shall be not less than 800mm and not more than 1100mm measured vertically above the vehicle floor level.
- 5) Automatic inter-vehicle connecting doors shall operate either synchronously as a pair, or the second door shall automatically detect the person moving towards it and open.
- 6) If more than 75% of a door's surface is made of a transparent material, it shall be clearly marked with visual indicators.

#### 4.2.2.4. Lighting

- 1) Minimum values of average illuminance in the passenger areas shall be according to point 4.1.2 of the specification referenced in Appendix A, index 6. Requirements relative to the uniformity of these values are not applicable for conformity with this

UTP.

TSI.

#### 4.2.2.5. Toilets

- 1) When toilets are fitted in a train, a universal toilet shall be provided accessible from the wheelchair space.
- 2) The standard toilet shall be compliant with the requirements of points 5.3.2.2 and 5.3.2.3.
- 3) The universal toilet shall be compliant with the requirements of points 5.3.2.2 and 5.3.2.4.
- 4) When toilets are fitted in a train a baby nappy changing facility shall be provided. If separate nursery facilities are not provided or if separate nursery facilities are provided but are not accessible to a wheelchair user, a table shall be incorporated within the universal toilets. It shall be compliant with the requirements of point 5.3.2.5.

#### 4.2.2.6. Clearways

- 1) From the vehicle entrance, the section of the clearway shall be as follows:
  - through the vehicles according to figure J1 of Appendix J,
  - between connecting vehicles of a single trainset, according to figure J2 of Appendix J,
  - to and from wheelchair accessible doors, wheelchair spaces and wheelchair accessible areas including sleeping accommodation and universal toilets if provided, according to figure J3 of Appendix J.
- 2) The minimum height requirement does not need to be verified in:
  - all areas of double-deck vehicles,
  - gangways and door areas of single deck vehicles,

In those areas, reduced headroom is accepted as a consequence of structural constraints (gauge, physical space).
- 3) A turning space, with a minimum diameter of 1500mm, shall be provided adjacent to the wheelchair space and in other locations where wheelchairs are supposed to turn 180°. The wheelchair space may be part of the turning circle.

 <b>OTIF</b>	Uniform Technical Prescriptions <b>ACCESSIBILITY FOR PERSONS WITH DISABILITIES AND PERSONS WITH REDUCED MOBILITY</b>			UTP PRM Page 24 of 89
	Status: <b>PROPOSAL</b>	Version: 05	Ref.: A 94-05/1.2014	Original: EN

- 4) If a change in direction is required for a wheelchair user, the clearway width of both corridors shall be in accordance to table K1 of Appendix K.

#### 4.2.2.7. Customer Information

##### 4.2.2.7.1 General

- 1) The following information shall be provided:
- Safety Information and Safety Instructions
  - Audible safety instructions coupled with visible signals in case of emergency
  - Warning, prohibition and mandatory actions signs
  - Information concerning the route of the train, including information about delays and unplanned stops,
  - Information concerning the location of on-board facilities
- 2) Visual information shall contrast with its background.
- 3) The typeface used for texts shall be easily readable.
- 4) Time information presented in digits shall be in the 24h system

##### 4.2.2.7.2 Signage, pictograms and tactile information

- 1) All safety, warning, mandatory action and prohibition signs shall include pictograms and shall be designed according to the specification referenced in Appendix A, index 7.
- 2) There shall be no more than five pictograms, together with a directional arrow, indicating a single direction placed adjacent to each other at a single location.
- 3) The following specific pictograms shall be fitted with the wheelchair symbol in accordance with appendix N:
- Directional information for wheelchair accessible amenities
  - Indication of the wheelchair accessible door location outside the train
  - Indication of the wheelchair space inside the train
  - Indication of the universal toilets

The symbols can be combined with other symbols (for example: carriage number, toilet, etc).

- 4) Where inductive loops are fitted these shall be indicated by a pictogram complying with appendix N.
- 5) In universal toilets, where hinged handrails are provided, a pictogram showing the rail in both the stowed and deployed positions shall be provided.
- 6) If a vehicle provides reserved seats then the number or letter of that vehicle (as used in the reservation system) shall be displayed externally on or adjacent to all its access doors. The number or letter shall be displayed in characters not less than 70mm high and shall be visible when the door is open and closed.



 <b>OTIF</b>	Uniform Technical Prescriptions <b>ACCESSIBILITY FOR PERSONS WITH DISABILITIES AND PERSONS WITH REDUCED MOBILITY</b>			UTP PRM Page 25 of 89
	Status: <b>PROPOSAL</b>	Version: 05	Ref.: A 94-05/1.2014	Original: EN

- 7) If seats are identified by numbers or letters, the number or letter of the seat shall be displayed on or adjacent to every seat in characters not less than 12mm high. Such numbers and letters shall contrast with their background.
- 8) Tactile information signage shall be fitted in:
  - Toilets and wheelchair accessible sleeping accommodation, for functional information and call for aid device if appropriate
  - Rolling stock, for the open/close button of passenger accessible doors and call for aid devices

#### 4.2.2.7.3 Dynamic Visual Information

- 1) The final destination or route shall be displayed on the outside of the train on the platform side adjacent to at least one of the passenger access doors on a minimum of alternate vehicles of the train.
- 2) Where trains operate in a system, in which dynamic visual information is given on the station platform every 50m or less, and destination or route information is also provided on the front of the train, it is not mandatory to provide information on the sides of vehicles.
- 3) The final destination or route of the train shall be displayed inside each vehicle.
- 4) The next stop of the train shall be displayed such that it can be read from a minimum of 51% of passenger seats inside each vehicle including 51% of the priority seats, and from all wheelchair spaces.
- 5) This information shall be displayed at least two minutes before arrival at the station concerned. If the next station is less than two minutes planned journey time away, the next station shall be displayed immediately following departure from the previous station.
- 6) The requirement to make the destination and 'next stop' information visible from 51% of passenger seats does not apply to compartment carriages where the compartments have a maximum of 8 seats and are served by an adjacent corridor. However, this information shall be visible to a person standing in a corridor outside a compartment and to a passenger occupying a wheelchair space.
- 7) The information about the next stop may be displayed on the same support as the final destination. However, it shall revert to show the final destination as soon as the train has stopped.
- 8) If the system is automated, it shall be possible to suppress or correct incorrect or misleading information.
- 9) Internal and external displays shall comply with the requirements of point 5.3.2.7. In this point, the term "display" shall be understood as any support of dynamic information.

#### 4.2.2.7.4 Dynamic audible information

- 1) The train shall be fitted with a public address system which shall be used either for routine or emergency announcements by the driver or by another crew member who has specific responsibility for passengers.
- 2) The public address system may operate on a manual, an automated or pre-programmed basis. If the public address system is automated, it shall be possible to suppress, or correct, incorrect or misleading information.
- 3) The public address system shall be capable of announcing the destination and next stop of the train at each stop, or on departure from each stop.

 <b>OTIF</b>	Uniform Technical Prescriptions <b>ACCESSIBILITY FOR PERSONS WITH DISABILITIES AND PERSONS WITH REDUCED MOBILITY</b>			UTP PRM Page 26 of 89
	Status: <b>PROPOSAL</b>	Version: 05	Ref.: A 94-05/1.2014	Original: EN

- 4) The public address system shall be capable of announcing the next stop of the train at least two minutes before the arrival of the train at that stop. If the next station is less than two minutes planned journey time away, the next station shall be announced immediately following departure from the previous station.
- 5) The spoken information shall have a minimum STI-PA level of 0.45, in accordance with the specification referenced in Appendix A, index 5. The public address system shall meet the requirement at all seat locations and wheelchair spaces.

#### 4.2.2.8. Height changes

- 1) Internal steps (other than those for external access) shall have a maximum height of 200mm and a minimum depth of 280mm, measured at the central axis of the stairs. For double deck trains it is permitted to reduce this value to 270mm for the stairs accessing the upper deck and the lower deck.
- 2) As a minimum the first and the last step shall be indicated by a contrasting band with a depth of 45mm to 55mm extending the full width of the steps on both the front and the top surfaces of the step nosing.
- 3) Stairs constituted of more than three steps shall be provided with handrails on both sides and at two levels. The higher handrail shall be positioned at a height of 850mm to 1000mm above floor level. The lower handrail shall be positioned at a height of 500mm to 750mm above floor level.
- 4) Stairs constituted of one, two or three steps shall be provided on both sides with a minimum of one handrail or other item that can be used for personal stability.
- 5) Handrails shall be compliant with point 4.2.2.9.
- 6) No steps are allowed between the vestibule of a wheelchair accessible exterior door, the wheelchair space, a universal sleeping compartment and the universal toilet except for a door threshold strip that shall not exceed 15mm in height or except in case that a lift is provided to overcome the step. The lift shall comply with the requirements of point 5.3.2.10.
- 7) For ramps in rolling stock the maximum slope shall not exceed the following values:

<u>Length of ramp</u>	<u>Maximum gradient (degrees)</u>	<u>Maximum gradient (%)</u>
Paths between the vestibule of a wheelchair accessible exterior door, the wheelchair space, a wheelchair accessible sleeping accommodation and the universal toilet		
Up to 840mm in single deck carriages	6,84	12
Up to 840mm in double deck carriages	8.5	15
> 840mm	3,58	6,25
Other areas of the train		
> 1000mm	6.84	12

 <b>OTIF</b>	Uniform Technical Prescriptions <b>ACCESSIBILITY FOR PERSONS WITH DISABILITIES AND PERSONS WITH REDUCED MOBILITY</b>			UTP PRM Page 27 of 89
	Status: <b>PROPOSAL</b>	Version: 05	Ref.: A 94-05/1.2014	Original: EN

600mm to 1000mm	8,5	15
Less than 600mm	10,2	18

Table 6: maximum slope for ramps in rolling stock

Note: These gradients shall be measured when the vehicle is stationary on straight and level track.

#### 4.2.2.9. Handrails

- 1) All handrails fitted to a vehicle shall be round in section with an outside diameter of 30mm to 40mm, and shall have a minimum clear distance of 45mm to any adjacent surface other than its mountings.
- 2) If a handrail is curved, the radius to the inside face of the curve shall be a minimum of 50mm.
- 3) All handrails shall contrast with their background.
- 4) External doorways shall be provided with handrails on both sides, fitted internally as close as practicable to the vehicle outer wall. Exception can be made for one side of the doorway if it is fitted with a device such as an on-board lift.
- 5) Those handrails shall be:
  - vertical handrails that shall extend from 700mm to 1200mm above the threshold of the first step for all external doorways.
  - additional handrails at a height of between 800mm and 900mm above the first useable step and parallel with the line of the step nosing for doorways with more than two entrance steps.
- 6) Where the clearway of the gangway is narrower than 1000mm and longer than 2000mm there shall be handrails or handholds provided in, or adjacent to, inter-vehicle gangways that are provided for passenger use.
- 7) Where the clearway of the gangway is wider than or equal to 1000mm handrails or handholds shall be provided in the gangway.

#### 4.2.2.10. Wheelchair accessible sleeping accommodation

- 1) When a train is equipped with sleeping accommodation for passengers, it shall provide a vehicle containing at least one wheelchair accessible sleeping accommodation.
- 2) If there is more than one vehicle with sleeping accommodation for passengers in a train, there shall be not less than two wheelchair accessible sleeping accommodations in the train.
- 3) If a rail vehicle provides wheelchair accessible sleeping accommodation, the exterior of the relevant vehicle door and the wheelchair accessible sleeping accommodation door shall be marked with a sign in accordance with appendix N.
- 4) The wheelchair accessible sleeping accommodation internal space shall take in consideration the requirements of point 4.2.2.6 for actions expected from the wheelchair user in the sleeping accommodation.

 <b>OTIF</b>	Uniform Technical Prescriptions <b>ACCESSIBILITY FOR PERSONS WITH DISABILITIES AND          PERSONS WITH REDUCED MOBILITY</b>			UTP PRM Page 28 of 89
	Status: <b>PROPOSAL</b>	Version: 05	Ref.: A 94-05/1.2014	Original: EN

- 5) The sleeping accommodation shall be fitted with not less than two call for aid devices that shall when operated, send a signal to a person who can take appropriate action; they need not initiate a communication.
- 6) The interface of the call for aid devices shall be as defined in point 5.3.2.6.
- 7) One call for aid device shall be placed not more than 450mm above the floor, measured vertically from the surface of the floor to the centre of the control. It shall be positioned so that the control can be reached by a person lying on the floor.
- 8) The other call for aid device shall be not less than 600mm and not more than 800mm above the floor measured vertically to the centre of the control.
- 9) These two call for aid devices shall be located on different vertical surfaces of the sleeping accommodation.
- 10) The call for aid devices shall be distinct from any other control within the sleeping accommodation, be coloured differently from other control devices and contrast with their background.

#### 4.2.2.11. Step position for vehicle access and egress

##### 4.2.2.11.1 General requirements

- 1) It shall be demonstrated that the point situated in the central position on the nose of the access step of each passenger access door on both sides of a vehicle in working order with new wheels standing centrally on the rails, shall be located inside the surface identified as "step location" on the figure 1 below.

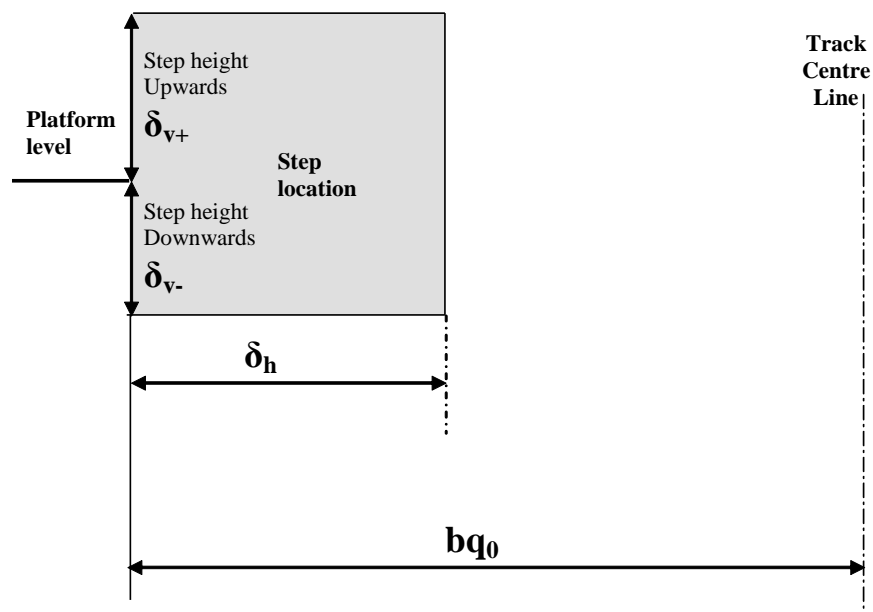



FIGURE 1

- 2) The values of  $bq_0$ ,  $\delta_h$ ,  $\delta_{v+}$  and  $\delta_{v-}$  depend on the type of platform where the rolling stock is intended to stop. They shall be as follows:
  - $bq_0$  shall be calculated based on the gauge of the track in which the train is intended to operate in accordance with the specification referenced in Appendix A, index 8.

 <b>OTIF</b>	Uniform Technical Prescriptions <b>ACCESSIBILITY FOR PERSONS WITH DISABILITIES AND PERSONS WITH REDUCED MOBILITY</b>			UTP PRM Page 29 of 89
	Status: <b>PROPOSAL</b>	Version: 05	Ref.: A 94-05/1.2014	Original: EN

The calculation shall take into account the loading gauge(s) on which the vehicle is designed to be operated.

Gauges are defined in chapter 4.2.3.1 of INF TSI.

- $\delta_h$ ,  $\delta_{v+}$  and  $\delta_{v-}$  are defined in tables 7 - 9.

**Table 7 for all Rolling Stock intended to stop, in normal operation, at platforms of 550mm height:**

	$\delta_h$ mm	$\delta_{v+}$ mm	$\delta_{v-}$ mm
on a straight level track	200	230	160
on a track with a curve radius of 300m	290	230	160

Table 7: values of  $\delta_h$ ,  $\delta_{v+}$  and  $\delta_{v-}$  for a 550mm platform

**Table 8 for all Rolling Stock intended to stop, in normal operation, at platforms of 760mm height:**

	$\delta_h$ mm	$\delta_{v+}$ mm	$\delta_{v-}$ mm
on a straight level track	200	230	160
on a track with a curve radius of 300m	290	230	160

Table 8: values of  $\delta_h$ ,  $\delta_{v+}$  and  $\delta_{v-}$  for a 760mm platform

**Table 9 for all Rolling Stock intended to stop, in normal operation, at both platforms of 760mm height and platforms of 550mm height, and having two or more access steps:**

For one step, values of the table 7 above apply, and for the next step towards the vehicle interior the following values apply, based upon a nominal platform height of 760 mm:

	$\delta_h$ mm	$\delta_{v+}$ mm	$\delta_{v-}$ mm
on a straight level track	380	230	160
on a track with a curve radius of 300m	470	230	160

Table 9: values of  $\delta_h$ ,  $\delta_{v+}$  and  $\delta_{v-}$  for the second step for a 760mm platform

- 3) The technical documentation requested in point 4.2.12 of the

UTP LOC&PAS

LOC&PAS TSI

shall include information about the height and offset of the theoretical platform resulting in a vertical gap ( $\delta_{v+}$ ) of 230mm and in a horizontal gap ( $\delta_h$ ) of 200mm from the point situated in the central position of the nose of the rolling stock's lowest step on a straight level track.

#### 4.2.2.11.2 Access/egress steps

- 1) All steps for access and egress shall be slip resistant and shall have an effective clear width as large as the doorway width.
- 2) Internal steps for external access shall have a minimum depth of 240mm between the vertical edges of the step and a maximum height of 200mm. The height of each step may be increased to a

 <b>OTIF</b>	Uniform Technical Prescriptions <b>ACCESSIBILITY FOR PERSONS WITH DISABILITIES AND PERSONS WITH REDUCED MOBILITY</b>			UTP PRM Page 30 of 89
	Status: <b>PROPOSAL</b>	Version: 05	Ref.: A 94-05/1.2014	Original: EN

maximum of 230mm if it can be demonstrated that this achieves a reduction of one in the total number of steps required.

- 3) The rising height of each step shall be equal.
- 4) As a minimum the first and the last steps shall be indicated by a contrasting band with a depth of 45mm to 55mm extending a minimum of 80% of the width of the steps on the top surface of the step nosing. A similar band shall indicate the front surface of the last step when entering the unit.
- 5) An external access step, fixed or moveable, shall have a maximum height of 230 mm between steps and a minimum depth of 150 mm.
- 6) If a step board is fitted and it is an extension of a door sill outside the vehicle, and there is no change in level between the step board and the floor of the vehicle, this shall not be considered to be a step for the purposes of this specification. A minimal drop in level, with a maximum of 60 mm, between the floor surface at door sill and that of the exterior of the vehicle, used to guide and seal the door is also permissible and shall not be considered as a step.
- 7) Access to the vestibule of the vehicle shall be achieved with a maximum of 4 steps of which one may be external.
- 8) Rolling Stock intended to stop, in normal operation, at existing platforms below 380mm height and having their passenger access doors above bogies need not comply with points (2) and (5) above if it can be demonstrated that this achieves a more even distribution of the steps heights.

#### 4.2.2.12. Boarding aids

- 1) A secure storage system shall be provided to ensure that boarding aids, including portable ramps, do not impinge on a passenger's wheelchair or mobility aid or pose any hazard to passengers in the event of a sudden stop.
- 2) The following types of boarding aids may be present in the rolling stock according to the rules defined in point 4.4.3.

##### 4.2.2.12.1 Movable step and bridging plate

- 1) A moveable step is a retractable device integrated into the vehicle lower than the door threshold level, fully automatic and activated in conjunction with the door opening/closing sequences.
- 2) A bridging plate is a retractable device integrated into the vehicle as close as possible to the door threshold level, fully automatic and activated in conjunction with the door opening/closing sequences.
- 3) In the case of the movable step or bridging plate extending beyond that permitted by the gauging rules, the train shall be immobilised whilst the step or plate is extended.
- 4) The extension of the moveable step or bridging plate shall be completed before the door opening permits the passengers to cross and conversely, removal of the step or plate may only begin when the door opening no longer permits any crossing of passengers.
- 5) Movable steps and bridging plates shall comply with the requirements of point 5.3.2.8.

##### 4.2.2.12.2 On-board ramp

- 1) An on-board ramp is a device that is positioned between the vehicle door threshold and the platform. It can be manual, semi-automatic or automatic.

 <b>OTIF</b>	Uniform Technical Prescriptions <b>ACCESSIBILITY FOR PERSONS WITH DISABILITIES AND          PERSONS WITH REDUCED MOBILITY</b>			UTP PRM Page 31 of 89
	Status: <b>PROPOSAL</b>	Version: 05	Ref.: A 94-05/1.2014	Original: EN

- 2) On-board ramps shall comply with the requirements of point 5.3.2.9.

#### 4.2.2.12.3 On-board lift

- 1) An on-board lift is a device integrated into the doorway of a vehicle that shall be able to overcome the maximum height difference between the vehicle floor and the station platform where operated.
- 2) When the lift is in the stowed position the doorway shall have a minimum useable width according to point 4.2.2.3.2.
- 3) On-board lifts shall comply with the requirements of point 5.3.2.10.

### 4.3. FUNCTIONAL AND TECHNICAL SPECIFICATIONS OF THE INTERFACES

The tables in section 4.3 are in a 5 column layout. The first column on the left hand side does not appear in the TSI. The titles of the columns have also been adapted by including 'UTP'

#### 4.3.1. Interfaces with the Infrastructure subsystem

<b>Reference to the OTIF or national regulations</b>	<b>Interface with the Infrastructure subsystem</b>			
	<b>UTP PRM / PRM TSI</b>		<b>INF TSI</b>	
	<b>Parameter</b>	<b>Point</b>	<b>Parameter</b>	<b>Point</b>
There are no infrastructure requirements in OTIF regulations.  In accordance with ATMF Article 6 § 2, it is the responsibility of the rail transport undertaking to ensure the compatibility of the vehicle with the infrastructure it is operated on.  The track design and layout are the responsibility of the Contracting State.	Step position for vehicle access and egress	4.2.2.11	Platforms	4.2.9
	Specific cases about the step position for vehicle access and egress	7.3.2.6	Specific cases about platforms	7.7

Table 10: Interface with the Infrastructure subsystem

 <b>OTIF</b>	Uniform Technical Prescriptions <b>ACCESSIBILITY FOR PERSONS WITH DISABILITIES AND PERSONS WITH REDUCED MOBILITY</b>			UTP PRM Page 32 of 89
	Status: <b>PROPOSAL</b>	Version: 05	Ref.: A 94-05/1.2014	Original: EN

#### 4.3.2. Interfaces with the Rolling Stock subsystem

<i>Reference to the OTIF or national regulations</i>	<i>Interface with the rolling stock subsystem</i>			
	UTP PRM / PRM TSI		LOC&PAS TSI	
	Parameter	Point	Parameter	Point
Set out by the UTP LOC&PAS (Point 4.2.5) and by this UTP	Rolling Stock subsystem	4.2.2	Passenger related items	4.2.5

Table 11: Interface with the Rolling Stock subsystem

#### 4.3.3. Interfaces with the Telematics Applications for Passengers subsystem

<i>Reference to the OTIF or national regulations</i>	<i>Interface with the TAP subsystem</i>			
	UTP PRM / PRM TSI		TAP TSI	
	Parameter	Point	Parameter	Point
There are no harmonised requirements for telematics applications for passengers in OTIF.	Station accessibility	4.4.1	Handling of information concerning carriage and assistance of persons with disabilities and persons with reduced mobility	4.2.6
	Assistance to board and alight the train			
	Assistance to board and alight the train	4.4.2	Handling of information concerning carriage and assistance of persons with disabilities and persons with reduced mobility	4.2.6
	Access and reservation	4.4.2	Handling of availability/reservation	4.2.9



 <b>OTIF</b>	Uniform Technical Prescriptions <b>ACCESSIBILITY FOR PERSONS WITH DISABILITIES AND PERSONS WITH REDUCED MOBILITY</b>			UTP PRM Page 33 of 89
	Status: <b>PROPOSAL</b>	Version: 05	Ref.: A 94-05/1.2014	Original: EN

<i>Reference to the OTIF or national regulations</i>	<i>Interface with the TAP subsystem</i>			
	<b>UTP PRM / PRM TSI</b>		<b>TAP TSI</b>	
	Visual information	4.2.1.10	Handling of information provision in the station area	4.2.12
	Spoken information	4.2.1.11	Handling of information provision in the station area	4.2.12
	Customer information	4.2.2.7	Handling of information provision in the vehicle area	4.2.13

Table 12: Interface with the Telematics Applications for Passengers subsystem

#### 4.4. OPERATING RULES

The following operating rules do not form part of the assessment of subsystems.

This

UTP

TSI

does not specify operating rules for evacuation in the case of hazardous situations, only the relevant technical requirements. The purpose of the technical requirements for Infrastructure and Rolling Stock is to facilitate evacuation for all, including persons with disabilities and persons with reduced mobility.

As set out in point 2.1.3 of this UTP, the applicable operating rules are set out in Appendix K<sup>9</sup> to the UTP LOC&PAS. The application of operational requirements as set out in this UTP PRM is subject to national implementation and is not mandatory within the scope of this UTP.

<sup>9</sup> Appendix K to the UTP LOC&PAS sets out requirements related to train composition and the safe use of vehicles. In particular for train composition, the requirements in this UTP PRM are relevant, e.g. for the number of wheelchair accessible toilets and the number of priority seats in a train.

 <b>OTIF</b>	Uniform Technical Prescriptions <b>ACCESSIBILITY FOR PERSONS WITH DISABILITIES AND PERSONS WITH REDUCED MOBILITY</b>			UTP PRM Page 34 of 89
	Status: <b>PROPOSAL</b>	Version: 05	Ref.: A 94-05/1.2014	Original: EN

#### 4.4.1. *Infrastructure subsystem*

In light of the essential requirements in section 3, the operating rules specific to the infrastructure subsystem related to accessibility for persons with disabilities and persons with reduced mobility are as follows:

- General

The Infrastructure Manager or Station Manager shall have a written policy to ensure that all persons with disabilities and persons with reduced mobility can access the passenger infrastructure at all operational times in accordance with the technical requirements of this

UTP.

TSI.

Furthermore, the policy shall be compatible with any Railway Undertaking's policy that may wish to use the facilities, (refer to point 4.4.2) as appropriate. The policy shall be implemented through the provision of adequate information to staff, procedures and training. The Infrastructure policy shall include, but not be limited to, operating rules for the following situations:

- Station Accessibility

Operating rules shall be made to ensure that information regarding the level of accessibility of all stations is available.

- Unstaffed Stations – Ticketing for Visually Impaired Passengers

Operating rules shall be written and implemented with respect to unstaffed stations where vending machines are relied upon for ticketing (refer to point 4.2.1.8). In such situations, an alternative means of ticketing, accessible to visually impaired passengers, shall always be available (for example, permitting purchasing either on the train or at the destination).

- Ticketing Control – Turnstiles

In cases where turnstiles are utilised for ticketing control, operational rules shall be implemented, whereby disabled persons and persons with reduced mobility are offered parallel access through such control points. This special access shall permit wheelchair users, and may be controlled by staff or be automatic.

- Lighting of platforms

It is allowed that lighting be switched off on platforms where no train is expected.

- Visual and Spoken Information – Achieving Consistency

Operating rules shall be implemented to ensure consistency between essential visual and spoken information (refer to points 4.2.1.10 and 4.2.1.11). Staff making announcements shall follow standard procedures to achieve complete consistency of essential information.

Advertisements shall not be combined with the routing information.

 <b>OTIF</b>	Uniform Technical Prescriptions <b>ACCESSIBILITY FOR PERSONS WITH DISABILITIES AND PERSONS WITH REDUCED MOBILITY</b>			UTP PRM Page 35 of 89
	Status: <b>PROPOSAL</b>	Version: 05	Ref.: A 94-05/1.2014	Original: EN
Date: 28.03.2014				

Note: General information about public transport services shall not be considered as advertisements for the purposes of this point.

- On-demand Spoken Passenger Information System

Where spoken information is not provided via a public address system at a station (refer to point 4.2.1.11), operating rules shall be implemented to ensure the provision of an alternative information system, whereby passengers are able to acquire the same information audibly at the station (e.g. a staffed or automated telephone information service).

- Platform – Wheelchair Boarding Aid Operational Zone

The Railway Undertaking and the Infrastructure Manager or Station Manager shall define together the area(s) on the platform where the facility is likely to be used, taking account of train composition variations.

Operational rules shall be implemented to determine, where possible, the stopping point of trains according to the location of this (or these) operational zone(s).

- Safety of Manual and Powered Wheelchair Boarding Aids

Operations rules shall be implemented concerning the operation of boarding aids by station staff (refer to point 4.2.1.14).

An operational rule shall be implemented concerning the use by staff of the moveable safety barrier fitted to wheelchair lifts (refer to point 4.2.1.14).

Operational rules shall be implemented to ensure that staff is able to safely operate boarding ramps, with respect to deployment, securing, raising, lowering and stowing (refer to point 4.2.1.14).

- Assistance to board and alight the train

Operational rules shall be implemented to ensure that staff are aware that persons with disabilities and persons with reduced mobility may require assistance to board and alight the train, and shall provide such assistance if required.

Conditions on which assistance to persons with disabilities and persons with reduced mobility is provided are defined in Regulation (EC) No 1371/2007<sup>10</sup>

, which applies in the EU.

| .

- Supervised Level Track Crossing

Where supervised level track crossing is permitted, operating rules shall be implemented to ensure that staff at supervised level track crossings give appropriate assistance to persons with disabilities and persons with reduced mobility, including indication of when it is safe to cross the track.

<sup>10</sup> Regulation (EC) No 1371/2007 of the European Parliament and of the Council of 23 October 2007 on rail passengers' rights and obligations (OJ L 315, 3.12.2007, p. 14–41).

 <b>OTIF</b>	Uniform Technical Prescriptions <b>ACCESSIBILITY FOR PERSONS WITH DISABILITIES AND PERSONS WITH REDUCED MOBILITY</b>			UTP PRM Page 36 of 89
	Status: <b>PROPOSAL</b>	Version: 05	Ref.: A 94-05/1.2014	Original: EN

#### 4.4.2. *Rolling Stock subsystem*

In light of the essential requirements in section 3, the operating rules specific to the Rolling Stock subsystem related to accessibility for persons with disabilities and persons with reduced mobility are as follows:

- General

The Railway Undertaking shall have a written policy to ensure accessibility to passenger Rolling Stock at all operational times in accordance with the technical requirements of this

UTP.

TSI.

Furthermore, the policy shall be compatible with the Infrastructure Manager or Station Manager policy (refer to point 4.4.1) as appropriate. The policy shall be implemented through the provision of adequate information to staff, procedures and training. The Rolling Stock policy shall include, but not be limited to, operating rules for the following situations:

- Access and Reservation of Priority Seats

Two possible conditions exist in connection with seats classified as ‘priority’: (i) unreserved and (ii) reserved (refer to point 4.2.2.1.2). In case (i) the operating rules will be directed to other passengers (i.e. provision of signage) requesting them to ensure that priority is given to all persons with disabilities and persons with reduced mobility that are defined as being eligible to use such seats and that occupied priority seats should be given-up as appropriate. In case (ii) operating rules shall be implemented by the Railway Undertaking to ensure that the ticketing reservation system is equitable with regards to persons with disabilities and persons with reduced mobility. Such rules will ensure that priority seating is initially only available for reservation by persons with disabilities and persons with reduced mobility until a given cut-off period prior to departure. After this point in time, priority seats will be made available to the entire passenger population, including persons with disabilities and persons with reduced mobility.

- Carriage of Assistance Dogs

Operating rules shall be made to ensure that persons with disabilities and persons with reduced mobility with an assistance dog shall not be charged extra.

- Access and Reservation of Wheelchair Spaces

The priority seating access and reservation rules also apply to wheelchair spaces, with only wheelchair users having priority. Additionally, operating rules shall provide for (i) unreserved or (ii) reserved accompanying persons (non-PRM) seating adjacent or facing the wheelchair space.

- Access and Reservation of Universal Sleeping Compartments

The priority seating reservation rules also apply to universal sleeping compartments (refer to point 4.2.2.10). However, operational rules shall prevent non-reserved occupation of universal sleeping compartments (i.e. advanced booking will always be necessary).

 <b>OTIF</b>	Uniform Technical Prescriptions <b>ACCESSIBILITY FOR PERSONS WITH DISABILITIES AND PERSONS WITH REDUCED MOBILITY</b>			UTP PRM Page 37 of 89
	Status: <b>PROPOSAL</b>	Version: 05	Ref.: A 94-05/1.2014	Original: EN

- Train crew Exterior doors activation

Operational rules shall be implemented regarding the procedure for external door activation by train crew to ensure safety of all passengers including persons with disabilities and persons with reduced mobility (refer to point 4.2.2.3.2).

- Call for aid device in wheelchair space, universal toilets or wheelchair accessible sleeping accommodation

Operational rules shall be implemented to ensure appropriate response and action from the staff in the event of activation of the call for aid device (refer to paragraphs 4.2.2.2, 4.2.2.5 and 4.2.2.10). Response and action need not be the same according to the origin of the call for aid.

- Audible safety instructions in case of emergency

Operational rules shall be implemented regarding the transmission of audible safety instructions to passengers in the event of an emergency (refer to point 4.2.2.7.4). These rules shall include the nature of the instructions and of their transmission.

- Visual and audible Information – Control of Advertisements

Details of the Route or Network on which the train operates shall be available (Railway Undertaking shall decide the manner in which this information is provided).

Advertisements shall not be combined with routing information.

Note: General information about public transport services shall not be considered as advertisements for the purposes of this point.

- Automatic Information Systems - Manual Correction of incorrect or misleading information

Operational rules shall be implemented for the validation and ability to correct erroneous automatic information by the train crew (refer to point 4.2.2.7).

- Rules for announcement of the final destination and the next stop

Operational rules shall be implemented to ensure that the next stop is announced no later than 2 minutes prior to the event (refer to point 4.2.2.7).

- Rules on train composition to make wheelchair boarding aid devices usable according to the arrangement of the platforms.

Operational rules shall be implemented to take account of train composition variations such that the safe operational zones for wheelchair boarding aids can be determined with respect to the stopping point of trains.

- Safety of Manual and Powered Wheelchair Boarding Aids

 <b>OTIF</b>	Uniform Technical Prescriptions <b>ACCESSIBILITY FOR PERSONS WITH DISABILITIES AND PERSONS WITH REDUCED MOBILITY</b>			UTP PRM Page 38 of 89
	Status: <b>PROPOSAL</b>	Version: 05	Ref.: A 94-05/1.2014	Original: EN

Operations rules shall be implemented concerning the operation of boarding aids by train and station staff. In the case of manual devices, procedures shall ensure that minimum physical effort is required from staff. In the case of powered devices, procedures shall ensure emergency fail-safe-operation in the event of loss of power. An operational rule shall be implemented concerning the use by train or station staff of the moveable safety barrier fitted to wheelchair lifts.

Operational rules shall be implemented to ensure that train and station staff is able to safely operate boarding ramps, with respect to deployment, securing, raising, lowering and stowing.

- Assistance to board and alight the train

Operational rules shall be implemented to ensure that staff are aware that disabled persons and persons with reduced mobility may require assistance to board and alight the train, and shall provide such assistance if required.

Conditions on which assistance to persons with disabilities and persons with reduced mobility is provided are defined

for the EU

in Regulation (EC) No 1371/2007.

There are no equivalent provisions in force in COTIF and therefore Contracting States which do not apply the EU regulation are recommended to implement equivalent national rules.

- Platform – Wheelchair Boarding Aid Operational Zone

The Railway Undertaking and the Infrastructure Manager or Station Manager shall define together the area on the platform where the facility is likely to be used and shall demonstrate its validity. This area shall be compatible with the existing platforms where the train is likely to stop.

A consequence of above is that the stopping point of the train shall in some cases be adjusted in order to comply with this requirement.

Operational rules shall be implemented to take account of train composition variations (refer to point 4.2.1.12) such that the stopping point of trains can be determined with respect to the boarding aid operational zones.

- Emergency method to deploy moveable steps

Operational rules shall be implemented for the emergency stowage or deployment of the bridging plate in the case of power failure.

Operating combinations of Rolling Stock compliant and non-compliant with this

UTP

TSI

 <b>OTIF</b>	Uniform Technical Prescriptions <b>ACCESSIBILITY FOR PERSONS WITH DISABILITIES AND PERSONS WITH REDUCED MOBILITY</b>			UTP PRM Page 39 of 89
	Status: <b>PROPOSAL</b>	Version: 05	Ref.: A 94-05/1.2014	Original: EN

When forming a train from a mixture of compliant and non-compliant Rolling Stock, operational procedures shall be implemented to ensure that a minimum of two wheelchair spaces compliant with this

UTP

TSI

are provided on the train. If toilets are available on the train, it shall be ensured that wheelchair users have access to a universal toilet.

Under such Rolling Stock combinations, procedures shall be in place to ensure that visual and audible route information is available on all vehicles.

It is accepted that dynamic information systems and wheelchair space/universal toilet/wheelchair accessible sleeping accommodation call for aid devices may not be fully functional when working in such formations.

- Forming trains from individual vehicles compliant with this

UTP

TSI

When vehicles that have been individually assessed in accordance with point 6.2.7 are formed into a train, operational procedures shall be in place to ensure that the complete train complies with point 4.2 of this

UTP.

TSI.

#### 4.4.3. *Provision of boarding aids and provision of assistance*

The Infrastructure Manager or Station Manager and Railway Undertaking shall agree the provision and management of the boarding aids as well as the provision of assistance and alternative transport

in the EU,

in line with Regulation 1371/2007

in order to establish which party is responsible for operation of boarding aids and alternative transport. The Infrastructure Manager (or Station Manager(s)) and Railway Undertaking shall ensure that the division of responsibilities they agree is the most viable overall solution.

Such agreements shall define:

- the station platforms where a boarding aid has to be operated by the Infrastructure Manager or the Station Manager and the Rolling Stock for which it will be used,
- the station platforms where a boarding aid has to be operated by the Railway Undertaking and the Rolling Stock for which it will be used,
- the Rolling Stock where a boarding aid has to be provided and operated by the Railway Undertaking and the station platform where it will be used,

 <b>OTIF</b>	Uniform Technical Prescriptions <b>ACCESSIBILITY FOR PERSONS WITH DISABILITIES AND PERSONS WITH REDUCED MOBILITY</b>			UTP PRM Page 40 of 89
	Status: <b>PROPOSAL</b>	Version: 05	Ref.: A 94-05/1.2014	Original: EN

- the Rolling Stock where a boarding aid has to be provided by the Railway Undertaking and operated by the Infrastructure Manager or Station Manager, and the station platforms where it will be used.
- the conditions for the provision of alternative transport where:
  - the platform cannot be reached through an obstacle-free route, or
  - assistance cannot be provided to deploy a boarding aid between the platform and the rolling stock.

## 4.5. MAINTENANCE RULES

### 4.5.1. *Infrastructure Subsystem*

The requirement in this clause relates to the operational performance of the infrastructure during maintenance. Compliance with this clause in non-EU Contracting States is recommended but not mandatory, as the application of this UTP to the infrastructure subsystem is not mandatory.

The Infrastructure Manager or Station Manager shall have procedures that include the provision of alternative assistance to disabled persons and persons with reduced mobility during maintenance, replacement or repair of facilities that are for use of persons with disabilities and persons with reduced mobility.

### 4.5.2. *Rolling Stock Subsystem*

If a facility that has been incorporated for persons with disabilities and persons with reduced mobility becomes defective (this includes tactile signs), the Railway Undertaking shall ensure that he has procedures for the facility to be repaired or replaced within 6 working days of the occurrence being reported.

## 4.6. PROFESSIONAL QUALIFICATIONS

The requirements in this clause apply to professional qualifications of staff of which the activities may affect the technical state of rolling stock and its use. Its application is mandatory in the context of rolling stock maintenance. Its application is recommended in the context of rolling stock operations.

The professional qualifications of staff required for the operation and maintenance of the

Infrastructure or



 <b>OTIF</b>	Uniform Technical Prescriptions <b>ACCESSIBILITY FOR PERSONS WITH DISABILITIES AND PERSONS WITH REDUCED MOBILITY</b>			UTP PRM Page 41 of 89
	Status: <b>PROPOSAL</b>	Version: 05	Ref.: A 94-05/1.2014	Original: EN
				Date: 28.03.2014

Rolling Stock Subsystems according to the technical scope as defined in point 1.1, and according to point 4.4 giving the list of operational rules, concerned by this

UTP, | TSI,

are as follows:

Professional training of staff performing the tasks of accompanying trains, delivering service and help for passengers at a station and of selling tickets shall include the subject of disability awareness and equality, including the specific needs of all persons with disabilities and persons with reduced mobility.

Professional training of engineers and managers, responsible for maintaining and operating

| the Infrastructure or

the Rolling Stock, shall include the subject of disability awareness and equality, including the specific needs of all persons with disabilities and persons with reduced mobility.

#### **4.7. HEALTH AND SAFETY CONDITIONS**

There is neither specific requirement in the scope of this

UTP | TSI

related to the health and safety conditions of staff required for the operation of the Infrastructure or Rolling Stock Subsystem nor for the implementation of the

UTP. | TSI.

#### **4.8. INFRASTRUCTURE AND ROLLING STOCK REGISTERS**

##### *4.8.1. Infrastructure register*

The characteristics of the infrastructure that must be recorded in the “register of railway infrastructure” are listed in Commission implementing decision 2011/633/EU<sup>11</sup>.

##### *4.8.2. Rolling Stock register*

The characteristics of the rolling stock that must be recorded in the “European register of authorised types of vehicles” are listed in Commission implementing decision 2011/665/EU<sup>12</sup>.

<sup>11</sup> Commission Implementing Decision 2011/633/EU of 15 September 2011 on the common specifications of the register of railway infrastructure (OJ L 256, 1.10.2011, p. 1–25).

<sup>12</sup> Commission Implementing Decision 2011/665/EU of 4 October 2011 on the European register of authorized types of railway vehicles (OJ L 264, 8.10.2011, p. 32–54).

 <b>OTIF</b>	Uniform Technical Prescriptions <b>ACCESSIBILITY FOR PERSONS WITH DISABILITIES AND PERSONS WITH REDUCED MOBILITY</b>			UTP PRM Page 42 of 89
	Status: <b>PROPOSAL</b>	Version: 05	Ref.: A 94-05/1.2014	Original: EN

## 5. INTEROPERABILITY CONSTITUENTS

### 5.1. DEFINITION

Elements of Construction or ‘interoperability constituents’ (ICs), are defined in Article 2(g) of ATMF.

According to Article 2(f) of Directive 2008/57/EC, “interoperability constituents” means any elementary component, group of components, subassembly or complete assembly of equipment incorporated or intended to be incorporated into a subsystem, upon which the interoperability of the rail system depends directly or indirectly.

The concept of a ‘constituent’ covers both tangible objects and intangible objects such as software.

An IC shall comply with the technical specifications of this chapter whether it is assessed separately as an IC or is assessed as an integrated part of a subsystem.

Assessment of IC separate from the subsystem is not mandatory in the COTIF regulations, but Contracting States or regional organizations<sup>13</sup> may require mandatory separate assessment according to the specification in sections 5.3 and 6.1 of this UTP.

Separate assessment of an IC:

If the IC is in conformity with this UTP, as evidenced by the manufacturer in the form of a declaration of conformity or suitability for use according to section 6.1 of this UTP and chapter 2 of UTP GEN-D, the IC shall be permitted to be used in accordance with its defined area of use, in accordance with section 5.3, in all Contracting States.

Assessment of an IC integrated into a vehicle:

If the IC is assessed as a part of the subsystem, the assessment procedures for subsystems apply. The requirements are identical to those if the IC were to be assessed separately, i.e. those set out in sections 5.3 and 6.1.

<sup>13</sup> In particular, compliance with EU law must be ensured when placing an IC on the market in the European Union.

 <b>OTIF</b>	Uniform Technical Prescriptions <b>ACCESSIBILITY FOR PERSONS WITH DISABILITIES AND PERSONS WITH REDUCED MOBILITY</b>			UTP PRM Page 43 of 89
	Status: <b>PROPOSAL</b>	Version: 05	Ref.: A 94-05/1.2014	Original: EN

## 5.2. INNOVATIVE SOLUTIONS

As stated in point 4.1 of this

UTP,

TSI,

innovative solutions may require new specification and / or new assessment methods. These specifications and assessment methods shall be developed by the process described in

Section 4.1 point 2) of this UTP.

(<sup>14</sup>) article 6 of the Regulation.

## 5.3. LIST AND CHARACTERISTICS OF CONSTITUENTS

The interoperability constituents are covered by the relevant provisions of

APTU and ATMF

Directive 2008/57/EC

and are listed below.

### 5.3.1. Infrastructure

The application of this UTP to infrastructure is not mandatory. Consequently, the application of this UTP is not mandatory for interoperability constituents for infrastructure either.

The following items are identified as being interoperability constituents for Infrastructure:

#### 5.3.1.1. Displays

- 1) Displays shall be sized to show individual station names or words of messages. Each station name, or words of messages, shall be displayed for a minimum of 2 seconds.
- 2) If a scrolling display is used (either horizontal or vertical), each complete word shall be displayed for a minimum of 2 seconds and the horizontal scrolling speed shall not exceed 6 characters per second.
- 3) Displays shall be designed and assessed for an area of use defined by the maximum viewing distance according to the following formula:  
Reading distance in mm divided by 250 = font size (for example: 10.000mm / 250 = 40mm).

<sup>14</sup> The provisions are set out in Article 6 of the Regulation enacting the PRM TSI.

 <b>OTIF</b>	Uniform Technical Prescriptions <b>ACCESSIBILITY FOR PERSONS WITH DISABILITIES AND PERSONS WITH REDUCED MOBILITY</b>			UTP PRM Page 44 of 89
	Status: <b>PROPOSAL</b>	Version: 05	Ref.: A 94-05/1.2014	Original: EN

#### 5.3.1.2. Platform ramps

- 1) Ramps shall be designed and assessed for an area of use defined by the maximum vertical gap they can overcome within a maximum slope of 18%.
- 2) Ramps shall accommodate a wheelchair with characteristics as detailed in appendix M.
- 3) Ramps shall withstand a weight of at least 300kg, placed at the centre of the device distributed over an area of 660mm by 660mm.
- 4) If the ramp is power operated it shall incorporate a method of manual operation should power fail.
- 5) The ramp surface shall be slip resistant and shall have an effective clear width of a minimum of 760mm.
- 6) Ramps having a clear width of less than 1000mm shall have raised edges on both sides to prevent mobility aid wheels from slipping off.
- 7) The upstands at both ends of the ramp shall be bevelled and shall not be higher than 20mm. They shall have contrasting hazard warning bands.
- 8) The ramp shall be equipped with a mechanism to securely locate the ramp so that it is not subject to displacement when in use for boarding or alighting.
- 9) The ramp shall be provided with self-contrasting markings.

#### 5.3.1.3. Platform lifts

- 1) Lifts shall be designed and assessed for an area of use defined by the maximum vertical gap they can overcome.
- 2) Lifts shall accommodate a wheelchair with characteristics as detailed in appendix M.
- 3) Lifts shall withstand a weight of at least 300kg, placed at the centre of the device distributed over an area of 660mm by 660mm.
- 4) The lift platform surface shall be slip resistant.
- 5) At surface level, the lift platform shall have a minimum clear width of 800mm and a length of 1200mm. According to appendix M, an additional length of 50 mm shall be available for feet above a height of 100 mm above the lift platform, considering both inboard and outboard orientations of the wheelchair user
- 6) The bridging plate overriding the gap between the lift platform and the carriage floor shall have a minimum width of 760mm.
- 7) Where provided, each control for deploying, lowering to ground level, raising and stowing the lift shall require continuous manual pressure by the operator and shall not allow an improper lift sequencing when the lift platform is occupied.
- 8) The lift shall incorporate a method of deploying, lowering to ground level with a lift occupant, and raising and stowing the empty lift if the power to the lift fails.
- 9) No part of the lift platform shall move at a rate exceeding 150mm/second during lowering and lifting an occupant, and shall not exceed 600mm/second during deploying or stowing (except if the lift is manually deployed or stowed).
- 10) The maximum lift platform horizontal and vertical acceleration when occupied shall be 0.3g.
- 11) The lift platform shall be equipped with barriers to prevent any of the wheels of a wheelchair from rolling off the lift platform during its operation.

 <b>OTIF</b>	Uniform Technical Prescriptions <b>ACCESSIBILITY FOR PERSONS WITH DISABILITIES AND PERSONS WITH REDUCED MOBILITY</b>			UTP PRM Page 45 of 89
	Status: <b>PROPOSAL</b>	Version: 05	Ref.: A 94-05/1.2014	Original: EN

- 12) A movable barrier or inherent design feature shall prevent a wheelchair from rolling off the edge closest to the vehicle until the lift is in its fully raised position.
- 13) Each side of the lift platform which extends beyond the vehicle in its raised position shall have a barrier a minimum 25mm high. Such barriers shall not interfere with manoeuvring into or out of the aisle.
- 14) The loading-edge barrier (outer barrier) which functions as a loading ramp when the lift is at ground level, shall be sufficient when raised or closed, or a supplementary system shall be provided, to prevent a power wheelchair from riding over or defeating it.
- 15) The lift shall permit both inboard and outboard orientation of the wheelchair user.
- 16) The lift shall be provided with self-contrasting markings.

### 5.3.2. *Rolling stock*

The following items are identified as being interoperability constituents for Rolling Stock:

#### 5.3.2.1. Interface of the door control device

- 1) A door control device shall have visual indication, on or around it when enabled and shall be operable by the palm of the hand exerting a force not greater than 15N.
- 2) It shall be identifiable by touch (for example: tactile markings); this identification shall indicate the functionality.

#### 5.3.2.2. Standard and universal toilets: common parameters

- 1) The centre of any door handle, lock or door control device on the exterior or interior of the toilet compartment shall be located at a minimum of 800mm and a maximum of 1100mm above the toilet door threshold.
- 2) A visual and tactile (or audible) indication shall be given inside and outside the toilet to indicate when a door has been locked.
- 3) Any door control device and other equipment inside the toilet compartment (except for baby nappy change facilities and call for aid devices) shall be operable by exerting a force not exceeding 20N.
- 4) Any control device, including flushing system, shall contrast with the background surface, and shall be identifiable by touch.
- 5) Clear, precise information for the operation of any control device shall be provided, making use of pictograms and shall be tactile.
- 6) The toilet seat and lid, and any handrails shall contrast with the background.

#### 5.3.2.3. Standard toilet

- 1) A standard toilet is not designed to be accessible to a wheelchair user.
- 2) The minimum door useable width shall be 500mm.
- 3) A fixed vertical and/or horizontal handrail according to point 4.2.2.9 shall be provided adjacent to the toilet seat and the wash basin.

 <b>OTIF</b>	Uniform Technical Prescriptions <b>ACCESSIBILITY FOR PERSONS WITH DISABILITIES AND PERSONS WITH REDUCED MOBILITY</b>			UTP PRM Page 46 of 89
	Status: <b>PROPOSAL</b>	Version: 05	Ref.: A 94-05/1.2014	Original: EN

#### 5.3.2.4. Universal toilet

- 1) A universal toilet is a toilet designed to be used by all passengers including all persons with disabilities and persons with reduced mobility.
- 2) The area of use of a universal toilet is defined by the method used for its assessment (A or B according to point 6.1.3.1)
- 3) The toilet access door shall provide a minimum clear useable width of 800mm. Where the door is automatic or semi-automatic, it shall be possible to open it partially in order to allow a wheelchair user's assistant to leave and re-enter the toilet module.
- 4) The exterior of the door shall be marked with a sign in accordance with appendix N.
- 5) There shall be sufficient space inside the toilet compartment to enable a wheelchair as defined in appendix M to be manoeuvred to a position allowing both a lateral and a diagonal transfer of the wheelchair occupant to the toilet seat.
- 6) There shall be a minimum clear space of 700mm in front of the toilet seat that shall follow the seat profile.
- 7) A horizontal handrail that complies with the requirements of point 4.2.2.9 shall be provided at each side of the toilet seat extending at least to the leading edge of the toilet seat.
- 8) The handrail on the wheelchair accessible side shall be hinged in such a way so as to enable an unobstructed transfer for the wheelchair user to and from the toilet seat.
- 9) The surface of the toilet seat, when lowered, shall be at a height of 450mm to 500mm above the floor level.
- 10) All amenities shall be readily accessible to a wheelchair user.
- 11) The toilet cubicle shall be fitted with not less than two call for aid devices that shall, when operated, send a signal to a person who can take appropriate action; they need not initiate a communication.
- 12) The interface of the call for aid devices shall be as defined in point 5.3.2.6.
- 13) One call for aid device shall be placed not more than 450mm above the floor, measured vertically from the surface of the floor to the centre of the control. It shall be positioned so that the control can be reached by a person lying on the floor.
- 14) The other call for aid device shall be not less than 800mm and not more than 1100mm above the floor, measured vertically to the centre of the control.
- 15) These two call for aid devices shall be located on different vertical surfaces of the cubicle so that they can be reached from a range of positions.
- 16) The control of the call for aid devices shall be distinct from any other control within the toilet, be coloured differently from other control devices and contrast with their background.
- 17) If a baby nappy changing table is provided, in the lowered position its usable surface shall be between 800mm and 1000mm above floor level.

#### 5.3.2.5. Baby nappy changing table

- 1) The usable surface of the baby nappy changing table shall be a minimum of 500mm wide and 700mm long.
- 2) It shall be designed to prevent a baby from inadvertently sliding off, shall have no sharp edges and shall be able to take a minimum load of 80 kg.

 <b>OTIF</b>	Uniform Technical Prescriptions <b>ACCESSIBILITY FOR PERSONS WITH DISABILITIES AND PERSONS WITH REDUCED MOBILITY</b>			UTP PRM Page 47 of 89
	Status: <b>PROPOSAL</b>	Version: 05	Ref.: A 94-05/1.2014	Original: EN

- 3) It shall be possible to put it into the stowed position with only one hand, using a force not exceeding 25N.

#### 5.3.2.6. Interface of the call for aid device

A call for aid device shall:

- 1) Be indicated by a sign having a green or yellow background (according to the specification referenced in appendix A, index 10) and a white symbol, representing a bell or a telephone; the sign can be on the button or bezel or on a separate pictogram,
- 2) Include tactile symbols,
- 3) Emit a visual and audible indication to the user that it has been operated
- 4) Provide additional operating information if necessary.
- 5) Be operable by the palm of a person's hand and not require a force exceeding 30N to operate.

#### 5.3.2.7. Internal and External Displays

- 1) Each station name (which may be abbreviated), or words of messages, shall be displayed for a minimum of 2 seconds.
- 2) If a scrolling display is used (either horizontal or vertical), each complete word shall be displayed for a minimum of 2 seconds and the horizontal scrolling speed shall not exceed an average of 6 characters per second.
- 3) The typeface used for texts shall be easily readable.
- 4) Upper Case Letters and numbers used in external displays shall have a minimum height of 70mm on front displays and 35mm on side displays.
- 5) Internal displays shall be designed and assessed for an area of use defined by the maximum viewing distance according to the following formula:

Reading distance	Height of upper case letters and numbers
< 8750mm	(reading distance / 250) mm
8750 to 10000 mm	35 mm
> 10000mm	(reading distance / 285) mm

Table 13: Area of use of the internal displays for Rolling Stock

#### 5.3.2.8. Boarding aids: movable steps and bridging plates

- 1) A movable step or bridging plate shall be designed and assessed for an area of use defined by the width of the doorway it can fit.
- 2) The mechanical strength of the device shall be according to the specification referenced in Appendix A, index 11.

 <b>OTIF</b>	Uniform Technical Prescriptions <b>ACCESSIBILITY FOR PERSONS WITH DISABILITIES AND PERSONS WITH REDUCED MOBILITY</b>			UTP PRM Page 48 of 89
	Status: <b>PROPOSAL</b>	Version: 05	Ref.: A 94-05/1.2014	Original: EN

- 3) A suitable mechanism shall be installed in order to ensure the stability of the device in the deployed and retracted position.
- 4) The device surface shall be slip resistant and shall have an effective clear width as large as the doorway width.
- 5) The device shall be equipped with obstacle detection according to the specification referenced in Appendix A, index 11.
- 6) The device shall incorporate a method of deploying and stowing if the power to the step fails.

#### 5.3.2.9. Boarding aids: on-board ramps

- 1) Ramps shall be designed and assessed for an area of use defined by the maximum vertical gap they can overcome within a maximum slope of 18%
- 2) Ramps shall withstand a weight of at least 300 kg, placed at the centre of the ramp distributed over an area of 660 mm by 660mm.
- 3) An access ramp shall be either positioned manually by staff or deployed semi-automatically by mechanical means, operated by staff or by the passenger.
- 4) If the ramp is power operated it shall incorporate a method of manual operation should power fail.
- 5) The ramp surface shall be slip resistant and shall have an effective clear width of a minimum of 760mm.
- 6) Ramps having a clear width of less than 1000mm shall have raised edges on both sides to prevent mobility aid wheels from slipping off.
- 7) The upstands at both ends of the ramp shall be bevelled and shall not be higher than 20mm. They shall have contrasting hazard warning bands.
- 8) When in use for boarding or alighting, the ramp shall be secured in use so that it is not subject to displacement when loading or unloading.
- 9) A semi-automatic ramp shall be fitted with a device capable of stopping the movement of that step if its front edge comes into contact with anything or person whilst the plate is in movement.
- 10) The ramp shall be provided with self-contrasting markings.

#### 5.3.2.10. Boarding aids: on-board lifts

- 1) Lifts shall be designed and assessed for an area of use defined by the maximum vertical gap they can overcome.
- 2) The lift platform surface shall be slip resistant. At surface level, the lift platform shall have a minimum clear width of 760mm and a length of 1200mm. According to appendix M, an additional length of 50 mm shall be available for feet above a height of 100 mm above the lift platform, considering both inboard and outboard orientations of the wheelchair user.
- 3) The bridging plate overriding the gap between the lift platform and the carriage floor shall have a minimum width of 720mm.
- 4) The lift shall withstand a weight of at least 300 kg, placed at the centre of the lift platform distributed over an area of 660mm by 660mm.



 <b>OTIF</b>	Uniform Technical Prescriptions <b>ACCESSIBILITY FOR PERSONS WITH DISABILITIES AND PERSONS WITH REDUCED MOBILITY</b>			UTP PRM Page 49 of 89
	Status: <b>PROPOSAL</b>	Version: 05	Ref.: A 94-05/1.2014	Original: EN

- 5) Where provided, each control for deploying, lowering to ground level, raising and stowing the lift shall require continuous manual pressure and shall not allow an improper lift sequencing when the lift platform is occupied.
- 6) The lift shall incorporate a method of deploying, lowering to ground level with a lift occupant, and raising and stowing the empty lift if the power to the lift fails.
- 7) No part of the lift platform shall move at a rate exceeding 150mm/second during lowering and lifting an occupant, and shall not exceed 600mm/second during deploying or stowing (except if the lift is manually deployed or stowed).
- 8) The maximum lift platform horizontal and vertical acceleration when occupied shall be 0.3g.
- 9) The lift platform shall be equipped with barriers to prevent any of the wheels of a wheelchair from rolling off the lift platform during its operation.
- 10) A movable barrier or inherent design feature shall prevent a wheelchair from rolling off the edge closest to the vehicle until the lift is in its fully raised position.
- 11) Each side of the lift platform which extends beyond the vehicle in its raised position shall have a barrier a minimum 25mm high. Such barriers shall not interfere with manoeuvring into or out of the aisle.
- 12) The loading-edge barrier (outer barrier) which functions as a loading ramp when the lift is at ground level, shall be sufficient when raised or closed, or a supplementary system shall be provided, to prevent a power wheelchair from riding over or defeating it.
- 13) The lift shall permit both inboard and outboard orientation of the wheelchair user.
- 14) The lift shall be provided with self-contrasting markings.

 <b>OTIF</b>	Uniform Technical Prescriptions <b>ACCESSIBILITY FOR PERSONS WITH DISABILITIES AND PERSONS WITH REDUCED MOBILITY</b>			UTP PRM Page 50 of 89
	Status: <b>PROPOSAL</b>	Version: 05	Ref.: A 94-05/1.2014	Original: EN

## 6. ASSESSMENT OF CONFORMITY AND/OR SUITABILITY FOR USE

Modules for the

assessment procedures for the verification of elements of construction are described in the UTP GEN-D<sup>15</sup>.

procedures for assessment of conformity, suitability for use and EC verification are described in the Commission Decision 2010/713/EU<sup>16</sup>.

### 6.1. ELEMENTS OF CONSTRUCTION INTEROPERABILITY CONSTITUENT (IC)

#### 6.1.1. *Conformity assessment*

In accordance with UTP GEN-D, Contracting States may require the mandatory separate assessment of ICs. If not required by the Contracting State, separate assessment of ICs may be carried out on a voluntary basis.

In the case of separate IC assessment, the manufacturer bears full responsibility for the UTP compliance of the product within its specified area of use.

In case of separate IC assessment, the assessment

An EC declaration of conformity or suitability for use, in accordance with Article 13(1) and Annex IV of Directive 2008/57/EC, shall be drawn up by the manufacturer or his authorised representative established in the Union before placing an interoperability constituent on the market.

The Conformity Assessment of an Interoperability Constituent

shall be according to the prescribed module(s) of that particular constituent specified in point 6.1.2 of this

UTP.

TSI.

#### 6.1.2. *Application of modules*

Assessment procedures (modules) for the verification of elements of construction.

are listed in the table below:

The modules for the EC certification of conformity of interoperability constituents

<sup>15</sup> Assessment procedures (modules)– General Provisions, UTP, APTU (A 94-01D/3.2011)

<sup>16</sup> Commission Decision 2010/713/EU of 9 November 2010 on modules for the procedures for assessment of conformity, suitability for use and EC verification to be used in the technical specifications for interoperability adopted under Directive 2008/57/EC of the European Parliament and of the Council (notified under document C(2010) 7582) (OJ L 319, 4.12.2010, p. 1–52)

 <b>OTIF</b>	Uniform Technical Prescriptions <b>ACCESSIBILITY FOR PERSONS WITH DISABILITIES AND PERSONS WITH REDUCED MOBILITY</b>			UTP PRM Page 51 of 89
	Status: <b>PROPOSAL</b>	Version: 05	Ref.: A 94-05/1.2014	Original: EN

Module CA	Internal production control	
Module CA1	Internal production control plus product verification by individual examination	
Module CA2	Internal production control plus product verification at random intervals	
Module CB	Type examination	EC-Type examination
Module CC	Conformity to type based on internal production control	
Module CD	Conformity to type based on quality management system of the production process	
Module CF	Conformity to type based on product verification	
Module CH	Conformity based on full quality management system	
Module CH1	Conformity based on full quality management system plus design examination	
Module CV	Type validation by in service experience (Suitability for use)	

Table 14: Assessment procedures (modules) for the verification of elements of construction.

Table 14: Modules for EC certification of conformity of interoperability constituents

In the case of separate IC assessment, the manufacturer

The manufacturer or his authorised representative established within the Union

shall choose one of the modules or module combinations indicated in the following table for the constituent to be assessed:

Point of this UTP/Annex	Constituents to be assessed	Module CA	Module CA1 or CA2* <sup>17</sup>	Module CB +CC	Module CB +CD	Module CB +CF	Module CH* <sup>18</sup>	Module CH1
5.3.1.1	Displays		X	X	X		X	X
5.3.1.2 and 5.3.1.3	Platform ramps and platform lifts		X		X	X	X	X
5.3.2.1	Interface of door control device	X		X			X	
5.3.2.2, 5.3.2.3 and 5.3.2.4	Toilet modules		X	X	X		X	X
5.3.2.5	Baby nappy changing table	X		X			X	
5.3.2.6	Call for aid devices	X		X			X	
5.3.2.7	Internal and external displays		X	X	X		X	X

<sup>17</sup> Modules CA1, CA2 or CH may be used only in the case of products manufactured according to a design developed and already used to place products on the market before the application of relevant UTPs applicable to those products, provided that the manufacturer demonstrates to the assessing entity that design review and type examination were performed for previous applications under comparable conditions, and are in conformity with the requirements of this UTP; this demonstration shall be documented, and is considered as providing the same level of proof as module CB or design examination according to module CH1.

 <b>OTIF</b>	Uniform Technical Prescriptions <b>ACCESSIBILITY FOR PERSONS WITH DISABILITIES AND PERSONS WITH REDUCED MOBILITY</b>			UTP PRM Page 52 of 89
	Status: <b>PROPOSAL</b>	Version: 05	Ref.: A 94-05/1.2014	Original: EN Date: 28.03.2014

Point of this UTP/Annex	Constituents to be assessed	Module CA	Module CA1 or CA2* <sup>17</sup>	Module CB +CC	Module CB +CD	Module CB +CF	Module CH* <sup>18</sup>	Module CH1
5.3.2.8 to 5.3.2.10	Boarding devices		X		X	X	X	X

Table 15: Combination of modules for

assessment procedures (modules) for the verification of elements of construction.

EC certification of conformity of interoperability constituents

(\* ) Modules CA1, CA2 or CH may be used only in the case of products manufactured according to a design developed and already used to place products on the market before the application of relevant TSIs applicable to those products, provided that the manufacturer demonstrates to the notified body that design review and type examination were performed for previous applications under comparable conditions, and are in conformity with the requirements of this TSI; this demonstration shall be documented, and is considered as providing the same level of proof as module CB or design examination according to module CH1.

Where a particular procedure shall be used for the assessment, this is specified in the point 6.1.3.

### 6.1.3. Particular assessment procedures

#### 6.1.3.1. Universal Toilet Module

The space inside the toilet compartment enabling a wheelchair as defined in appendix M to be manoeuvred to a position allowing both a lateral and a diagonal transfer of the wheelchair occupant to the toilet seat shall be assessed using the method A described in the specification referenced in Appendix A, index 9.

Alternatively, where method A cannot be used, it is allowed to utilize method B described in the specification referenced in Appendix A, index 9. This allowance is only provided for in the following cases:

- vehicles where the available floor width is narrower than 2400 mm,
- existing rolling stock when it is renewed or upgraded,

#### 6.1.3.2. Toilet Module and Universal Toilet Module

When a toilet module or a universal toilet module is not built as an independent compartment, its characteristics can be assessed at subsystem level.

 <b>OTIF</b>	Uniform Technical Prescriptions <b>ACCESSIBILITY FOR PERSONS WITH DISABILITIES AND PERSONS WITH REDUCED MOBILITY</b>			UTP PRM Page 53 of 89
	Status: <b>PROPOSAL</b>	Version: 05	Ref.: A 94-05/1.2014	Original: EN

## 6.2. SUBSYSTEMS

### 6.2.1. OTIF verification (general)

The OTIF procedure for granting technical certificates is set out in ATMF Article 10.

A Contracting State which is also a member of the European Union shall apply European law concerning EC Declarations of verification.

The UTP verification procedure

shall be performed according to the prescribed modules(s) specified in point 6.2.2 of this

UTP.

### EC verification (general)

The EC verification procedures to be applied to the subsystems are described in Article 18 and Annex VI of Directive 2008/57/EC.

The EC verification procedure

TSI.

For the infrastructure subsystem, if the applicant demonstrates that tests or assessments of a subsystem or parts of a subsystem are the same or have been successful for previous applications of a design, the

assessing entity

shall consider the results of these tests and assessments for the

OTIF verification

notified body

EC verification.

The approval process and the contents of the assessment shall be defined between the applicant and

assessing entity

according to the requirements defined in this

UTP

and in conformance with the rules set out in section 7 of this

UTP.

notified body

TSI

TSI.

### 6.2.2. Procedures for

*Assessment procedures for the verification of subsystems (modules)*

*EC verification of a subsystem*

 <b>OTIF</b>	Uniform Technical Prescriptions <b>ACCESSIBILITY FOR PERSONS WITH DISABILITIES AND PERSONS WITH REDUCED MOBILITY</b>			UTP PRM Page 54 of 89
	Status: <b>PROPOSAL</b>	Version: 05	Ref.: A 94-05/1.2014	Original: EN

(modules)

The modules for the

assessment procedures for the verification of subsystems are listed in the table below:

EC verification of subsystems are listed in the table below:

Module	OTIF Type examination	EC-type examination
Module SD	Quality management system of the production process	EC verification based on quality management system of the production process
Module SF	Verification based on product verification	EC verification based on product verification
Module SG <sup>18</sup>	reserved	EC verification based on unit verification
Module SH1	Verification based on full quality management system plus design examination	EC verification based on full quality management system plus design examination

Table 16: Modules for the

assessment procedures for the verification of subsystems

EC verification of subsystems

The applicant shall choose one of the modules or module combinations indicated in Table 18.

Subsystem to be assessed	Module SB+SD	Module SB+SF	Module SG	Module SH1
Rolling Stock Subsystem	X	X		X
Infrastructure Subsystem			X	X

Table 17: Combination of Modules for the

assessment procedures for the verification of subsystems

EC verification of subsystems

The characteristics of the subsystem to be assessed during the relevant phases are indicated in appendix E to this

UTP,

TSI,

Table E.1 for Infrastructure subsystem and Table E.2 for Rolling Stock subsystem. The applicant shall confirm that

<sup>18</sup> Application of this UTP for the infrastructure subsystem is voluntary so there is no module SG in COTIF describing the assessment procedure for the verification of infrastructure subsystem.

 <b>OTIF</b>	Uniform Technical Prescriptions <b>ACCESSIBILITY FOR PERSONS WITH DISABILITIES AND PERSONS WITH REDUCED MOBILITY</b>			UTP PRM Page 55 of 89
	Status: <b>PROPOSAL</b>	Version: 05	Ref.: A 94-05/1.2014	Original: EN

Rolling Stock subsystem (mandatory)  
and/or the Infrastructure subsystem  
(voluntary)

each subsystem

produced complies with the type.

### 6.2.3. Particular assessment procedures

#### 6.2.3.1. Wheelchair transfer seat

The assessment of the requirement for the provision of transfer seats shall only consist in verifying that they are present and equipped with movable armrests. In particular the method of transfer shall not be assessed.

#### 6.2.3.2. Step position for vehicle access and egress

This requirement shall be validated by calculation using the nominal values of the construction drawing of the vehicle and the nominal values of the relevant platform or platforms where the rolling stock is intended to stop. The outer end of the floor at the passenger access door shall be considered as a step.

### 6.2.4. Technical solutions giving presumption of conformity at design stage

With regard to this

UTP,

TSI,

the infrastructure subsystem can be considered as an assembly made of a succession of recurring subcomponents such as:

- Parking facilities,
- Doors and entrances, transparent obstacles with their marking
- Tactile walking surface indicators, tactile information along obstacle-free routes,
- Ramps and stairs with handrails
- Mounting and highlighting of furniture,
- Ticketing or information counters,
- Ticket vending and control machines,
- Visual information: signposting, pictograms, dynamic information
- Platforms, including ends and edges, shelters and waiting areas when provided
- Level track crossings,

For those subcomponents of the infrastructure subsystem, presumption of conformity may be assessed at design stage prior to and independently from any specific project. An intermediate statement of verification (ISV) shall be issued by a Notified Body at design stage.

 <b>OTIF</b>	Uniform Technical Prescriptions <b>ACCESSIBILITY FOR PERSONS WITH DISABILITIES AND PERSONS WITH REDUCED MOBILITY</b>			UTP PRM Page 56 of 89
	Status: <b>PROPOSAL</b>	Version: 05	Ref.: A 94-05/1.2014	Original: EN

#### 6.2.5. *Assessment of maintenance*

The Assessing Entity

According to Article 18 (3) of Directive 2008/57/EC, a notified body

shall be responsible for compiling the technical file, containing the documentation requested for operation and maintenance.

The Assessing Entity

The Notified Body

shall verify only that the documentation requested for operation and maintenance, as defined in point 4.5 of this

UTP, is provided. The Assessing Entity

TSI, is provided. The Notified Body

is not required to verify the information contained in the documentation provided.

#### 6.2.6. *Assessment of operational rules*

The railway undertaking is responsible for the safe operation of its trains (ATMF Article 6§2), i.e. it shall ensure that all safety-related on-train equipment is in a fully functional state and that the train is safe to run.

In conformity with Articles 10 and 11 of Directive 2004/49/EC, railway undertakings and infrastructure managers must demonstrate compliance with the operational requirements of this TSI within their safety management system when applying for any new or amended safety certificate or safety authorisation.

The rail transport undertaking shall control the risks associated with the use of the vehicles. Operating rules covering the activities and measures, set out in Appendix L of the UTP LOC & PAS – Provisions for the safe operation of rolling stock<sup>19</sup>, shall be established<sup>20</sup>.

For the purpose of this

UTP, the Assessing Entity

TSI, the Notified Body

shall not verify any operational rule, even if they are listed in point 4. 4.

#### 6.2.7. *Assessment of units intended to be used in general operation*

When Rolling Stock is supplied as individual vehicles, rather than in fixed units, such vehicles shall be assessed against the relevant points of this

UTP,

TSI,

accepting that not every such vehicle will have wheelchair spaces, wheelchair accessible facilities or a universal toilet.

<sup>19</sup> The provisions in appendix L relate to the correct operation of rolling stock within its conditions and limits of use. It is anticipated that Appendix L will be repealed when a UTP OPE enters into force.

<sup>20</sup> Unlike EU law, where the RU is responsible, OTIF law does not specify who should establish these operating rules.



 <b>OTIF</b>	Uniform Technical Prescriptions <b>ACCESSIBILITY FOR PERSONS WITH DISABILITIES AND          PERSONS WITH REDUCED MOBILITY</b>			UTP PRM Page 57 of 89
	Status: <b>PROPOSAL</b>	Version: 05	Ref.: A 94-05/1.2014	Original: EN

The area of use in terms of type of Rolling stock which, coupled with the unit to be assessed, ensures that the train is fully compliant with the

UTP is not verified by the Assessing Entity.

TSI is not verified by the Notified Body

After such a unit has received the authorisation to be placed in service, it is the responsibility of the Railway Undertaking to make sure, when forming the train with other compatible vehicles, that point 4.2 of this

UTP

TSI

is complied with at train level, according to the rules defined in

Appendix L of the UTP LOC & PAS – Provisions for the safe operation of rolling stock (train composition).

point 4.2.2.5 of the OPE TSI (train composition).

 <b>OTIF</b>	Uniform Technical Prescriptions <b>ACCESSIBILITY FOR PERSONS WITH DISABILITIES AND PERSONS WITH REDUCED MOBILITY</b>			UTP PRM Page 58 of 89
	Status: <b>PROPOSAL</b>	Version: 05	Ref.: A 94-05/1.2014	Original: EN

## 7. IMPLEMENTATION OF THE UTP/TSI

### 7.1. APPLICATION OF THIS UTP/TSI TO NEW INFRASTRUCTURE AND ROLLING STOCK

#### 7.1.1. *New Infrastructure*

The application of infrastructure related parameters of this UTP is voluntary, but is recommended.

This

UTP

TSI

is applicable to all new stations in its scope.

This

UTP

TSI

does not apply to new stations which have already been granted a building permit or which are subject to a contract for construction works that is either already signed or under final phase of tendering procedure at the date of application of this

UTP.

TSI. Anyhow, in such cases, PRM TSI 2008<sup>21</sup> has to be applied within its defined scope. For those station projects, where PRM TSI 2008 will have to be applied, it is permissible (but not mandatory) to use the revised version, either totally or for particular sections; in case of application limited to particular sections, the applicant has to justify and document that applicable requirements remain consistent, and this has to be approved by the notified body.

Where stations which were closed for a long time to passenger service are put in service again, this may be treated as renewal or upgrade according to point 7.2.

In all cases of construction of a new station, the Station Manager should organise consultation with the entities in charge of the management of the neighbourhood, in order to enable the accessibility requirements to be met not only in the station, but also for access to the station. In the case of multimodal stations, other transport authorities should also be consulted for access to and from the railway and other modes of transport.

#### 7.1.2. *New Rolling Stock*

This UTP is applicable to all units of rolling stock in its scope for which the

This TSI is applicable to all units of rolling stock in its scope which are placed in service

<sup>21</sup> Commission Decision of 21 December 2007 concerning the technical specification of interoperability relating to 'persons with reduced mobility' in the trans-European conventional and high-speed rail system (OJ L 64, 7.3.2008, p. 72).

 <b>OTIF</b>	Uniform Technical Prescriptions <b>ACCESSIBILITY FOR PERSONS WITH DISABILITIES AND PERSONS WITH REDUCED MOBILITY</b>			UTP PRM Page 59 of 89
	Status: <b>PROPOSAL</b>	Version: 05	Ref.: A 94-05/1.2014	Original: EN

UTP LOC&PAS applies.

after the date of application of this TSI, except where the points 7.1.1.2 “Transition phase” and 7.1.3.1 (“Rolling stock subsystem”) of the LOC&PAS TSI apply.

## **7.2. APPLICATION OF THIS UTP/TSI TO EXISTING INFRASTRUCTURE AND ROLLING STOCK**

### *7.2.1. Steps of the gradual transition to the target system*

This

UTP applies to rolling stock units

TSI applies to subsystems

when they are renewed or upgraded.

This

UTP is not mandatory for the infrastructure subsystem and even when applied

TSI

does not apply to renewed or upgraded stations which have already been granted a building permit or which are subject to a contract for construction works that is either already signed or under final phase of tendering procedure at the date of application of this

UTP.

TSI.

This

UTP

TSI

does not apply to renewed or upgraded rolling stock which are subject to a contract already signed or under final phase of tendering procedure at the date of application of this

UTP. If Contracting States apply it on a voluntary basis for the infrastructure subsystem, for

TSI. For

the existing infrastructure and Rolling Stock, the overarching aim of the

UTP

TSI

is to achieve compliance with the

UTP

TSI

through the identification and progressive elimination of existing obstacles to accessibility.

Member States ensure that inventories of assets are organized and adopt implementation plans in order

 <b>OTIF</b>	Uniform Technical Prescriptions <b>ACCESSIBILITY FOR PERSONS WITH DISABILITIES AND PERSONS WITH REDUCED MOBILITY</b>			UTP PRM Page 60 of 89
	Status: <b>PROPOSAL</b>	Version: 05	Ref.: A 94-05/1.2014	Original: EN

to achieve the aim of this Regulation.

### 7.2.2. *Application of this*

*UTP*

*TSI*

*to existing Infrastructure*

For Infrastructure, the conformity with this

UTP is voluntary

TSI is mandatory

for those parts that are renewed or upgraded. However, the

UTP

TSI

recognizes that, due to the characteristics of the inherited Railway system, compliance of existing infrastructure may be achieved through a gradual improvement of accessibility.

In addition to this gradual approach, the target system for existing infrastructure permits the following exceptions:

- In case an obstacle free route is created from existing footbridges, stairways and subways, including doors, lifts and ticket control machines, compliance with requirements related to dimensions of those in respect of width is not mandatory.
- Compliance with requirements related to the minimum width of the platform is not mandatory for existing stations if the cause of non-compliance is the presence of certain platform obstacles (e.g. structural columns, stairwells, lifts etc.) or existing tracks that are unlikely to be moveable.
- Where an existing station, or a part of it, is a recognised historic building and is protected by National Law, it is allowed to adapt the requirements of this

UTP

TSI

in order not to infringe the National law for the protection of the building.

### 7.2.3. *Application of this*

*UTP*

*TSI*

*to existing Rolling Stock*

For Rolling Stock, the conformity with this

UTP,

TSI,

for those parts that are renewed or upgraded, shall be as described in appendix F.

 <b>OTIF</b>	Uniform Technical Prescriptions <b>ACCESSIBILITY FOR PERSONS WITH DISABILITIES AND PERSONS WITH REDUCED MOBILITY</b>			UTP PRM Page 61 of 89
	Status: <b>PROPOSAL</b>	Version: 05	Ref.: A 94-05/1.2014	Original: EN

### 7.3. SPECIFIC CASES

#### 7.3.1. General

The specific cases, as listed in point 7.3.2, describe special provisions that are needed and authorised on particular networks of each

Contracting State.

The specific cases for Member States of the European Union are those which are included in the TSI PRM.

Member State.

These specific cases are classified as:

- “P” cases: “permanent” cases.
- “T” cases: “temporary” cases, where it is planned that the target system is reached in the future.

#### 7.3.2. List of specific cases

##### 7.3.2.1. Step position for vehicle access and egress (4.2.2.11) and boarding aids (4.2.2.12)

#### **Specific Case Switzerland (“P”)**

Rolling stock that is operated in Switzerland shall in principle be equipped with at least one door with boarding aids permitting independent access and egress for persons in wheelchairs or with wheeled walkers to and from vehicles (e.g. movable steps or bridging plates respecting the max. horizontal and vertical gap values) from the Swiss standard platform height (550 mm over rail level).

Explanation:

Ensuring autonomy for PRM is an overarching objective of Swiss national legislation<sup>22</sup>. For this, the access and egress to/from public transport vehicles shall in principle be ensured without assistance from company staff. Thus, rolling stock that is operated in Switzerland shall be equipped with at least one door with boarding aids permitting independent access and egress for persons in wheelchairs or with wheeled walkers to/from the vehicles (e.g. movable steps or bridging plates respecting the max. horizontal and vertical gap values) from the Swiss standard platform height (550 mm over rail level).

Exceptions to this rule must be dealt with within the proportionality clause, which is also in the DDA. When such an exception is approved by the Swiss Federal Office of Transport (FOT), assistance from company staff (and technical aid, e.g. on board or platform-based lifts) is necessary and is treated as a compensating measure.

<sup>22</sup> Federal Act on the Elimination of Discrimination against People with Disabilities, DDA, SR 151.3, <http://www.admin.ch/bundesrecht/00566/index.html?lang=de>

 <b>OTIF</b>	Uniform Technical Prescriptions <b>ACCESSIBILITY FOR PERSONS WITH DISABILITIES AND PERSONS WITH REDUCED MOBILITY</b>			UTP PRM Page 62 of 89
	Status: <b>PROPOSAL</b>	Version: 05	Ref.: A 94-05/1.2014	Original: EN
Date: 28.03.2014				

### **Appendix A: Standards or Normative Documents Referred to in this UTP / TSI**

Index	UTP / TSI		Normative document	
	Characteristics to be assessed	Point of this Annex	Document N°	Mandatory provisions
1	Dimensions of the lifts Tactile signage	4.2.1.2.2 4.2.1.10	EN 81-70:2003+A1:2004	Point 5.3.1, table 1 Annex E.4
2	Design of escalators and moving walks	4.2.1.2.2	EN 115-1:2008+A1:2010	
3	Lighting on platforms	4.2.1.9	EN 12464-2:2014	Table 5.12, except ref. no 5.12.16 and 5.12.19
4	Lighting on platforms	4.2.1.9	EN 12464-1:2011	Point 5.53.1
5	Speech transmission index, stations and rolling stock	4.2.1.11 4.2.2.7.4	EN 60268-16:2011	Annex B
6	Lighting in rolling stock	4.2.2.4	EN 13272:2012	Point 4.1.2
7	Safety, warning, mandatory action and prohibition signs	4.2.2.7.2	ISO 3864-1:2011	All
8	Calculation of $bq_0$	4.2.2.11.1	EN 15273-1:2013	Point H.2.1.1
9	Assessment of the Universal Toilet Module	6.1.3.1	TS 16635:2014	All
10	Definition of colours	5.3.2.6	ISO 3864-1:2011 ISO 3864-4:2011	Chapter 11
11	Boarding device mechanical strength Obstacle detection	5.3.2.8 5.3.2.8	EN 14752:2014	Point 4.2.2 Point 5.4
12	Symbol for sign which identify wheelchair accessible areas	Appendix N N.3	ISO 7000:2004 ISO 7001:2008	Symbol 0100 symbol PIPF 006
13	Symbol for sign indicating inductive loops	Appendix N N.3	ETSI EN 301 462 (2000-03)	4.3.1.2
14	Specific case for Finland	7.3.2.6	EN 15273-2:2013	Annex F

 <b>OTIF</b>	Uniform Technical Prescriptions <b>ACCESSIBILITY FOR PERSONS WITH DISABILITIES AND          PERSONS WITH REDUCED MOBILITY</b>			UTP PRM Page 63 of 89
	Status: <b>PROPOSAL</b>	Version: 05	Ref.: A 94-05/1.2014	Original: EN

## APPENDIX B: TEMPORARY PRIORITIZATION RULE FOR THE UPGRADE / RENEWAL OF STATIONS

[reserved]

When renewed or upgraded, existing stations that have a daily passenger flow of 1000 passengers or less, combined embarking and disembarking, averaged over a 12 month period are not required to have lifts or ramps where these would otherwise be necessary to provide a step free route if another station within 50 km on the same route provides a fully compliant obstacle-free route. In such circumstances the design of stations shall incorporate provision for the future installation of a lift and/or ramps to make the station accessible to all persons with disabilities and persons with reduced mobility. National Rules shall be applied for organising the transport of persons with disabilities and persons with reduced mobility by an accessible means between this non accessible station and the next accessible station on the same route.

 <b>OTIF</b>	Uniform Technical Prescriptions <b>ACCESSIBILITY FOR PERSONS WITH DISABILITIES AND PERSONS WITH REDUCED MOBILITY</b>			UTP PRM Page 64 of 89
	Status: <b>PROPOSAL</b>	Version: 05	Ref.: A 94-05/1.2014	Original: EN

## APPENDIX C: INFORMATION TO BE PROVIDED IN A NATIONAL IMPLEMENTATION PLAN

[reserved]

### Context

- Setting the scene (facts and figures – social data - evolution of mobility needs and mobility impairments)
- Legislative background
- Methodology for the elaboration of the NIP (associations consulted, local transport authorities consulted, interface with other NIPs, etc...)

### Current situation

- Overview of the inventories: stations
- Overview of the inventories: rolling stock
- Overview of the inventories: operational rules

### Definition of a strategy

- Prioritization rule,
- Criteria according to which subsystems are treated in the Plan.

### Technical and operational means

- Extent of the upgrade or renewal of stations and rolling stock
- All other works aimed at eliminating barriers to accessibility which are outside the scope of Article 20 of Directive 2008/57/EC
- Deployment of operational measures (assistance) to compensate the remaining lack of accessibility

### Financing

- Cross-references to contract agreements (Directive 2012/34/EU art. 30<sup>23</sup>) and public service contracts (Regulation (EC) N°1370/2007<sup>24</sup>)
- Other resources

### Follow-up and feedback

<sup>23</sup> Directive 2012/34/EU of the European Parliament and of the Council of 21 November 2012 establishing a single European railway area (OJ L 342, 14.12.2012, p. 32).

<sup>24</sup> Regulation (EC) No 1370/2007 of the European Parliament and of the Council of 23 October 2007 on public passenger transport services by rail and by road and repealing Council Regulations (EEC) No 1191/69 and 1107/70 (OJ L 315, 3.12.2007, p. 1).



 <b>OTIF</b>	Uniform Technical Prescriptions <b>ACCESSIBILITY FOR PERSONS WITH DISABILITIES AND  PERSONS WITH REDUCED MOBILITY</b>			UTP PRM Page 65 of 89
Status: <b>PROPOSAL</b>	Version: 05	Ref.: A 94-05/1.2014	Original: EN	Date: 28.03.2014

- Update of the inventory of assets and comparison with the objectives
- Update of the plan.

 <b>OTIF</b>	Uniform Technical Prescriptions <b>ACCESSIBILITY FOR PERSONS WITH DISABILITIES AND PERSONS WITH REDUCED MOBILITY</b>			UTP PRM Page 66 of 89
	Status: <b>PROPOSAL</b>	Version: 05	Ref.: A 94-05/1.2014	Original: EN
Date: 28.03.2014				

## APPENDIX D: ASSESSMENT OF INTEROPERABILITY CONSTITUENTS

### D.1 SCOPE

This Appendix indicates the assessment of conformity and suitability for use for interoperability constituents.

### D.2 CHARACTERISTICS

The characteristics of the interoperability constituents to be assessed in the different phases of design, development and production are marked by X in Table D.1.

Table D.1 – Assessment of Interoperability Constituents.

1	2	3	4	5
Interoperability Constituents and characteristics to be assessed	Assessment in the following phase			
	Design and development phase			Production phase
	Design review and /or Design examination	Review of manufacturing process	Type test	Verification of conformity to type
5.3.1.1 Displays	X		X	X
5.3.1.2 Platform ramps	X		X	X
5.3.1.3 Platform lifts	X		X	X
5.3.2.1 Interface of the door control device	X		X	X
5.3.2.2 & 5.3.2.3 Standard toilets	X		X	X
5.3.2.2 & 5.3.2.4 Universal toilets	X		X	X
5.3.2.5 Baby nappy changing unit	X		X	X
5.3.2.6 Call for aid device	X		X	X
5.3.2.7 Displays	X		X	X
5.3.2.8 Movable step and bridging plate	X		X	X
5.3.2.9 On-board ramp	X		X	X

 <b>OTIF</b>	Uniform Technical Prescriptions <b>ACCESSIBILITY FOR PERSONS WITH DISABILITIES AND          PERSONS WITH REDUCED MOBILITY</b>			UTP PRM Page 67 of 89
	Status: <b>PROPOSAL</b>	Version: 05	Ref.: A 94-05/1.2014	Original: EN

1	2	3	4	5
Interoperability Constituents and characteristics to be assessed	Assessment in the following phase			
	Design and development phase			Production phase
	Design review and /or Design examination	Review of manufacturing process	Type test	Verification of conformity to type
5.3.2.10 On-board lift	X		X	X

 <b>OTIF</b>	Uniform Technical Prescriptions <b>ACCESSIBILITY FOR PERSONS WITH DISABILITIES AND PERSONS WITH REDUCED MOBILITY</b>			UTP PRM Page 68 of 89
	Status: <b>PROPOSAL</b>	Version: 05	Ref.: A 94-05/1.2014	Original: EN

## APPENDIX E: ASSESSMENT OF THE SUBSYSTEMS

### E.1 SCOPE

This Appendix indicates the assessment of conformity of the subsystems.

### E.2 CHARACTERISTICS AND MODULES

The sub-system characteristics to be assessed in the different phases of design, development and production are marked by X in Table E.1 for Infrastructure subsystem and Table E.2 for Rolling Stock subsystem.

Table E.1 – Assessment of the Infrastructure subsystem (constructed and supplied as single entity)

1	2	3
Characteristics to be assessed	Design and development phase	Construction phase
	Design review and/or design examination	Site Inspection
Parking facilities for PRM	X	(X)*
Obstacle-free routes	X	(X)*
Route identification	X	(X)*
Doors and entrances	X	(X)*
Floor surfaces	X	(X)*
Transparent obstacles	X	(X)*
Toilets	X	(X)*
Furniture and free-standing devices	X	(X)*
Ticketing / Counter or vending machine / Information counter / Ticket control machine / Turnstiles / Customer Assistance points	X	(X)*
Lighting	X	X
Visual information: signposting, pictograms, dynamic information	X	(X)*
Spoken information	X	X
Platform width and edge of platform	X	(X)*
End of platform	X	(X)*
Level track crossing at stations	X	(X)*

\*: As-built drawings shall be provided or a site inspection shall be carried out when the realization differs from the design rules or drawings that were examined.

Table E.2 – Assessment of the Rolling Stock subsystem (constructed and supplied as serial products)

**OTIF**
 Uniform Technical Prescriptions  
**ACCESSIBILITY FOR PERSONS WITH DISABILITIES AND  
 PERSONS WITH REDUCED MOBILITY**

 UTP PRM  
 Page 69 of 89
Status: **PROPOSAL**

Version: 05

Ref.: A 94-05/1.2014

Original: EN

Date: 28.03.2014

1	2	3	4
Characteristics to be assessed	Design and development phase		Production phase
	Design review and/or design examination	Type Test	Routine Test
Seats			
General	X	X	
Priority Seats General	X		
Uni-directional seats	X	X	
Facing seats arrangement	X	X	
Wheelchair spaces	X	X	
Doors			
General	X	X	
Exterior doors	X	X	
Interior doors	X	X	
Lighting		X	
Toilets	X		
Clearways	X		
Customer Information			
General	X	X	
Signage, pictogram and tactile information	X	X	
Dynamic visual information	X	X	
Dynamic Audible information	X	X	
Height changes	X		
Handrails	X	X	
Wheelchair Accessible sleeping accommodation	X	X	
Step position for vehicle access and egress			
General requirements	X		
Access/egress steps	X		

 <b>OTIF</b>	Uniform Technical Prescriptions <b>ACCESSIBILITY FOR PERSONS WITH DISABILITIES AND          PERSONS WITH REDUCED MOBILITY</b>			UTP PRM Page 70 of 89
	Status: <b>PROPOSAL</b>	Version: 05	Ref.: A 94-05/1.2014	Original: EN

1	2	3	4
<b>Characteristics to be assessed</b>	<b>Design and development phase</b>		<b>Production phase</b>
	<b>Design review and/or design examination</b>	<b>Type Test</b>	<b>Routine Test</b>
Boarding aids	X	X	X

 <b>OTIF</b>	Uniform Technical Prescriptions <b>ACCESSIBILITY FOR PERSONS WITH DISABILITIES AND          PERSONS WITH REDUCED MOBILITY</b>			UTP PRM Page 71 of 89
	Status: <b>PROPOSAL</b>	Version: 05	Ref.: A 94-05/1.2014	Original: EN

## **APPENDIX F: RENEWAL OR UPGRADE OF ROLLING STOCK**

Where rolling stock is renewed or upgraded, it shall comply with the requirements of this

UTP;	TSI;
compliance with the content of this	

UTP	TSI
-----	-----

is not mandatory in the following cases:

### Structures

Compliance is not mandatory if the work would require structural alterations to door portals (interior or external), underframes, collision pillars, vehicle bodies, vehicle over-ride protection, or more generally is the work would necessitate re-validation of the vehicle structural integrity.

### Seats

Compliance with point 4.2.2.1 with regard to seat back grab handles is only mandatory if the seat structures are renewed or upgraded within an entire vehicle.

Compliance with point 4.2.2.1.2 with regard to the dimensions of priority seats and around is only mandatory if the seating layout is altered within an entire train and this can be achieved without reducing the existing capacity of the train. In the last circumstance the maximum number of priority seats shall be provided, whilst maintaining existing capacity.

Compliance with requirements regarding headroom above priority seating is not mandatory if the limiting factor is a luggage rack that is not being structurally altered during the renewal or upgrading work.

### Wheelchair Spaces

The provision of wheelchair spaces is only required when the seating layout is altered within a complete train formation. However, if the entrance doorway, or clearways, cannot be modified to enable wheelchair access, a wheelchair space needs not be provided if the seating layout is altered. Wheelchair spaces created in an existing rolling stock are permitted to be arranged according to Appendix I, figure I4.

The provision of call for aid devices at the wheelchair positions is not mandatory if the vehicle does not have an electrical communications system that can be adapted to include such a device.

The provision of a transfer seat is only mandatory when it does not require modifying the layout of an existing wheelchair space.

### Exterior doors

Compliance with requirements to define the interior position of external doorways by contrast at floor level is only mandatory when the floor covering is renewed or upgraded.

Compliance with requirements to provide door opening and closing signals is only mandatory when the door control system is renewed or upgraded.

Full compliance with requirements regarding the position and illumination of door controls is only mandatory when the door control system is renewed or upgraded and when the controls can be re-positioned

 <b>OTIF</b>	Uniform Technical Prescriptions <b>ACCESSIBILITY FOR PERSONS WITH DISABILITIES AND PERSONS WITH REDUCED MOBILITY</b>			UTP PRM Page 72 of 89
	Status: <b>PROPOSAL</b>	Version: 05	Ref.: A 94-05/1.2014	Original: EN
Date: 28.03.2014				

without alteration to the vehicle structure or door. However, in such an event, the renewed or upgraded controls shall be installed as close as possible to the compliant position.

### Interior doors

Compliance with the requirements for door control operation operating forces and positioning is only mandatory if the door and door mechanism and/or control is being upgraded or renewed.

### Lighting

Compliance with the requirement is not required if it can be established that there is insufficient capacity in the electrical system to support additional load, or that such lighting cannot locally be accommodated without structural alterations (doorways, etc...).

### Toilets

Provision of a fully compliant universal toilet is only mandatory when existing toilets are being completely renewed or upgraded and a wheelchair space is provided and a compliant universal toilet can be accommodated without structural alteration to the vehicle body.

The provision of call for aid devices in the universal toilet is not mandatory if the vehicle does not have an electrical communications system that can be adapted to include such a device.

### Clearways

Compliance with the requirements of point 4.2.2.6 is only mandatory if the seating layout is altered within an entire vehicle and a wheelchair space is being provided.

Compliance with the requirements for clearways between connecting vehicles is only mandatory if the gangway is being renewed or upgraded.

### Information

Compliance with the requirements of point 4.2.2.7 in respect of route information is not mandatory at renewal or upgrade. However, where an automated route information system is installed as part of a renewal or upgrade programme, it shall comply with the requirements of this point.

Compliance with the other parts of point 4.2.2.7 shall be mandatory whenever signage or interior finishes are renewed or upgraded.

### Height Changes

Compliance with the requirements of point 4.2.2.8 is not mandatory at renewal or upgrade, with the exception that a contrasting warning band on step nosings shall be provided when tread surface materials are renewed or upgraded.

### Handrails

Compliance with the requirements of point 4.2.2.9 is only mandatory where existing handrails are being renewed or upgraded.

### Wheelchair Accessible sleeping accommodation



 <b>OTIF</b>	Uniform Technical Prescriptions <b>ACCESSIBILITY FOR PERSONS WITH DISABILITIES AND          PERSONS WITH REDUCED MOBILITY</b>			UTP PRM Page 73 of 89
	Status: <b>PROPOSAL</b>	Version: 05	Ref.: A 94-05/1.2014	Original: EN

Compliance with the requirement to provide Wheelchair Accessible sleeping accommodation is only mandatory when existing sleeping accommodation is being renewed or upgraded.

The provision of call for aid devices in the Wheelchair Accessible sleeping accommodation is not mandatory if the vehicle does not have an electrical communications system that can be adapted to include such a device.

#### Step positions, steps and boarding aids

Compliance with the requirements of points 4.2.2.11 and 4.2.2.12 is not mandatory at renewal or upgrade, with the exception that if moveable steps or other integral boarding aids are fitted, they shall comply with the relevant sub-clauses in this point of the

UTP.

TSI.

However, if a wheelchair space in accordance with point 4.2.2.3 is created at renewal or upgrade, then it shall be mandatory to provide some form of boarding aid in accordance with point 4.4.3.

 <b>OTIF</b>	Uniform Technical Prescriptions <b>ACCESSIBILITY FOR PERSONS WITH DISABILITIES AND PERSONS WITH REDUCED MOBILITY</b>			UTP PRM Page 74 of 89
	Status: <b>PROPOSAL</b>	Version: 05	Ref.: A 94-05/1.2014	Original: EN
Date: 28.03.2014				

## APPENDIX G: PASSENGER EXTERNAL DOORS AUDIBLE WARNINGS

### Door opening - Characteristics

A slow pulse multi tone (up to 2 pulses per second) of 2 tones emitted sequential.

Frequencies

- 2200Hz +/- 100 Hz

and:

- 1760 Hz +/- 100 Hz

Sound Pressure level

- To be provided by either:
  - an adaptive audible warning device set at 5dB  $L_{Aeq}$  min above ambient up to a max of 70dB  $L_{Aeq,T}$  (+ 6/- 0)
  - or a non-adaptive device set at 70dB  $L_{Aeq,T}$  (+ 6/- 0)
- Internal measurement on the centre point of the vestibule at a height of 1.5m above the floor level. (T = total duration of the sound event) using measurement array (horizontal and then vertical) and averaged readings.
- External measurement, 1.5m away from the body side door centreline at 1.5m above the platform level. (T = total duration of the sound event) using measurement array (horizontal) and averaged readings.

### Door close - Characteristic

A fast pulsed tone (6-10 pulses per second)

Frequency

- 1 900 Hz +/- 100 Hz

Sound Pressure level

- To be provided by either:
  - an adaptive audible warning device set at 5dB  $L_{Aeq}$  min above ambient up to a max of 70dB  $L_{Aeq,T}$  (+ 6/- 0)
  - or a non-adaptive device set at 70dB  $L_{Aeq,T}$  (+ 6/- 0)
- Internal measurement on the centre point of the vestibule at a height of 1.5m above the floor level. (T = total duration of the sound event) using measurement halo (horizontal and then vertical) and averaged readings.
- External measurement, 1.5m away from the body side door centreline at 1.5m above the platform level. (T = total duration of the sound event) using measurement halo (horizontal) and averaged readings.

### Internal measurement method for Passenger door audible warnings (Open and Close)

Tests to be carried out in the vestibule using an averaged reading from a multiple microphone array (designed for measuring horn noise in the cab in accordance with

 <b>OTIF</b>	Uniform Technical Prescriptions <b>ACCESSIBILITY FOR PERSONS WITH DISABILITIES AND PERSONS WITH REDUCED MOBILITY</b>			UTP PRM Page 75 of 89
	Status: <b>PROPOSAL</b>	Version: 05	Ref.: A 94-05/1.2014	Original: EN

UTP NOI<sup>25</sup>;

2006/66/EC Noise TSI);

the array consists of 8 microphones evenly spaced around a circle of radius 250mm.

Testing to be carried out with the array arranged horizontally (all microphones the same distance above the floor, as shown in Figure G1). The average of the readings from all 8 microphones will be used for the assessment.

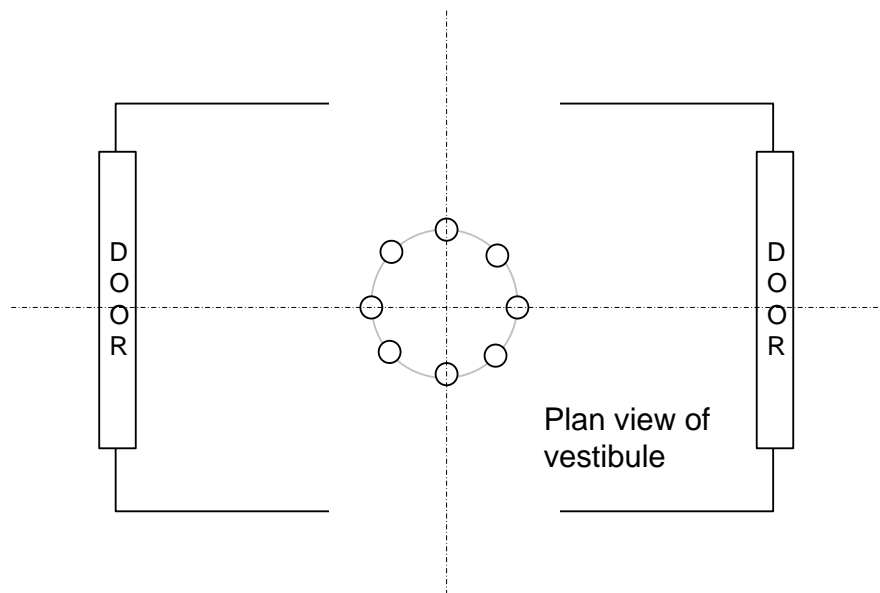

Figure G1 Horizontal array set-up

#### External measurement method for Passenger door audible warnings (Open and Close)

Tests to be carried out using an averaged reading from a multiple microphone array (designed for measuring horn noise in the cab in accordance with

UTP NOI;

2006/66/EC Noise TSI);

the array consists of 8 microphones evenly spaced around a circle of radius 250 mm.

For the external test the assumed platform height should be specific to the route on which the vehicle is designed to be operated (if the operated route covers more than 1 height of platform then the lower height should be used i.e. 760 and 550 mm high platforms are on the operated route then the test will be carried out for the lower which would be 550mm).

Testing to be carried out with the array arranged horizontally (all microphones the same distance above the platform) The average of the readings from all 8 microphones will be used for the assessment

In case an adaptive audible warning device is used, the device shall define the surrounding noise level prior to the warning sequence. A frequency band from 500 Hz up to 5000Hz shall be taken in consideration.

<sup>25</sup> ROLLING STOCK – NOISE, General Provisions, UTP NOI, APTU (A 94-04/2.2012)

 <b>OTIF</b>	Uniform Technical Prescriptions <b>ACCESSIBILITY FOR PERSONS WITH DISABILITIES AND  PERSONS WITH REDUCED MOBILITY</b>			UTP PRM Page 76 of 89
Status: <b>PROPOSAL</b>	Version: 05	Ref.: A 94-05/1.2014	Original: EN	Date: 28.03.2014

Measurements to demonstrate compliance shall be carried out at three door locations on a train.

Note: the door should be fully open for the close test and fully closed for the open test.

 <b>OTIF</b>	Uniform Technical Prescriptions <b>ACCESSIBILITY FOR PERSONS WITH DISABILITIES AND          PERSONS WITH REDUCED MOBILITY</b>		UTP PRM Page 77 of 89
	Status: <b>PROPOSAL</b>	Version: 05	Ref.: A 94-05/1.2014

## APPENDIX H: DIAGRAMS OF PRIORITY SEATS

Key for figures H1 to H4

- 1 Measuring level for seating surfaces
- 2 Distance between facing seats
- 3 Headroom above seat

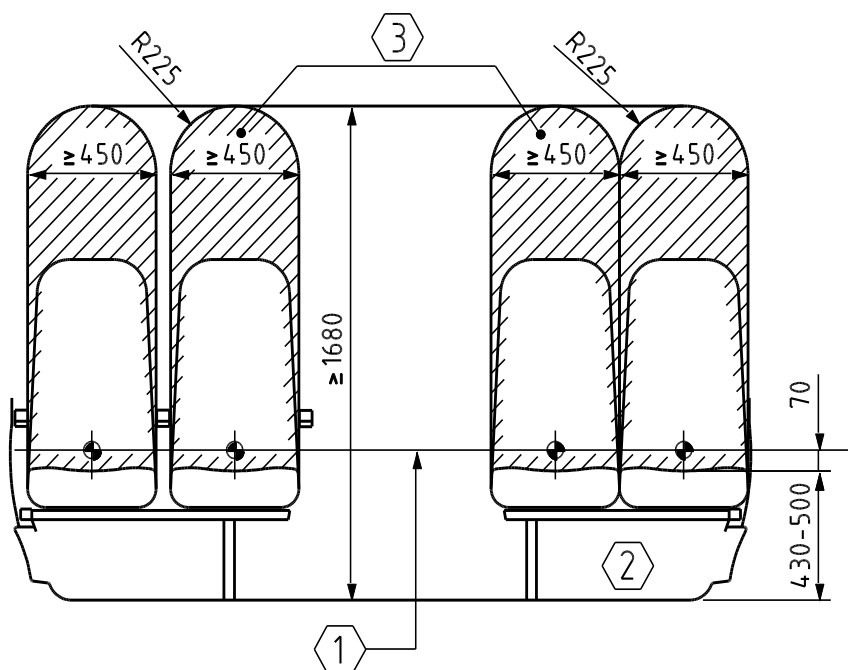

Figure H1 - Priority seat headroom

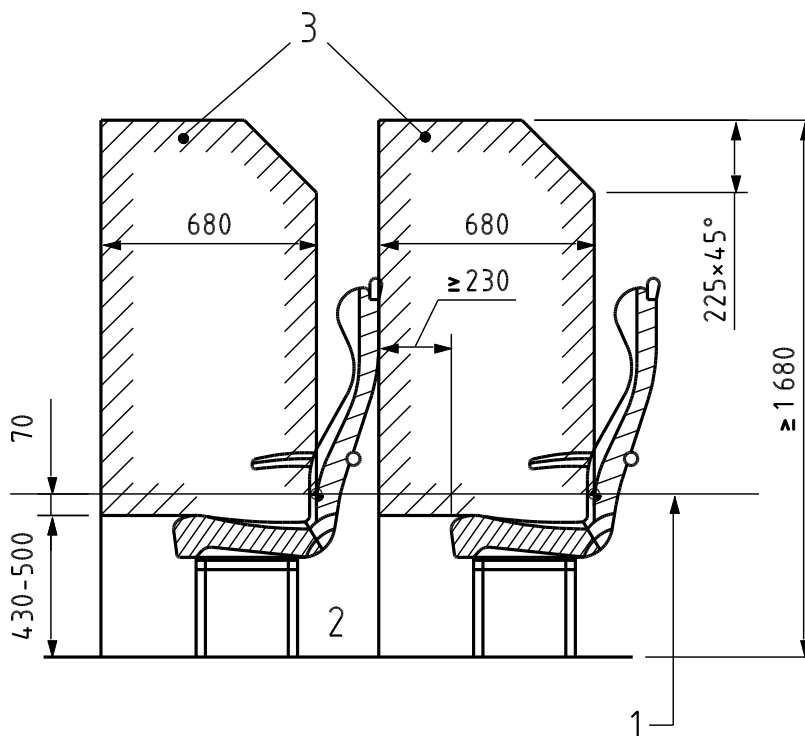

Figure H2 - Unidirectional priority seats

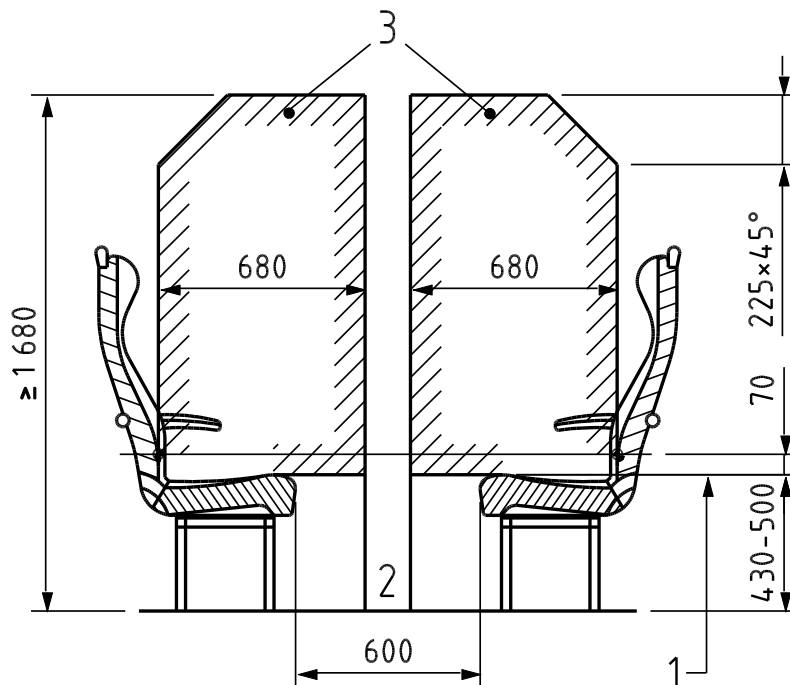

Figure H3 - Facing priority seats

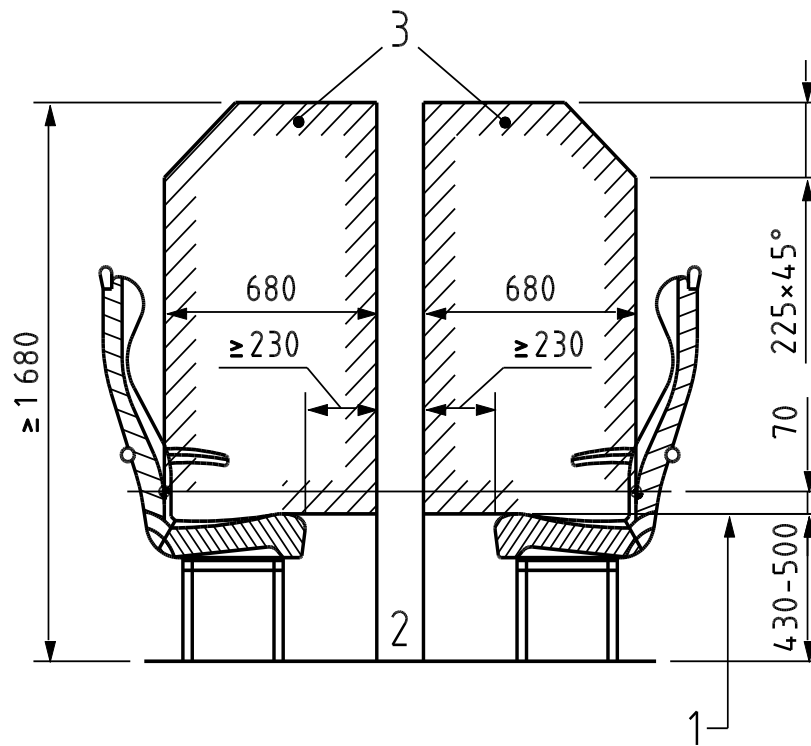



Figure H4 - Facing priority seats with table in stored position

 <b>OTIF</b>	Uniform Technical Prescriptions <b>ACCESSIBILITY FOR PERSONS WITH DISABILITIES AND          PERSONS WITH REDUCED MOBILITY</b>			UTP PRM Page 80 of 89
	Status: <b>PROPOSAL</b>	Version: 05	Ref.: A 94-05/1.2014	Original: EN

## APPENDIX I: DIAGRAMS OF WHEELCHAIR SPACES

- 1 Structure at end of wheelchair space
- 2 Front edge of passenger seat cushion
- 3 Wheelchair space

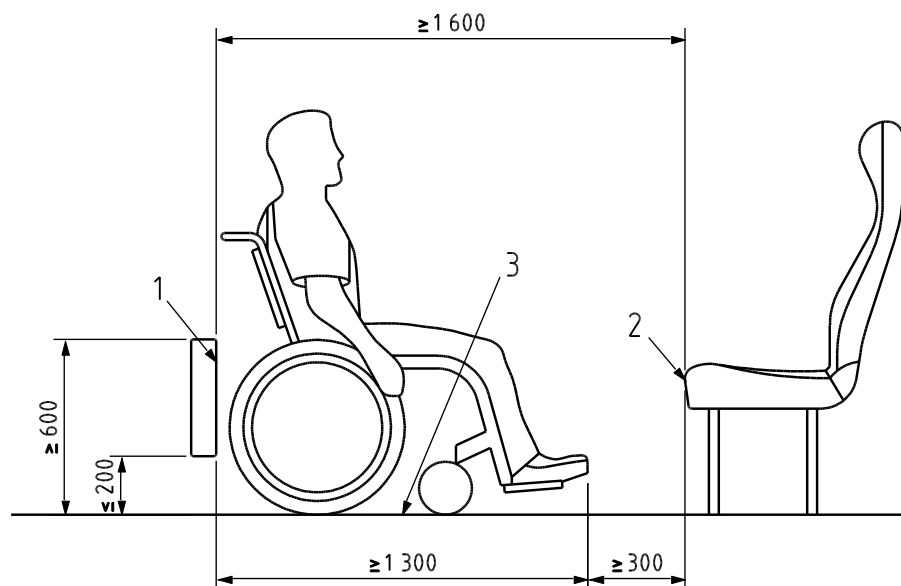

Figure I1 - Wheelchair space in facing seating arrangement

- 1 Structure at end of wheelchair space
- 2 Back of the front passenger seat
- 3 Wheelchair space





Status: <b>PROPOSAL</b>	Version: 05	Ref.: A 94-05/1.2014	Original: EN	Date: 28.03.2014
-------------------------	-------------	----------------------	--------------	------------------

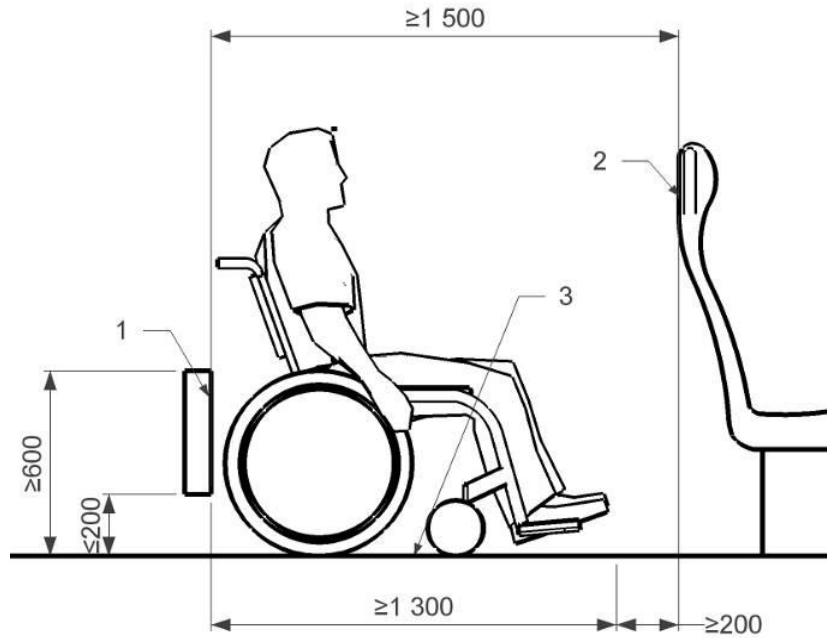

Figure I2 - Wheelchair space in unidirectional seating arrangement

- 1 Structure at end of wheelchair space
- 2 Space between wheelchair spaces min. 250 mm
- 3 Wheelchair space

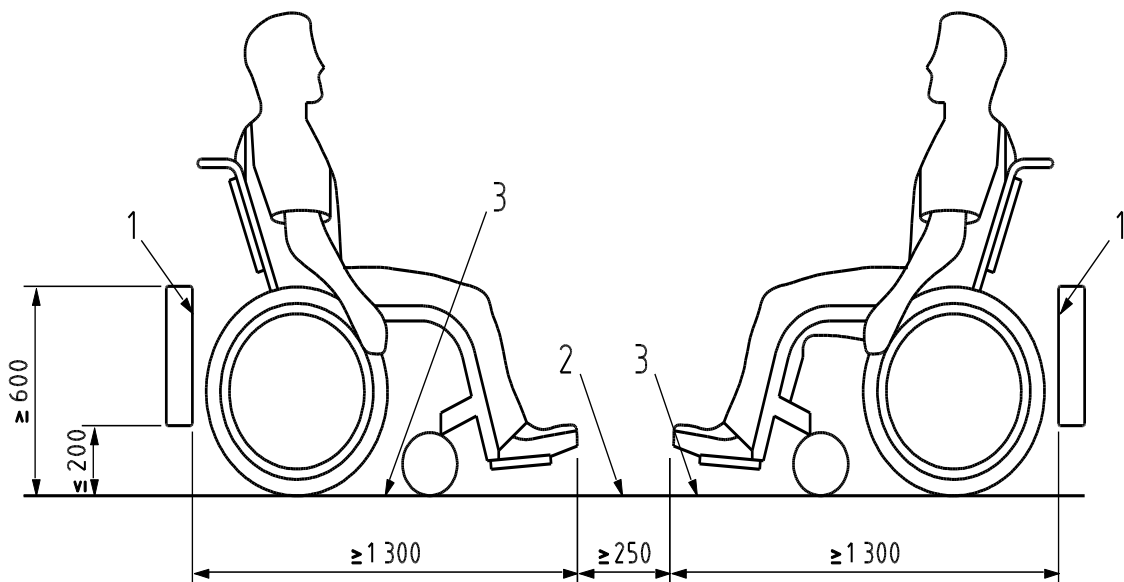



Figure I3 - Two facing wheelchair spaces

- 1 Structure at end of wheelchair space

 <b>OTIF</b>	Uniform Technical Prescriptions <b>ACCESSIBILITY FOR PERSONS WITH DISABILITIES AND PERSONS WITH REDUCED MOBILITY</b>			UTP PRM Page 82 of 89
Status: <b>PROPOSAL</b>	Version: 05	Ref.: A 94-05/1.2014	Original: EN	Date: 28.03.2014

- 2 Structure in front of wheelchair space
- 3 Dual wheelchair space

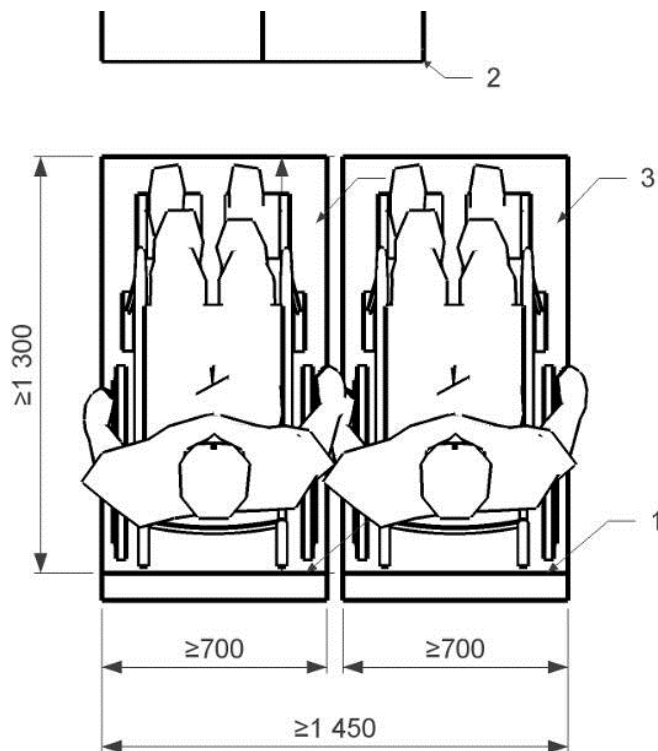



Figure I4 - Two adjacent wheelchair spaces (applicable to upgraded/renewed rolling stock only)

 <b>OTIF</b>	Uniform Technical Prescriptions <b>ACCESSIBILITY FOR PERSONS WITH DISABILITIES AND          PERSONS WITH REDUCED MOBILITY</b>			UTP PRM Page 83 of 89
	Status: <b>PROPOSAL</b>	Version: 05	Ref.: A 94-05/1.2014	Original: EN

**APPENDIX J: DIAGRAMS OF CLEARWAYS**

- 1 Through section of clearway
- 2 Plan view at height range 25 – 975 mm from floor level

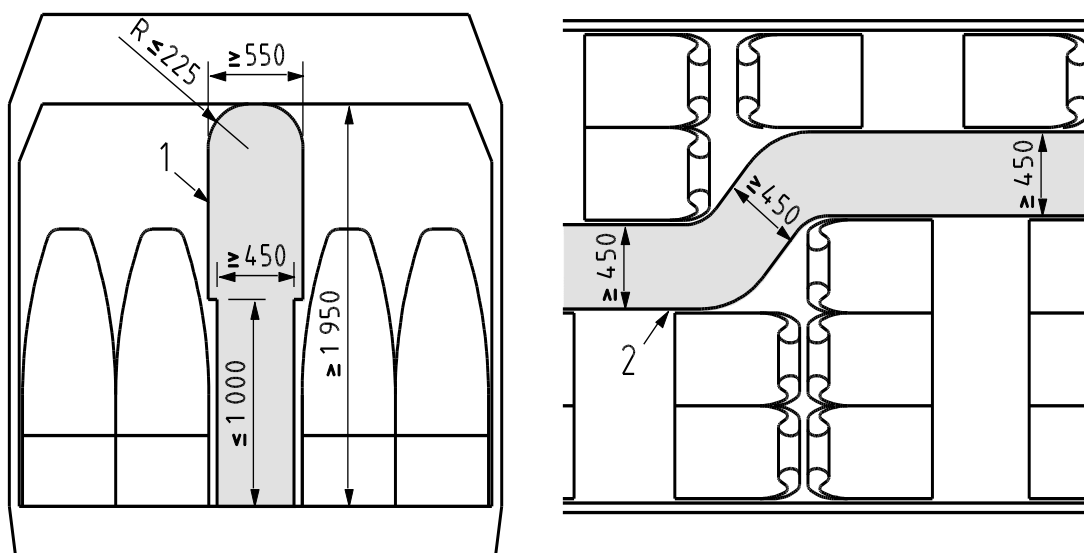
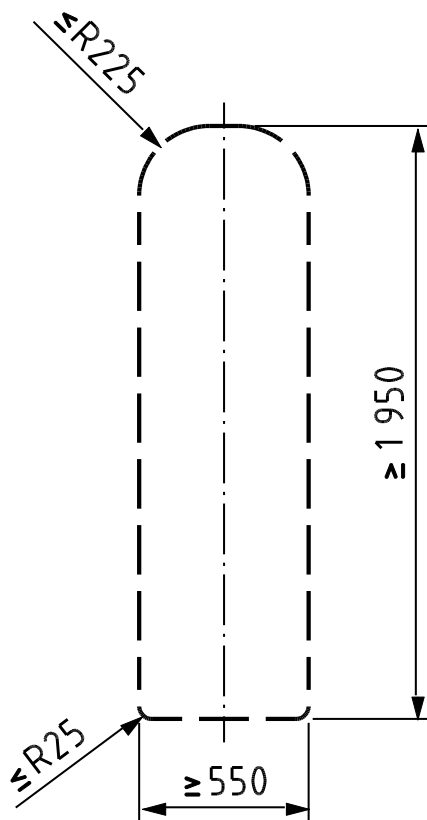

Figure J1 - Minimum clearway width from floor level to a height of 1000mm



 <b>OTIF</b>	Uniform Technical Prescriptions <b>ACCESSIBILITY FOR PERSONS WITH DISABILITIES AND          PERSONS WITH REDUCED MOBILITY</b>			UTP PRM Page 84 of 89
	Status: <b>PROPOSAL</b>	Version: 05	Ref.: A 94-05/1.2014	Original: EN

Figure J2 - Minimum clearway profile between connecting vehicles of a single trainset

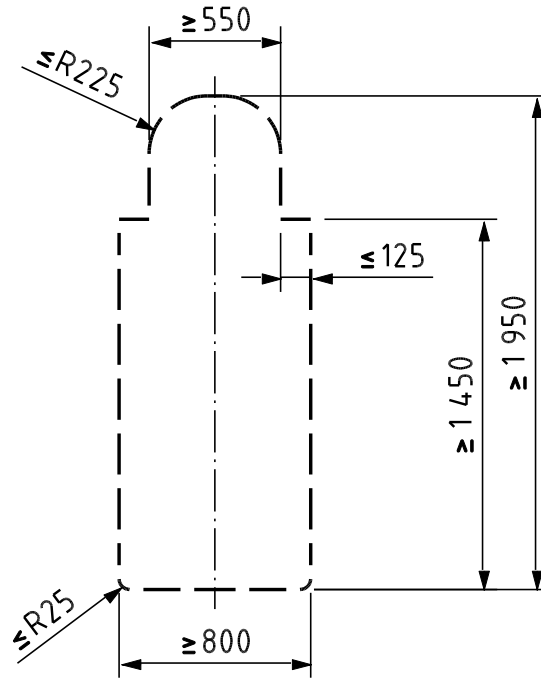



Figure J3 - Minimum clearway profile to and from wheelchair spaces

 <b>OTIF</b>	Uniform Technical Prescriptions <b>ACCESSIBILITY FOR PERSONS WITH DISABILITIES AND          PERSONS WITH REDUCED MOBILITY</b>			UTP PRM Page 85 of 89
	Status: <b>PROPOSAL</b>	Version: 05	Ref.: A 94-05/1.2014	Original: EN

**APPENDIX K: TABLE OF THE CORRIDOR WIDTH FOR WHEELCHAIR ACCESSIBLE AREAS IN ROLLING STOCK**

Corridor clearway width (mm)	1200	1100	1000	900	850	800
Door usable width, or a perpendicular corridor clearway width (mm)	800	850	900	1000	1100	1200

Table K1

 <b>OTIF</b>	Uniform Technical Prescriptions <b>ACCESSIBILITY FOR PERSONS WITH DISABILITIES AND          PERSONS WITH REDUCED MOBILITY</b>			UTP PRM Page 86 of 89
	Status: <b>PROPOSAL</b>	Version: 05	Ref.: A 94-05/1.2014	Original: EN

## APPENDIX L: REACH ZONE OF A WHEELCHAIR USER

1 – comfortable reach range

2 – seat reference point

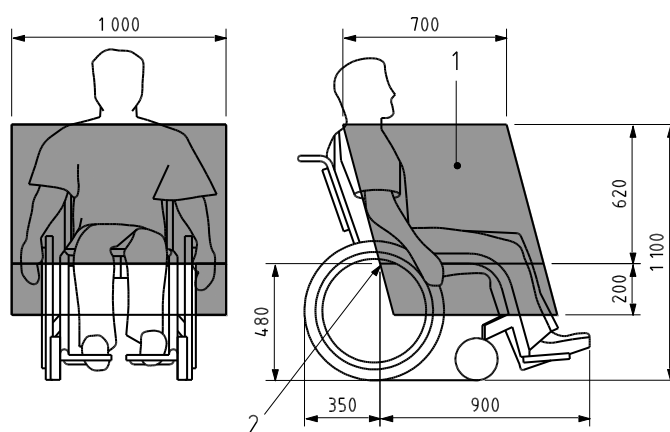



Figure L1 - Reach range of a person in a wheelchair

 <b>OTIF</b>	Uniform Technical Prescriptions <b>ACCESSIBILITY FOR PERSONS WITH DISABILITIES AND PERSONS WITH REDUCED MOBILITY</b>			UTP PRM Page 87 of 89
	Status: <b>PROPOSAL</b>	Version: 05	Ref.: A 94-05/1.2014	Original: EN

## **APPENDIX M: WHEELCHAIR TRANSPORTABLE BY TRAIN**

### **M.1 SCOPE**

This appendix identifies the maximum engineering limits for a wheelchair transportable by train.

### **M.2 CHARACTERISTICS**

The minimum technical requirements are:

#### **Basic Dimensions**

Width of 700mm plus 50mm min each side for hands when moving

Length of 1200mm plus 50mm for feet

#### **Wheels**

The smallest wheel shall accommodate a gap of dimensions 75mm horizontal and 50mm vertical

#### **Height**

1375mm max including a 95<sup>th</sup> percentile male occupant

#### **Turning circle**

1500mm

#### **Weight**

Fully laden weight of 300kg for wheelchair and occupant (including any baggage) in the case of an electrical wheelchair for which no assistance is required for crossing a boarding aid.

Fully laden weight of 200kg for wheelchair and occupant (including any baggage) in the case of a manual wheelchair.

#### **Obstacle height that can be overcome and ground clearance**

Obstacle height that can be overcome 50mm (max)

Ground clearance 60mm (min) with a upward slope angle of 10° on top for going forward (under the foot rest)

#### **Maximum safe slope on which the wheelchair will remain stable:**

Shall have dynamic stability in all directions at an angle of 6 degrees

Shall have static stability in all directions (including with brake applied) at an angle of 9 degrees.

 <b>OTIF</b>	Uniform Technical Prescriptions <b>ACCESSIBILITY FOR PERSONS WITH DISABILITIES AND PERSONS WITH REDUCED MOBILITY</b>			UTP PRM Page 88 of 89
	Status: <b>PROPOSAL</b>	Version: 05	Ref.: A 94-05/1.2014	Original: EN

## APPENDIX N: PRM SIGNAGE

### N.1 SCOPE

This appendix identifies specific signage for use on both infrastructure and rolling stock.

### N.2 DIMENSIONS OF SIGNS

Infrastructure PRM signage dimensions shall be calculated according to the formula:

Reading distance in mm divided by 250, multiplied by 1.25 = frame size in mm, where a frame is utilised.

The minimum tile size of rolling stock interior PRM signs shall be 60 mm with the exception of signs indicating utilities in the toilets or in the nursery that can be smaller.

The minimum tile size of rolling stock exterior PRM signs shall be 85mm.

### N.3 Symbols to use on signs

The signs provided for in point 4.2.1.10 shall have a dark blue background and a white symbol. Dark blue shall have a contrast of 0.6 relatively to white.

Where those signs are placed on a dark blue panel, it is allowed to invert the colours of the symbol and the background (i.e. dark blue symbol on a white background).

#### International wheelchair sign

The sign which identifies wheelchair accessible areas shall include a symbol in accordance with the specifications referenced in Appendix A, index 12.

#### Inductive loop sign

The sign indicating where inductive loops are fitted shall include a symbol in accordance with the specification referenced in Appendix A, index 13.

#### Priority seating sign

The sign indicating where there are priority seats shall include symbols in accordance with figure N1.



 <b>OTIF</b>	Uniform Technical Prescriptions <b>ACCESSIBILITY FOR PERSONS WITH DISABILITIES AND PERSONS WITH REDUCED MOBILITY</b>			UTP PRM Page 89 of 89
Status: <b>PROPOSAL</b>	Version: 05	Ref.: A 94-05/1.2014	Original: EN	Date: 28.03.2014



Figure N1 – Symbols for priority seats