



Organisation intergouvernementale pour les transports internationaux ferroviaires
Zwischenstaatliche Organisation für den internationalen Eisenbahnverkehr
Intergovernmental Organisation for International Carriage by Rail

Commission d'experts techniques
Fachausschuss für technische Fragen
Committee of Technical Experts

TECH-20041

20.10.2020

Original: EN

13TH SESSION (2021)

[Draft] proposal for the adoption of modifications to the Uniform Technical Prescription applicable to the subsystem “Rolling stock – locomotives and passenger rolling stock”

(UTP LOC&PAS)

1. INTRODUCTION

In accordance with Article 20 § 1 b) of COTIF and Article 6 of APTU (Appendix F to COTIF), the Committee of Technical Experts is competent to take decisions about the adoption of a Uniform Technical Prescription (UTP) or a provision amending a UTP.

This proposal concerns the modification of the UTP applicable to the subsystem “rolling stock – locomotives and passenger rolling stock” (UTP LOC&PAS) in the version of 1 December 2016.

The proposal has been developed on the basis of COTIF as last amended on 1 March 2019, in particular Article 8 of the APTU Uniform Rules (Appendix F to COTIF).

2. CONTEXT AND SUBSTANCE OF THE PROPOSAL

The aim of this proposal to modify the UTP LOC&PAS is to incorporate the new elements brought about by the revision of the APTU Uniform Rules of 1 March 2019 and to keep it aligned with legal developments in the European Union.

The proposed modifications include:

- Clarification of the technical scope.
- Editorial modifications, including limiting the use of the two-column layout to substantial differences between the OTIF rules and the EU rules to make the text easier to read.
- New requirements concerning automatic variable gauge systems, intended to close the open point on this function.
- New requirements concerning eddy current track brakes, intended to close the open point on this function.
- New requirements on aerodynamic effects, including slipstream effects on passengers on platforms and on trackside workers and head pressure pulse.
- New requirements concerning the on-board energy measuring system.
- New optional requirements for units to be used in general operation.
- Update of the procedure in relation to the competences of the Committee of Technical Experts and the Secretary General concerning the use of ‘innovative solutions’.
- New rules applicable when existing units or existing unit types are modified, including rules on whether or not the changes require a new admission to international traffic.
- New rules applicable when the area of use of existing rolling stock is being extended.
- Update of the list of specific cases, by adding the specific cases applicable to the Great Britain network of the United Kingdom of Great Britain and Northern Ireland, in so far as these specific cases are relevant to international traffic.
- Update of references to standards and other legal texts, including new European Union legislation.
- Deletion of Appendices of which the substance has become available in a standard.

The proposed modifications are set out in the Annex in the form of track changes.

3. PREPARATORY WORK

The proposal has been prepared by the OTIF Secretariat in coordination with WG TECH. The first draft version was prepared for review by WG TECH at its 40th session (remote meeting, 17-18 June 2020). Revised drafts were subsequently reviewed at the 41st session of WG TECH (remote meeting, 9-10 September 2020) and at the 42nd session of WG TECH (remote meeting, 17-18 November 2020).

4. JUSTIFICATION

Since the current version of the UTP LOC&PAS entered into force on 1 January 2015, the APTU Uniform Rules have been revised and entered into force on 1 March 2019. The following requirement was added to Article 8 § 4 to specify that UTPs should:

...indicate the provisions applicable to the existing subsystems and vehicles, in particular in the event of upgrading and renewal and, in such cases, the modification work which requires an application for a new admission [...]

The aim of the proposal is to indicate such provisions in the UTP LOC&PAS.

Furthermore, in order to ensure the continued mutual recognition of vehicles authorised in accordance with European Union law and vehicles admitted to international operation in accordance with Article 3a of ATMF, the European Union TSIs and COTIF UTPs must remain aligned.

The current UTP LOC&PAS was developed on the basis of the European Union LOC&PAS TSI of 2014¹. This EU TSI has been amended several times since then, including on 16 May 2019 by Commission Implementing Regulation (EU) 2019/776 and on 9 March 2020 by Commission Implementing Regulation (EU) 2020/387.

The proposed modifications will align the UTP LOC&PAS with the latest version of the APTU Uniform Rules and will ensure continued full equivalence in the meaning of ATMF with the European Union LOC&PAS TSI.

In addition, following Brexit, the specific cases for the Great Britain network of the United Kingdom of Great Britain and Northern Ireland should be listed in the UTP.

[DRAFT] PROPOSAL FOR DECISION

1. In accordance with Article 20 § 1 b) and Article 35 of COTIF and Article 6 of the APTU Uniform Rules, the Committee of Technical Experts adopts the Uniform Technical Prescription for subsystem rolling stock – locomotives and passenger rolling stock, as set out in the Annex (reference TECH-20041 Annex).
2. The Annex shall replace the UTP LOC&PAS of 1 January 2015; the previous version shall therefore be repealed at the moment of entry into force of the new version.
3. The Committee of Technical Experts instructs the Secretary General to publish the new version on the Organisation's website, although the repealed version should also remain available on the Organisation's website for future reference.

¹ Commission Regulation No 1302/2014 of 18 November 2014 concerning a technical specification for interoperability relating to the 'rolling stock — locomotives and passenger rolling stock' subsystem of the rail system in the European Union



Organisation intergouvernementale pour les transports internationaux ferroviaires

Zwischenstaatliche Organisation für den internationalen Eisenbahnverkehr

Intergovernmental Organisation for International Carriage by Rail

Uniform Technical Prescription

Subsystem: Rolling stock

LOCOMOTIVES AND
PASSENGER ROLLING
STOCK

UTP LOC&PAS ~~2015~~

Applicable from [Click here to enter a date.](#)

 OTIF	Uniform Technical Prescription (UTP)		UTP LOC&PAS	
	LOCOMOTIVES AND PASSENGER ROLLING STOCK		Page 2 of 272	
Status: DRAFT	Version: 03	TECH-20041 Annex	Original: EN	Date: 20.10.2020

Amendments record

Reference	Date	Description and comments
Version 1 TECH-20023	19.05.2020	<p>First draft for review by WG TECH 40.</p> <p>Changes are indicated in track changes compared to the version of UTP LOC&PAS which entered into force on 1 January 2015.</p> <p>The following EU documents have been used as input:</p> <ol style="list-style-type: none"> 1. Regulation (EU) 2016/919 of 27 May 2016 (CCS TSI) 2. Regulation (EU) 2018/868 of 13 June 2018 (on Energy Measuring system and data collecting system) 3. Regulation (EU) 2019/776 of 16 May 2019 (Amendments to TSIs) 4. Regulation (EU) 2020/387 of 9 March 2020 (Extension of the Area of Use) <p>Main amendments:</p> <ol style="list-style-type: none"> (1) Alignment with Commission Implementing Regulation (EU) 2019/776 of 16 May 2019 (4th Railway Package). Alignment with energy measuring system and data collection system requirements (2) Modifications to better reflect responsibilities of the Secretary General, the CTE and Member States. (3) Deletion of Appendix K as parameters are to be covered in a new UTP on train composition and route compatibility checks (UTP TCRC)
Version 2 TECH-20023	12.08.2020	<p>Version for review by WG TECH 41.</p> <p>Modifications compared to version 1 are in track changes and marked yellow</p>
Version 3 TECH-20041 Annex	20.10.2020	<p>Version for review by WG TECH 42.</p> <p>Reference renamed to TECH-20041 Annex.</p> <p>Modifications compared to version 2 are in track changes and marked yellow.</p> <p>Appendix K is no longer deleted, as it should be deleted only once the UTP TCRC enters into force. The decision to delete Appendix K should therefore be taken with the adoption of the UTP TCRC.</p>

 OTIF	Uniform Technical Prescription (UTP)		UTP LOC&PAS	
	LOCOMOTIVES AND PASSENGER ROLLING STOCK		Page 3 of 272	
Status: DRAFT	Version: 03	TECH-20041 Annex	Original: EN	Date: 20.10.2020

APTU Uniform Rules (Appendix F to COTIF 1999)

Uniform Technical Prescriptions (~~UTP~~)

applicable to the ~~Rolling Stock~~ subsystem:

÷ “rolling stock -LOCOMOTIVES AND PASSENGER ROLLING STOCK”

(UTP LOC&PAS)

This UTP has been developed in accordance with COTIF in the version of 1 March 2019 and in particular with Articles 3, 4, 6, 7, 7a and 8 of the APTU Uniform Rules (Appendix F to COTIF).

For definitions, see also Article 2 of the APTU Uniform Rules and Article 2 of the ATMF Uniform Rules (Appendix G to COTIF).

~~These regulations have been developed in accordance with the provisions of APTU, in particular Article 8, in the version as amended by the OTIF Revision Committee in 2009, which entered into force on 1 December 2010. For definitions and terms, see also Article 2 of APTU (Appendix F) and Article 2 of ATMF (Appendix G), both Appendices to the 1999 version of the COTIF Convention as applicable since 1 December 2010. Footnotes (which are not part of the regulations legal provisions), they include both explanatory information and references to other regulations.~~

~~Explanatory note:~~

~~The texts of this UTP which appear across two columns are identical to corresponding texts of the European Union regulations. Texts which appear in two columns differ; the left hand column contains the UTP regulations, the right hand column shows the text in the corresponding EU regulations. The text in the right hand column is for information only and is not part of the OTIF regulations. Texts in the right hand column which are not quoted from the LOC&PAS TSI, but from other EU regulations, are in italics.~~

0. PURPOSE AND EQUIVALENCE ~~AND TRANSITIONAL PROVISIONS~~

Following their adoption by the Committee of Technical Experts, the OTIF ~~regulations~~ provisions included in this document are declared equivalent to the corresponding EU regulations within the

 OTIF	Uniform Technical Prescription (UTP)		UTP LOC&PAS
	LOCOMOTIVES AND PASSENGER ROLLING STOCK		Page 4 of 272
Status: DRAFT	Version: 03	TECH-20041 Annex	Original: EN Date: 20.10.2020

meaning of Article 13_§.4 of APTU¹ and Article 3a of ATMF², in particular with:

- [Commission Regulation \(EU\) No 1302/2014 of 18 November 2014 concerning a technical specification for interoperability relating to the ‘rolling stock — locomotives and passenger rolling stock’ subsystem of the rail system in the European Union](#) ~~The TSI for Locomotives and Passenger Rolling Stock Commission Regulation as last amended by Commission Implementing Regulation (EU) 2020/387 of 9 March 2020 amending Regulations (EU) No 321/2013, (EU) No 1302/2014 and (EU) 2016/919 as regards the extension of the area of use and transition phase~~ ~~Commission Implementing Regulation (EU) 2019/776 of 16 May 2019~~, hereinafter referred to as ~~LOC&PAS TSI: 2014~~.

• ~~Commission Implementing Regulation (EU) 2018/868 of 13 June 2018 amending Regulation (EU) No 1301/2014 and Regulation (EU) No 1302/2014 as regards provisions on energy measuring system and data collecting system.~~

~~In addition, this UTP contains the following Appendix:~~

~~Appendix K, setting out the provisions for the safe operation of rolling stock. Equivalent provisions in the EU are part of the OPE TSI (Commission Decision 2012/757/EU of 14 November 2012).~~

[Transitional provisions for the application of this UTP](#) are laid down in chapter 7.

~~This UTP enters into force on 1.1.2015. Without prejudice to section 7, from the date of entry into~~

Reference to articles in the EU Decision enacting the LOC&PAS TSI:

Article 3

1. Without prejudice to Articles 8 and 9, and point 7.1.1 of the Annex, the TSI shall apply to all new

¹ **APTU** means the Uniform Rules concerning the Validation of Technical Standards and the Adoption of Uniform Technical Prescriptions applicable to Railway Material intended to be used in International Traffic – Appendix F to COTIF 1999 in the revised version that entered into force on 1 ~~December~~ March 2019⁰.

² **ATMF** means the Uniform Rules concerning Technical Admission of Railway Material used in International Traffic – Appendix G to COTIF 1999 in the revised version that entered into force on 1 ~~December~~ March 2019⁰.



~~force this UTP shall apply to all new rolling stock admitted to international traffic as defined in ATMF.~~

~~From the date of entry into force this UTP shall apply to rolling stock that is renewed or upgraded in accordance with the provisions in section 7.1.2.~~

This UTP contains open points as listed in Appendix I. With respect to these open points, Contracting States should notify their applicable National Technical Requirements in accordance with APTU Article 12 [§ 2](#).

~~Vehicles which are subject to either:~~

- ~~• open points as defined in this UTP, or~~
- ~~• specific cases as defined in this UTP or in the LOC&PAS TSI, which limit the conditions of admission, or~~
- ~~• are subject to a derogation in accordance with ATMF Annex B,~~

~~are subject to admission in accordance with ATMF Article 6 § 4.~~

~~For Elements of Construction (ICs) which are assessed separately from the subsystem in accordance with section 5.1 of this UTP: after a transitional period ending on 31 May 2017 all newly produced ICs shall be covered by the required declaration of conformity and/or suitability for use.~~

~~Until 31 May 2017, the provisions of section 6.3 of this UTP apply.~~

~~Rolling stock admitted to international operation after 31 May 2017 shall not include non-certified and separately assessed ICs.~~

~~rolling stock of the rail system in the Union, defined in Article 2(1), which is placed in service from 1.1.2015.~~

~~2. The TSI shall not apply to existing rolling stock of the rail system in the European Union which is already placed in service on all or part of the network of any Member State on 1 January 1. 2015, except when it is subject to renewal or upgrading in accordance with Article 20 of Directive 2008/57/EC and Section 7.1.2 of the Annex.~~

~~Article 4~~

~~1. With regard to the aspects classified listed as 'open points' set out in Appendix I of the Annex to this Regulation, the conditions to be complied with for verifying the essential requirements set out in Annex III to interoperability pursuant to Article 17(2) of Directive (EU) 2016/08/79757/EC shall be those laid down by national rules applicable in force in the Member States which are part of the area of use of the vehicles authorises the placing in service of the subsystem covered by this Regulation.~~

~~Article 8~~

~~1. An 'EC' certificate of verification for a subsystem that contains interoperability constituents which do not have an 'EC' declaration of conformity or suitability for use may be issued during a transitional period ending on 31 May 2017 provided the provisions laid down in Section 6.3 of the Annex are met.~~

~~2. The production or upgrade/renewal of the subsystem using non-certified interoperability constituents shall be completed within the~~



~~Transitional periods prescribed in points: 4.2.3.1, 6.3.1, 7.1.1. are valid as follows...~~

~~transitional period set out in paragraph 1, including the placing in service.~~

The objectives and scope of COTIF and the EU law concerning railways are not identical and it has therefore been necessary to use different terminology for concepts that have a similar but not identical meaning. The following table lists the terms used in this UTP and the corresponding terms used in the relevant TSI:

<u>This UTP</u>	<u>EU law</u>
<u>Uniform Technical Prescriptions (UTP)</u>	<u>Technical Specification of Interoperability (TSI)</u>
<u>UTP PRM</u>	<u>PRM TSI</u>
<u>UTP NOI</u>	<u>NOI TSI</u>
<u>UTP GEN-G</u>	<u>CSM on RA</u>
<u>UTP LOC&PAS</u>	<u>LOC&PAS TSI</u>
<u>UTP INF</u>	<u>INF TSI</u>
<u>UTP GEN-G</u>	<u>CSM on RA</u>
<u>Competent Authority</u>	<u>National Safety Authority or authorising entity</u>
<u>UTP verification procedure</u>	<u>EC verification procedure</u>
<u>Assessing entity</u>	<u>Notified body</u>
<u>Type or design examination certificate</u>	<u>EC type or design examination certificate</u>
<u>UTP declaration for verification</u>	<u>EC declaration for verification</u>
<u>Assessment procedures for the verification of subsystems (modules)</u>	<u>EC verification of a subsystem (modules)</u>
<u>Assessment procedures for the</u>	<u>Modules for EC certification of</u>

 OTIF	Uniform Technical Prescription (UTP)		UTP LOC&PAS	
	LOCOMOTIVES AND PASSENGER ROLLING STOCK		Page 7 of 272	
Status: DRAFT	Version: 03	TECH-20041 Annex	Original: EN	Date: 20.10.2020

verification of elements of construction	conformity of interoperability constituents
UTP certificate of verification	Certificate of “EC” verification
Contracting State	Member State

[Where provisions in this UTP and the LOC&PAS TSI differ in substance, the respective texts are in a 2-column format. The left-hand column and the full width texts show the UTP provisions \(OTIF regulations\) and the right-hand column shows the European Union TSI texts. Texts in the right-hand column are strictly for information only. For EU law, consult the Official Journal of the European Union.](#)

[Where differences between texts of this UTP and the European Union LOC&PAS TSI are either editorial, or not substantive, or concern the list of terms quoted above, the LOC&PAS TSI texts are not generally reproduced. The TSI texts may however be reproduced to improve clarity and readability.](#)

1. INTRODUCTION

1.1 Technical scope

This

Uniform Technical Prescription (UTP)

~~technical specification for interoperability (TSI)~~

is a specification by which a particular subsystem is addressed in order to meet the essential requirements and ensure the interoperability

of the technical systems and components necessary in international rail ~~traffic transport~~ as described by Article 3_§_3 of APTU.

of the Union's rail system as described in Article 1 of Directive [\(EU\) 2016/797³](#) ~~2008/57/EC~~.

The particular subsystem is the rolling stock

³- [Directive \(EU\) 2016/797 of the European Parliament and of the Council of 11 May 2016 on the interoperability of the rail system within the European Union \(OJ L 138, 26.5.2016, p. 44\)](#). ~~Directive 2008/57/EC of the European Parliament and of the Council of 17 June 2008 on the interoperability of the rail system within the Community (OJ L 191, 18.07.2008, p.1.)~~

 OTIF	Uniform Technical Prescription (UTP)		UTP LOC&PAS	
	LOCOMOTIVES AND PASSENGER ROLLING STOCK		Page 8 of 272	
Status: DRAFT	Version: 03	TECH-20041 Annex	Original: EN	Date: 20.10.2020

referred to in section 2.7 of UTP GEN-B⁴

of the Union's rail system referred to in **Annex II** section 2.7 of [Annex II to Directive \(EU\) 2016/797/2008/57/EC](#).

This

UTP

TSI

is applicable to rolling stock:

- which is (or is intended to be) operated

in international traffic

on the rail network defined in the section 1.2 “Geographical scope” of this TSI

And

- which is of one of the following types

(as defined in section 2.7 of UTP GEN-B):

(as defined in **Annex I** sections ~~1.2 and 2.2~~ of [Annex I to Directive \(EU\) 2016/797/2008/57/EC](#)):

- Self-propelling thermal or electric trains;
- Thermal or electric traction units;
- Passenger carriages;
- Mobile railway infrastructure construction and maintenance equipment.

Rolling stock of the types mentioned in Article 1(3) **and (4)** of Directive [\(EU\) 2016/797/2008/57/EC](#) are excluded from the scope of this TSI:

Metros, tram, and other light rail vehicles;

Vehicles for the operation of local, urban or suburban passenger services on networks that are functionally separate from the rest of the railway system;

Vehicles exclusively used on privately owned railway infrastructure that exist solely for use by the owner for its own freight operations;

Vehicles reserved for a strictly local, historical or touristic use.

The detailed definition of the rolling stock in the scope of this

UTP

TSI

⁴ [Subsystems– General Provisions, UTP GEN-B 2017 as last amended on 1 June 2019, APTU \(A 94 01B/1.2012\)](#)

 OTIF	Uniform Technical Prescription (UTP)		UTP LOC&PAS	
	LOCOMOTIVES AND PASSENGER ROLLING STOCK		Page 9 of 272	
Status: DRAFT	Version: 03	TECH-20041 Annex	Original: EN	Date: 20.10.2020

is given in Chapter 2.

On the basis of Article 6 of ATMF, for the part of the vehicle which is compliant with this UTP or part of it, competent authorities of Contracting States have to accept verifications that have been made by other competent authorities or assessing entities according to this UTP.

Additional verifications of the rolling stock subsystem of vehicles that fully comply with this UTP by competent authorities of Contracting States shall be limited to:

- Specific cases identified in chapter 7 which affect technical compatibility with the network of the Contracting State concerned,
- Technical compatibility with the network of the Contracting State concerned,
- Provisions related to the open point identified in this UTP and the National Technical Requirements notified in accordance with Article 12 of APTU.

1.2 Geographical scope

The geographical scope of this

UTP comprises all lines open to, or used for international traffic, ~~taking into account the limitation as set out in Section 1.1.~~

TSI is the Union rail system as set out in Annex I to Directive (EU) 2016/797 and excludes the cases referred to in Articles 1 (3) and (4) of Directive (EU) 2016/797, ~~network of the whole rail system, composed of:~~

~~The trans-European conventional rail system network (TEN) as described in Annex I section 1.1 “Network” of Directive 2008/57/EC~~

~~The trans-European high-speed rail system network (TEN) as described in Annex I section 2.1 “Network” of Directive 2008/57/EC~~

~~Other parts of the network of the whole rail system, following the extension of the scope as described in Annex I section 4 of Directive 2008/57/EC,~~

~~and excludes the cases referred to in Article 1(3) of Directive 2008/57/EC.~~

 OTIF	Uniform Technical Prescription (UTP)		UTP LOC&PAS	
	LOCOMOTIVES AND PASSENGER ROLLING STOCK		Page 10 of 272	
Status: DRAFT	Version: 03	TECH-20041 Annex	Original: EN	Date: 20.10.2020

1.3 Content of this UTP

In accordance with Article 8.§.4 of APTU this UTP: In accordance with Article ~~54~~(3) of Directive [\(EU\) 2016/797](#) ~~2008/57/EC~~ this TSI:

- indicates its intended scope (Chapter 2);
- lays down essential requirements for the subsystem rolling stock “Locomotives and passenger rolling stock”⁵ and its interfaces vis-à-vis other subsystems (Chapter 3);
- establishes the functional and technical specifications to be met by the subsystem and its interfaces vis-à-vis other subsystems (Chapter 4);

- determines the

elements of construction (also referred to in this document as interoperability constituents or ICs)	interoperability constituents
and interfaces which must be covered by	
technical standards	European specifications, including European standards,
which are necessary to achieve interoperability within the	
rail system (Chapter 5);	European Union's

- states, in each case under consideration, which procedures are to be used in order to assess the conformity

with the provisions of the UTP. These procedures are based on the assessment modules defined in UTP GEN-D ⁵	or the suitability for use of the interoperability constituents, on the one hand, or the “EC” verification of the subsystems, on the other hand
--	---

 (Chapter 6);

- indicates the strategy for implementing this UTP (Chapter 7);

~~TSI~~

⁵ Assessment procedures (modules)– General Provisions, UTP-~~GEN-D~~-~~APTU (A 94 01D/3.2011)~~

 OTIF	Uniform Technical Prescription (UTP)		UTP LOC&PAS	
	LOCOMOTIVES AND PASSENGER ROLLING STOCK		Page 11 of 272	
Status: DRAFT	Version: 03	TECH-20041 Annex	Original: EN	Date: 20.10.2020

- indicates for the staff concerned, the professional qualifications and health and safety conditions at work required for the operation and maintenance of the subsystem, as well as for the implementation of this

UTP | **TSI**

(Chapter 4).

- indicates the provisions applicable to the existing “rolling stock” subsystem, in particular in the event of upgrading and renewal and, in such cases, the modification work which requires an application for a new

Admission to operation in international traffic (Chapter 7): | authorisation:

- indicates the parameters of “rolling stock” subsystem to be checked by the railway undertaking and the procedures to be applied to check those parameters

to ensure compatibility between vehicles and the routes on which they are operated. | after the delivery of the vehicle authorisation for placing on the market and before the first use of the vehicle to ensure compatibility between vehicles and the routes on which they are to be operated.

In accordance with

Article 8_§_46 of APTU,

Article ~~54~~(5) of Directive (EU) 2016/797~~2008/57/EC~~,

provisions ~~may be made for specific cases for each~~

~~UTP;~~

~~TSI;~~

~~such~~ for specific cases are indicated in Chapter 7.

2. ROLLING STOCK SUBSYSTEM AND FUNCTIONS

2.1 The rolling stock subsystem as part of the rail system

The rolling stock subsystem as part of the Union's rail system

The rail system

The Union's rail system

has been broken down into the following subsystems, as defined in

Chapter 1 of UTP GEN-B:

Annex II (section 1) of Directive (EU) 2016/797~~2008/57/EC~~:

 OTIF	Uniform Technical Prescription (UTP)		UTP LOC&PAS
	LOCOMOTIVES AND PASSENGER ROLLING STOCK		Page 12 of 272
Status: DRAFT	Version: 03	TECH-20041 Annex	Original: EN Date: 20.10.2020

(1) Structural areas:

- infrastructure;
- energy;
- trackside control-command and signalling;
- on-board control-command and signalling;
- rolling stock;

(2) Functional areas:

- operation and traffic management;
- maintenance;
- telematics applications for passenger and freight services.

With the exception of maintenance, each sub-system is dealt with in specific

UTP(s).

~~TSI(s).~~

The rolling stock subsystem dealt with in this

UTP

~~TSI~~

(as defined in Section 1.1) has interfaces with all other subsystems of the

Union

rail system mentioned above; these interfaces are considered within the frame of an integrated system, compliant with all the relevant

UTPs.

~~TSIs.~~

Additionally, there are two

TSIs describing

specific aspects of the railway system and concerning several subsystems, the rolling stock subsystem being one of them:

- safety in railway tunnels

The vehicle related requirements for the safe operation of trains in tunnels are included in this UTP. Specific requirements for the infrastructure and operations related to tunnels are presumed to be defined in each Contracting State in such a way that vehicles compliant with this UTP may be operated in tunnels.

(SRT TSI);

 OTIF	Uniform Technical Prescription (UTP)		UTP LOC&PAS
	LOCOMOTIVES AND PASSENGER ROLLING STOCK		Page 13 of 272
Status: DRAFT	Version: 03	TECH-20041 Annex	Original: EN Date: 20.10.2020

- accessibility for people with reduced mobility

(UTP PRM) | ~~(PRM TSI)~~

and two

UTPs | ~~TSIs~~

concerning particular aspects of the rolling stock subsystem:

- noise

(UTP NOI); | ~~(TSI Noise);~~

- freight wagons.

The requirements concerning the rolling stock subsystem expressed in

the UTP NOI, UTP WAG and the UTP PRM | these four TSIs

are not repeated in the present

UTP. | ~~TSI~~

The UTP NOI, UTP WAG and the UTP PRM | These four TSIs

apply also for the rolling stock subsystem according to their respective scopes and implementation rules.

2.2 Definitions related to rolling stock

For the purpose of this

UTP, | ~~TSI~~

the following definitions apply:

2.2.1 Train formation:

- (1) A **Unit** is the generic term used to name the rolling stock which is subject to the application of this

UTP | ~~TSI~~

and therefore subject to

OTIF technical admission. | “EC” verification.

- (2) A Unit may be composed of several **Vehicles** as defined in

 OTIF	Uniform Technical Prescription (UTP)		UTP LOC&PAS	
	LOCOMOTIVES AND PASSENGER ROLLING STOCK		Page 14 of 272	
Status: DRAFT	Version: 03	TECH-20041 Annex	Original: EN	Date: 20.10.2020

Article 2 w) of ATMF;

~~Directive 2008/57/EC, point (3) of Article 2 (e) of Directive (EU) 2016/797;~~

considering the scope of this

UTP,

~~TSI,~~

the use of the term “vehicle” in this

UTP

~~TSI~~

is limited to the rolling stock subsystem as defined in Chapter 1.

- (3) A **Train** is an operational formation consisting of one or more units.
- (4) A **Passenger train** is an operational formation accessible to passengers (a train composed of Passenger vehicles but not accessible to passengers is not considered as a Passenger train).
- (5) A “**Fixed formation**” is a train formation that can only be reconfigured within a workshop environment.
- (6) A “**Predefined formation(s)**” is a train formation(s) of several units coupled together, which is defined at design stage and can be reconfigured during operation.
- (7) “**Multiple operation**” is an operational formation consisting of more than one unit:
 - Trainsets designed so that several of them (of the type under assessment) are capable of being coupled together to operate as a single train controlled from 1 driver’s cab.
 - Locomotives designed so that several of them (of the type under assessment) are capable of being included in a single train controlled from 1 driver’s cab.
- (8) “**General operation**”: A unit is designed for general operation when the unit is intended to be coupled with other unit(s) in a train formation which is not defined at design stage.

2.2.2 Rolling stock:

Definitions below are classified in ~~four~~ three groups as ~~defined in the~~

~~section 2.7 of UTP GEN B; follows:~~

~~defined in the~~ section ~~1.2~~ of Annex I to Directive (EU) 2016/797 ~~2008/57/EC~~.

A) Locomotives and passenger rolling stock, including thermal or electric traction units, self-propelling thermal or electric passenger trains, and passenger coaches:

(1) ~~B)~~ Thermal ~~and~~/or electric traction units

A Locomotive is a traction vehicle (or combination of several vehicles) that is not intended to carry a payload and has the ability to be uncoupled in normal operation from a train and to operate independently.

A Shunter is a traction unit designed for use only on shunting yards, stations and depots.

Traction in a train can also be provided by a powered vehicle with or without driving cab, which is not intended to be uncoupled during normal operation. Such a vehicle is called a Power Unit (or power car) in general or a Power Head when located at one end of the trainset and fitted with a driving cab.

 OTIF	Uniform Technical Prescription (UTP)		UTP LOC&PAS	
	LOCOMOTIVES AND PASSENGER ROLLING STOCK		Page 15 of 272	
Status: DRAFT	Version: 03	TECH-20041 Annex	Original: EN	Date: 20.10.2020

(2) ~~A)~~ Self-propelling thermal and/or electric passenger trains can be

A Trainset is a fixed formation that can operate as a train; it is by definition not intended to be reconfigured, except within a workshop environment. It is composed of only motored or of motored and non-motored vehicles.

An Electric and/or Diesel Multiple Unit is a trainset in which all vehicles are capable of carrying a payload (passengers or luggage/mail or freight).

A Railcar is a vehicle that can operate autonomously and is capable of carrying a payload (passengers or luggage/mail or freight).

A tram – train is a vehicle designed for combined use on both a light-rail infrastructure and a heavy-rail infrastructure;

~~B) Thermal and/or electric traction units:~~

~~A Locomotive is a traction vehicle (or combination of several vehicles) that is not intended to carry a payload and has the ability to be uncoupled in normal operation from a train and to operate independently.~~

~~A Shunter is a traction unit designed for use only on shunting yards, stations and depots.~~

~~Traction in a train can also be provided by a powered vehicle with or without driving cab, which is not intended to be uncoupled during normal operation. Such a vehicle is called a Power Unit (or power car) in general or a Power Head when located at one end of the trainset and fitted with a driving cab.~~

(3) ~~C)~~ Passenger carriages coaches and other related cars

A Coach is a vehicle without traction in a fixed or variable formation capable of carrying passengers (by extension, requirements specified to apply to coaches in this

UTP

~~TSI~~

are deemed to apply also to restaurant cars, sleeping cars, couchettes cars, etc.).

A Van is a vehicle without traction capable of carrying payload other than passengers, e.g. luggage or mail, intended to be integrated into a fixed or variable formation which is intended to transport passengers.

A Driving Trailer is a vehicle without traction equipped with a driving cab.

A coach may be equipped with a driver's cab; such a coach is then named a Driving Coach.

A van may be fitted with a driver's cab and as such is known as a Driving Van.

A Car carrier is a vehicle without traction capable of carrying passenger motor cars without their passengers and which is intended to be integrated in a passenger train.

A Fixed Rake of Coaches is a formation of several coaches “semi-permanently” coupled together, or which can be reconfigured only when it is out of service.

B) Freight wagons, including low-deck vehicles designed for the entire network and vehicles designed to carry lorries

These vehicles are out of the scope of this UTP. They are covered by UTP WAG.

These vehicles are out of the scope of this TSI. They are covered by Regulation (EU) No 321/2013 (the “freight wagons” TSI)

 OTIF	Uniform Technical Prescription (UTP)		UTP LOC&PAS	
	LOCOMOTIVES AND PASSENGER ROLLING STOCK		Page 16 of 272	
Status: DRAFT	Version: 03	TECH-20041 Annex	Original: EN	Date: 20.10.2020

C) ~~D) Special vehicles, such as on-track machines~~ ~~Mobile railway infrastructure construction & maintenance equipment~~

On track Machines (OTMs) are vehicles specially designed for construction and maintenance of the track and infrastructure. OTMs are used in different modes: working mode, transport mode as self-propelling vehicle, transport mode as a hauled vehicle.

Infrastructure inspection vehicles are utilised to monitor the condition of the infrastructure. They are operated in the same way as freight or passenger trains, with no distinction between transport and working modes.

2.3 Rolling stock in the scope of this

UTP

TSI

2.3.1 Types of rolling stock

The scope of this

UTP is limited to rolling stock intended to be used in international traffic. The following paragraph defines further details and limitations within this general scope.

TSI

The scope of this UTP

~~concerning rolling stock, classified in four groups as defined in the section 2.7 of UTP GEN B,~~

concerning rolling stock, classified in three groups as defined in the Annex I section 1.2 of Directive (EU) 2016/797/2008/57/EC,

is detailed as follows:

A) Locomotives and passenger rolling stock, including thermal or electric traction units, self-propelling thermal or electric passenger trains, and passenger coaches:

(1) ~~B) Thermal and/or electric traction units~~

This type includes traction vehicles that are not capable of carrying a payload, such as thermal or electric locomotives or power units.

The concerned traction vehicles are intended for freight or/and passenger transport.

Exclusion from the scope:

Shunters (as defined in Section 2.2) are not in the scope of this

UTP.

TSI. When they are intended to operate on the Union railway network (movement between shunting yards, stations and depots), Article 1.4(b) of Directive (EU) 2016/797 applies.

 OTIF	Uniform Technical Prescription (UTP)		UTP LOC&PAS	
	LOCOMOTIVES AND PASSENGER ROLLING STOCK		Page 17 of 272	
Status: DRAFT	Version: 03	TECH-20041 Annex	Original: EN	Date: 20.10.2020

(2) ~~A)~~ Self-propelling thermal ~~and~~/or electric [passenger](#) trains:

This type includes any train in fixed or pre-defined formation, composed of vehicles passenger carrying and/or vehicles not carrying passengers.

Thermal or electric traction equipment is installed in some vehicles of the train, and the train is fitted with a driver's cab.

Exclusion from the scope:

[\(reserved\)](#)

[In accordance with Articles 1.3, 1.4\(d\) and 1.5 of Directive \(EU\) 2016/797, the following rolling stock is excluded from the scope of the TSI:](#)

- [Rolling stock intended to operate on local, urban or suburban networks functionally separate from the rest of the railway system.](#)
- [Rolling stock primarily used on light rail infrastructure but equipped with some heavy rail components necessary to enable transit to be effected on a confined and limited section of heavy rail infrastructure for connectivity purposes only.](#)
- [Tram – trains.](#)

~~— Railcars or Electric and/or Diesel Multiple Units intended to operate on explicitly identified local, urban or suburban networks functionally separate from the rest of the railway system are not in the scope of this~~

~~UTP.~~

~~TSI.~~

~~— Rolling stock which is designed to operate primarily on urban metro, tramway or other light rail networks is not in the scope of this~~

~~UTP.~~

~~TSI.~~

~~These types of rolling stock~~

~~may be admitted to international operation by application of ATMF Article 6 § 4.~~

~~may be authorised to operate on particular sections of the Union railway network that are identified for this purpose (due to the local configuration of the railway network) by reference to the Register of Infrastructure.~~

~~In that case, and provided that they are not explicitly excluded from the scope of Directive 2008/57/EC, Articles 24 and 25 of Directive 2008/57/EC (referring to national rules) are applicable.~~

 OTIF	Uniform Technical Prescription (UTP)		UTP LOC&PAS	
	LOCOMOTIVES AND PASSENGER ROLLING STOCK		Page 18 of 272	
Status: DRAFT	Version: 03	TECH-20041 Annex	Original: EN	Date: 20.10.2020

~~B) Thermal and/or electric traction units:~~

~~This type includes traction vehicles that are not capable of carrying a payload, such as thermal or electric locomotives or power units.~~

~~The concerned traction vehicles are intended for freight or/and passenger transport.~~

~~Exclusion from the scope:~~

~~Shunters (as defined in Section 2.2) are not in the scope of this~~

~~UTP:~~

~~TSI; when they are intended to operate on the Union railway network (movement between shunting yards, stations and depots), Articles 24 and 25 of Directive 2008/57/EC (referring to national rules) are applicable.~~

(3) **~~C) Passenger carriages/coaches~~** and other related cars:

Passenger carriages:

This type includes vehicles without traction carrying passengers (coaches, as defined in Section 2.2), and operated in a variable formation with vehicles from the category “thermal or electric traction units” defined above to provide the traction function.

Non-passenger carrying vehicles included in a passenger train:

This type includes vehicles without traction included in passenger trains (e.g. luggage or postal vans, car carriers, vehicles for service...); they are in the scope of this

UTP

~~TSI~~

as vehicles related to transport of passengers.

B) Freight wagons, including low-deck vehicles designed for the entire network and vehicles designed to carry lorries

Exclusion from the scope:

Freight wagons are not in the scope of this

UTP;

~~TSI;~~

they are covered by the

UTP WAG

~~“freight wagons” TSI~~

even when they are included in a passenger train (the train composition is in this case an operational issue).

Vehicles intended to carry road motor vehicles (with persons on-board these road motor vehicles) are not in the scope of this

UTP;

~~TSI;~~

 OTIF	Uniform Technical Prescription (UTP)		UTP LOC&PAS	
	LOCOMOTIVES AND PASSENGER ROLLING STOCK		Page 19 of 272	
Status: DRAFT	Version: 03	TECH-20041 Annex	Original: EN	Date: 20.10.2020

~~when they are intended to operate~~

~~in international traffic, Article 6 § 4 of ATMF is applicable.~~

~~on the Union railway network Articles 24 and 25 of Directive 2008/57/EC (referring to national rules) are applicable.~~

C) ~~D) Special vehicles, such as on-track machines~~ ~~Mobile railway infrastructure construction and maintenance equipment~~

This type of rolling stock is in the scope of the

UTP

~~TSI~~

only when:

- It is running on its own rail wheels; and
- It is designed and intended to be detected by a track based train detection system for traffic management; and
- In case of OTMs, it is in transport (running) configuration, self-propelled or hauled.

Exclusion from the scope:

In case of OTMs, working configuration is outside the scope of this

UTP.

~~TSI.~~

2.3.2 Track gauge

This

UTP

~~TSI~~

is applicable to rolling stock which is intended to be operated on networks of track gauge

1435 mm, 1520 mm, 1524 mm, 1600 mm and 1668 mm.

1435 mm, or on one of the following nominal track gauges: 1520 mm, 1524 mm system, 1600 mm system and 1668 mm system.

~~The applicability of requirements to vehicles designed to be operated only on networks outside the European Union with a nominal track gauge of 1520 mm is not mandatory.~~

~~Contracting States may agree to apply this UTP to vehicles admitted to international operation on 1520 mm networks. If this UTP is not applied to vehicles designed to operate on 1520 mm networks, the requirements for these vehicles are an open point, and such vehicles are therefore subject to admission in accordance with ATMF Article 6 § 4.~~

 OTIF	Uniform Technical Prescription (UTP)		UTP LOC&PAS	
	LOCOMOTIVES AND PASSENGER ROLLING STOCK		Page 20 of 272	
Status: DRAFT	Version: 03	TECH-20041 Annex	Original: EN	Date: 20.10.2020

2.3.3 Maximum speed

For the application of this UTP,

Considering the integrated railway system composed of several subsystems (in particular fixed installations; see Section 2.1),

the maximum design speed of rolling stock is deemed to be lower or equal to 350 km/h.

In case of maximum design speed higher than 350 km/h, this technical specification applies, but has to be complemented for the speed range above 350 km/h (or maximum speed related to a particular parameter, where specified in the relevant point of section 4.2) up to the maximum design speed, by application of the procedure for innovative solutions described in

section 6.2.5.

Article 10.

3. ESSENTIAL REQUIREMENTS

3.1 Elements of the rolling stock subsystem corresponding to the essential requirements

The following table indicates the essential requirements, as set out and numbered in

UTP GEN-A⁶,

Annex III ~~to~~ Directive [\(EU\) 2016/797](#)~~2008/57/EC~~,

taken into account by the specifications set out in Chapter 4 of this

UTP.

~~TSI~~

Rolling stock elements corresponding to essential requirements

Note: only points in section 4.2 which contain requirements are listed.

Ref. Point	Element of the rolling stock subsystem	Safety	Reliability-Availability	Health	Environmental protection	Technical compatibility
4.2.2.2.2	Inner coupling	1.1.3 2.4.1				
4.2.2.2.3	End coupling	1.1.3 2.4.1				
4.2.2.2.4	Rescue coupling		2.4.2			2.5.3
4.2.2.2.5	Staff access for coupling and uncoupling	1.1.5		2.5.1		2.5.3
4.2.2.3	Gangways	1.1.5				
4.2.2.4	Strength of vehicle structure	1.1.3 2.4.1				

⁶ Essential requirements – General Provisions, UTP [GEN-A](#), ~~APTU (A 94 01A/1.2011)~~



Ref. Point	Element of the rolling stock sub-system	Safety	Reliability-Availability	Health	Environmental protection	Technical compatibility
4.2.2.5	Passive safety	2.4.1				
4.2.2.6	Lifting and jacking					2.5.3
4.2.2.7	Fixing of devices to carbody structure	1.1.3				
4.2.2.8	Staff and freight access doors	1.1.5 2.4.1				
4.2.2.9	Mechanical characteristics of glass	2.4.1				
4.2.2.10	Load conditions and weighted mass	1.1.3				
4.2.3.1	Gauging					2.4.3
4.2.3.2.1	Axle load parameter					2.4.3
4.2.3.2.2	Wheel load	1.1.3				
4.2.3.3.1	Rolling stock characteristics for compatibility with train detection systems	1.1.1				2.4.3 2.3.2
4.2.3.3.2	Axle bearing condition monitoring	1.1.1	1.2			
4.2.3.4.1	Safety against derailment running on twisted track	1.1.1 1.1.2				2.4.3
4.2.3.4.2	Running dynamic behaviour	1.1.1 1.1.2				2.4.3
4.2.3.4.2.1	Limit values for running safety	1.1.1 1.1.2				2.4.3
4.2.3.4.2.2	Track loading limit values					2.4.3
4.2.3.4.3	Equivalent conicity	1.1.1 1.1.2				2.4.3
4.2.3.4.3.1	Design values for new wheel profiles	1.1.1 1.1.2				2.4.3
4.2.3.4.3.2	In-service values of wheelset equivalent conicity	1.1.2	1.2			2.4.3
4.2.3.5.1	Structural design of bogie frame	1.1.1 1.1.2				



Ref. Point	Element of the rolling stock sub-system	Safety	Reliability-Availability	Health	Environmental protection	Technical compatibility
4.2.3.5.2.1	Mechanical and geometrical characteristics of wheelsets	1.1.1 1.1.2				2.4.3
4.2.3.5.2.2	Mechanical and geometrical characteristics of wheels	1.1.1 1.1.2				
4.2.3.5.2.3	Variable gauge wheelsets <u>Automatic variable gauge wheelsets systems</u>	1.1.1 1.1.2 <u>1.1.3</u>	<u>1.2</u>			<u>1.5</u>
4.2.3.6	Minimum curve radius	1.1.1 1.1.2				2.4.3
4.2.3.7	Life guards	1.1.1				
4.2.4.2.1	Braking – Functional requirements	1.1.1 2.4.1	2.4.2			1.5
4.2.4.2.2	Braking – Safety requirements	1.1.1	1.2 2.4.2			
4.2.4.3	Type of brake system					2.4.3
4.2.4.4.1	Emergency braking command	2.4.1				2.4.3
4.2.4.4.2	Service braking command					2.4.3
4.2.4.4.3	Direct braking command					2.4.3
4.2.4.4.4	Dynamic braking command	1.1.3				
4.2.4.4.5	Parking braking command					2.4.3
4.2.4.5.1	Braking performance – General requirements	1.1.1 2.4.1	2.4.2			1.5
4.2.4.5.2	Emergency braking	1.1.2 2.4.1				2.4.3
4.2.4.5.3	Service braking					2.4.3
4.2.4.5.4	Calculations related to thermal capacity	2.4.1				2.4.3
4.2.4.5.5	Parking brake	2.4.1				2.4.3
4.2.4.6.1	Limit of wheel rail adhesion profile	2.4.1	1.2 2.4.2			
4.2.4.6.2	Wheel slide protection system	2.4.1	1.2 2.4.2			



Ref. Point	Element of the rolling stock sub-system	Safety	Reliability-Availability	Health	Environmental protection	Technical compatibility
4.2.4.7	Dynamic brake – Braking systems linked to traction system	2.4.1	1.2 2.4.2			
4.2.4.8.1.	Braking system independent of adhesion conditions – General	2.4.1	1.2 2.4.2			
4.2.4.8.2.	Magnetic track brake					2.4.3
4.2.4.8.3	Eddy current track brake					2.4.3
4.2.4.9	Brake state and fault indication	1.1.1	1.2 2.4.2			
4.2.4.10	Brake requirements for rescue purposes		2.4.2			
4.2.5.1	Sanitary systems				1.4.1	
4.2.5.2	Public address system: a Audible communication system	2.4.1				
4.2.5.3	Passenger alarm	2.4.1				
4.2.5.4	Communication devices for passengers	2.4.1				
4.2.5.5	Exterior doors: access to and egress from Rolling stock	2.4.1				
4.2.5.6	Exterior doors: system construction	1.1.3 2.4.1				
4.2.5.7	inter-unit doors	1.1.5				
4.2.5.8	Internal air quality			1.3.2		
4.2.5.9	body side windows	1.1.5				
4.2.6.1	Environmental conditions		2.4.2			
4.2.6.2.1	Slipstream effects on passengers on platform and on workers at track side	1.1.1		1.3.1		



Ref. Point	Element of the rolling stock sub-system	Safety	Reliability-Availability	Health	Environmental protection	Technical compatibility
4.2.6.2.2	Head pressure pulse					2.4.3
4.2.6.2.3	Maximum pressure variations in tunnels					2.4.3
4.2.6.2.4	Cross wind	1.1.1				
4.2.6.2.5	Aerodynamic effect on ballasted track	1.1.1				2.4.3
4.2.7.1.1	Head lights					2.4.3
4.2.7.1.2	Marker lights	1.1.1				2.4.3
4.2.7.1.3	Tail lights	1.1.1				2.4.3
4.2.7.1.4	Lamp controls					2.4.3
4.2.7.2.1	Horn – General	1.1.1				2.4.3 2.6.3
4.2.7.2.2	Warning horn sound pressure levels	1.1.1		1.3.1		
4.2.7.2.3	Protection					2.4.3
4.2.7.2.4	Horn control	1.1.1				2.4.3
4.2.8.1	Traction performance					2.4.3 2.6.3
4.2.8.2 4.2.8.2.1 to 4.2.8.2.9	Power supply					1.5 2.4.3 2.2.3
4.2.8.2.10	Electrical protection of the train	2.4.1				
4.2.8.3	Diesel and other thermal traction system	2.4.1				1.4.1
4.2.8.4	Protection against electrical hazards	2.4.1				
4.2.9.1.1	Driver's cab – General	-	-	-	-	-
4.2.9.1.2	Access and egress	1.1.5				2.4.3
4.2.9.1.3	External visibility	1.1.1				2.4.3
4.2.9.1.4	Interior layout	1.1.5				
4.2.9.1.5	Driver's seat			1.3.1		
4.2.9.1.6	Driver's desk – Ergonomics	1.1.5		1.3.1		
4.2.9.1.7	Climate control and air quality			1.3.1		
4.2.9.1.8	Internal lighting					2.6.3



Ref. Point	Element of the rolling stock sub-system	Safety	Reliability-Availability	Health	Environmental protection	Technical compatibility
4.2.9.2.1	Windscreen – Mechanical characteristics	2.4.1				
4.2.9.2.2	Windscreen – Optical characteristics					2.4.3
4.2.9.2.3	Windscreen – Equipment					2.4.3
4.2.9.3.1	Driver’s activity control function	1.1.1				2.6.3
4.2.9.3.2	Speed indication	1.1.5				
4.2.9.3.3	Driver display unit and screens	1.1.5				
4.2.9.3.4	Controls and indicators	1.1.5				
4.2.9.3.5	Labelling					2.6.3
4.2.9.3.6	Radio remote control function by staff for shunting operation	1.1.1				
4.2.9.4	Onboard tools and portable equipment	2.4.1				2.4.3 2.6.3
4.2.9.5	Storage facility for staff personal effects	-	-	-	-	-
4.2.9.6	Recording device					2.4.4
4.2.10.2	Fire safety – Measures to prevent fire	1.1.4		1.3.2	1.4.2	
4.2.10.3	Measures to detect/control fire	1.1.4				
4.2.10.4	Requirements related to emergency situations	2.4.1				
4.2.10.5	Requirements related to evacuation	2.4.1				
4.2.11.2	Train exterior cleaning					1.5
4.2.11.3	Connection to toilet discharge system					1.5
4.2.11.4	Water refilling equipment			1.3.1		

Ref. Point	Element of the rolling stock sub-system	Safety	Reliability-Availability	Health	Environmental protection	Technical compatibility
4.2.11.5	Interface for water refilling					1.5
4.2.11.6	Special requirements for stabling of trains					1.5
4.2.11.7	Refuelling equipment					1.5
4.2.11.8	Train interior cleaning – power supply					2.5.3
4.2.12.2	General documentation					1.5
4.2.12.3	Documentation related to maintenance	1.1.1				2.5.1 ² 2.5.2 2.6.1 2.6.2
4.2.12.4	Operating documentation	1.1.1				2.4.2 2.6.1 2.6.2
4.2.12.5	Lifting diagram and instructions					2.5.3
4.2.12.6	Rescue related descriptions		2.4.2			2.5.3

3.2 Essential requirements not covered by this [UTP](#)

UTP

TSI

Some of the essential requirements classified as “general requirements” or “specific to other subsystems” in

UTP GEN-A

Annex III ~~to~~ Directive [\(EU\) 2016/797/2008/57/EC](#)

have an impact on the rolling stock subsystem; those that are not covered, or are covered with limitations within the scope of this

UTP

TSI

are identified below.

² In the EU TSI additional reference is made to 2.5.2, however Essential Requirement 2.5.2 (environmental protection in the scope of maintenance) does not exist in COTIF as it is beyond its scope.

 OTIF	Uniform Technical Prescription (UTP)		UTP LOC&PAS	
	LOCOMOTIVES AND PASSENGER ROLLING STOCK		Page 27 of 272	
Status: DRAFT	Version: 03	TECH-20041 Annex	Original: EN	Date: 20.10.2020

3.2.1 General requirements, requirements related to maintenance and operation

The numbering of the paragraphs and the essential requirements hereunder are those set out in

UTP GEN-A.

Annex III ~~to~~ Directive [\(EU\) 2016/797](#) ~~2008/57/EC~~.

The essential requirements that are not covered within the scope of this

UTP should be assessed by other means [by the Contracting State which issues the initial admission of a vehicle](#).

TSI

In accordance with UTP GEN-D, at the first (and if applicable consecutive) admission to operation, the Contracting State must take all appropriate steps to ensure that the vehicle is designed and constructed in such a way that it meets the essential requirements when integrated into the rail system. If neither the UTP nor the notified national rules provide an adequate basis for full assessment of compliance with the essential requirements, an explicit risk assessment and evaluation in accordance with UTP GEN-G⁸ must be performed.

The essential requirements concerned

are the following:

1.4.Environmental protection

1.4.1 *“The environmental impact of establishment and operation of the rail system must be assessed and taken into account at the design stage of the system in accordance with the*

Provisions in force in the State of application.” *Community provisions in force.”*

This essential requirement

shall be covered by rules notified in accordance with APTU Article 12 and applicable in the Contracting State where the vehicle is admitted for operation.

is covered by the relevant European provisions in force

European law is applicable to vehicles intended to be operated on the territory of the European Union.

⁸ [Common safety method \(CSM\) on Risk evaluation and assessment \(RA\) – General Provisions, UTP GEN-G as last amended on 1 December 2016](#), ~~APTU~~ (A 94-01G/1.2012)

 OTIF	Uniform Technical Prescription (UTP)		UTP LOC&PAS	
	LOCOMOTIVES AND PASSENGER ROLLING STOCK		Page 28 of 272	
Status: DRAFT	Version: 03	TECH-20041 Annex	Original: EN	Date: 20.10.2020

- 1.4.3 *“The rolling stock and energy-supply systems must be designed and manufactured in such a way as to be electromagnetically compatible with the installations, equipment and public or private networks with which they might interfere.”*

This essential requirement

shall be covered by rules notified in accordance with APTU Article 12 and applicable in the Contracting State where the vehicle is admitted for operation.

European law is applicable to vehicles intended to be operated on the territory of the European Union.

is covered by the relevant European provisions in force

- 1.4.4 *“Operation of the rail system must respect existing regulations on noise pollution.”*

This essential requirement is covered at vehicle level by the UTP NOI. For vehicles outside the scope of the UTP NOI, noise emission is an open point and may be covered by rules notified in accordance with APTU Article 12 and applicable in the Contracting State where the vehicle is admitted for operation.

This essential requirement is covered by the relevant European provisions in force. (in particular Noise TSI, and HS RST TSI 2008 until all rolling stock are covered by the Noise TSI).

- 1.4.5 *“Operation of the rail system must not give rise to an inadmissible level of ground vibrations for the activities and areas close to the infrastructure and in a normal state of maintenance.”*

This essential requirement is in the scope of the Infrastructure.

2.5.Maintenance

These essential requirements are relevant within the scope of this

UTP

TSI

according to Section 3.1 of this

UTP

TSI

only for the technical maintenance documentation related to the rolling stock subsystem; they are not covered within the scope of this

UTP

TSI

regarding maintenance installations.

2.6.Operation

These essential requirements are relevant within the scope of this

UTP

TSI

 OTIF	Uniform Technical Prescription (UTP)		UTP LOC&PAS	
	LOCOMOTIVES AND PASSENGER ROLLING STOCK		Page 29 of 272	
Status: DRAFT	Version: 03	TECH-20041 Annex	Original: EN	Date: 20.10.2020

according to Section 3.1 of this

UTP

~~TSI~~

for the operating documentation related to the rolling stock subsystem (essential requirements 2.6.1 and 2.6.2), and for technical compatibility of the rolling stock with operating rules (essential requirements 2.6.3).

3.2.2 Requirements specific to other subsystems

Requirements on the relevant other sub-systems are necessary to fulfil these essential requirements for the whole railway system.

The requirements on the rolling stock subsystem which contribute to the fulfilment of these essential requirements are mentioned in the section 3.1 of this

UTP;

~~TSI;~~

corresponding essential requirements are those set out in sections 2.2.3 and 2.3.2 of

UTP GEN-A,

Annex III ~~to~~ Directive [\(EU\) 2016/797](#) ~~2008/57/EC~~,

Other essential requirements are not covered within the scope of this

UTP.

~~TSI.~~

4. CHARACTERISATION OF THE ROLLING STOCK SUBSYSTEM

4.1 Introduction

4.1.1 General

(1) The

Union's

rail system, to which

APTU and ATMF apply, is defined by means of subsystems as set out in UTP GEN-B. The consistency between the different subsystems

Directive [\(EU\) 2016/797](#) ~~2008/57/EC~~ applies and of which the rolling stock subsystem is a part, is an integrated system whose consistency

needs to be verified. This consistency must be checked in particular with regard to the specifications of the rolling stock subsystem, its interfaces with the other subsystems

of the Union's rail system in which it is integrated,

as well as the operating and maintenance rules.

(2) The basic parameters of the rolling stock sub-system are defined in the present Chapter 4 of this

 OTIF	Uniform Technical Prescription (UTP)		UTP LOC&PAS	
	LOCOMOTIVES AND PASSENGER ROLLING STOCK		Page 30 of 272	
Status: DRAFT	Version: 03	TECH-20041 Annex	Original: EN	Date: 20.10.2020

UTP.

~~TSI~~

(3) Except where this is strictly necessary for

international traffic,

the interoperability of the Union's rail system,

the functional and technical specifications of the subsystem and its interfaces described in Sections 4.2 and 4.3, do not impose the use of specific technologies or technical solutions.

(4) Some of the rolling stock characteristics that are mandated to be recorded in the

Registers, according to Article 13§1 of ATMF

“European register of authorised types of vehicles” (according to the relevant Commission Decision)

are described in Sections 4.2 and 6.2 of this

UTP.

~~TSI~~

Additionally, these characteristics are required to be provided in the rolling stock technical documentation described in point 4.2.12 of this

UTP.

~~TSI~~

4.1.2 Description of the Rolling stock subject to the application of this

UTP

TSI

(1) Rolling stock subject to the application of this

UTP

~~TSI~~

(designated as a unit in the context of this

UTP)

~~TSI~~

shall be described in the

UTP certificate of verification in accordance with UTP GEN-D,

~~certificate of “EC” verification,~~

using one of the following characteristics:

- Trainset in fixed formation and, when required, predefined formation(s) of several trainsets of the type under assessment for multiple operation.
- Single vehicle or fixed rakes of vehicles intended for predefined formation(s).
- Single vehicle or fixed rakes of vehicles intended for general operation and when required, predefined formation(s) of several vehicles (locomotives) of the type under assessment for multiple operation.

 OTIF	Uniform Technical Prescription (UTP)		UTP LOC&PAS	
	LOCOMOTIVES AND PASSENGER ROLLING STOCK		Page 31 of 272	
Status: DRAFT	Version: 03	TECH-20041 Annex	Original: EN	Date: 20.10.2020

Note: Multiple operation of the unit under assessment with other types of rolling stock is not in the scope of this

- | | | |
|-----|--|--|
| | UTP. | TSI |
| (2) | Definitions related to train formation and units are given in Section 2.2 of this | |
| | UTP. | TSI |
| (3) | When a unit intended for use in fixed or predefined formation(s) is assessed, the formation(s) for which such assessment is valid shall be defined by the party asking for assessment, and stated in the | |
| | UTP certificate of verification. | certificate of "EC" verification. |

The definition of each formation shall include the type designation of each vehicle (or of vehicle bodies and wheelsets in case of articulated fixed formation), and their arrangement in the formation. Additional details are given in clauses 6.2.8 & 9.

- (4) Some characteristics or some assessments of a unit intended to be used in general operation, will require defined limits regarding the train formations. These limits are laid down in Section 4.2 and in clause 6.2.7.

4.1.3 Main categorisation of the rolling stock for application of

- | | | |
|-----|--|--|
| | UTP | TSI |
| | Requirements | |
| (1) | A rolling stock technical categorisation system is used in the following clauses of this | |
| | UTP | TSI |
| | to define relevant requirements applicable to a unit. | |
| (2) | The technical category(ies) relevant for the unit subject to the application of this | |
| | UTP | TSI |
| | shall be identified by the party asking for assessment. This categorisation shall be used by the | |
| | assessing entity | notified body |
| | in charge of the assessment, in order to assess the applicable requirements from this | |
| | UTP, | TSI |
| | and shall be stated in the | |
| | UTP certificate of verification. | certificate of "EC" verification. |
| (3) | The technical categories of rolling stock are the following: | |

 OTIF	Uniform Technical Prescription (UTP)		UTP LOC&PAS	
	LOCOMOTIVES AND PASSENGER ROLLING STOCK		Page 32 of 272	
Status: DRAFT	Version: 03	TECH-20041 Annex	Original: EN	Date: 20.10.2020

- Unit designed to carry passengers
- Unit designed to carry passenger-related load (luggage, cars, etc.)
- Unit designed to carry other payload (mail, freight, etc.) in self-propelling trains
- Unit fitted with a driver’s cab
- Unit fitted with traction equipment
- Electric unit, defined as a unit supplied with electric energy by electrification system(s) with an overhead contact line. | specified in the ENE TSI.
- Thermal traction unit
- Freight locomotive: Unit designed to haul freight wagons
- Passenger locomotive: Unit designed to haul passenger carriages
- OTMs
- Infrastructure inspection vehicles.

A unit is characterised by one or several of the categories above.

(4) Unless stated otherwise in the clauses of Section 4.2, requirements specified in this

UTP | ~~TSI~~

apply to all technical categories of rolling stock defined above.

(5) The unit operational configuration shall also be considered when it is assessed; a distinction shall be made between:

- A unit that can be operated as a train.
- A unit that cannot be operated alone, and that has to be coupled with other unit(s) to be operated as a train (see also clauses 4.1.2, 6.2.7 and 6.2.8).

(6) The maximum design speed of the unit subject to the application of this

UTP | ~~TSI~~

shall be declared by the party asking for assessment; it shall be a multiple of 5 km/h (see also clause 4.2.8.1.2) when its value is higher than 60 km/h; it shall be used by the

assessing entity | ~~notified body~~

in charge of the assessment, in order to assess the applicable requirements from this

UTP, | ~~TSI,~~

and shall be stated in the

UTP certificate of verification. | ~~certificate of “EC” verification.~~

4.1.4 Categorisation of the rolling stock for fire safety

 OTIF	Uniform Technical Prescription (UTP)		UTP LOC&PAS	
	LOCOMOTIVES AND PASSENGER ROLLING STOCK		Page 33 of 272	
Status: DRAFT	Version: 03	TECH-20041 Annex	Original: EN	Date: 20.10.2020

(1) In respect of fire safety requirements, four categories of rolling stock are defined

which are specified as:

- Category A passenger rolling stock (including passenger locomotive),
- Category B passenger rolling stock (including passenger locomotive),
- Freight locomotive, and self-propelling unit designed to carry other payload than passenger (mail, freight, infrastructure inspection vehicle, etc.),
- OTMs.

and specified in the SRT TSI:

(2) The compatibility between the category of the unit and its operation in tunnels

is presumed to be defined in each Contracting State by the competent authority in such a way that for each tunnel on lines used for international traffic it is specified which category of rolling stock, in accordance with this UTP, may be operated in the tunnel. When defining this compatibility, the competent authority shall observe the principle that rolling stock of category B of tunnel safety (highest category) is permitted to run in all tunnels, and rolling stock of category A is permitted to run in tunnels with a length of 5 km (or less), without prejudice to specific cases.

The measures for running capability specified in point 4.2.10.4.4 permit trains of category B to continue running for 15 minutes and to reach a safe area within 20 km, assuming the train is able to run at 80 km/h. If it is not possible for the train to leave the tunnel, it will be evacuated using the infrastructure facilities (safe area) provided in the tunnel.

The competent authority shall ensure that a tunnel emergency plan, including the relevant evacuation procedures, is available.

is set out in the SRT TSI

(3) For units designed to carry passengers or haul passenger carriages, and subject to the application of this

UTP,

~~TSI~~,

category A is the minimum category to be selected by the party asking for assessment;

units designed to carry passengers and to be operated in tunnels with a length of more than 5 km shall be assessed against the requirements applicable to category B.

the criteria for selecting category B are given in the SRT TSI.

(4) This categorisation shall be used by the

 OTIF	Uniform Technical Prescription (UTP)		UTP LOC&PAS	
	LOCOMOTIVES AND PASSENGER ROLLING STOCK		Page 34 of 272	
Status: DRAFT	Version: 03	TECH-20041 Annex	Original: EN	Date: 20.10.2020

assessing entity

~~notified body~~

in charge of the assessment, in order to assess the applicable requirements from the clause 4.2.10 of this

UTP

~~TSI~~

and shall be stated in the

UTP certificate of verification.

~~certificate of "EC" verification.~~

4.2 Functional and technical specification of the sub-system

4.2.1 General

4.2.1.1 Breakdown

(1) The functional and technical specifications of the rolling stock subsystem are grouped and sorted out in the following clauses of this section:

- Structures and mechanical parts
- Track interaction and gauging
- Braking
- Passenger related items
- Environmental conditions
- External lights & audible and visible warning devices
- Traction and electrical equipment
- Driver's cab and driver-machine interface
- Fire safety and evacuation
- Servicing
- Documentation for operation and maintenance

(2) For particular technical aspects specified in chapters 4, 5 and 6, the functional and technical specification makes an explicit reference to a clause of an EN standard or other technical document,

as allowed by Article ~~54~~(8) of Directive [\(EU\) 2016/797](#)~~2008/57/EC~~;

these references are listed in the Appendix J of this

UTP.

~~TSI~~

(3) Information needed on board for the train staff to be aware of the operational state of the train (normal state, equipment out of order, degraded situation ...) are described in the clause dealing with the relevant function, and in clause 4.2.12 "documentation for the operation and maintenance".

 OTIF	Uniform Technical Prescription (UTP)		UTP LOC&PAS	
	LOCOMOTIVES AND PASSENGER ROLLING STOCK		Page 35 of 272	
Status: DRAFT	Version: 03	TECH-20041 Annex	Original: EN	Date: 20.10.2020

4.2.1.2 Open points

- (1) When, for a particular technical aspect, the functional and technical specification necessary to meet the essential requirements has not been yet developed, and therefore is not included in this

UTP,

~~TSI~~

this aspect is identified as an open point in the relevant clause; Appendix I of this

UTP

~~TSI~~

lists all open points, as required in

Article 8§7 of APTU.

Article ~~54~~(6) of Directive [\(EU\) 2016/797](#)~~2008/57/EC~~.

The Appendix I mentions also if the open points relate to technical compatibility with the network; for this purpose, the Appendix I is split in 2 parts:

- Open points that relate to technical compatibility between the vehicle and the network.
- Open points that do not relate to technical compatibility between the vehicle and the network.

- (2) As required in

APTU Article 12 [§ 2](#) and ATMF Article 7 § 2,

Articles ~~54~~(6) and ~~173~~(~~32~~) of Directive [\(EU\) 2016/797](#)~~2008/57/EC~~,

open points shall be addressed by the application of national technical rules.

4.2.1.3 Safety aspects

- (1) The functions that are essential to safety are identified in Section 3.1 of this

UTP

~~TSI~~

by their link to the essential requirements “safety”.

- (2) Safety requirements related to these functions are covered by the technical specifications expressed in the corresponding clause of Section 4.2 (e.g. “passive safety”, “wheels” ...).
- (3) Where these technical specifications need to be complemented by requirements expressed in terms of safety requirements (severity level), they are also specified in the corresponding clause of Section 4.2.
- (4) Electronic devices and software, which are used to fulfil functions essential to safety shall be developed and assessed according to a methodology adequate for safety related electronic devices and software.

4.2.2 Structure and mechanical parts

4.2.2.1 General

- (1) This part addresses requirements relating to the design of vehicle structural body (strength of vehicle structure) and of the mechanical links (mechanical interfaces) between vehicles or between units.

 OTIF	Uniform Technical Prescription (UTP)		UTP LOC&PAS	
	LOCOMOTIVES AND PASSENGER ROLLING STOCK		Page 36 of 272	
Status: DRAFT	Version: 03	TECH-20041 Annex	Original: EN	Date: 20.10.2020

- (2) Most of these requirements aim at ensuring the train's mechanical integrity in operation and rescue operation as well as protecting passenger and staff compartments in the event of collision or derailment.

4.2.2.2 Mechanical interfaces

4.2.2.2.1 General and definitions

In order to form a train (as defined in section 2.2) vehicles are coupled together in a way that enables them to be operated together. The coupling is the mechanical interface that enables this. There are several types of couplings:

- (1) "Inner" coupling (also called "intermediate" coupling) is the coupling device between vehicles in order to form a unit composed of several vehicles (e.g. a fixed rake of coaches or a trainset)
- (2) End coupling ("external" coupling) of units is the coupling device used to couple together two (or several) units to form a train. An end coupling can be 'automatic', 'semi-automatic' or 'manual'. An end coupling can be used for rescue purpose (see clause 4.2.2.2.4). In the context of this

UTP

TSI

a 'Manual' coupling is an end coupling system which requires (one or several) person(s) to stand between the units to be coupled or uncoupled for the mechanical coupling of these units.

- (3) Rescue coupling is the coupling device that enables a unit to be rescued by a recovery power unit equipped with a 'standard' manual coupling as per clause 4.2.2.2.3 where the unit to be rescued is equipped with a different coupling system or is not equipped with any coupling system.

4.2.2.2.2 Inner coupling

- (1) Inner couplings between the different vehicles (fully supported by their own wheels) of a unit shall incorporate a system capable of withstanding the forces due to the intended operating conditions.
- (2) Where the inner coupling system between vehicles has a lower longitudinal strength than the end coupling(s) of the unit, provisions shall be made to rescue the unit in case of breakage of any such inner coupling; these provisions shall be described in the documentation required in clause 4.2.12.6.
- (3) In case of articulated units, the joint between two vehicles sharing the same running gear shall comply with the requirements of the specification referenced in Appendix J-1, index 1.

4.2.2.2.3 End coupling

a) General Requirements

a-1) Requirements on characteristics of end coupling

- (1) Where an end coupling is provided at any end of a unit, the following requirements apply to all types of end coupling (automatic, semi-automatic or manual):
- End couplings shall incorporate a resilient coupling system, capable of withstanding the forces due to the intended operational and rescue conditions.
 - The type of mechanical end coupling together with its nominal maximum design values of tensile and compressive forces and the height above rail level of its centre line (unit in working

 OTIF	Uniform Technical Prescription (UTP)		UTP LOC&PAS	
	LOCOMOTIVES AND PASSENGER ROLLING STOCK		Page 37 of 272	
Status: DRAFT	Version: 03	TECH-20041 Annex	Original: EN	Date: 20.10.2020

order with new wheels) shall be recorded in the technical documentation described in clause 4.2.12.

- (2) Where there is no coupling at any end of a unit, a device to allow a rescue coupling shall be provided at such end of the unit.

a-2) Requirements on type of end coupling

- (1) Units assessed in fixed or predefined formation, and of maximum design speed higher or equal to 250 km/h, shall be equipped at each end of the formation with an automatic centre buffer coupler geometrically and functionally compatible with a “Type 10 latch system automatic centre buffer coupler” (as defined in clause 5.3.1); the height above rail of its coupling centre line shall be 1025 mm + 15 mm /- 5 mm (measured with new wheels in load condition “design mass in working order”).
- (2) Units designed and assessed for general operation and designed to be operated solely on the 1520 mm system shall be fitted with a centre buffer coupler geometrically and functionally compatible with a “SA3 coupling”; the height above rail of its coupling centre line shall be between 980 to 1080 mm (for all wheel and load conditions).

b) Requirements on “Manual” coupling system

b-1) Provisions to units

- (1) The following provisions apply specifically to units fitted with a “Manual” coupling system:
- The coupling system shall be designed so that no human presence between the units to be coupled / uncoupled is required whilst either one is moving.
 - For units designed and assessed to be operated in ‘general operation’ or in ‘predefined formation’, and fitted with a manual coupling system, this coupling system shall be of UIC type (as defined in clause 5.3.2).
- (2) These units shall comply with the additional requirements of point b-2) below.

b-2) Compatibility between units

On units equipped with manual coupling system of UIC type (as described in clause 5.3.2) and pneumatic brake system compatible with UIC type (as described in clause 4.2.4.3), the following requirements apply:

- The buffers and the screw coupling shall be installed according to clauses ~~5 and 6 of the specification referenced in Appendix J-1, index 110~~ A.1 to A.3 of Appendix A.
- ~~The dimensions and layout of brake pipes and hoses, couplings and cocks shall meet the following requirements set in clauses 7 and 8 of the specification referenced in Appendix J-1, index 110.~~
- ~~The interface of the brake pipe and main reservoir pipe shall be as set out in the specification referenced in Appendix J-1, index 2.~~
- ~~The opening of the automatic air brake coupling head shall face the left when looking at the end of the vehicle.~~

 OTIF	Uniform Technical Prescription (UTP)		UTP LOC&PAS	
	LOCOMOTIVES AND PASSENGER ROLLING STOCK		Page 38 of 272	
Status: DRAFT	Version: 03	TECH-20041 Annex	Original: EN	Date: 20.10.2020

- ~~• The opening of the main reservoir coupling head shall face the right when looking at the end of the unit.~~
- ~~• The end cocks shall be in accordance with the specification referenced in Appendix J-1, index 3.~~
- ~~The lateral location of brake pipes and cocks shall be compatible with the requirements of the specification referenced in Appendix J-1, index 4.~~

4.2.2.2.4 Rescue coupling

- (1) Provisions shall be made to enable the recovery of the line in case of breakdown by hauling or propelling the unit to be rescued.
- (2) Where the unit to be rescued is fitted with an end coupling, rescue shall be possible by means of a power unit equipped with the same type of end coupling system (including compatible height above rail level of its centre line).
- (3) For all units, rescue shall be possible by means of a recovery unit i.e. a power unit featuring at each of its ends intended to be used for rescue purposes:
 - a) On 1435 mm, 1524 mm, 1600 mm or 1668 mm systems:
 - A manual coupling system of UIC type (as described in clauses 4.2.2.2.3 and 5.3.2) and pneumatic brake system of UIC type (as described in clause 4.2.4.3),
 - Lateral location of brake pipes and cocks according to the specification referenced in Appendix J-1, index 5,
 - A free space of 395 mm above the centre line of the hook to allow the fitting of the rescue adaptor as described below.
 - b) On 1520 mm system:
 - A centre buffer coupler geometrically and functionally compatible with a “SA3 coupling”; the height above rail of its coupling centre line being between 980 to 1080 mm (for all wheel and load conditions).

This is achieved either by means of a permanently installed compatible coupling system or through a rescue coupler (also called rescue adaptor). In the latter case, the unit assessed against this

UTP

TSI

shall be designed so that it is possible to carry the rescue coupler on-board.

- (4) The rescue coupler (as defined in clause 5.3.3) shall comply with the following requirements:
 - To be designed to allow the rescue at a speed of at least 30 km/h;
 - To be secured after mounting onto the recovery unit in a way that prevents it coming off during the rescue operation;
 - To withstand the forces due to the intended rescuing conditions;
 - To be designed such that it does not require any human presence between the recovery unit and the unit to be rescued whilst either one is moving;
 - Neither the rescue coupler nor any braking hose shall limit the lateral movement of the hook when fitted onto the recovery unit.

 OTIF	Uniform Technical Prescription (UTP)		UTP LOC&PAS	
	LOCOMOTIVES AND PASSENGER ROLLING STOCK		Page 39 of 272	
Status: DRAFT	Version: 03	TECH-20041 Annex	Original: EN	Date: 20.10.2020

(5) The brake requirement for rescue purpose is covered by the clause 4.2.4.10 of this

UTP.

~~TSI~~

4.2.2.2.5 Staff access for coupling and uncoupling

- (1) Units and end coupling-systems shall be designed so that staff is not exposed to undue risk during coupling and uncoupling, or rescue operations.
- (2) To comply with this requirement, units fitted with manual coupling systems of UIC type as per clause 4.2.2.2.3 b) shall comply with the following requirements (the ‘Bern rectangle’):
 - On units equipped with screw couplers and side buffers, the space for staff operation shall be in accordance to the specification referenced in Appendix J-1, index 6.
 - Where a combined automatic and screw coupler is fitted it is permissible for the auto coupler head to infringe the Berne rectangle on the left hand side when it is stowed and the screw coupler is in use.
 - There shall be a handrail under each buffer. The handrails shall withstand a force of 1.5 kN.
- (3) The operating and rescue documentation specified in clauses 4.2.12.4 and 4.2.12.6 shall describe measures that are necessary to meet this requirement. Member States may also require application of those requirements.

4.2.2.3 Gangways

- (1) Where a gangway is provided as a means for passengers to circulate from one coach or one trainset to another, it shall accommodate all relative movements of vehicles in normal operation without exposing passengers to undue risk.
- (2) Where operation with the gangway not being connected is foreseen, it shall be possible to prevent access by passengers to the gangway.
- (3) Requirements related to the gangway door when the gangway is not in use are specified in clause 4.2.5.7 “Passenger related items – Inter-unit doors”.
- (4) Additional requirements are expressed in

the UTP PRM.

~~the PRM TSI~~
- (5) These requirements of this clause do not apply to the end of vehicles where this area is not intended for regular use by passengers.

4.2.2.4 Strength of vehicle structure

- (1) This clause applies to all units except OTMs.
- (2) For OTMs, alternative requirements to those expressed in this clause for static load, category and acceleration are set out in Appendix C, clause C.1.
- (3) The static and dynamic strength (fatigue) of vehicle bodies is relevant to ensure the safety required for the occupants and the structural integrity of the vehicles in train and in shunting operations. Therefore,

 OTIF	Uniform Technical Prescription (UTP)		UTP LOC&PAS	
	LOCOMOTIVES AND PASSENGER ROLLING STOCK		Page 40 of 272	
Status: DRAFT	Version: 03	TECH-20041 Annex	Original: EN	Date: 20.10.2020

the structure of each vehicle shall comply with the requirements of the specification referenced in Appendix J-1, index 7. The rolling stock categories to be taken into account shall correspond to category L for locomotives and power head units and categories PI or PII for all other types of vehicle within the scope of this

UTP, ~~TSI~~

as defined in the specification referenced in Appendix J-1, index 7, clause 5.2.

- (4) Proof of the strength of the vehicle body may be demonstrated by calculations and/or by testing, according to the conditions set up in the specification referenced in Appendix J-1, index 7, clause 9.2.
- (5) In case of a unit designed for higher compressive force than those of the categories (required above as a minimum) in the specification referenced in Appendix J-1, index 7, this specification does not cover the proposed technical solution; it is then permissible to use for compressive force other normative documents that are publicly available.

In that case it shall be verified by the

assessing entity ~~notified body~~

that the alternative normative documents form part of a technically consistent set of rules applicable to the design, construction and testing of the vehicle structure.

The value of compressive force shall be recorded in the technical documentation defined in clause 4.2.12.

- (6) The load conditions considered shall be consistent with those defined in clause 4.2.2.10 of this

UTP. ~~TSI~~

- (7) The assumptions for aerodynamic loading shall be those described in clause 4.2.6.2.2 of this

UTP ~~TSI~~

(passing of 2 trains).

- (8) Joining techniques are covered by the above requirements. A verification procedure shall exist to ensure at the production phase that defects that may decrease the mechanical characteristics of the structure are controlled.

4.2.2.5 Passive safety

- (1) The requirements specified in this clause apply to all units, except to units not intended to carry passengers or staff during operation and except to OTMs.
- (2) For units designed to be operated on the 1520 mm system, the requirements on passive safety described in this clause are of voluntary application. If the Applicant chooses to apply the requirements on passive safety described in this clause, this shall be recognised by Member States. Member States may also require application of those requirements.
- (3) For locomotives designed to be operated on the 1524 mm system, the requirements on passive safety described in this clause are of voluntary application. If the Applicant chooses to apply the requirements on passive safety described in this clause, this shall be recognised by Member States.

 OTIF	Uniform Technical Prescription (UTP)		UTP LOC&PAS	
	LOCOMOTIVES AND PASSENGER ROLLING STOCK		Page 41 of 272	
Status: DRAFT	Version: 03	TECH-20041 Annex	Original: EN	Date: 20.10.2020

- (4) Units which cannot operate up to the collision speeds specified under any of the collision scenarios below are exempted from the provisions related to that collision scenario.
- (5) Passive safety is aimed at complementing active safety when all other measures have failed. For this purpose, the mechanical structure of vehicles shall provide protection of the occupants in the event of a collision by providing means of:
- limiting deceleration
 - maintaining survival space and structural integrity of the occupied areas
 - reducing the risk of overriding
 - reducing the risk of derailment
 - limiting the consequences of hitting a track obstruction.

To meet these functional requirements, units shall comply with the detailed requirements specified in the specification referenced in Appendix J-1, index 8 related to crashworthiness design category C-I (as per the specification referenced in Appendix J-1, index 8, Table 1 section 4), unless specified otherwise below.

The following four reference collision scenarios shall be considered:

- scenario 1: A front end impact between two identical units;
- scenario 2: A front end impact with a freight wagon;
- scenario 3: An impact of the unit with a large road vehicle on a level crossing;
- scenario 4: An impact of the unit into a low obstacle (e.g. car on a level crossing, animal, rock etc.).

~~(6) Within the scope of the present~~

~~UTP,~~

~~TSI,~~

~~‘Table 2 application rules’ in the specification referenced in point (5) above are completed by the following: the application of requirements related to scenarios 1 and 2 to locomotives:~~

- ~~• fitted with automatic end centre buffer couplers,~~
- ~~• and capable of a traction effort higher than 300 kN~~

~~is an open point.~~

~~Note: such high traction effort is required for heavy haul freight locomotives.~~

~~(7) Due to their specific architecture, it is permitted for locomotives with single “central cab” as an alternative method to demonstrate compliance against the requirement of scenario 3 by demonstrating compliance with following criteria:~~

- ~~• the frame of the locomotive is designed according to the specification referenced in Appendix J-1, index 8 cat L (as already specified in clause 4.2.2.4 of this~~

~~UTP).~~

~~TSI).~~

- ~~• the distance between buffers and windscreen cab is at least 2,5 m.~~

 OTIF	Uniform Technical Prescription (UTP)		UTP LOC&PAS	
	LOCOMOTIVES AND PASSENGER ROLLING STOCK		Page 42 of 272	
Status: DRAFT	Version: 03	TECH-20041 Annex	Original: EN	Date: 20.10.2020

(6) [These scenarios are described in the specification referenced in Appendix J-1, index 8, Table 2 of section -5.](#)

(7) [Within the scope of T](#)he present

(8)

UTP,

TSI,

~~specifies crashworthiness requirements applicable within its scope; therefore, the Annex A of the specification referenced in Appendix J-1, index 8 shall not apply. The requirements of the specification referenced in Appendix J-1, index 8 section 6 shall be applied in relation to the above given reference collision scenarios.~~ [the “collision speed” and “collision partner” when scenarios 1 and 2 are applied to locomotives fitted with automatic end centre buffer couplers and capable of a traction effort at coupling higher than 300 kN described in Table 2 of the specification referenced in appendix J-1, index 8 shall be:](#)

- [20 km/h instead of 36 km/h for scenarios 1 and 2; and](#)
- [the reference wagon described in appendix D instead of reference wagon described in annex C.1 of the specification referenced in appendix J-1, index 8 for scenario 2.](#)

[Note: such high traction effort is required for heavy haul freight locomotives.](#)

(8) To limit the consequences of hitting a track obstruction, the leading ends of locomotives, power heads, driving coaches and trainsets shall be equipped with an obstacle deflector. The requirements with which obstacle deflectors shall comply are defined in the specification referenced in Appendix J-1, index 8, ~~table 3 of section 5 and~~ section 6.5.

4.2.2.6 Lifting and jacking

- (1) This clause applies to all units.
- (2) Additional provisions concerning the lifting and jacking of OTMs are specified in Appendix C, clause C.2.
- (3) It shall be possible to safely lift or jack each vehicle composing the unit, for recovery purposes (following derailment or other accident or incident), and for maintenance purposes. To this purpose, suitable vehicle body interfaces (lifting/jacking points) shall be provided, which permit the application of vertical or quasi-vertical forces. The vehicle shall be designed for complete lifting or jacking, including the running gear (e.g. by securing/attaching the bogies to the vehicle body). It shall also be possible to lift or jack any end of the vehicle (including its running gear) with the other end resting on the remaining running gear(s).
- (4) It is recommended to design jacking points so that they can be used as lifting points with all the running gears of the vehicle linked to the underframe of the vehicle.
- (5) Jacking/Lifting points shall be located such as to enable the safe and stable lifting of the vehicle; sufficient space shall be provided underneath and around each jacking point to allow an easy installation of rescue devices. Jacking/Lifting points shall be designed such that staff is not exposed to any undue risk under normal operation or when using the rescue equipments.
- (6) When the lower structure of the bodyshell does not allow the provision of permanent built-in jacking/lifting points, this structure shall be provided with fixtures which permit the fixation of removable jacking/lifting points during the re-railing operation.

 OTIF	Uniform Technical Prescription (UTP)		UTP LOC&PAS	
	LOCOMOTIVES AND PASSENGER ROLLING STOCK		Page 43 of 272	
Status: DRAFT	Version: 03	TECH-20041 Annex	Original: EN	Date: 20.10.2020

- (7) The geometry of permanent built-in jacking/lifting points shall be compliant with the specification referenced in Appendix J-1, index 9, clause 5.3; the geometry of removable jacking/lifting points shall be compliant with the specification referenced in Appendix J-1, index 9, clause 5.4.
- (8) Marking of lifting points shall be made by signs compliant with the specification referenced in Appendix J-1, index 10.
- (9) The structure shall be designed with consideration of the loads specified in the specification referenced in Appendix J-1, index 11, clauses 6.3.2 and 6.3.3; proof of the strength of the vehicle body may be demonstrated by calculations or by testing, according to the conditions set up in the specification referenced in Appendix J-1, index 11, clause 9.2.

Alternative normative documents may be used under the same conditions as defined in clause 4.2.2.4 above.

UTP.	TSI
------	----------------

Instructions shall be given as far as feasible by pictograms.

- (10) For each vehicle of the unit, a jacking and lifting diagram and corresponding instructions shall be provided in the documentation as described in clauses 4.2.12.5 and 4.2.12.6 of this

UTP.	TSI
------	----------------

Instructions shall be given as far as feasible by pictograms.

4.2.2.7 Fixing of devices to carbody structure

- (1) This clause applies to all units, except to OTMs.
- (2) Provisions concerning the structural strength of OTMs are specified in Appendix C, clause C.1.
- (3) Fixed devices including those inside the passenger areas, shall be attached to the car body structure in a way that prevents these fixed devices becoming loose and presenting a risk of passenger injuries or lead to a derailment. To this aim, attachments of these devices shall be designed according to the specification referenced in Appendix J-1, index 12, considering category L for locomotives and category P-I or P-II for passenger rolling stock.
- (4) Alternative normative documents may be used under the same conditions as defined in clause 4.2.2.4 above.

4.2.2.8 Staff and freight access doors

- (1) The doors for use of passengers are covered by the clause 4.2.5 of this

UTP:	TSI
------	----------------

“Passenger related items”. Cab doors are addressed in clause 4.2.9 of this

UTP.	TSI
------	----------------

This clause addresses doors for freight use and for use of train crew other than cab doors.

 OTIF	Uniform Technical Prescription (UTP)		UTP LOC&PAS	
	LOCOMOTIVES AND PASSENGER ROLLING STOCK		Page 44 of 272	
Status: DRAFT	Version: 03	TECH-20041 Annex	Original: EN	Date: 20.10.2020

- (2) Vehicles fitted with a compartment dedicated to train crew or freight shall be equipped with a device to close and lock the doors. The doors shall remain closed and locked until they are intentionally released.

4.2.2.9 Mechanical characteristics of glass (other than windscreens)

- (1) Where glass is used in glazing (including mirrors), it shall be either laminated or toughened glass which is in accordance with one of the relevant publicly available standards suitable for railway application with regard to the quality and area of use, thereby minimising the risk to passenger and staff being injured by breaking glass.

4.2.2.10 Load conditions and weighed mass

- (1) The following load conditions defined in the specification referenced in Appendix J-1, index 13, clause ~~2.14.5~~ shall be determined:

- Design mass under exceptional payload
- Design mass under normal payload
- Design mass in working order

- (2) The hypothesis taken for arriving at the load conditions above shall be justified and documented in the general documentation described in clause 4.2.12.2 of this

UTP.

~~TSI~~

These hypothesis shall be based on a rolling stock categorisation (high speed and long distance train, other) and on a payload description (passengers, payload per m² in standing and service areas) consistent with the specification referenced in Appendix J-1, index 13; values for the different parameters may deviate from this standard provided that they are justified.

- (3) For OTMs, different load conditions (minimum mass, maximum mass) may be used, in order to take into account optional on-board equipment.

- (4) The conformity assessment procedure is described in clause 6.2.3.1 of this

UTP.

~~TSI~~

- 5 For each load condition defined above, the following information shall be provided in the technical documentation described in clause 4.2.12:

- Total vehicle mass (for each vehicle of the unit)
- Mass per axle (for each axle)
- Mass per wheel (for each wheel).

Note: for units equipped with independently rotating wheels, “axle” shall be interpreted as a geometric notion, and not as a physical component; this is valid to the whole

UTP,

~~TSI~~

unless stated otherwise.

 OTIF	Uniform Technical Prescription (UTP)		UTP LOC&PAS	
	LOCOMOTIVES AND PASSENGER ROLLING STOCK		Page 45 of 272	
Status: DRAFT	Version: 03	TECH-20041 Annex	Original: EN	Date: 20.10.2020

4.2.3 Track interaction and gauging

4.2.3.1 Gauging

- (1) This clause concerns the rules for calculation and verification intended for sizing the rolling stock to run on one or several infrastructures without interference risk.

For units designed to be operated on other track gauge(s) than 1520 mm system:

- (2) The applicant shall select the intended reference profile including the reference profile for the lower parts. This reference profile shall be recorded in the technical documentation defined in clause 4.2.12 of this

UTP.

~~TSI~~

- (3) The compliance of a unit with this intended reference profile shall be established by one of the methods set out in the specification referenced in Appendix J-1, index 14.

During a transitional period ending

on 31.12.2017,

3 years after the date of application of this TSI,

for technical compatibility with the existing national network it is permissible for the reference profile of the unit to alternatively be established in accordance with the national technical rules notified for this purpose.

This shall not prevent the access of

UTP

~~TSI~~

compliant rolling stock to the national network.

- (4) In case the unit is declared as compliant with one or several of the reference contours G1, GA, GB, GC or DE3, including those related to the lower part GI1, GI2 or GI3, as set out in the specification referenced in Appendix J-1, index 14, compliance shall be established by the kinematic method as set out in the specification referenced in Appendix J-1, index 14.

The compliance to those reference contour(s) shall be recorded in the technical documentation defined in clause 4.2.12 of this

UTP.

~~TSI~~

- (5) For electric units, the pantograph gauge shall be verified by calculation according to the specification referenced in Appendix J-1, index 14, clause A.3.12 to ensure that the pantograph envelope complies with the mechanical kinematic pantograph gauge

of the networks on which the vehicle is intended to be operated and to be defined by the applicant.

which in itself is determined according to Appendix D of ENE TSI,

and depends on the choice made for the pantograph head geometry: the two permitted possibilities are defined in clause 4.2.8.2.9.2 of this

UTP.

~~TSI~~

 OTIF	Uniform Technical Prescription (UTP)		UTP LOC&PAS	
	LOCOMOTIVES AND PASSENGER ROLLING STOCK		Page 46 of 272	
Status: DRAFT	Version: 03	TECH-20041 Annex	Original: EN	Date: 20.10.2020

The voltage of the power supply is considered in the infrastructure gauge in order to ensure the proper insulation distances between the pantograph and fixed installations.

(6) The pantograph sway

as

as specified in clause 4.2.10 of ENE TSI and

used for the mechanical kinematic gauge calculation shall be justified by calculations or measurements as set out in the specification referenced in Appendix J-1, index 14.

For units designed to be operated on track gauge of 1520 mm system:

(7) The static contour of the vehicle shall be within the ‘T’ uniform vehicle gauge; the reference contour for infrastructure is the ‘S’ gauge. This contour is specified in Appendix B.

(8) For electric units the pantograph gauge shall be verified by calculation to ensure that the pantograph envelope complies with the mechanical static pantograph gauge

of the networks on which the vehicle is intended to be operated and to be defined by the applicant; which is defined in Appendix D of ENE TSI;

the choice made for the pantograph head geometry shall be taken into account: the permitted possibilities are defined in clause 4.2.8.2.9.2 of this

UTP.

~~TSI.~~

4.2.3.2 Axle load and wheel load

4.2.3.2.1 Axle load parameter

(1) The axle load is an interface parameter between the unit and the infrastructure. The axle load is a performance parameter of the infrastructure

which should be specified by the Competent Authority of the relevant Contracting States in such a way that the information is available to railway undertakings operating on their international lines. specified in clause 4.2.1 of the INF TSI and depends on the traffic code of the line.

It has to be considered in combination with the axle spacing, with the train length and with the maximum allowed speed for the unit on the considered line.

(2) The following characteristics to be used as an interface to the infrastructure shall be part of the general documentation produced when the unit is assessed, and described in clause 4.2.12.2 of this

UTP:

~~TSI.~~

- The mass per axle (for each axle) for the three load conditions (as defined and required to be part of the documentation in clause 4.2.2.10 of this

UTP).

~~TSI.~~

- The position of the axles along the unit (axle spacing).

 OTIF	Uniform Technical Prescription (UTP)		UTP LOC&PAS	
	LOCOMOTIVES AND PASSENGER ROLLING STOCK		Page 47 of 272	
Status: DRAFT	Version: 03	TECH-20041 Annex	Original: EN	Date: 20.10.2020

- The length of the unit.
- The maximum design speed (as required to be part of the documentation in clause 4.2.8.1.2 of this

UTP).

~~TSI~~.

- (3) Use of this information at operational level for compatibility check between rolling stock and infrastructure (outside the scope of this

UTP):

~~TSI~~.

The axle load of each individual axle of the unit to be used as interface parameter to the infrastructure has to be defined by the railway undertaking

in the light of its responsibility to operate vehicles only on infrastructure compatible with the vehicle,

as required in clause 4.2.2.5 of the OPE TSI,

considering the expected load for the intended service (not defined when the unit is assessed). The axle load in load condition “design mass under exceptional payload” represents the maximum possible value of the axle load mentioned above. The maximum load considered for the design of the brake system defined in clause 4.2.4.5.2 has also to be considered.

4.2.3.2.2 Wheel load

- (1) The ratio of wheel load difference per axle $\Delta_{qj} = (Q_l - Q_r)/(Q_l + Q_r)$, shall be evaluated by wheel load measurement, considering the load condition “design mass in working order”. Wheel load difference higher than 5% of the axle load for that wheelset are allowed only if demonstrated as acceptable by the test to prove safety against derailment on twisted track specified in the clause 4.2.3.4.1 of this

UTP.

~~TSI~~.

- (2) The conformity assessment procedure is described in clause 6.2.3.2 of this

UTP.

~~TSI~~.

- (3) For units with axle load in design mass under normal payload lower or equal to 22.5 tons and a worn wheel diameter higher than or equal to 470 mm, the wheel load over the wheel diameter (Q/D) shall be lower or equal to 0.15 kN/mm, as measured for a minimum worn wheel diameter and design mass under normal payload.

4.2.3.3 Rolling Stock parameters which influence ground based systems

4.2.3.3.1 Rolling Stock characteristics for the compatibility with train detection systems

- (1) For units designed to be operated on other track gauges than the 1520 mm system, the set of rolling stock characteristics for compatibility with train detection target systems are given in clauses 4.2.3.3.1.1, 4.2.3.3.1.2 and 4.2.3.3.1.3.

Reference is made to clauses of the specification referenced in Appendix J-2, index 1 of this

UTP.

TSI. (also referenced in Annex A, Index 77 of CCS TSI).

 OTIF	Uniform Technical Prescription (UTP)		UTP LOC&PAS	
	LOCOMOTIVES AND PASSENGER ROLLING STOCK		Page 48 of 272	
Status: DRAFT	Version: 03	TECH-20041 Annex	Original: EN	Date: 20.10.2020

- (2) The set of characteristics the rolling stock is compatible with shall be recorded in the technical documentation described in clause 4.2.12 of this

UTP.

~~TSI~~

4.2.3.3.1.1 Rolling stock characteristics for compatibility with train detection system based on track circuits

Vehicle geometry

- (1) The maximum distance between 2 consecutive axles is specified in the specification referenced in Appendix J-2, index 1, clause 3.1.2.1. (distance a1 in Figure 1).
- (2) The maximum distance between buffer end and first axle is specified in the specification referenced in Appendix J-2, index 1, clauses 3.1.2.5. & 6. (distance b1 in Figure 1).
- (3) The minimum distance between end axles of a unit is specified in the specification referenced in Appendix J-2, index 1, clause 3.1.2.4.

Vehicle design

- (4) The minimum axle load in all load conditions is specified in the specification referenced in Appendix J-2, index 1, clause 3.1.7.
- (5) The electrical resistance between the running surfaces of the opposite wheels of a wheelset is specified in the specification referenced in Appendix J-2, index 1, clause 3.1.9 and the method to measure is specified in the same clause.
- (6) For electric units equipped with a pantograph, the minimum impedance between pantograph and each wheel of the train is specified in the specification referenced in Appendix J-2, index 1, clause 3.2.2.1.

Isolating emissions

- (7) The limitations of use of sanding equipment are given in the specification referenced in Appendix J-2, index 1, clause 3.1.4; “sand characteristics” is part of in this specification.
- ~~(8)~~ In case where an automatic sanding function is provided, it shall be possible for the driver to suspend its use on particular points of the track identified in operating rules as non-compatible with sanding.
- ~~(8)~~ The limitations of use of composite brake blocks are given in the specification referenced in Appendix J-2, index 1, clause 3.1.6.

EMC

- ~~(9)~~ The requirements related to electromagnetic compatibility are specified in the specification referenced in Appendix J-2, index 1, clauses 3.2.1. and 3.2.2.
- ~~(10)~~ The electromagnetic interference limit levels rising from traction currents are specified in the specification referenced in Appendix J-2, index 1, clause 3.2.2.

4.2.3.3.1.2 Rolling stock characteristics for compatibility with train detection system based on axle counters

Vehicle geometry

 OTIF	Uniform Technical Prescription (UTP)		UTP LOC&PAS	
	LOCOMOTIVES AND PASSENGER ROLLING STOCK		Page 49 of 272	
Status: DRAFT	Version: 03	TECH-20041 Annex	Original: EN	Date: 20.10.2020

- (1) The maximum distance between 2 consecutive axles is specified in the specification referenced in Appendix J-2, index 1, clause 3.1.2.1.
- (2) The minimum distance between 2 consecutive axles of the train is specified in the specification referenced in Appendix J-2, index 1, clause 3.1.2.2.
- (3) At the end of a unit intended to be coupled, the minimum distance between end and first axle of the unit is half of the value specified in the specification referenced in Appendix J-2, index 1, clause 3.1.2.2.
- (4) The maximum distance between end and first axle is specified in the specification referenced in Appendix J-2, index 1, clause 3.1.2.5 & 6 (distance b1 in Figure 1).

Wheel geometry

- (5) Wheel geometry is specified in the clause 4.2.3.5.2.2 of the present

UTP.	TSI
------	----------------
- (6) The minimum wheel diameter (speed dependant) is specified in the specification referenced in Appendix J-2, index 1, clause 3.1.3

Vehicle design

- (7) The metal-free space around wheels is specified in the specification referenced in Appendix J-2, index 1, clause 3.1.3.5.
- (8) The characteristics of the wheel material regarding magnetic field is specified in the specification referenced in Appendix J-2, index 1, clause 3.1.3.6.

EMC

- (9) The requirements related to electromagnetic compatibility are specified in specification referenced in Appendix J-2, index 1, clauses 3.2.1.and 3.2.2.
- (10) The electromagnetic interference limit levels rising from the use of eddy current or magnetic track brakes are specified in the specification referenced in Appendix J-2, index 1, clause 3.2.3.

4.2.3.3.1.3 Rolling stock characteristics for compatibility with loop equipment

Vehicle design

- (1) The vehicle metal construction is specified in the specification referenced in Appendix J-2, index 1, clause 3.1.7.2.

4.2.3.3.2 Axle bearing condition monitoring

- (1) Axle bearing condition monitoring objective is to detect deficient axle box bearings.
- (2) For units of maximum design speed higher than or equal to 250 km/h, on board detection equipment shall be provided.

 OTIF	Uniform Technical Prescription (UTP)		UTP LOC&PAS	
	LOCOMOTIVES AND PASSENGER ROLLING STOCK		Page 50 of 272	
Status: DRAFT	Version: 03	TECH-20041 Annex	Original: EN	Date: 20.10.2020

- (3) For units of maximum design speed lower than 250 km/h, and designed to be operated on others track gauge systems than the 1520 mm system, axle bearing condition monitoring shall be provided and be achieved either by on board equipment (according to specification in clause 4.2.3.3.2.1) or by using track side equipment (according to specification in clause 4.2.3.3.2.2).
- (4) The fitment of on board system or/and the compatibility with track side equipment shall be recorded in the technical documentation described in clause 4.2.12 of this

UTP.

~~TSI.~~

4.2.3.3.2.1 Requirements applicable to on board detection equipment

- (1) This equipment shall be able to detect a deterioration of any of the axle box bearings of the unit.
- (2) The bearing condition shall be evaluated either by monitoring its temperature, or its dynamic frequencies or some other suitable bearing condition characteristic.
- (3) The detection system shall be located entirely on board the unit, and diagnosis messages shall be made available on board.
- (4) The diagnosis messages delivered shall be described, and shall be taken into account in the operating documentation described in clause 4.2.12.4 of this

UTP,

~~TSI.~~

and in the maintenance documentation described in clause 4.2.12.3 of this

UTP.

~~TSI.~~

4.2.3.3.2.2 Rolling stock requirements for compatibility with trackside equipment

- (1) For units designed to be operated on the 1435 mm system, the zone visible to the trackside equipment on rolling stock shall be the area as defined in the specification referenced in Appendix J-1, index 15.
- (2) For units designed to be operated on other track gauges [than 1435 mm or 1668 mm](#) a specific case is declared where relevant (harmonised rule available for the concerned network).

(2a) [For units designed to be operated on the 1668 mm system, the zone visible to the trackside equipment on rolling stock shall be the area as defined in the following table referring to the parameters of the specification referenced in Appendix J-1, index 15.](#)

Target and prohibitive zone for units intended to be operated on 1668 mm networks:

Track gauge [mm]	YTA [mm]	WTA [mm]	LTA [mm]	YPZ [mm]	WPZ [mm]	LPZ [mm]
1668	1176 ± 10	≥ 55	≥ 100	1176 ± 10	≥ 110	≥ 500

 OTIF	Uniform Technical Prescription (UTP)		UTP LOC&PAS	
	LOCOMOTIVES AND PASSENGER ROLLING STOCK		Page 51 of 272	
Status: DRAFT	Version: 03	TECH-20041 Annex	Original: EN	Date: 20.10.2020

4.2.3.4 Rolling stock dynamic behaviour

4.2.3.4.1 Safety against derailment running on twisted track

(1) The unit shall be designed to ensure safe running on twisted track, taking into account specifically the transition phase between canted and level track and cross level deviations.

(2) The conformity assessment procedure is described in clause 6.2.3.3 of this

UTP.

~~TSI.~~

This conformity assessment procedure is applicable for axle loads

in the range of those mentioned in the clause 4.2.1 of the UTP INF ~~from 12 to 25 tons~~

~~in the range of those mentioned in the clause 4.2.1 of the INF TSI~~

and in the specification referenced in Annex J-1, index 16.

It is not applicable to vehicle designed for higher axle load, such cases may be covered by national rules or by the procedure for innovative solution described

in this UTP.

in article 10 and Chapter 6 of this TSI.

4.2.3.4.2 Running dynamic behaviour

(1) This clause is applicable to units designed for a speed higher than 60 km/h, except to on-track machines for which the requirements are set out in Appendix C, clause C.3 and except units designed to be operated on the 1520 mm track gauge for which the corresponding requirements are considered as “open point”.

(2) The dynamic behaviour of a vehicle has a strong influence on running safety and track loading. It is an essential function for safety, covered by the requirements of this clause.

a) Technical requirements

(3) The unit shall run safely and produce an acceptable level of track loading when operated within the limits defined by the combination(s) of speed and cant deficiency under the ~~reference~~ conditions set out in the ~~technical documents~~ specification referenced in Appendix J-~~21~~, index ~~216~~.

This shall be assessed by verifying that limit values specified below in clauses 4.2.3.4.2.1 and 4.2.3.4.2.2 of this

UTP

~~TSI~~

are respected; the conformity assessment procedure is described in clause 6.2.3.4 of this

UTP.

~~TSI.~~

(4) The limit values and conformity assessment mentioned in point (3) are applicable for axle loads in the range of those mentioned in the clause 4.2.1 of the UTP INF

~~applicable on the international lines on which the vehicle is intended to be operated~~

~~in the range of those mentioned in the clause 4.2.1 of the INF TSI~~

and in the specification referenced in Annex J-1, index 16.

 OTIF	Uniform Technical Prescription (UTP)		UTP LOC&PAS	
	LOCOMOTIVES AND PASSENGER ROLLING STOCK		Page 52 of 272	
Status: DRAFT	Version: 03	TECH-20041 Annex	Original: EN	Date: 20.10.2020

They are not applicable to vehicles designed for higher axle load, as harmonised track loading limit values are not defined; such cases may be covered by national rules or by the procedure for innovative solution described in

this UTP. It shall be the task of the Competent Authority of each Contracting State to make available to the applicant the maximum axle load characteristics of the international lines. | article 10 and Chapter 6 of this TSI.

- (5) The running dynamic behaviour test report (including limits of use and track loading parameters) shall be stated in the technical documentation described in clause 4.2.12 of this

UTP. | ~~TSI~~

Track loading parameters (including the additional ones Y_{max} , B_{max} and the B_{qst} where relevant) to be recorded are defined in the specification referenced in Appendix J-1, index 16 ~~with the modifications as set out in the technical document referenced in Appendix J-2, index 2.~~

b) Additional requirements when an active system is used

- (6) When active systems (based on software or programmable controller controlling actuators) are used, the functional failure has typical credible potential to lead directly to “fatalities” for both of the following scenarios:

1. failure in the active system leading to a non-compliance with limit values for running safety (defined in accordance with clauses 4.2.3.4.2.1 and 4.2.3.4.2.2).
2. failure in the active system leading to a vehicle outside of the kinematic reference contour of the carbody and pantograph, due to tilting angle (sway) leading to non-compliance with the values assumed as set out in clause 4.2.3.1.

Considering this severity of the failure consequence it shall be demonstrated that the risk is controlled to an acceptable level.

The demonstration of compliance (conformity assessment procedure) is described in clause 6.2.3.5 of this

UTP. | ~~TSI~~

c) Additional requirements when an instability detection system is installed (option)

- (7) The instability detection system shall provide information regarding the need to take operative measures (such as reduction of speed etc.), and it shall be described in the technical documentation. The operative measures shall be described in the operating documentation set out in clause 4.2.12.4 of this

UTP. | ~~TSI~~

4.2.3.4.2.1 Limit values for running safety

- (1) The limit values for running safety which the unit shall meet are specified in the specification referenced in Appendix J-1, index 17, ~~and additionally for trains intended to be operated with a cant deficiencies > 165 mm in the specification referenced in Appendix J-1, index 18, with the modifications as set out in the technical document referenced in Appendix J-2, index 2.~~

 OTIF	Uniform Technical Prescription (UTP)		UTP LOC&PAS	
	LOCOMOTIVES AND PASSENGER ROLLING STOCK		Page 53 of 272	
Status: DRAFT	Version: 03	TECH-20041 Annex	Original: EN	Date: 20.10.2020

4.2.3.4.2.2 Track loading limit values

- (1) The limit values for track loading which the unit shall meet (when assessing with the normal method) are specified in the specification referenced in Appendix J-1, index 19 ~~with the modifications as set out in the technical document referenced in Appendix J-2, index 2.~~
- (2) In case the estimated values exceed the limit values expressed above, the operational conditions for the rolling stock (e.g. maximum speed, cant deficiency) may be adjusted taking into account track characteristics (e.g. curve radius, cross section of the rail, sleeper spacing, track maintenance intervals).

4.2.3.4.3 Equivalent conicity

4.2.3.4.3.1 Design values for new wheel profiles

- (1) The clause 4.2.3.4.3 is applicable to all units, except for unit designed to be operated on the 1520 mm or 1600 mm track gauge for which the corresponding requirements are an open point.
- (2) A new wheel profile and the distance between active faces of the wheels shall be checked in respect of target equivalent conicities using the calculation scenarios provided in clause 6.2.3.6 of this

UTP	TSI
in order to establish the suitability of the new proposed wheel profile for infrastructure on which the vehicle is designed to be operated.	in accordance with the INF TSI.
- (3) Units equipped with independently rotating wheels are exempt from these requirements.

4.2.3.4.3.2 In-service values of wheelset equivalent conicity

- (1) The combined equivalent conicities the vehicle is designed for, as verified by the demonstration of conformity of the running dynamic behaviour specified in clause 6.2.3.4 of this

UTP,	TSI,
------	-----------------

 shall be specified for in-service conditions in the maintenance documentation as set out in point 4.2.12.3.2, taking into account the contributions of wheel and rail profiles.
- (2) If ride instability is reported, the railway undertaking and the Infrastructure Manager shall localise the section of the line in a joint investigation.
- (3) The railway undertaking shall measure the wheel profiles and the front-to-front distance (distance of active faces) of the wheelsets in question. The equivalent conicity shall be calculated using the calculation scenarios provided in clause 6.2.3.6 in order to check if compliance with the maximum equivalent conicity the vehicle was designed and tested for is met. If it is not the case, the wheel profiles have to be corrected.
- (4) If the wheelset conicity complies with the maximum equivalent conicity the vehicle was designed and tested for, a joint investigation by the railway undertaking and the infrastructure manager shall be undertaken to determine the characteristics reason for the instability.
- (5) Units equipped with independently rotating wheels are exempt from these requirements.

 OTIF	Uniform Technical Prescription (UTP)		UTP LOC&PAS	
	LOCOMOTIVES AND PASSENGER ROLLING STOCK		Page 54 of 272	
Status: DRAFT	Version: 03	TECH-20041 Annex	Original: EN	Date: 20.10.2020

4.2.3.5 Running gear

4.2.3.5.1 Structural design of bogie frame

- (1) For units which include a bogie frame, the integrity of the structure of the bogie frame, axle box housing and all attached equipment shall be demonstrated based on methods as set out in the specification referenced in Appendix J-1, index 20.
- (2) The body to bogie connection shall comply with the requirements of the specification referenced in Appendix J-1, index 21.
- (3) The hypothesis taken to evaluate the loads due to bogie running (formulas and coefficients) in line with the specification referenced in Appendix J-1, index 20 shall be justified and documented in the technical documentation described in clause 4.2.12 of this

UTP.

~~TSI~~

4.2.3.5.2 Wheelsets

- (1) For the purpose of this

UTP,

~~TSI~~

wheelsets are defined to include main parts ensuring the mechanical interface with the track (wheels and connecting elements: e.g. transverse axle, independent wheel axle) and accessories parts (axle bearings, axle boxes, gearboxes and brake discs).

- (2) The wheelset shall be designed and manufactured with a consistent methodology using a set of load cases consistent with load conditions defined in clause 4.2.2.10 of this

UTP.

~~TSI~~

4.2.3.5.2.1 Mechanical and geometric characteristics of wheelsets

Mechanical behaviour of wheelsets

- (1) The mechanical characteristics of the wheelsets shall ensure the safe movement of rolling stock.

The mechanical characteristics cover:

- assembly
- mechanical resistance and fatigue characteristics

The conformity assessment procedure is described in clause 6.2.3.7 of this

UTP.

~~TSI~~

Mechanical behaviour of axles

- (2) The characteristics of the axle shall ensure the transmission of forces and torque.

The conformity assessment procedure is described in clause 6.2.3.7 of this

UTP.

~~TSI~~

 OTIF	Uniform Technical Prescription (UTP)		UTP LOC&PAS	
	LOCOMOTIVES AND PASSENGER ROLLING STOCK		Page 55 of 272	
Status: DRAFT	Version: 03	TECH-20041 Annex	Original: EN	Date: 20.10.2020

Case of units equipped with independently rotating wheels

- (3) The characteristics of the end of axle (interface between wheel and running gear) shall ensure the transmission of forces and torque.

The conformity assessment procedure shall be in accordance with point (7) of clause 6.2.3.7 of this

UTP.

~~TSI~~

Mechanical behaviour of the axle boxes

- (4) The axle box shall be designed with consideration of mechanical resistance and fatigue characteristics.

The conformity assessment procedure is described in clause 6.2.3.7 of this

UTP.

~~TSI~~

- (5) Temperature limits shall be defined by testing and recorded in the technical documentation described in clause 4.2.12 of this

UTP.

~~TSI~~

Axle bearing condition monitoring is defined in clause 4.2.3.3.2 of this

UTP.

~~TSI~~

Geometrical dimensions of wheelsets

- (6) The geometric dimensions of the wheelsets (as defined in Figure 1) shall be compliant with limit values specified in table 1 for the relevant track gauge.

These limit values shall be taken as design values (new wheelset) and as in-service limit values (to be used for maintenance purposes; see also clause 4.5 of this

UTP.

~~TSI~~

Table 1. In service limits of the geometric dimensions of wheelsets

Designation		Wheel diam. D [mm]	Minimum value[mm]	Maximum value [mm]
1435 mm	Front-to-front dimension (S_R) $S_R = A_R + S_{d, left} + S_{d, right}$	$330 \leq D \leq 760$	1415	1426
		$760 < D \leq 840$	1412	
		$D > 840$	1410	
	Back to back distance (A_R)	$330 \leq D \leq 760$	1359	1363
		$760 < D \leq 840$	1358	
		$D > 840$	1357	



1524 mm	Front-to-front dimension (S_R) $S_R = A_R + S_{d, \text{left}} + S_{d, \text{right}}$	$400 \leq D < 725$	1506	1509
		$D \geq 725$	1487	1514
	Back to back distance (A_R)	$400 \leq D < 725$	1444	1446
		$D \geq 725$	1442	1448
1520 mm	Front-to-front dimension (S_R) $S_R = A_R + S_{d, \text{left}} + S_{d, \text{right}}$	$400 \leq D \leq 1220$	1487	1509
	Back to back distance (A_R)	$400 \leq D \leq 1220$	1437	1443
1600 mm	Front-to-front dimension (S_R) $S_R = A_R + S_{d, \text{left}} + S_{d, \text{right}}$	$690 \leq D \leq 1016$	1573	1592
		Back to back distance (A_R)	$690 \leq D \leq 1016$	1521
1668 mm	Front-to-front dimension (S_R) $S_R = A_R + S_{d, \text{left}} + S_{d, \text{right}}$	$330 \leq D < 840$	1648	1659
		$840 \leq D \leq 1250$	1643	1659
	Back to back distance (A_R)	$330 \leq D < 840$	1592	1596
		$840 \leq D \leq 1250$	1590	1596

The dimension A_R is measured at the height of the top of rail. The dimensions A_R and S_R shall be complied with in laden and tare conditions. Smaller tolerances within the above limits may be specified by the manufacturer in the maintenance documentation for in-service values. The dimensions S_R is measured at 10 mm above tread datum (as shown in Figure 2).

 OTIF	Uniform Technical Prescription (UTP)		UTP LOC&PAS	
	LOCOMOTIVES AND PASSENGER ROLLING STOCK		Page 57 of 272	
Status: DRAFT	Version: 03	TECH-20041 Annex	Original: EN	Date: 20.10.2020

Figure 1. Symbols for wheelsets



4.2.3.5.2.2 Mechanical and geometrical characteristics of wheels

Mechanical behaviour of wheels

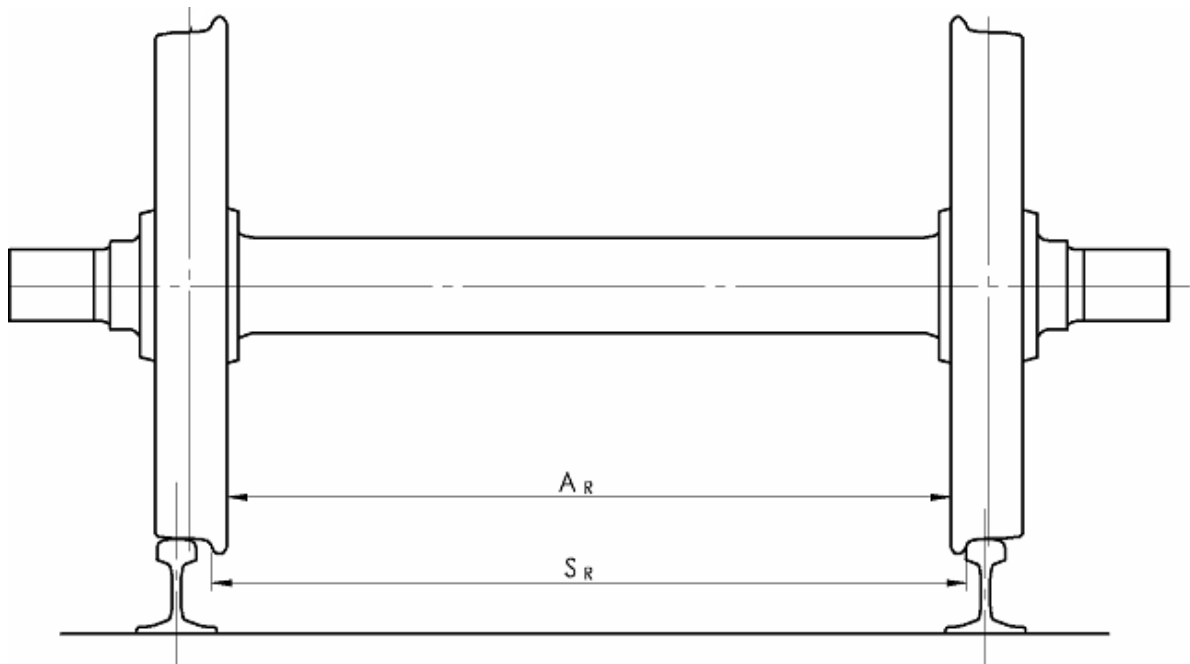
- (1) The characteristics of the wheels shall ensure the safe movement of rolling stock and contribute to the guidance of the rolling stock.

The conformity assessment procedure is described in clause 6.1.3.1 of this

UTP.

~~TSI~~

Geometrical dimensions of wheels

- (2) The geometrical dimensions of the wheels (as defined in Figure 2) shall be compliant with limit values specified in Table 2. These limit values shall be taken as design values (new wheel) and as in-service limit values (to be used for maintenance purposes; see also clause 4.5).



Table 2. In-service limits of the geometric dimensions of wheel

Designation	Wheel diameter D (mm)	Minimum value (mm)	Maximum value (mm)
Width of the rim (B_R+Burr)	$D \geq 330$	133	145
Thickness of the flange (S_d)	$D > 840$	22	33
	$760 < D \leq 840$	25	
	$330 \leq D \leq 760$	27,5	
Height of the flange (S_h)	$D > 760$	27,5	36
	$630 < D \leq 760$	29,5	
	$330 \leq D \leq 630$	31,5	
Face of flange (q_R)	$D \geq 330$	6.5	

Figure 2. Symbols for wheels

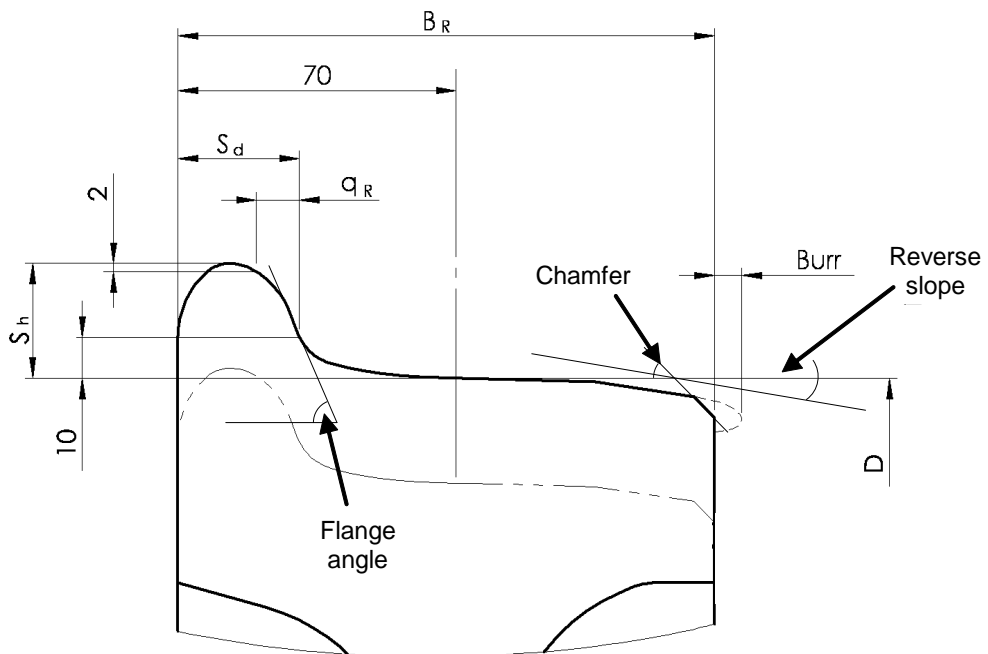

(3) Units equipped with independently rotating wheels shall, in addition to the requirements in this clause dealing with wheels, meet the requirements in this

 OTIF	Uniform Technical Prescription (UTP)		UTP LOC&PAS	
	LOCOMOTIVES AND PASSENGER ROLLING STOCK		Page 59 of 272	
Status: DRAFT	Version: 03	TECH-20041 Annex	Original: EN	Date: 20.10.2020

for geometrical characteristics of wheelsets defined in clause 4.2.3.5.2.1.

~~4.2.3.5.2.3 Variable gauge wheelsets~~

~~(1) This requirement is applicable to units equipped with variable gauge wheelsets with changeover between the track gauge 1435 mm and another track gauge in the scope of this~~

~~UTP:~~

~~TSI:~~

~~(1) The changeover mechanism of the wheelset shall ensure the safe locking in the correct intended axial position of the wheel.~~

~~(2) External visual verification of the state of the locking system (locked or unlocked) shall be possible.~~

~~(3) If the wheelset is equipped with brake equipment, the position and locking in the correct position of this equipment shall be ensured.~~

~~(4) The conformity assessment procedure of the requirements specified in this clause is an open point.~~

4.2.3.5.3 Automatic variable gauge systems

(1) This requirement is applicable to units equipped with an automatic variable gauge system with changeover mechanism of the axial position of the wheels allowing the unit to be compatible with 1435 mm track gauge and other track gauge(s) within the scope of this UTP by means of passage through a track gauge changeover facility.

(2) The changeover mechanism shall ensure the locking in the correct intended axial position of the wheel.

(3) After passage through the track gauge changeover facility, the verification of the state of the locking system (locked or unlocked) and of the position of the wheels shall be performed by one or more of the following means: visual control, on-board control system or infrastructure/facility control system. In case of on-board control system, a continuous monitoring shall be possible.

(4) If a running gear is equipped with brake equipment subject to a change in position during the gauge change operation, the automatic variable gauge system shall ensure the position and safe locking in the correct position of this equipment simultaneously to those of the wheels.

(5) The failure of the locking of the position of the wheels and braking equipment (if relevant) during operation has typical credible potential to lead directly to a catastrophic accident (resulting in multiple fatalities); considering this severity of the failure consequence, it shall be demonstrated that the risk is controlled to an acceptable level.

(6) The automatic variable gauge system is defined as an IC (clause 5.3.4a). The conformity assessment procedure is specified in clause 6.1.3.1a (IC level), in clause 6.2.3.5 (safety requirement) and in clause 6.2.3.7a (subsystem level) of this UTP.

(7) The track gauges the unit is compatible with shall be recorded in the technical documentation. A description of the changeover operation in normal mode, including the type(s) of track gauge changeover facility(ies) the unit is compatible with, shall be part of the technical documentation (see also clause 4.2.12.4 (1) of this UTP).

 OTIF	Uniform Technical Prescription (UTP)		UTP LOC&PAS	
	LOCOMOTIVES AND PASSENGER ROLLING STOCK		Page 60 of 272	
Status: DRAFT	Version: 03	TECH-20041 Annex	Original: EN	Date: 20.10.2020

[\(8\) The requirements and conformity assessments required in other sections of this UTP apply independently for each wheel position corresponding to one track gauge, and have to be documented accordingly.](#)

4.2.3.6 Minimum curve radius

- (1) The minimum curve radius to be negotiated shall be 150 m for all units.

4.2.3.7 Life guards

- (1) This requirement applies to units fitted with a driving cab.
- (2) The wheels shall be protected against damages caused by minor items on the rails. This requirement can be met by life guards in front of the wheels of the leading axle.
- (3) The height of the lower end of the life guard above the plain rail shall be:
 - 30 mm minimum in all conditions
 - 130 mm maximum in all conditions
 taking into account in particular wheel wear and suspension compression.
- (4) If an obstacle deflector specified in clause 4.2.2.5 has its lower edge at less than 130 mm above the plain rail in all conditions, it fulfils the functional requirement of the life guards and therefore it is permissible not to fit life guards.
- (5) A life guard shall be designed to withstand a minimum longitudinal static force without permanent deformation of 20 kN. This requirement shall be verified by a calculation.
- (6) A life guard shall be designed so that, during plastic deformation, it does not foul the track or running gear and that contact with the wheel tread, if it occurs, does not pose a risk of derailment.

4.2.4 Braking

4.2.4.1 General

- (1) The purpose of the train braking system is to ensure that the train's speed can be reduced or maintained on a slope, or that the train can be stopped within the maximum allowable braking distance. Braking also ensures the immobilisation of a train.
- (2) The primary factors that influence the braking performance are the braking power (braking force production), the train mass, the train rolling resistance, the speed, the available adhesion.
- (3) Individual unit performance for units operated in various train formations is defined so that the overall braking performance of the train can be derived.
- (4) The braking performance is determined by deceleration profiles [deceleration = F (speed) and equivalent response time].

Stopping distance, brake weight percentage (also called "lambda" or "braked mass percentage"), braked mass may also be used, and can be derived (directly or via stopping distance) from deceleration profiles by a calculation.

The braking performance could vary with the mass of the train or vehicle.

 OTIF	Uniform Technical Prescription (UTP)		UTP LOC&PAS	
	LOCOMOTIVES AND PASSENGER ROLLING STOCK		Page 61 of 272	
Status: DRAFT	Version: 03	TECH-20041 Annex	Original: EN	Date: 20.10.2020

- (5) The minimum train braking performance required to operate a train on a line at an intended speed is dependent on the line characteristics (signalling system, maximum speed, gradients, line safety margin) and is a characteristic of the infrastructure.

The train or vehicle main data characterising the braking performance is defined in the clause 4.2.4.5 of this

UTP.

~~TSI~~

4.2.4.2 Main functional and safety requirements

4.2.4.2.1 *Functional requirements*

The following requirements apply to all units.

Units shall be equipped with:

- a main brake function used during operation for service and emergency braking.
- a parking brake function used when the train is parked, allowing the application of a brake force without any available energy on board for an unlimited period of time.

The main brake function of a train shall be:

- continuous: the brake application signal is transmitted from a central command to the whole train by a control line.
- automatic: an inadvertent disruption (loss of integrity, line de-energized...) of the control line leads to brake activation on all vehicles of the train.
- It is permitted to complement the main brake function by additional brake systems described in clause 4.2.4.7 (dynamic brake – braking system linked to traction system) and/or clause 4.2.4.8 (braking system independent of adhesion conditions).
- The dissipation of the braking energy shall be considered in the design of the braking system, and shall not cause any damage to the components of the braking system in normal operation conditions; this shall be verified by a calculation as specified in clause 4.2.4.5.4 of this

UTP.

~~TSI~~

The temperature reached around the brake components shall also be considered in the design of the rolling stock.

- The design of the brake system shall include means for monitoring and tests as specified in clause 4.2.4.9 of this

UTP.

~~TSI~~

The requirements below in this clause 4.2.4.2.1 apply at train level to units for which the operating formation(s) is (are) defined at design stage [i.e. unit assessed in fixed formation, unit assessed in predefined formation(s), locomotive operated alone].

 OTIF	Uniform Technical Prescription (UTP)		UTP LOC&PAS	
	LOCOMOTIVES AND PASSENGER ROLLING STOCK		Page 62 of 272	
Status: DRAFT	Version: 03	TECH-20041 Annex	Original: EN	Date: 20.10.2020

- The braking performance shall be consistent with safety requirements expressed in clause 4.2.4.2.2 in case of inadvertent disruption of the brake control line, and in the event of the braking energy supply being disrupted, the power supply failing or other energy source failure.
- In particular, there shall be sufficient braking energy available on board the train (stored energy), distributed along the train consistent with the design of the brake system, to ensure the application of the required brake forces.
- Successive applications and releases of the brake shall be considered in the design of the braking system (inexhaustibility).
- In case of unintentional train separation, the two parts of the train shall be brought to a standstill; the braking performances on the two parts of the train are not required to be identical to the braking performance in normal mode.
- In the event of the braking energy supply being disrupted or the power supply failing, it shall be possible to hold in a stationary position a unit with maximum braking load (as defined in clause 4.2.4.5.2) on a 40 ‰ gradient by using the friction brake of the main brake system alone, for at least two hours.
- The unit braking control system shall have three control modes:
 - emergency braking: application of a predefined brake force in a predefined maximum response time in order to stop the train with a defined level of brake performance.
 - service braking: application of an adjustable brake force in order to control the speed of the train, including stop and temporary immobilisation.
 - parking braking: application of a brake force to maintain the train (or the vehicle) in permanent immobilisation in a stationary position, without any available energy on board.
- A brake application command, whatever its control mode, shall take control of the brake system, even in case of active brake release command; this requirement is permitted not to apply when intentional suppression of the brake application command is given by the driver (e.g. passenger alarm override, uncoupling...).
- For speeds higher than 5 km/h, the maximum jerk due to the use of brakes shall be lower than 4 m/s³. The jerk behaviour may be derived from the calculation and from the evaluation of the deceleration behaviour as measured during the brake tests (as described in the clauses 6.2.3.8 and 6.2.3.9).

4.2.4.2.2 Safety requirements

- (1) The braking system is the means to stop a train, and therefore contributes to the safety level of the railway system.

The functional requirements expressed in clause 4.2.4.2.1 contribute to ensure safe functioning of the braking system; nevertheless, a risk based analysis is necessary to evaluate the braking performance, as many components are involved.

- (2) For the hazardous scenarios considered, the corresponding safety requirements shall be met, as defined in the table 3 below.

 OTIF	Uniform Technical Prescription (UTP)		UTP LOC&PAS	
	LOCOMOTIVES AND PASSENGER ROLLING STOCK		Page 63 of 272	
Status: DRAFT	Version: 03	TECH-20041 Annex	Original: EN	Date: 20.10.2020

Where a severity is specified within this table, it shall be demonstrated that the corresponding risk is controlled to an acceptable level, considering the functional failure with their typical credible potential to lead directly to that severity as defined within the table.

Table 3. *Braking system - safety requirements*

	Functional failure with its hazardous scenario	Safety requirement to be met	
		Associated severity/Consequence to be prevented	Minimum allowable number of combinations of failures
No.1	Applies to units fitted with a cab (brake command)		
	After activation of an emergency brake command no deceleration of the train due to failure in the brake system (complete and permanent loss of the brake force). <u>Note:</u> activation by the driver or by the CCS system to be considered. Activation by passengers (alarm) not relevant for the present scenario.	Fatalities	2 (no single failure is accepted)
No.2	Applies to units equipped with traction equipment		
	After activation of an emergency brake command, no deceleration of the train due to failure in the traction system (Traction force \geq Brake force).	Fatalities	2 (no single failure is accepted)
No.3	Applies to all units		
	After activation of an emergency brake command, the stopping distance is longer than the one in normal mode due to failure(s) in the brake system. <u>Note:</u> the performance in the normal mode is defined in clause 4.2.4.5.2.	NA	Single point(s) failure(s) leading to the longest calculated stopping distance shall be identified, and the increase of the stopping distance compared to the normal mode (no failure) shall be determined.

 OTIF	Uniform Technical Prescription (UTP)		UTP LOC&PAS	
	LOCOMOTIVES AND PASSENGER ROLLING STOCK		Page 64 of 272	
Status: DRAFT	Version: 03	TECH-20041 Annex	Original: EN	Date: 20.10.2020

No.4	Applies to all units		
	After activation of a parking brake command, no parking brake force applied (complete and permanent loss of the parking brake force).	NA	2 (no single failure is accepted)

Additional brake systems shall be considered in the safety study under the conditions specified in clauses 4.2.4.7 and 4.2.4.8.

The demonstration of compliance (conformity assessment procedure) is described in clause 6.2.3.5 of this

UTP.

~~TSI~~

4.2.4.3 Type of brake system

- (1) Units designed and assessed to be operated in general operation (various formations of vehicles from different origins; train formation not defined at design stage) on other track gauge systems than the 1520 mm system shall be fitted with a brake system with a brake pipe compatible with the UIC brake system. To this end, the specification referenced in Appendix J-1, index 22. "Requirements for the brake system of trains hauled by a locomotive" specifies the principles to be applied.

This requirement is set to ensure technical compatibility of the brake function between vehicles of various origins in a train.

- (2) There is no requirement on the type of brake system for units (trainsets or vehicles) assessed in fixed or predefined formation.

4.2.4.4 Brake command

4.2.4.4.1 Emergency braking command

- (1) This clause applies to units fitted with a driver's cab.
- (2) At least two independent emergency brake command devices shall be available, allowing the activation of the emergency brake by a simple and single action from the driver in his normal driving position, using one hand.

The sequential activation of these two devices may be considered in the demonstration of compliance to the safety requirement N°1 of table 3 of clause 4.2.4.2.2.

One of these devices shall be a red punch button (mushroom push button).

The emergency brake position of these two devices when activated shall be self locking by a mechanical device; unlocking this position shall be possible only by an intentional action.

- (3) The activation of the emergency brake shall also be possible by the Control-Command and signalling on-board system.

-

, as defined in the CCS TSI.

 OTIF	Uniform Technical Prescription (UTP)		UTP LOC&PAS	
	LOCOMOTIVES AND PASSENGER ROLLING STOCK		Page 65 of 272	
Status: DRAFT	Version: 03	TECH-20041 Annex	Original: EN	Date: 20.10.2020

- (4) Unless the command is cancelled, the emergency brake activation shall lead permanently, automatically to the following actions:
- transmission of an emergency brake command along the train by the brake control line.
 - cut-off of all tractive effort in less than 2 seconds; this cut-off shall not be able to be reset until the traction command is cancelled by the driver.
 - an inhibition of all “release brake” commands or actions.

4.2.4.4.2 *Service braking command*

- (1) This clause applies to units fitted with a driver’s cab.
- (2) The service brake function shall allow the driver to adjust (by application or release) the brake force between a minimum and a maximum value in a range of at least 7 steps (including brake release and maximum brake force), in order to control the speed of the train.
- (3) The service braking command shall be active only in one location in a train. To meet this requirement, it shall be possible to isolate the service braking function of the other service braking command(s) of the unit(s) part of a train formation, as defined for fixed and predefined formations.
- (4) When the speed of the train is higher than 15 km/h, the service brake activation by the driver shall lead automatically to the cut-off of all tractive effort; this cut-off shall not be reset until the traction command is cancelled by the driver.

Notes to points (1) – (4):

- in case of service brake and traction controlled by automatic speed regulation, the traction cut-off is not required to be cancelled by the driver.
- a friction brake may be used intentionally at speed higher than 15 km/h with traction for specific purpose (de-icing, cleaning of brake components...); it shall not be possible to use these particular functionalities in case of emergency or service brake activation.

4.2.4.4.3 *Direct braking command*

- (1) Locomotives (units designed to haul freight wagons or passenger carriages) assessed for general operation shall be fitted with a direct brake system.
- (2) The direct brake system shall allow the application of a brake force on the concerned unit(s) independently of the main brake command, with other unit(s) of the train remaining without brake applied.

4.2.4.4.4 *Dynamic braking command*

If a unit is equipped with a dynamic brake system:

- It shall be possible to prevent the use of regenerative braking on electric units so that there is no return of energy to the overhead contact line when driving on a line which does not allow that.

See also clause 4.2.8.2.3 for regenerative brake.

 OTIF	Uniform Technical Prescription (UTP)		UTP LOC&PAS	
	LOCOMOTIVES AND PASSENGER ROLLING STOCK		Page 66 of 272	
Status: DRAFT	Version: 03	TECH-20041 Annex	Original: EN	Date: 20.10.2020

- It is permitted to use a dynamic brake independently from other brake systems, or together with other brake systems (blending).
- Where on locomotives the dynamic brake is used independently from other brake systems, it shall be possible to limit the maximum value and rate of variation of the dynamic brake effort to predefined values.

Note: this limitation relates to the forces transmitted to the track when locomotive(s) is (are) integrated in a train; it may be applied at operating level by setting the values necessary for compatibility with a particular line (e.g. line with high gradient and low curve radius).

4.2.4.4.5 Parking braking command

- (1) This clause applies to all units.
- (2) The parking braking command shall lead to the application of a defined brake force for an unlimited period of time, during which a lack of any energy on board may occur.
- (3) It shall be possible to release the parking brake at standstill, including for rescue purposes.
- (4) For units assessed in fixed or pre-defined formations, and for locomotives assessed for general operation, the parking brake command shall be activated automatically when the unit is switched off. For other units, the parking brake command shall be either activated manually, or activated automatically when the unit is switched off.

Note to points (1) – (4): the application of the parking brake force may depend on the status of the main brake function; it shall be effective when the energy on board to apply the main brake function is lost or is going to increase or decrease (after having switched on or off the unit).

4.2.4.5 Braking performance

4.2.4.5.1 General requirements

- (1) The unit (trainset or vehicle) braking performance [deceleration = F (speed) and equivalent response time] shall be determined by calculation as defined in the specification referenced in Appendix J-1, index 23, considering a level track.
Each calculation shall be performed for wheel diameters corresponding to new, half-worn and worn wheels, and shall include the calculation of the required wheel/rail adhesion level (see clause 4.2.4.6.1).
- (2) The friction coefficients used by friction brake equipment and considered in the calculation shall be justified (see the specification referenced in Appendix J-1, index 24).
- (3) The braking performance calculation shall be performed for the two control modes: emergency brake and maximum service brake.
- (4) The braking performance calculation shall be performed at design stage, and shall be revised (correction of parameters) after the physical tests required in the clauses 6.2.3.8 and 6.2.3.9, in order to be consistent with test results.

The final braking performance calculation (consistent with test results) shall be part of the technical documentation specified in clause 4.2.12.

 OTIF	Uniform Technical Prescription (UTP)		UTP LOC&PAS	
	LOCOMOTIVES AND PASSENGER ROLLING STOCK		Page 67 of 272	
Status: DRAFT	Version: 03	TECH-20041 Annex	Original: EN	Date: 20.10.2020

- (5) The maximum average deceleration developed with all brakes in use, including the brake independent of wheel/rail adhesion, shall be lower than 2.5 m/s²; this requirement is linked to the longitudinal resistance of the track.

4.2.4.5.2 Emergency braking

Response time:

- (1) For units assessed in fixed formation(s) or pre-defined formation(s), the equivalent response time (*) and the delay time (*) evaluated on the total emergency braking force developed in case of the emergency brake command shall be lower than the following values:
- Equivalent response time:
 - 3 seconds for units of maximum design speed higher or equal to 250 km/h
 - 5 seconds for other units
 - Delay time: 2 seconds
- (2) For units designed and assessed for general operation, the response time shall be as specified for the UIC brake system (see also clause 4.2.4.3: the brake system shall be compatible with the UIC brake system).

(*): to be evaluated on the total brake force, or on pressure in brake cylinders in case of pneumatic brake system; definition according to the specification referenced in Appendix J-1, index 25, clause 5.3.3.

Calculation of the deceleration:

- (3) For all units, the emergency braking performance calculation shall be performed in accordance with the specification referenced in Appendix J-1, index 26; the deceleration profile and stopping distances at the following initial speeds (if lower than the maximum design speed of the unit) shall be determined: 30 km/h; 100 km/h; 120 km/h; 140 km/h; 160 km/h; 200 km/h; 230 km/h; 300 km/h; maximum design speed of the unit.
- (4) For units designed and assessed for general operation, the brake weight percentage (lambda) shall also be determined.
- The specification referenced in Appendix J-1, index 25, clause 5.12 specifies how other parameters [brake weight percentage (lambda), braked mass] can be derived from the calculation of the deceleration or from the stopping distance of the unit.
- (5) The emergency braking performance calculation shall be performed with a brake system in two different modes, and considering degraded conditions:
- **Normal mode:** no failure in the brake system and nominal value of the friction coefficients (corresponding to dry conditions) used by friction brake equipment. This calculation provides the braking performance normal mode.
 - **Degraded mode:** corresponding to the failures considered in clause 4.2.4.2.2, hazard no. 3, and nominal value of the friction coefficients used by friction brake equipment. Degraded mode shall consider possible single failures; to that end, the emergency braking performance shall be determined for the case of single point(s) failure(s) leading to the longest stopping distance, and the associated single failure shall be clearly identified (component involved and failure mode, failure rate if available).

 OTIF	Uniform Technical Prescription (UTP)		UTP LOC&PAS	
	LOCOMOTIVES AND PASSENGER ROLLING STOCK		Page 68 of 272	
Status: DRAFT	Version: 03	TECH-20041 Annex	Original: EN	Date: 20.10.2020

- Degraded conditions: in addition, the emergency braking performance calculation shall be performed with reduced values of the friction coefficient, with consideration of limit values for temperature and humidity (see the specification referenced in Appendix J-1, index 27, clause 5.3.1.4).

Note: these different modes and conditions have to be considered particularly when advanced Control Command and Signalling systems (such as ETCS) are implemented, aiming at optimising the railway system.

- (6) The emergency braking performance calculation shall be performed for the three following load conditions:
- minimum load: “design mass in working order” (as described in clause 4.2.2.10)
 - normal load: “design mass under normal payload” (as described in clause 4.2.2.10)
 - maximum braking load: load condition lower or equal to “design mass under exceptional payload” (as described in clause 4.2.2.10).

In case this load condition is lower than “design mass under exceptional payload, it shall be justified and documented in the general documentation described in clause 4.2.12.2.

- (7) Tests shall be performed to validate the emergency braking calculation, according to the conformity assessment procedure specified in clause 6.2.3.8.
- (8) For each load condition, the lowest result (i.e. leading to longest stopping distance) of the "emergency braking performance in normal mode" calculations at the design maximum speed (revised according to the results of tests required above) shall be recorded in the technical documentation defined in clause 4.2.12.2 of this

UTP.

~~TSI~~

- (9) Additionally, for units assessed in fixed or predefined formation of design maximum speed higher than or equal to 250 km/h, the stopping distance in case of "emergency braking performance in normal mode" shall not exceed the following values for the load condition “normal load”:
- 5360 m from the speed of 350 km/h (if \leq design maximum speed).
 - 3650 m from the speed 300 km/h (if \leq design maximum speed).
 - 2430 m from the speed 250 km/h.
 - 1500 m from the speed 200 km/h.

4.2.4.5.3 Service braking

Calculation of the deceleration:

- (1) For all units, the maximum service braking performance calculation shall be performed in accordance with the specification referenced in Appendix J-1, index 28 with a brake system in normal mode, with nominal value of the friction coefficients used by friction brake equipment for the load condition “design mass under normal payload” at the design maximum speed.
- (2) Tests shall be performed to validate the maximum service braking calculation, according to the conformity assessment procedure specified in clause 6.2.3.9.

 OTIF	Uniform Technical Prescription (UTP)		UTP LOC&PAS	
	LOCOMOTIVES AND PASSENGER ROLLING STOCK		Page 69 of 272	
Status: DRAFT	Version: 03	TECH-20041 Annex	Original: EN	Date: 20.10.2020

Maximum service braking performance:

- (3) When the service braking has higher design performance capability than the emergency braking, it shall be possible to limit the maximum service braking performance (by design of the braking control system, or as a maintenance activity) at a level lower than the emergency braking performance.

Note to points (1) – (3):

a Contracting State

~~a Member State~~

may ask the emergency braking performance to be at a higher level than the maximum service braking performance for safety reasons, but in any case it cannot prevent the access to a railway undertaking using a higher maximum service braking performance, unless that

a Contracting State

~~a Member State~~

is able to demonstrate that the national safety level is endangered.

4.2.4.5.4 Calculations related to thermal capacity

- (1) This clause applies to all units.
- (2) For OTMs, it is allowed to verify this requirement by temperature measurements on wheels and brake equipment.
- (3) The brake energy capacity shall be verified by calculation showing that the braking system in normal mode is designed to withstand the dissipation of the braking energy. The reference values used in this calculation for the components of the braking system that dissipate energy shall either be validated by a thermal test or by previous experience.

This calculation shall include the scenario consisting of 2 successive emergency brake applications from the maximum speed (time interval corresponding to the time needed to accelerate the train up to the maximum speed) on level track for the load condition “maximum braking load”.

In case of unit that cannot be operated alone as a train, the time interval between 2 successive emergency brake applications used in the calculation shall be reported.

- (4) The maximum line gradient, associated length and operating speed for which the brake system is designed in relation with brake thermal energy capacity shall also be defined by a calculation for the load condition “maximum braking load”, with the service brake being used to maintain the train at a constant operating speed.

The result (maximum line gradient, associated length and operating speed) shall be recorded in the rolling stock documentation defined in clause 4.2.12 of this

UTP.

~~TSI~~

The following “reference case” for the slope to be considered is suggested: maintain the speed of 80 km/h on a slope of 21 ‰ constant gradient over a distance of 46 km. If this reference case is used, the documentation may only mention the compliance to it.

- (5) For units assessed in fixed and predefined formation of design maximum speed higher than or equal to 250 km/h, they shall additionally be designed to operate with braking system in normal mode and load condition “maximum braking load” at speed equal to 90 % of the maximum operating speed on

 OTIF	Uniform Technical Prescription (UTP)		UTP LOC&PAS	
	LOCOMOTIVES AND PASSENGER ROLLING STOCK		Page 70 of 272	
Status: DRAFT	Version: 03	TECH-20041 Annex	Original: EN	Date: 20.10.2020

maximum descending gradient of 25 ‰ during 10 km, and on maximum descending gradient of 35 ‰ during 6 km.

4.2.4.5.5 *Parking brake*

Performance:

- (1) A unit (train or vehicle) in load condition “design mass in working order” without any power supply available, and stationary permanently on a 40 ‰ gradient, shall be kept immobilised.
- (2) Immobilisation shall be achieved by means of the parking brake function, and additional means (e.g. scotches) in case where the parking brake is unable to achieve the performance on its own; the required additional means shall be available on board the train.

Calculation:

- (3) The unit (train or vehicle) parking brake performance shall be calculated as defined in the specification referenced in Appendix J-1, index 29. The result (gradient where the unit is kept immobilized by the parking brake alone) shall be recorded in the technical documentation defined in clause 4.2.12 of this

UTP.

~~TSI~~

4.2.4.6 Wheel rail adhesion profile - Wheel slide protection system

4.2.4.6.1 *Limit of wheel rail adhesion profile*

- (1) The braking system of a unit shall be designed so that emergency brake performance (dynamic brake included if it contributes to the performance) and the service brake performance (without dynamic brake) do not assume a calculated wheel/rail adhesion for each wheelset in the speed range > 30 km/h and < 250 km/h higher than 0.15 with the following exceptions:
 - for units assessed in fixed or pre-defined formation(s) having 7 axles or less, the calculated wheel/rail adhesion shall not be higher than 0.13.
 - for units assessed in fixed or pre-defined formation(s) having 20 axles or more the calculated wheel/rail adhesion for the load case “minimum load” is permitted to be higher than 0.15, but shall not be higher than 0.17.

Note: for the load case “normal load”, there is no exception; the limit value of 0.15 applies.

This minimum number of axles may be reduced to 16 axles if the test required in section 4.2.4.6.2 related to the efficiency of the WSP system is performed for the load case “minimum load”, and provides positive result.

In the speed range > 250 km/h and ≤ 350 km/h, the three limit values above shall decline linearly in order to be reduced by 0.05 at 350 km/h.

- (2) The above requirement shall also apply for a direct brake command described in clause 4.2.4.4.3.
- (3) The design of a unit shall not assume wheel/rail adhesion higher than 0.12 when calculating the parking brake performance.
- (4) These limits of wheel rail adhesion shall be verified by calculation with the smallest wheel diameter, and with the 3 load conditions considered in clause 4.2.4.5.2.

 OTIF	Uniform Technical Prescription (UTP)		UTP LOC&PAS	
	LOCOMOTIVES AND PASSENGER ROLLING STOCK		Page 71 of 272	
Status: DRAFT	Version: 03	TECH-20041 Annex	Original: EN	Date: 20.10.2020

[Note to points \(1\) – \(4\)](#): All values of adhesion shall be rounded to two decimal places.

4.2.4.6.2 Wheel slide protection system (WSP)

A wheel slide protection system (WSP) is a system designed to make the best use of available adhesion by a controlled reduction and restoration of the brake force to prevent wheelsets from locking and uncontrolled sliding, thereby minimising the extension of stopping distances and possible wheel damage.

Requirements on the presence and use of a WSP system on the unit:

- Units designed for maximum service speed higher than 150 km/h shall be fitted with a WSP system.
- Units equipped with brake blocks on wheel running surface with a brake performance which assumes in the speed range > 30 km/h a calculated wheel/rail adhesion higher than 0.12 shall be fitted with a WSP system.
Units not equipped with brake blocks on wheel running surface with a brake performance which assumes in the speed range > 30 km/h a calculated wheel/rail adhesion higher than 0.11 shall be fitted with a WSP system.
- The requirement on the WSP system above shall apply to the two brake modes: emergency brake and service brake.

It shall also apply to the dynamic brake system, which is part of the service brake, and can be part of the emergency brake (see clause 4.2.4.7).

Requirements on the WSP system performance:

- For units equipped with a dynamic braking system, a WSP system (if present according to the point above) shall control the dynamic brake force; when this WSP system is not available, the dynamic brake force shall be inhibited, or limited in order not to lead a wheel/rail adhesion demand higher than 0.15.
- The wheel slide protection system shall be designed according to the specification referenced in Appendix J-1, index 30, clause 4, and verified according to the methodology defined in the specification referenced in Appendix J-1, index 30, clauses 5 and 6; when reference is made to the specification referenced in Appendix J-1, index 30, clause 6.2 “overview of required test programmes”, only the clause 6.2.3 applies, and it applies to all types of units.

Requirements on performance at unit level:

- If a unit is equipped with a WSP, a test shall be done to verify the efficiency of the WSP system (maximum extension of the stopping distance compared to stopping distance on dry rail) when integrated in the unit; the conformity assessment procedure is specified in clause 6.2.3.10.
- The relevant components of the wheel slide protection system shall be considered in the safety analysis of the emergency brake function required in clause 4.2.4.2.2.

Wheel rotation monitoring system (WRM):

 OTIF	Uniform Technical Prescription (UTP)		UTP LOC&PAS	
	LOCOMOTIVES AND PASSENGER ROLLING STOCK		Page 72 of 272	
Status: DRAFT	Version: 03	TECH-20041 Annex	Original: EN	Date: 20.10.2020

- Units of design maximum speed higher or equal to 250 km/h shall be equipped with a WRM system to advise the driver that an axle has seized; the WRM system shall be designed according to the specification referenced in Appendix J-1, index 30, clause 4.2.4.3.

4.2.4.7 Dynamic brake - Braking system linked to traction system

Where the braking performance of the dynamic brake or of braking system linked to the traction system is included in the performance of the emergency braking in normal mode defined in clause 4.2.4.5.2, the dynamic brake or the braking system linked to traction:

1. Shall be commanded by the main brake system control line (see clause 4.2.4.2.1).
2. Shall be subject to a safety analysis covering the hazard “after activation of an emergency command, complete loss of the dynamic brake force”.

This safety analysis shall be considered in the safety analysis required by the safety requirement N°3 set out in clause 4.2.4.2.2 for the emergency brake function.

For electric units, in case the presence on-board the unit of the voltage delivered by the external power supply is a condition for the dynamic brake application, the safety analysis shall cover failures leading to absence on-board the unit of that voltage.

In case the hazard above is not controlled at the level of the rolling stock (failure of the external power supply system), the braking performance of the dynamic brake or of braking system linked to the traction system shall not be included in the performance of the emergency braking in normal mode defined in clause 4.2.4.5.2.

4.2.4.8 Braking system independent of adhesion conditions

4.2.4.8.1 General

- (1) Brake systems able to develop a brake force applied on the rail, independent of the wheel/rail adhesion condition, are a means of providing additional braking performance when the requested performance is higher than the performance corresponding to the limit of the available wheel rail adhesion (see clause 4.2.4.6).
- (2) It is permissible to include the contribution of brakes independent of wheel/rail adhesion in the braking performance in normal mode defined in clause 4.2.4.5 for the emergency brake; in such a case, the brake system independent of adhesion condition:
- (3) Shall be commanded by the main brake system control line (see clause 4.2.4.2.1).
- (4) Shall be subject of a safety analysis covering the hazard “after activation of an emergency command, complete loss of the brake force independent of the wheel/rail adhesion”.

This safety analysis shall be considered in the safety analysis required by the safety requirement N°3 set out in clause 4.2.4.2.2 for the emergency brake function.

4.2.4.8.2 Magnetic track brake

- (1) Requirements on magnetic brakes specified [for compatibility with train detection system based on axle counters by the CCS subsystem](#) are referenced in [clause-point 4.2.3.3.1.2 \(10\)](#) of this

UTP.

TSI.

 OTIF	Uniform Technical Prescription (UTP)		UTP LOC&PAS	
	LOCOMOTIVES AND PASSENGER ROLLING STOCK		Page 73 of 272	
Status: DRAFT	Version: 03	TECH-20041 Annex	Original: EN	Date: 20.10.2020

- (2) A magnetic track brake is allowed to be used as an emergency brake,
unless the contrary is specified by a Contracting State in a National Technical Requirement which is in force according to APTU Article 12. | as mentioned in the INF TSI, clause 4.2.6.2.2.
- (3) The geometrical characteristics of the end elements of the magnet in contact with the rail shall be as specified for one of the types described in the specification referenced in Appendix J-1, index 31.
- (4) Magnetic track brake shall not be used at speed higher than 280 km/h.
- (5) The braking performance of the unit specified in clauses 4.2.4.5.2 of this UTP shall be determined with and without the use of magnetic track brakes.

4.2.4.8.3 Eddy current track brake

- (1) This clause covers only eddy current track brake developing a brake force between the ~~rolling stock unit~~ and the rail.
- (2) Requirements on eddy current track brakes specified for compatibility with train detection system based on axle counters, track circuits, wheel detectors and vehicle detectors based on inductive loops by the CCS subsystem are referenced in ~~clause-point~~ 4.2.3.3.1.2 (10) of this UTP. | ~~TSI~~
- (3) If the eddy current track brake requires a displacement of its magnets when the brake is applied, the unobstructed movement of such magnets between the “brake released” and “brake applied” positions shall be demonstrated by calculation in accordance with the specification referenced in Appendix J-1, index 14.
- (4) The maximum distance between the eddy current track brake and the track corresponding to “brake released” position will be recorded in the technical documentation described in clause 4.2.12 of this UTP.
- (5) The eddy current track brake shall not operate below a fixed speed threshold.
- (6) The conditions for use of eddy current track brake for technical compatibility with the track are not harmonised (regarding in particular their effect on rail heating and vertical force) ~~Therefore, requirements to be met by eddy current track brake and~~ are an open point.
- (7) The Infrastructure Manager shall provide information | The Register of Infrastructure indicates per track section
if their use is allowed, and provides in such case their conditions for use.
- The maximum distance between the eddy current track brake and the track corresponding to “brake released” referred to in point (4),
 - Fixed speed threshold referred to in point (5),
 - Vertical force as a function of the train speed, for the case of full application of eddy current track brake (emergency braking) and limited application of eddy current brake (service braking),

 OTIF	Uniform Technical Prescription (UTP)		UTP LOC&PAS	
	LOCOMOTIVES AND PASSENGER ROLLING STOCK		Page 74 of 272	
Status: DRAFT	Version: 03	TECH-20041 Annex	Original: EN	Date: 20.10.2020

– Braking force as a function of the train speed, for the case of full application of eddy current track brake (emergency braking) and limited application of eddy current brake (service braking).

(8) The braking performance of the unit specified in clauses 4.2.4.5.2 and 4.2.4.5.3 of this UTP shall be determined with and without the use of eddy current track brakes.

~~(1)(4) Until the “open point” is closed, the values of maximum longitudinal braking force applied to the track by the eddy current track brake~~

~~are~~

- ~~→ 105 kN for brake applications with a force less than 2/3 of full service braking,~~
- ~~→ Linear between 105 kN and 180 kN for brake applications between 2/3 and full service braking,~~
- ~~→ 180 kN for full service braking,~~
- ~~→ 360 kN in emergency braking,~~

~~considering the worst case and used at speed \geq 50 km/h.~~

~~These values are deemed to be compatible with high speed lines.~~

~~specified in the clause 4.2.4.5 of the HS RST 2008 TSI and used at speed \geq 50 km/h are deemed to be compatible with HS lines.~~

4.2.4.9 Brake state and fault indication

- (1) Information available to train staff shall allow the identification of degraded conditions concerning the rolling stock (brake performance lower than the performance required), for which specific operating rules apply. To that end, it shall be possible at certain phases during operation for the train staff to identify the status (applied or released or isolated) of the main (emergency and service) and parking brake systems, and the status of each part (including one or several actuators) of these systems that can be controlled and/or isolated independently.
- (2) If the parking brake always depends directly on the state of main brake system, it is not required to have an additional and specific indication for the parking brake system.
- (3) The phases that shall be considered during operation are standstill and running.
- (4) When at a standstill, train staff shall be able to check from inside and/or outside of the train:
 - The continuity of the train brake control command line,
 - The availability of the braking energy supply along the train,
 - The status of the main brake and parking brake systems and the status of each part (including one or several actuators) of these systems that can be controlled and/or isolated separately (as described above in the first paragraph of this clause), excepted for dynamic brake and braking system linked to traction systems.
- (5) When running, the driver shall be able to check from the driving position in the cab:
 - The status of the train brake control command line,

 OTIF	Uniform Technical Prescription (UTP)		UTP LOC&PAS	
	LOCOMOTIVES AND PASSENGER ROLLING STOCK		Page 75 of 272	
Status: DRAFT	Version: 03	TECH-20041 Annex	Original: EN	Date: 20.10.2020

- The status of the train brake energy supply,
- The status of the dynamic brake and braking system linked to traction system where they are included in the performance of the emergency braking in normal mode,
- The status applied or released of at least one part (actuator) of the main brake system which is controlled independently (e.g. a part which is installed on the vehicle fitted with an active cab).

(6) The function providing the information described above to the train staff is a function essential to safety, as it is used for the train staff to evaluate the braking performance of the train.

Where local information is provided by indicators, the use of harmonised indicators ensures the required safety level.

Where a centralised control system allowing the train staff to perform all checks from one location (i.e. inside the drivers cab) is provided, it shall be subject to a reliability study, considering the failure mode of components, redundancies, periodic checks and other provisions; based on this study, operating conditions of the centralised control system shall be defined and provided in the operating documentation described in clause 4.2.12.4.

(7) Applicability to units intended for general operation:

Only functionalities that are relevant to the design characteristics of the unit (e.g. presence of a cab, ...) shall be considered.

The signals transmission required (if any) between the unit and the other coupled unit(s) in a train for the information regarding the brake system to be available at train level shall be documented, taking into account functional aspects.

This

UTP

TSI

does not impose any technical solution regarding physical interfaces between units.

4.2.4.10 Brake requirements for rescue purposes

(1) All brakes (emergency, service, parking) shall be fitted with devices allowing their release and isolation. These devices shall be accessible and functional whether the train or vehicle is: powered, non-powered or immobilised without any available energy on board.

(2) For units intended to be operated on other track gauge systems than 1520 mm system, it shall be possible, following a failure during operation, to rescue a train with no energy available on board by a recovery power unit equipped with a pneumatic brake system compatible with the UIC brake system (brake pipe as braking control command line).

Note: see clause 4.2.2.2.4 of this

UTP

TSI

for mechanical and pneumatical interfaces of the recovery unit.

(3) During the rescue, it shall be possible to have a part of the brake system of the rescued train controlled by means of an interface device; in order to meet this requirement, it is allowed to rely on low voltage provided by a battery to supply control circuits on the rescued train.

 OTIF	Uniform Technical Prescription (UTP)		UTP LOC&PAS	
	LOCOMOTIVES AND PASSENGER ROLLING STOCK		Page 76 of 272	
Status: DRAFT	Version: 03	TECH-20041 Annex	Original: EN	Date: 20.10.2020

- (4) The braking performance developed by the rescued train in this particular operating mode shall be evaluated by a calculation, but is not required to be the same as the braking performance described in clause 4.2.4.5.2. The calculated braking performance and rescue operating conditions shall be part of the technical documentation described in clause 4.2.12.
- (5) This requirement does not apply to units which are operated in a train formation of less than 200 tons (load condition “design mass in working order”).

4.2.5 Passenger related items

Vehicles in international traffic that are intended to carry passengers shall meet the requirements as set out in UTP PRM to cover parameters such as:

For information purposes only, the following non exhaustive list gives an overview of the basic parameters covered by the PRM TSI, which are applicable to units which are intended to carry passengers:

- seats, including priority seats
- wheelchair spaces
- exterior doors, including dimensions, passenger interface for controls
- interior doors, including dimensions, passenger interface for controls
- toilets
- clearways
- lighting
- customer Information
- floor height changes
- handrails
- wheelchair accessible sleeping accommodation
- step position for vehicle access and egress, including steps and boarding aids.

Additional requirements are specified below in this clause.

4.2.5.1 Sanitary systems

- (1) If a water tap is provided in a unit and unless the water is provided from the tap in accordance with Directive 98/83/EC⁹,

or according to the regulations in the Contracting State that prescribe at least equivalent water conditions as in the above-mentioned Directive,

a visual sign shall clearly indicate that the water provided at the tap is not drinkable.

⁹- OJ L 330, 05.12.1998, p.32

 OTIF	Uniform Technical Prescription (UTP)		UTP LOC&PAS	
	LOCOMOTIVES AND PASSENGER ROLLING STOCK		Page 77 of 272	
Status: DRAFT	Version: 03	TECH-20041 Annex	Original: EN	Date: 20.10.2020

(2) Sanitary systems (toilets, washrooms, bar/restaurant facilities) where fitted shall not allow the release of any material that may be detrimental to the health of people or to the environment. Released materials (i.e. treated water; water with soap directly released from washrooms excluded) shall be conformant to the applicable European regulations under the Water Framework Directive

, or applicable regulations in the Contracting State that prescribe at least equivalent or better conditions for released materials than the European regulations under the Water Framework Directive referred to:

- The bacterial content of water discharged from sanitary systems shall not at any time exceed the bacterial content value for Intestinal enterococci and Escherichia coli bacteria specified as ‘good’ for Inland waters in European Directive 2006/7/EC¹⁰

, or according to the regulations in the Contracting State that prescribe a lower or equivalent content of the above-mentioned bacteria compared to the above-mentioned Directive,

concerning the management of bathing water quality.

- The treatment processes shall not introduce substances that are identified in Annex I of Directive 2006/11/EC¹¹

, or regulations applicable in the Contracting States with equivalent content,

on pollution caused by certain dangerous substances discharged into the aquatic environment of the

Contracting State.

Union.

(3) To limit the dispersion of released liquid on the trackside, uncontrolled discharge from any source shall take place downwards only, under the body frame of the vehicle in a distance not greater than 0,7 metres from the longitudinal centre line of the vehicle.

(4) The following shall be provided in the technical documentation described in clause 4.2.12:

- The presence and type of toilets in a unit,
- The characteristics of the flushing medium, if it is not clean water,
- The nature of the treatment system for released water and the standards against which conformity has been assessed.

¹⁰ OJ L 64, 04.03.2006, p.37

¹¹ OJ L 64, 04.03.2006, p.52

 OTIF	Uniform Technical Prescription (UTP)		UTP LOC&PAS	
	LOCOMOTIVES AND PASSENGER ROLLING STOCK		Page 78 of 272	
Status: DRAFT	Version: 03	TECH-20041 Annex	Original: EN	Date: 20.10.2020

4.2.5.2 Audible communication system

- (1) This clause applies to all units designed to carry passengers and units designed to haul passenger trains.
- (2) Trains shall be equipped as a minimum with a means of audible communication:
 - for the train crew to address the passengers in a train
 - for internal communication between the train crew and in particular between the driver and staff in the passenger area (if any).
- (3) The equipment shall be able to remain on standby independently of the main energy source for at least three hours. During the standby time the equipment shall be able to actually function at random intervals and periods during an accumulated time of 30 minutes.
- (4) The communication system shall be designed in such a manner that it continues to operate at least half (distributed throughout the train) of its loudspeakers in the event of a failure in one of its transmission elements or, as an alternative, another means shall be available to inform the passengers in the event of a failure.
- (5) Provisions for passengers to contact train crew are prescribed in clause 4.2.5.3 (passenger alarm) and in clause 4.2.5.4 (communication devices for passengers)

- (6) Applicability to units intended for general operation:

Only functionalities that are relevant to the design characteristics of the unit (e.g. presence of a cab, of a crew interface system, ...) shall be considered.

The signals transmission required between the unit and the other coupled unit(s) in a train for the communication system to be available at train level shall be implemented and documented, taking into account functional aspects.

This

UTP

TSI

does not impose any technical solution regarding physical interfaces between units.

4.2.5.3 Passenger alarm

4.2.5.3.1 General

- (1) This clause is applicable to all units designed to carry passengers and units designed to haul passenger trains.
- (2) The passenger alarm function gives to anyone in the train the opportunity to advise the driver of a potential danger, and has consequences at operating level when activated (e.g. braking initiation in absence of reaction from the driver); it is a safety related function, for which the requirements, including safety aspects, are set out in this clause.

4.2.5.3.2 Requirements for information interfaces

- (1) With the exception of toilets and gangways, each compartment, each entrance vestibule and all other separated areas intended for passengers shall be equipped with at least one clearly visible and indicated alarm device to inform the driver of a potential danger.

 OTIF	Uniform Technical Prescription (UTP)		UTP LOC&PAS	
	LOCOMOTIVES AND PASSENGER ROLLING STOCK		Page 79 of 272	
Status: DRAFT	Version: 03	TECH-20041 Annex	Original: EN	Date: 20.10.2020

- (2) The alarm device shall be designed so that once activated it cannot be cancelled by passengers.
- (3) At the triggering of the passenger alarm, both visual and acoustic signs shall indicate to the driver that one or more passenger alarms have been activated.
- (4) A device in the cab shall allow the driver to acknowledge his awareness of the alarm. The driver's acknowledgement shall be perceivable at the place where the passenger alarm was triggered and shall stop the acoustic signal in the cab.
- (5) On the driver's initiative, the system shall allow a communication link to be established between the driver's cab and the place where the alarm(s) was/were triggered for units designed for operation without staff on-board (other than driver). For units designed for operation with staff on-board (other than driver), it is permitted to have this communication link established between the driver's cab and the staff on-board.

The system shall allow the driver to cancel this communication link on his initiative.

- (6) A device shall enable the crew to reset the passenger alarm.

4.2.5.3.3 *Requirements for activation of the brake by the passenger alarm*

- (1) When the train is stopped at a platform or departing from a platform, activation of a passenger alarm shall lead to a direct application of the service brake or the emergency brake, resulting in a complete stop. In this case, only after the train has come to a complete stop, a system shall allow the driver to cancel any automatic braking action initiated by the passenger alarm;
- (2) In other situations, 10 +/-1 seconds after activation of the (first) passenger alarm, at least an automatic service brake shall be initiated unless the passenger alarm is acknowledged by the driver within this time. The system shall allow the driver to override at any time an automatic braking action initiated by the passenger alarm.

4.2.5.3.4 *Criteria for a train departing from a platform*

- (1) A train is deemed to be departing from a platform during the period of time elapsing between the moment when door status is changed from 'released' to 'closed and locked' and the moment when the train has partly left the platform.
- (2) This moment shall be detected on-board (function allowing physical detection of the platform or based on speed or distance criteria, or any alternative criteria).
- (3) For units intended to operate on lines that are fitted with the ETCS track side system for control-command and signalling (including "passenger door" information

with references to Appendix J-2, index 3 of this UTP), as described in Annex A Index 7 of CCS TSI¹²),

¹² Commission Decision 2012/88/EU of 25 January 2012 on the technical specification for interoperability relating to the control-command and signalling subsystems of the trans-European rail system (notified under document C(2012) 172) (OJ L 51, 23.02.2012, p.1-65)

 OTIF	Uniform Technical Prescription (UTP)		UTP LOC&PAS	
	LOCOMOTIVES AND PASSENGER ROLLING STOCK		Page 80 of 272	
Status: DRAFT	Version: 03	TECH-20041 Annex	Original: EN	Date: 20.10.2020

this on-board device shall be able to receive from the ETCS system the information related to platform.

4.2.5.3.5 Safety requirements

- (1) For the scenario “failure in the passenger alarm system leading to the impossibility for a passenger to initiate the activation of brake in order to stop the train when train departs from a platform”, it shall be demonstrated that the risk is controlled to an acceptable level considering that the functional failure has typical credible potential to lead directly to “single fatality and/or severe injury”.
- (2) For the scenario “failure in the passenger alarm system leading to no information given to the driver in case of activation of a passenger alarm”, it shall be demonstrated that the risk is controlled to an acceptable level considering that the functional failure has typical credible potential to lead directly to “single fatality and/or severe injury”.
- (3) The demonstration of conformity (conformity assessment procedure) is described in clause 6.2.3.5 of this

UTP.

~~TSI~~

4.2.5.3.6 Degraded mode

- (1) Units fitted with a driver’s cab shall be fitted with a device which allows authorised staff to isolate the passenger alarm system.
- (2) If the passenger alarm system is not functioning, either after intentional isolation by staff, due to a technical failure, or by coupling the unit with a non-compatible unit, this shall be permanently indicated to the driver in the active driver’s cab, and application of the passenger alarm shall result in a direct application of brakes.
- (3) A train with an isolated passenger alarm system does not meet the minimum requirements for safety and interoperability as defined in this

UTP

~~TSI~~

and shall therefore be regarded to as being in degraded mode.

4.2.5.3.7 Applicability to units intended for general operation

- (1) Only functionalities that are relevant to the design characteristics of the unit (e.g. presence of a cab, of a crew interface system...) shall be considered.
- (2) The signals transmission required between the unit and the other coupled unit(s) in a train for the passenger alarm system to be available at train level shall be implemented and documented, taking into account functional aspects described above in this clause.
- (3) This

 OTIF	Uniform Technical Prescription (UTP)		UTP LOC&PAS	
	LOCOMOTIVES AND PASSENGER ROLLING STOCK		Page 81 of 272	
Status: DRAFT	Version: 03	TECH-20041 Annex	Original: EN	Date: 20.10.2020

UTP

~~TSI~~

does not impose any technical solution regarding physical interfaces between units.

4.2.5.4 Communication devices for passengers

- (1) This clause applies to all units designed to carry passengers and units designed to haul passenger trains.
- (2) Units designed for operation without staff on-board (other than driver) shall be equipped with a 'communication device' for passengers to inform a person who can take appropriate action.
- (3) The requirements to the location of the 'communication device' are the ones applicable for the passenger alarm as defined in clause 4.2.5.3 'Passenger alarm: functional requirements'.
- (4) The system shall allow the communication link to be requested on the initiative of the passenger. The system shall allow the person receiving the communication (e.g. driver) to cancel this communication link at his initiative.
- (5) The 'communication device' interface to passengers shall be indicated by a harmonised sign, shall include visual and tactile symbols and shall emit a visual and audible indication that it has been operated. These elements shall be in accordance with the

UTP PRM.

~~PRM-TSI.~~

- (6) Applicability to units intended for general operation:

Only functionalities that are relevant to the design characteristics of the unit (e.g. presence of a cab, of a crew interface system...) shall be considered.

The signals transmission required between the unit and the other coupled unit(s) in a train for the communication system to be available at train level shall be implemented and documented, taking into account functional aspects.

This

UTP

~~TSI~~

does not impose any technical solution regarding physical interfaces between units.

4.2.5.5 Exterior doors: passenger access to and egress from Rolling Stock

4.2.5.5.1 General

- (1) This clause applies to all units designed to carry passengers and units designed to haul passenger trains.
- (2) Doors intended for staff and freight are dealt with in clauses 4.2.2.8 and 4.2.9.1.2 of this

UTP.

~~TSI.~~

- (3) The control of external passenger access doors is a function essential to safety; the functional and safety requirements expressed in this clause are necessary to ensure the safety level required.

 OTIF	Uniform Technical Prescription (UTP)		UTP LOC&PAS	
	LOCOMOTIVES AND PASSENGER ROLLING STOCK		Page 82 of 272	
Status: DRAFT	Version: 03	TECH-20041 Annex	Original: EN	Date: 20.10.2020

4.2.5.5.2 Terminology used

- (1) In the context of this clause a “door” is an external passenger access door (with one or more leaves), intended primarily for passengers to enter and leave the unit.
- (2) A “locked door” is a door held closed by a physical door locking device.
- (3) A “door locked out of service” is a door immobilised in a closed position by a manually operated mechanical locking device.
- (4) A door “released” is a door that is able to be opened by operating the local or, central door control, (where the latter is available).
- (5) For the purpose of this clause, a train is assumed to be at a standstill when the speed has decreased to 3 km/h or less.
- (6) For the purpose of this clause, “train crew” means one member of the on-board staff in charge of the checks related to the door system; it may be the driver or another member of the on-board staff.

4.2.5.5.3 Door closing and locking

- (1) The door control device shall allow the train crew to close and lock all the doors before the train departs.
- (2) Where a movable step has to be retracted, the closing sequence shall include the movement of the step to the retracted position.
- (3) When the centralised door closing and locking is activated from a local control, adjacent to a door, it is permissible for this door to remain open when the other doors close and lock. The door control system shall allow the staff to close and lock this door subsequently before departure.
- (4) The doors shall be kept closed and locked until they are released in accordance with clause 4.2.5.5.6 ‘Door opening’. In the event of loss of power to the door controls, the doors shall be kept locked by the locking mechanism.

Note to points (1) – (4): see clause 4.2.2.4.2 of

UTP PRM

PRM-TSI

for alert signal when closing a door.

Door obstacle detection:

- (5) External passenger access doors shall incorporate devices that detect if they close on an obstacle (e.g. a passenger). Where an obstacle is detected the doors shall automatically stop, and remain free for a limited period of time or reopen. The sensitivity of the system shall be such as to detect an obstacle according to the specification referenced in Appendix J-1, index 32, clause 5.2.1.4.1, with a maximum force on the obstacle according to the specification referenced in Appendix J-1, index 32, clause 5.2.1.4.2.1.

4.2.5.5.4 Locking a door out of service

- (1) A manually operated mechanical device shall be provided to enable (the train crew or maintenance staff) to lock a door out of service.

 OTIF	Uniform Technical Prescription (UTP)		UTP LOC&PAS	
	LOCOMOTIVES AND PASSENGER ROLLING STOCK		Page 83 of 272	
Status: DRAFT	Version: 03	TECH-20041 Annex	Original: EN	Date: 20.10.2020

(2) The locking out of service device shall:

- Isolate the door from any opening command
- Lock the door mechanically in the closed position
- Indicate the status of the isolation device
- Permit the door to be by-passed by the ‘door-closed proving system’

4.2.5.5.5 Information available to the train crew

- (1) An appropriate ‘doors-closed proving system’ shall allow the train crew to check at any moment whether or not all the doors are closed and locked.
- (2) If one or more doors are not locked, this shall be continuously indicated to the train crew.
- (3) An Indication shall be provided to the train crew of any fault of a door closing and/or locking operation.
- (4) Audible and visual alarm signal shall indicate to the train crew an emergency opening of one or more doors.
- (5) A “door locked out of service” is permitted to be by-passed by the ‘doors-closed proving system’.

4.2.5.5.6 Door opening

- (1) A train shall be provided with door release controls, which allow the train crew or an automatic device associated with the stop at a platform, to control the release of doors separately on each side, allowing them to be opened by passengers or, if available, by a central opening command when the train is at a standstill.
- (2) For units intended to operate on lines that are fitted with the ETCS track side system for control-command and signalling (including “passenger door” information with references to Appendix J-2, index 3 of this UTP), as described in Annex A Index 7 of CCS TSI), this door release control system shall be able to receive from the ETCS system the information related to platform.
- (3) At each door, local opening controls or opening devices shall be accessible for passengers from both the outside and the inside of the vehicle.
- (4) Where a movable step has to be deployed, the opening sequence shall include the movement of the step to the deployed position.

Note: see

clause 4.2.2.4.2 of UTP PRM

clause 4.2.2.4.2 of PRM TSI

for alert signal when opening a door.

 OTIF	Uniform Technical Prescription (UTP)		UTP LOC&PAS	
	LOCOMOTIVES AND PASSENGER ROLLING STOCK		Page 84 of 272	
Status: DRAFT	Version: 03	TECH-20041 Annex	Original: EN	Date: 20.10.2020

4.2.5.5.7 Door-traction interlock

- (1) Traction power shall be applied only when all doors are closed and locked. This shall be ensured through an automatic door-traction interlock system. The door-traction interlock system shall prevent traction power being applied when not all of the doors are closed and locked.
- (2) The traction interlock system shall be provided with a manual override, intended to be activated by the driver in exceptional situations, to apply traction even when not all of the doors are closed and locked.

4.2.5.5.8 Safety requirements for clauses 4.2.5.5.2 to 4.2.5.5.7

- (1) For the scenario “one door is unlocked (with train crew not correctly informed of this door status) or released or opened in inappropriate areas (e.g. wrong side of train) or situations (e.g. train running), it shall be demonstrated that the risk is controlled to an acceptable level, considering that the functional failure has typical credible potential to lead directly to:
 - “single fatality and/or severe injury” for units in which passengers are not supposed to stay in standing position in the door area (long distance), or to
 - “single fatality and/or severe injury” for units in which some passengers stay in standing position in the door area in normal operation.
- (2) For the scenario “several doors are unlocked (with train crew not correctly informed of this door status) or released or opened in inappropriate areas (e.g. wrong side of the train) or situations (e.g. train running), it shall be demonstrated that the risk is controlled to an acceptable level, considering that the functional failure has typical credible direct potential to lead to:
 - “fatality and/or severe injury” for units in which passengers are not supposed to stay in standing position in the door area (long distance), or to
 - “fatalities and/or severe injuries” for units in which some passengers stay in standing position in the door area in normal operation.
- (3) The demonstration of conformity (conformity assessment procedure) is described in clause 6.2.3.5 of this

UTP.

~~TSI~~

4.2.5.5.9 Door emergency opening

Internal emergency opening:

- (1) Each door shall be provided with an individual internal emergency-opening device accessible to passengers that shall allow the door to open; this device shall be active when the speed is below 10 km/h.
- (2) It is allowed to have this device active at any speed (independent of any speed signal); in such a case, this device shall be operated after a succession of at least two actions.
- (3) This device is not required to have an effect on “a door locked out of service”. In such a case the door may be unlocked first.

Safety requirement:

 OTIF	Uniform Technical Prescription (UTP)		UTP LOC&PAS	
	LOCOMOTIVES AND PASSENGER ROLLING STOCK		Page 85 of 272	
Status: DRAFT	Version: 03	TECH-20041 Annex	Original: EN	Date: 20.10.2020

- (4) For the scenario “failure in the internal emergency opening system of two adjacent doors along a through route (as defined in clause 4.2.10.5 of this

UTP),

~~TSI~~,

the emergency opening system of other doors remaining available”, it shall be demonstrated that the risk is controlled to an acceptable level, considering that the functional failure has typical credible potential to lead directly to “single fatality and/or severe injury”.

The demonstration of compliance (conformity assessment procedure) is described in clause 6.2.3.5 of this

UTP.

~~TSI~~

External emergency opening:

- (5) Each door shall be provided with an individual external emergency-opening device, accessible to rescue staff, to allow that door to be opened for emergency reasons. This device is not required to have an effect on “a door locked out of service”. In such a case the door shall be unlocked first.

Manual force to open the door:

- (6) For manual opening of the door, the force required to be exerted by a person shall be according to the specification referenced in Appendix J-1, index 33.

4.2.5.5.10 Applicability to units intended for general operation

- (1) Only functionalities that are relevant to the design characteristics of the unit (e.g. presence of a cab, of a crew interface system for door control...) shall be considered.
- (2) The signals transmission required between the unit and the other coupled unit(s) in a train for the door system to be available at train level shall be implemented and documented, taking into account functional aspects.

- (3) This

UTP

~~TSI~~

does not impose any technical solution regarding physical interfaces between units.

4.2.5.6 Exterior door system construction

- (1) If a unit is fitted with a door intended to be used by passengers to access or egress the train, the following provisions apply:
- (2) Doors shall be fitted with transparent windows to allow passengers to identify the presence of a platform.
- (3) The outside surface of passenger units shall be designed in such a way that they do not give the possibility for a person to “train surf” when the doors are closed and locked.
- (4) As a measure to prevent “train surfing”, handholds on the outside surface of the door system shall be avoided or designed so that they cannot be gripped when the doors are closed.

 OTIF	Uniform Technical Prescription (UTP)		UTP LOC&PAS	
	LOCOMOTIVES AND PASSENGER ROLLING STOCK		Page 86 of 272	
Status: DRAFT	Version: 03	TECH-20041 Annex	Original: EN	Date: 20.10.2020

- (5) Handrails and handholds shall be fixed so that they can withstand the forces exerted on them during operation.

4.2.5.7 Inter-unit doors

- (1) This clause is applicable to all units designed to carry passengers.
- (2) Where a unit is equipped with inter-unit doors at the end of coaches or at unit-ends, they shall be fitted with a device that allows them to be locked (e.g. where a door is not connected by a gangway for use of passengers to an adjacent coach or unit, etc.).

4.2.5.8 Internal air quality

- (1) The quantity and quality of air provided inside the area of vehicles occupied by passengers and/or staff shall be such that no risk is developed to the health of passengers or staff additional to those resulting from the external ambient air quality. This is achieved by complying with the requirements set up below.

A ventilation system shall maintain an acceptable interior CO₂ level under operational conditions.

- (2) The CO₂ level shall not exceed 5000 ppm in all operating conditions, excepted in the 2 cases below:
- In case of interruption of the ventilation, due to an interruption of the main power supply or to a breakdown of the system, an emergency provision shall ensure the supply of outside air into all passenger and staff areas.

If this emergency provision is ensured through battery supplied forced ventilation, the duration in which the CO₂ level will remain below 10000 ppm shall be defined, assuming a passenger load derived from the load condition ‘design mass under normal payload’.

The conformity assessment procedure is defined in clause 6.2.3.12.

This duration shall not be less than 30 minutes.

The duration shall be recorded in the technical documentation defined in clause 4.2.12 of this

UTP.

~~TSI~~

- In case of switch off or closing of all means of external ventilation, or switch off of air conditioning system, in order to prevent passengers being exposed to environmental fumes that may be present, especially in tunnels, and in the event of a fire, as described in clause 4.2.10.4.2.

4.2.5.9 Body side windows

- (1) Where body side windows can be opened by passengers and cannot be locked by the train staff, the size of the opening shall be limited to such dimensions that it is not possible to pass a ball shaped object with 10 cm diameter through it.

4.2.6 Environmental conditions and aerodynamic effects

4.2.6.1 Environmental conditions - general

- (1) Environmental conditions are physical, chemical or biological conditions external to a product and to which it is subjected to.

 OTIF	Uniform Technical Prescription (UTP)		UTP LOC&PAS	
	LOCOMOTIVES AND PASSENGER ROLLING STOCK		Page 87 of 272	
Status: DRAFT	Version: 03	TECH-20041 Annex	Original: EN	Date: 20.10.2020

- (2) The environmental conditions to which rolling stock is subjected to influence the design of rolling stock, as well as this of its constituents.
- (3) The environmental parameters are described in the clauses below; for each environmental parameter, a nominal range is defined, which is the most commonly encountered in Europe, and is the basis for interoperable rolling stock.

- (4) For certain environmental parameters, ranges other than the nominal one are defined; in that case, a range shall be selected for the design of the rolling stock.

For the functions identified in the clauses below, design and/or testing provisions taken to ensure that the rolling stock is meeting the

UTP | ~~TSI~~

requirements in this range shall be described in the technical documentation.

- (5) The selected range(s) shall be recorded in the technical documentation described in clause 4.2.12 of this

UTP, | ~~TSI~~

as a characteristic of the rolling stock.

- (6) Depending on the ranges selected, and on provisions taken (described in the technical documentation), relevant operating rules could be necessary to ensure the technical compatibility between the rolling stock and environmental conditions that can be met on parts of the network.

In particular, operating rules are necessary when rolling stock designed for the nominal range is operated on a particular line where the nominal range is exceeded at certain periods of the year.

- (7) The ranges, if different than the nominal one, to be selected to avoid any restrictive operating rule(s) linked to a geographical area and climatic conditions, are specified by the Member States and are listed in the clause 7.4 of this

UTP. | ~~TSI~~

4.2.6.1.1 Temperature

- (1) Rolling stock shall meet the requirements of this

UTP | ~~TSI~~

within one (or several) of the temperature ranges T1 (-25°C to +40°C; nominal), or T2 (-40°C to +35°C) or T3 (-25°C to +45°C) as defined in the specification referenced in Appendix J-1, index 34

- (2) The selected temperature range (s) shall be recorded in the technical documentation described in clause 4.2.12 of this

UTP. | ~~TSI~~

- (3) The temperature to consider for design purpose of rolling stock constituents shall take into account their integration in the rolling stock.

 OTIF	Uniform Technical Prescription (UTP)		UTP LOC&PAS	
	LOCOMOTIVES AND PASSENGER ROLLING STOCK		Page 88 of 272	
Status: DRAFT	Version: 03	TECH-20041 Annex	Original: EN	Date: 20.10.2020

4.2.6.1.2 Snow, ice and hail

(1) Rolling stock shall meet the requirements of this

UTP ~~TSI~~

when subject to snow, ice and hail conditions as defined in the specification referenced in Appendix J-1, index 35, which correspond to the nominal conditions (range).

(2) The effect of snow, ice and hail to consider for design purpose of rolling stock constituents shall take into account their integration in the rolling stock.

(3) Where more severe “snow, ice and hail“ conditions are selected, rolling stock and the parts of the subsystem shall then be designed to meet

UTP ~~TSI~~

requirements considering the following scenarios:

- Snowdrift (light snow with low water equivalent content), covering the track up to 80 cm continuously above top rail level.
- Powder snow, snowfall of large quantities of light snow with low water equivalent content.
- Temperature gradient, temperature and humidity variation during one single run causing ice build-ups on the rolling stock.
- Combined effect with low temperature according to the temperature zone chosen as defined in clause 4.2.6.1.1.

(4) In relation with clause 4.2.6.1.1 (climatic zone T2) and with the present clause 4.2.6.1.2 (severe conditions for snow, ice and hail) of this

UTP, ~~TSI~~

the provisions taken to meet

UTP ~~TSI~~

requirements in these severe conditions shall be identified and verified, in particular design and/or testing provisions that are required for the following

UTP ~~TSI~~

requirements:

- Obstacle deflector as defined in this

UTP ~~TSI~~

clause 4.2.2.5: additionally, capability to remove snow in front of the train.

Snow shall be considered as an obstacle to be removed by the obstacle deflector; the following requirements are defined in clause 4.2.2.5 (by reference to the specification referenced in Appendix J-1, index 36):

 OTIF	Uniform Technical Prescription (UTP)		UTP LOC&PAS	
	LOCOMOTIVES AND PASSENGER ROLLING STOCK		Page 89 of 272	
Status: DRAFT	Version: 03	TECH-20041 Annex	Original: EN	Date: 20.10.2020

“The obstacle deflector needs to be of sufficient size to sweep obstacles clear of the path of the bogie. It shall be a continuous structure and shall be designed so as not to deflect objects upwards or downwards. Under normal operating conditions, the lower edge of the obstacle deflector shall be as close to the track as the vehicle movements and gauge line will permit.

In plan view the deflector should approximate to a ‘V’ profile with an included angle of not more than 160°. It can be designed with a compatible geometry to function also as a snow plough.”

The forces specified in clause 4.2.2.5 of this

UTP | ~~TSI~~

are deemed to be sufficient in order to remove the snow.

- Running gear as defined in the

UTP | ~~TSI~~

clause 4.2.3.5: considering snow and ice build-up and possible consequence on running stability and brake function.

- Brake function and brake power supply as defined in the

UTP | ~~TSI~~

clause 4.2.4.

- Signalling the presence of the train to others as defined in the

UTP | ~~TSI~~

clause 4.2.7.3.

- Providing a view ahead as defined in the

UTP | ~~TSI~~

clause 4.2.7.3.1.1 (head lights) and 4.2.9.1.3.1 (front visibility), with windscreen’s equipment as defined in clause 4.2.9.2 functioning.

- Providing the driver with acceptable climate for working as defined in the

UTP | ~~TSI~~

clause 4.2.9.1.7.

- (5) The selected range for “snow, ice and hail” (nominal or severe) and provision adopted shall be documented in the technical documentation described in clause 4.2.12.2 of this

UTP. | ~~TSI.~~

4.2.6.2 Aerodynamic effects

- (1) The requirements in this clause apply to all rolling stock. ~~For rolling stock except those designed to be operated on the 1520 mm and or 1524 mm or 1600 mm or 1668 mm track gauge systems, in case of a~~

 OTIF	Uniform Technical Prescription (UTP)		UTP LOC&PAS	
	LOCOMOTIVES AND PASSENGER ROLLING STOCK		Page 90 of 272	
Status: DRAFT	Version: 03	TECH-20041 Annex	Original: EN	Date: 20.10.2020

maximum speed higher than the limits specified in the clauses 4.2.6.2.1 to 4.2.6.2.5, the procedure for innovative solution shall apply ~~for which the corresponding requirements are an open point.~~

- (2) The passing of a train causes an unsteady airflow with varying pressures and flow velocities. These pressure and flow velocity transients have an effect on persons, objects and buildings at the trackside; they have also an effect on the rolling stock (e.g. aerodynamic load on vehicle structure, buffeting of equipment), and are to be taken into account in the design of rolling stock.
- (3) The combined effect of train speed and air speed causes an aerodynamic rolling moment that can affect the stability of rolling stock.

4.2.6.2.1 Slipstream effects on passengers on platforms ~~and on workers trackside~~ workers

- (1) Units of maximum design speed $v_{tr,max} > 160$ km/h, running in the open air at a reference speed $v_{tr,ref}$ ~~specified in table 4~~, shall not cause the air speed to exceed, at each measurement point defined in clause 4.2.2.1 and Table 5 of the specification referenced in Appendix J-1 index 108, the value $u_{95\%,max}$ as indicated in Table 5 of the specification referenced in Appendix J-1, index 108 ~~the value $u_{2\sigma}$ as indicated in the table 4 as measured at a height of 0.2 m and 1.4 m above top of rail at a distance of 3.0 m from the track centre, during the passage of the unit.~~
- (2) For units intended to be operated on the networks with track gauges of 1524 mm and 1668 mm, the corresponding values in Table 4 referring to the parameters of the specification referenced in Appendix J-1, index 108 shall be applied:

Table 4. Limit criteria

Track gauge (mm)	Maximum design speed $v_{tr,max}$ (km/h)	Measurement point		Trackside maximum permissible air speed, (limit values for $u_{2\sigma}$ (m/s))	Reference speed $v_{tr,ref}$ (km/h)
		Measurement performed at height above the top of rail	Measurement performed at a distance from the track centre		
1524	$160 < v_{tr,max} < 250$	0,2 m	<u>3,0 m</u>	22,50	Maximum design speed
		1,4 m	<u>3,0 m</u>	185,5	200 km/h or the maximum design speed, whichever is lower
1668	$160 < v_{tr,max} < 250$	<u>0,2 m</u>	<u>3,1 m</u>	<u>20</u>	<u>Maximum design speed</u>
		<u>1,4 m</u>	<u>3,1 m</u>	<u>15,5</u>	<u>200 km/h or the maximum design speed, whichever is lower</u>
	$250 \leq v_{tr,max}$	0.2 m	<u>3,1 m</u>	22	300 km/h or the maximum design speed, whichever is lower
		1,4 m	<u>3,1 m</u>	15,5	200 km/h

- ~~(2)~~(3) The train formation to be tested is specified for fixed/predefined formations and units assessed for use in general operation respectively in clauses 4.2.2.2 and 4.2.2.4 of the specification referenced in Appendix J-1, index 108. Single units fitted with a drivers cab shall be tested within a formation complying with the requirements set out in clause 4.2.2.3 of specification referenced in Appendix J-1, index 108. ~~below for different types of rolling stock:~~

 OTIF	Uniform Technical Prescription (UTP)		UTP LOC&PAS	
	LOCOMOTIVES AND PASSENGER ROLLING STOCK		Page 91 of 272	
Status: DRAFT	Version: 03	TECH-20041 Annex	Original: EN	Date: 20.10.2020

~~Unit assessed in fixed~~

~~The full length of the fixed formation.~~

~~In case of multiple unit operation at least two units coupled together shall be tested.~~

~~Units assessed in predefined formation~~

~~Train formation including the end vehicle and intermediate vehicles in a rake consisting of at least 100 m or the maximum predefined length if shorter than 100 m.~~

~~Unit assessed for use in general operation (train formation not defined at design stage):~~

- ~~• the unit shall be tested in a train formation consisting of a rake of at least 100 m of intermediate coaches;~~
- ~~• in the case of a locomotive or driving cab this vehicle shall be placed in the first and in the last position of the train formation;~~
- ~~• in the case of coaches (passenger carriages) the train formation shall include as a minimum a coach formed by the type of unit under assessment running in first and last positions of the rake of intermediate coaches.~~

~~Note: for coaches a conformity assessment is required only in case of new design that has an impact on the slipstream effect.~~

~~(3)~~(4) The conformity assessment procedure is described in clause 6.2.3.13 of this

UTP.

~~TSI.~~

4.2.6.2.2 Head pressure pulse

(1) The passing of two trains generates an aerodynamic load on each of the two trains. The requirement on head pressure pulse in open air allows ~~defining~~ a limit aerodynamic load induced by the rolling stock in open air to be defined assuming a distance between track centres ~~distance~~ for the track where the train is intended to be operated.

The ~~track centre~~ distance between track centres depends on the speed and the gauge of the line; ~~minimum~~ Minimum values of a distance between track centres ~~distance~~ depending on speed and gauge

are defined as per the UTP INF. ~~are characteristics of the infrastructure.~~ | are defined as per the INF TSI.

(2) Units with a maximum design speed higher than 160 km/h running in the open air at their reference speed $v_{tr,ref}$ on 1435 mm track gauge shall not cause the maximum peak-to-peak pressure to exceed the maximum permissible pressure change defined in Table 2 of the specification referenced in Appendix J-1, index 109 assessed over the measurement positions defined in point 4.1.2 of the specification referenced in Appendix J-1, index 109. ~~and lower than 250 km/h, running in the open air at their maximum speed shall not cause the maximum peak to peak pressure of changes to exceed a value of 800 Pa as assessed over the range of height between 1,5 m and 3,0 m above the top of rail, and at a distance of 2,5 m from the track centre, during the passage of the head.~~

(3) For units intended to be operated on the networks with track gauges of 1524 mm and 1668 mm, the corresponding values in Table 4a referring to the parameters of the specification referenced in Appendix J-1, index 109 shall be applied. ~~Units with a maximum design speed higher or equal to 250 km/h running in the open air at the given reference speed 250 km/h shall not cause the maximum peak to peak pressure~~

 OTIF	Uniform Technical Prescription (UTP)		UTP LOC&PAS	
	LOCOMOTIVES AND PASSENGER ROLLING STOCK		Page 92 of 272	
Status: DRAFT	Version: 03	TECH-20041 Annex	Original: EN	Date: 20.10.2020

~~of changes to exceed a value of 800 Pa as assessed over the range of height between 1,5 m and 3,0 m above the top of rail, and at a distance of 2,5 m from the track centre, during the passage of the head.~~

Table 4a. Limit criteria

Track gauge	Maximum design speed $v_{tr,max}$ (km/h)	Measurement point		Permissible pressure change, ($\Delta p_{95\%max}$)	Reference speed $v_{tr,ref}$ (km/h)
		Measurement performed at height above the top of rail	Measurement performed at a distance from the track centre		
1524 mm	$160 < v_{tr,max} < 250$	between 1,5 m and 3,0 m	2,5 m	1600 Pa	Maximum design speed
1668 mm	$160 < v_{tr,max} < 250$	between 1,5 m and 3,0 m	2,6 m	800 Pa	Maximum design speed
	$250 \leq v_{tr,max}$	between 1,5 m and 3,0 m	2,6 m	800 Pa	250 km/h

(4) The formation to be verified by a test is specified below for different types of rolling stock:

- Unit assessed in fixed or predefined formation:
 - A single unit of the fixed formation or any configuration of the pre-defined formation.
- Unit assessed for use in general operation (train formation not defined at design stage):
 - Unit fitted with a drivers cab shall be assessed alone.
 - Other units: Requirement not applicable.

(5) The conformity assessment procedure is described in clause 6.2.3.14 of this

UTP.

~~TSI~~

4.2.6.2.3 Maximum pressure variations in tunnels

(1) Units of maximum design speed higher than or equal to 200 km/h shall be aerodynamically designed so that for a given combination (reference case) of train speed and tunnel cross section in case of a solo run in a simple, non-inclined tube-like tunnel (without any shafts etc.) a requirement for the characteristic pressure variation shall be met. The requirements are given in the Table 5.

Table 5. Requirements for units in a solo-run in a non-inclined tube-like tunnel

	Reference case		Criteria for the reference case		
	v_{tr}	A_{tu}	Δp_N	$\Delta p_N + \Delta p_{Fr}$	$\Delta p_N + \Delta p_{Fr} + \Delta p_T$
< 250 km/h	200 km/h	53,6 m ²	≤ 1750 Pa	≤ 3000 Pa	≤ 3700 Pa
≥ 250 km/h	250 km/h	63,0 m ²	≤ 1600 Pa	≤ 3000 Pa	≤ 4100 Pa

Where v_{tr} is the train speed and A_{tu} is the tunnel cross sectional area.

(2) The formation to be verified by a test is specified below for different types of rolling stock:

 OTIF	Uniform Technical Prescription (UTP)		UTP LOC&PAS	
	LOCOMOTIVES AND PASSENGER ROLLING STOCK		Page 93 of 272	
Status: DRAFT	Version: 03	TECH-20041 Annex	Original: EN	Date: 20.10.2020

- Unit assessed in fixed or predefined formation: assessment shall be made with the maximum length of the train (including multiple operations of trainsets).
- Unit assessed for general operation (train formation not defined at design stage) and fitted with a driver's cab: two arbitrary train compositions of minimum length 150 m; one with the unit in leading position and one with the unit at the end.
- Other units (coaches for general operation): on the basis of one train formation of at least 400 m.

(3) The conformity assessment procedure, including definition of parameters mentioned above is described in clause 6.2.3.15 of this

UTP.

~~TSI~~

4.2.6.2.4 Cross wind

- (1) This requirement applies to units of maximum design speed higher than 140 km/h.
- (2) For units of maximum design speed higher than 140 km/h and lower than 250 km/h the characteristic wind curve (CWC) of the most sensitive vehicle shall be determined in accordance with the specification referenced in Appendix J-1, index 37 and subsequently recorded in the technical file as per clause 4.2.12.
- (3) For units of maximum design speed equal to or higher than 250 km/h the crosswind effects shall be evaluated according to one of the following methods:
 - (1) determined and complying with the specification of the EU Commission Decision 2008/232/EC¹³ clause 4.2.6.3, or
 - (2) determined by the assessment method of the specification referenced in Appendix J-1, index 37. The resulting characteristic wind curve of the most sensitive vehicle of the unit under assessment shall be recorded in the technical documentation as per clause 4.2.12.

4.2.6.2.5 Aerodynamic effect on ballasted tracks

- (1) This requirement applies to units of maximum design speed higher than ~~or equal to 192~~250 km/h.
- (2) The requirement on the aerodynamic effect of trains on ballasted tracks, in order to limit risks induced by the projection of ballast (ballast pick up), is an open point.

4.2.7 External lights & visible and audible warning devices

4.2.7.1 External lights

- (1) The colour green shall not be used for external light or illumination; this requirement is made to prevent any confusion with fixed signals.
- (2) This requirement is not applicable to lights with luminous ~~of~~ intensity not higher than 100 cd/m² that are included in push buttons for the command of passenger doors (not continuously lit).

¹³ Commission Decision 2008/232/EC of 21 February 2008 concerning a technical specification for interoperability relating to the 'rolling stock' sub-system of the trans-European high-speed rail system (notified under document C(2008) 648) (OJ L 84, 26.3.2008, p.132-392)

 OTIF	Uniform Technical Prescription (UTP)		UTP LOC&PAS	
	LOCOMOTIVES AND PASSENGER ROLLING STOCK		Page 94 of 272	
Status: DRAFT	Version: 03	TECH-20041 Annex	Original: EN	Date: 20.10.2020

4.2.7.1.1 Head lights

- (1) This clause applies to units fitted with a driver's cab.
- (2) Two white headlamps shall be provided at the front end of the train in order to give visibility for the train driver.
- (3) These head lamps shall be located:
 - at the same height above the rail level, with their centres between 1500 and 2000 mm above the rail level.
 - symmetrically compared to the centre-line of rails, and with a distance between their centres not less than 1000 mm.
- (4) The colour of head lamps shall be in accordance with the values specified in the specification referenced in Appendix J-1, index 38, clause 5.3.3, table 1.
- (5) Headlamps shall provide 2 luminous intensity levels: “dimmed headlamp” and “full-beam headlamp”.
For “dimmed headlamp”, the luminous intensity of headlamps measured along the optical axis of the head lamp shall be in accordance with the values specified in the specification referenced in Appendix J-1, index 38, clause 5.3.4, table 2, first line.
For “full-beam headlamp”, the minimum luminous intensity of headlamps measured along the optical axis of the lamp shall be in accordance with the values specified in the specification referenced in Appendix J-1, index 38, clause 5.3.4, table 2, first line.
- (6) The installation of head lamps on the unit shall provide a means of alignment adjustment of their optical axis when installed on the unit according to the specification referenced in Annex J-1, index 38, clause 5.3.5, to be used during maintenance activities.
- (7) Additional head lamps may be provided (e.g. upper head lamps). These additional head lamps shall fulfil the requirement on the colour of head lamps specified above in this clause.

Note: additional head lamps are not mandatory; their use at operational level may be subject to restrictions.

4.2.7.1.2 Marker lights

- (1) This clause applies to units fitted with a driver's cab.
- (2) Three white marker lamps shall be provided at the front end of the train in order to make the train visible.
- (3) Two lower marker lamps shall be located:
 - at the same height above the rail level, with their centres between 1500 and 2000 mm above the rail level.
 - symmetrically compared to the centre-line of rails, and with a distance between their centres not less than 1000 mm.
- (4) The third marker lamp shall be located centrally above the two lower lamps, with a vertical separation between their centers equal to or greater than 600 mm.

 OTIF	Uniform Technical Prescription (UTP)		UTP LOC&PAS	
	LOCOMOTIVES AND PASSENGER ROLLING STOCK		Page 95 of 272	
Status: DRAFT	Version: 03	TECH-20041 Annex	Original: EN	Date: 20.10.2020

- (5) It is permitted to use the same component for both head lights and marker lights.
- (6) The colour of marker lamps shall be in accordance with the values specified in the specification referenced in Appendix J-1, index 39, clause 5.4.3.1, table 4.
- (7) The spectral radiation distribution of light from the marker lamps shall be in accordance with the values specified in the specification referenced in Appendix J-1, index 39, clause 5.4.3.2.
- (8) The luminous intensity of marker lamps shall be in accordance with the specification referenced in Appendix J-1, index 39, clause 5.4.4, table 6.

4.2.7.1.3 Tail lights

- (1) Two red tail lamps shall be provided at the rear end of units intended to be operated at the rear end of the train in order to make the train visible.
- (2) For units without driver's cab assessed for general operation, the lamps may be portable lamps; in that case, the type of portable lamp to be used shall be in accordance with the Appendix E of the "freight wagons"

UTP;

~~TSI~~

the function shall be verified by design examination and type test at component level (interoperability constituent "portable tail lamp"), but it is not required to provide the portable lamps.

- (3) The tail lamps shall be located:
 - at the same height above the rail level, with their centres between 1 500 and 2000 mm above the rail level.
 - symmetrically compared to the centre-line of rails, and with a distance between their centres not less than 1000 mm.
- (4) The colour of tail lamps shall be in accordance with the specification referenced in Appendix J-1, index 40, clause 5.5.3, table 7 (values).
- (5) The luminous intensity of tail lamps shall in accordance with the specification referenced in Appendix J-1, index 40, clause 5.5.4, table 8 (value).

4.2.7.1.4 Lamp controls

- (1) This clause applies to units fitted with a driver's cab.
- (2) It shall be possible for the driver to control:
 - the head, marker lamps of the unit from the normal driving position;
 - the tail lamps of the unit from the cab.

This control may use independent command or combination of commands.

~~Note: where it is intended to use lights to inform of an emergency situation~~

 OTIF	Uniform Technical Prescription (UTP)		UTP LOC&PAS	
	LOCOMOTIVES AND PASSENGER ROLLING STOCK		Page 96 of 272	
Status: DRAFT	Version: 03	TECH-20041 Annex	Original: EN	Date: 20.10.2020

Note: where it is intended to use lights to inform of an emergency situation (operating rule, see OPE TSI), this should be done only by means of head lamps in flashing/blinking mode.

~~this should be done only by means of head lamps in flashing/blinking mode.~~

4.2.7.2 Horn (audible warning device)

4.2.7.2.1 General

- (1) This clause applies to units fitted with a driving cab.
- (2) Trains shall be fitted with warning horns in order to make the train audible.
- (3) The notes of the audible warning horns are intended to be recognisable as being from a train and not be similar to warning devices used in road transport or as factory or other common warning device. The operation of the warning horns shall emit at least one of the following separate warning sounds below:
 - Sounding 1: the fundamental frequency of the separately sounded note shall be 660 Hz \pm 30 Hz (high note).
 - Sounding 2: the fundamental frequency of the separately sounded note shall be 370 Hz \pm 20 Hz (low note).
- (4) In case additional warning sounds to one of the above (separate or combined) are provided on a voluntary basis, their sound pressure level shall not be higher than values specified below in the clause 4.2.7.2.2.

Note to points (1) – (4): their use at operational level may be subject to restrictions.

4.2.7.2.2 Warning horn sound pressure levels

- (1) The C weighted sound pressure level produced by each horn sounded separately (or in a group if designed to sound simultaneously as a chord) when integrated on the unit shall be as defined in the specification referenced in Appendix J-1, index 41.
- (2) The conformity assessment procedure is specified in clause 6.2.3.17.

4.2.7.2.3 Protection

- (1) Warning horns and their control systems shall be designed or protected, so far as is practicable, to maintain their function when impacted by airborne objects such as debris, dust, snow, hail or birds.

4.2.7.2.4 Horn control

- (1) It shall be possible for the driver to sound the audible warning device from all driving positions specified in clause 4.2.9 of this

UTP.

~~TSI.~~

 OTIF	Uniform Technical Prescription (UTP)		UTP LOC&PAS	
	LOCOMOTIVES AND PASSENGER ROLLING STOCK		Page 97 of 272	
Status: DRAFT	Version: 03	TECH-20041 Annex	Original: EN	Date: 20.10.2020

4.2.8 Traction and electrical equipment

4.2.8.1 Traction performance

4.2.8.1.1 General

- (1) The purpose of the train traction system is to ensure that the train is able to be operated at various speeds up to its maximum service speed. The primary factors that influence traction performances are traction power, train composition and mass, adhesion, track gradient and train running resistance.
- (2) Unit performance for units fitted with traction equipment, and operated in various train formations shall be defined so that the overall traction performance of the train can be derived.
- (3) The traction performance is characterised by the maximum service speed and by the traction force profile [force at wheel rim =F (speed)].
- (4) The unit is characterised by its running resistance and its mass.
- (5) The maximum service speed, the traction force profile and the running resistance are the unit contributions necessary to define a timetable allowing a train to slot into the overall traffic pattern on a given line, and are part of the technical documentation related to the unit described in clause 4.2.12.2 of this

UTP.

~~TSI.~~

4.2.8.1.2 Requirements on performance

- (1) This clause applies to units fitted with traction equipment.
- (2) Unit traction force profiles [force at wheel rim = F(speed)] shall be determined by calculation; the unit running resistance shall be determined by a calculation for the load case “design mass under normal payload”, as defined in clause 4.2.2.10.
- (3) Unit traction force profiles and running resistance shall be recorded in the technical documentation (see clause 4.2.12.2).
- (4) The design maximum speed shall be defined from the data above for the load case “design mass under normal payload” on a level track; design maximum speed higher than 60 km/h shall be a multiple of 5 km/h.
- (5) For units assessed in fixed or predefined formation, at the maximum service speed and on a level track, the unit shall still be capable of an acceleration of at least 0.05 m/s² for the load case “design mass under normal payload”. This requirement may be verified by calculation or by testing (acceleration measurement) and applies for maximum design speed up to 350 km/h.
- (6) Requirements regarding the traction cut-off required in case of braking are defined in the clause 4.2.4 of this

UTP.

~~TSI.~~

- (7) Requirements regarding availability of the traction function in case of fire on board are defined in the clause 4.2.10.4.4.

 OTIF	Uniform Technical Prescription (UTP)		UTP LOC&PAS	
	LOCOMOTIVES AND PASSENGER ROLLING STOCK		Page 98 of 272	
Status: DRAFT	Version: 03	TECH-20041 Annex	Original: EN	Date: 20.10.2020

Additional requirement for units assessed in fixed or predefined formation of maximum design speed higher than or equal to 250 km/h:

- (8) The mean acceleration on a level track, for the load case “design mass under normal payload”, shall be of at least of:
- 0.40 m/s² from 0 to 40 km/h
 - 0.32 m/s² from 0 to 120 km/h
 - 0.17 m/s² from 0 to 160 km/h.
- This requirement may be verified by calculation only or by testing (acceleration measurement) combined with calculation.
- (9) The design of the traction system shall assume a calculated wheel/rail adhesion not higher than:
- 0.30 at start up and very low speed
 - 0.275 at 100 km/h
 - 0.19 at 200 km/h
 - 0.10 at 300 km/h.
- (10) A single failure of power equipment affecting the traction capability shall not deprive the unit of more than 50 % of its traction force.

4.2.8.2 Power supply

4.2.8.2.1 General

- (1) Requirements applicable to rolling stock, and which interface with the Energy subsystem are dealt with in this clause; therefore, this clause 4.2.8.2 applies to electric units.

- (2) The

requirements in this UTP take into account compatibility with ENE TSI specifies

the following power systems: AC 25 kV 50 Hz system, AC 15 kV 16.7 Hz system, DC 3 kV system and 1.5 kV system. As a consequence, requirements defined below are related to these 4 systems only, and references to standards are valid for these 4 systems only.

4.2.8.2.2 Operation within range of voltages and frequencies

- (1) Electric units shall be able to operate within the range of at least one of the systems “voltage and frequency” defined

in point 4.2.8.2.1 - 2) of this UTP. The values and limits of the voltage and frequency at the terminals of the substation and at the pantograph are presumed to comply with EN 50163:2004, clause 4. in the ENE TSI, clause 4.2.3.

- (2) The actual value of the line voltage shall be available in the driver cab in driving configuration.

 OTIF	Uniform Technical Prescription (UTP)		UTP LOC&PAS	
	LOCOMOTIVES AND PASSENGER ROLLING STOCK		Page 99 of 272	
Status: DRAFT	Version: 03	TECH-20041 Annex	Original: EN	Date: 20.10.2020

- (3) The systems ‘voltage and frequency’ for which the rolling stock is designed shall be recorded in the technical documentation defined in clause 4.2.12.2 of this

UTP.

~~TSI~~

4.2.8.2.3 *Regenerative brake with energy to the overhead contact line*

- (1) Electric units which return electrical energy to the overhead contact line in regenerative braking mode shall comply with the specification referenced in Appendix J-1, index 42.
- (2) It shall be possible to control the use of the regenerative brake.

4.2.8.2.4 *Maximum power and current from the overhead contact line*

- (1) Electric units with power higher than 2 MW (including the declared fixed and predefined formations) shall be equipped with power or current limitation function.
- (2) Electric units shall be equipped with automatic regulation of the current within abnormal operation condition regarding voltage; this regulation shall allow limiting the current to the ‘maximum current against voltage’ specified in the specification referenced in Appendix J-1, index 43.

Note: a less restrictive limitation (lower value of coefficient ‘a’) may be used at operating level on a particular network or line if agreed by the Infrastructure Manager.

- (3) The maximum current assessed here above (rated current) shall be recorded in the technical documentation defined in clause 4.2.12.2 of this

UTP.

~~TSI~~

4.2.8.2.5 *Maximum current at standstill for DC systems*

- (1) For DC systems, the maximum current at standstill per pantograph shall be calculated and verified by measurement.

- (2) For the verification of compatibility between a unit and the overhead contact line of DC systems, this UTP assumes, without prejudice to specific cases, that the overhead contact line:

- is designed to sustain 300 A (for a 1.5 kV supply system) and 200 A (for a 3 kV supply system), per pantograph when the train is at standstill, and
- the current capacity at standstill is achieved for the test value of static contact force given in table 4 of clause 7.2 of EN 50367:2012, and
- the OCL is designed taking into account the temperature limits in accordance with EN 50119:2009 clause 5.1.2.

Limit values are specified in clause 4.2.5 of the ENE TSI.

 OTIF	Uniform Technical Prescription (UTP)		UTP LOC&PAS	
	LOCOMOTIVES AND PASSENGER ROLLING STOCK		Page 100 of 272	
Status: DRAFT	Version: 03	TECH-20041 Annex	Original: EN	Date: 20.10.2020

- (3) The value measured and measurement conditions regarding the material of the contact wire shall be recorded in the technical documentation defined in clause 4.2.12.2 of this

UTP.

~~TSI~~

4.2.8.2.6 Power factor

- (1) The power factor design data of the train (including multiple operation of several units as defined in clause 2.2 of this

UTP)

~~TSI~~

shall be subject to a calculation to verify acceptance criteria set out in the specification referenced in Appendix J-1, index 44.

4.2.8.2.7 System energy disturbances for ac systems

- (1) An Electric unit shall not cause unacceptable overvoltage and other phenomena described in the specification referenced in Appendix J-1, index 45, clause 10.1 (harmonics and dynamic effects) on the overhead contact line.
- (2) A compatibility study shall be done in accordance with the methodology defined in the specification referenced in Appendix J-1, index 45, clause 10.3. The steps and hypothesis described in table 5 of the same specification have to be defined by the applicant (column 3 “Concerned party” not applicable), with input data presented as in Annex D of the same specification; the acceptance criteria shall be as defined in clause 10.4 the same specification.
- (3) All hypothesis and data considered for this compatibility study shall be recorded in the technical documentation (see clause 4.2.12.2).

4.2.8.2.8 On-board energy measurement system

4.2.8.2.8.1 General

- (1) The on-board energy measurement system (EMS) is the system for measurement of all active and reactive electric energy taken from or returned (during regenerative braking) to the overhead contact line (OCL) by the electric unit.

Fitting an EMS system is mandatory for vehicles with an area of use including one or more Contracting States that apply European Union law.

If an EMS system is fitted it shall comply with the provisions of this UTP.

- (2) The EMS shall include at least the following functions: Energy measurement function (EMF) as set out in clause 4.2.8.2.8.2, data handling system (DHS) as set out in clause 4.2.8.2.8.3. ~~On-board energy measurement systems shall comply with requirements of the Appendix D of this~~

~~UTP.~~

~~TSI~~

- (3) A suitable communication system will send the compiled energy billing data sets (CEBD) to an on-ground data collecting system (DCS). The interface protocols and transferred data format between EMS

 OTIF	Uniform Technical Prescription (UTP)		UTP LOC&PAS	
	LOCOMOTIVES AND PASSENGER ROLLING STOCK		Page 101 of 272	
Status: DRAFT	Version: 03	TECH-20041 Annex	Original: EN	Date: 20.10.2020

~~and DCS shall fulfil the requirements set out in point 4.2.8.2.8.4. This system is suitable for billing purposes; the data provided by it shall be accepted for billing in all Member States.~~

- (4) ~~This system is suitable for billing purposes; the data sets defined in point 4.2.8.2.8.3(4) provided by this system shall be accepted for billing in all Contracting States. The fitment of an on-board energy measurement system, and of its on-board location function shall be recorded in the technical documentation described in clause 4.2.12.2 of this~~

~~UTP;~~

~~TSI;~~

~~the description of on-board to ground communication shall be part of the documentation.~~

- (5) ~~The EMS rated current and voltage shall be matched to the electric unit rated current and voltage; it shall continue to function correctly when changing between several traction energy supply systems. The maintenance documentation described in clause 4.2.12.3 of this~~

~~UTP.~~

~~TSI.~~

- (6) ~~Data stored in the EMS shall be protected against loss of the power supply and the EMS shall be protected from non-authorised access. shall include any periodic verification procedure, in order to ensure the required accuracy level of the on-board energy measurement system during its lifetime.~~

- (7) ~~An on-board location function providing location data originated from an external source to the DHS shall be provided in networks where such function is necessary for billing purposes only. In any case, the EMS system shall be able to accommodate a compatible location function. If the location function is provided, it shall fulfil the requirements set out in specification referenced in Appendix J-1, index 116.~~

- (8) ~~The fitment of an EMS, its on-board location function, the description of on-board to ground communication and the metrological control including the accuracy class of the EMF shall be recorded in the technical documentation described in clause 4.2.12.2 of this UTP.~~

- (9) ~~The maintenance documentation described in clause 4.2.12.3 of this UTP shall include any periodic verification procedure to ensure the required accuracy level of the EMS during its lifetime.~~

4.2.8.2.8.2 Energy measurement function (EMF)

- (1) ~~The EMF shall ensure the measurement of the voltage and current, calculation of the energy and production of energy data.~~

- (2) ~~The energy data produced by EMF shall have a time reference period of 5 minutes defined by the Universal Time Coordinated (UTC) clock time at the end of each time reference period; originating from the time stamp 00:00:00. It is permitted to use a shorter measuring period if the data can be aggregated on-board into 5 minutes time reference period.~~

- (3) ~~The accuracy of EMF for active energy measurement shall comply with clauses 4.2.3.1 to 4.2.3.4 of the specification referenced in Appendix J-1, index 117.~~

- (4) ~~Each device containing one or more functions of EMF shall indicate: metrological control, and its accuracy class, according to the class designations specified in the specification referenced in clauses 4.3.3.4, 4.3.4.3 and 4.4.4.2 of the specification referenced in Appendix J-1, index 117.~~

- (5) ~~The conformity assessment of the accuracy is set out in clause 6.2.3.19a.~~

 OTIF	Uniform Technical Prescription (UTP)		UTP LOC&PAS	
	LOCOMOTIVES AND PASSENGER ROLLING STOCK		Page 102 of 272	
Status: DRAFT	Version: 03	TECH-20041 Annex	Original: EN	Date: 20.10.2020

4.2.8.2.8.3 Data handling system (DHS)

- (1) The DHS shall ensure the production of compiled energy billing data sets for energy billing purposes, by merging data from the EMF with time data and, when required, geographical position, and storing it ready to be sent to an on-ground data collecting system (DCS) by a communication system.
- (2) The DHS shall compile the data without corrupting them and shall incorporate data storage with a memory capacity sufficient to store the compiled data of at least 60 days continuous operation. The time reference used shall be the same as in the EMF.
- (3) The DHS shall have a capability to be interrogated locally on-board for audit and data recovery purposes.
- (4) The DHS shall produce compiled energy billing data sets, (CEBD), by merging the following data for each time reference period:
 - unique EMS consumption point identification (CPID) as defined in the specification referenced in Appendix J-1, index 118,
 - end time of each period, defined as year, month, day, hour, minute and second,
 - location data at the end of each period,
 - consumed/regenerated active and reactive (if appropriate) energy in each period, in units of watt-hour (active energy) and var-hour (reactive energy) or their decimal-multiples.
- (5) The conformity assessment of compilation and handling of data produced by DHS is set out in clause 6.2.3.19a.

4.2.8.2.8.4 Interface protocols and transferred data format between EMS and DCS

The data exchange between EMS and DCS shall fulfil the following requirements:

- The application services (service layer) of the EMS shall comply with clause 4.3.3.1 of the specification referenced in Appendix J-1, index 119.
- User access rights for these application services shall comply with clause 4.3.3.3 of the specification referenced in Appendix J-1, index 119.
- The structure (data layer) for these application services shall comply with the XML schema as defined in clause 4.3.4 of the specification referenced in Appendix J-1, index 119.
- The message mechanism (message layer) for supporting these application services shall comply with the methods and the XML schema in clause 4.3.5 of the specification referenced in Appendix J- 1, index 119.
- The application protocols for supporting the message mechanism shall comply with clause 4.3.6 of the specification referenced in Appendix J-1, index 119.
- The EMS shall use at least one of the communication architectures in clause 4.3.7 of the specification referenced in Appendix J-1, index 119.

 OTIF	Uniform Technical Prescription (UTP)		UTP LOC&PAS	
	LOCOMOTIVES AND PASSENGER ROLLING STOCK		Page 103 of 272	
Status: DRAFT	Version: 03	TECH-20041 Annex	Original: EN	Date: 20.10.2020

4.2.8.2.9 Requirements linked to pantograph

4.2.8.2.9.1 Working range in height of pantograph

4.2.8.2.9.1.1 Height of interaction with contact wires (RST level)

The installation of a pantograph on an Electric unit shall allow mechanical contact from at least one of the contact wires at heights between:

- 4800 mm and 6500 mm above rail level for tracks designed in accordance with the gauge GC.
- 4500 mm and 6500 mm above rail level for tracks designed in accordance with the gauge GA/GB.
- 5550 mm and 6800 mm above rail level for tracks designed in accordance with the gauge T (track gauge system 1520 mm)
- 5600 mm and 6600 mm above rail level designed in accordance with the gauge FIN1 (track gauge system 1524 mm).
- 3920 mm and 5700 mm above rail level for electric units designed to be operated on the 1500 V DC system in accordance with the IRL gauge (track gauge system 1600 mm).

Note: current collection is verified according to clauses 6.1.3.7 and 6.2.3.21 of this

UTP,

~~TSI~~

specifying heights of contact wire for tests; however, current collection at low speed is assumed to be possible from a contact wire at any of the heights specified above.

4.2.8.2.9.1.2 Working range in height of pantograph (IC level)

- (1) Pantographs shall have a working range of at least 2000 mm.
- (2) The characteristics to be verified shall be in accordance with the requirements of the specification referenced in Appendix J-1, index 46.

4.2.8.2.9.2 Pantograph head geometry (IC level)

- (1) For electric units designed to be operated on other track gauge systems than 1520 mm or 1600 mm system, at least one of the pantograph(s) to be installed shall have a head geometry type compliant with one of the two specifications given in the clauses 4.2.8.2.9.2.1 and 2 below.
- (2) For electric units designed to be operated solely on the 1520 mm system, at least one of the pantograph(s) to be installed shall have a head geometry type compliant with one of the three specifications given in the clauses 4.2.8.2.9.2.1, 2 and 3 below.
- 2a) For electric units designed to be operated solely on the 1600 mm system, at least one of the pantographs to be installed shall have a head geometry type compliant with the specifications given in the clauses 4.2.8.2.9.2.13a below.
- (3) The type(s) of pantograph head geometry that an electric unit is equipped with shall be recorded in the technical documentation defined in clause 4.2.12.2 of this

 OTIF	Uniform Technical Prescription (UTP)		UTP LOC&PAS	
	LOCOMOTIVES AND PASSENGER ROLLING STOCK		Page 104 of 272	
Status: DRAFT	Version: 03	TECH-20041 Annex	Original: EN	Date: 20.10.2020

UTP.

~~TSI~~

- (4) The width of pantograph head shall not exceed 0.65 meters.
- (5) Pantograph heads fitted with contact strips having independent suspensions shall be compliant with the specification referenced in Appendix J-1, index 47.
- (6) Contact between contact wire and pantograph head is permitted outside the contact strips and within the whole conducting range over limited line sections under adverse conditions, e.g. coincidence of vehicle swaying and high winds.

Conducting range and the minimum length of contact strip are specified below as part of the pantograph head geometry.

4.2.8.2.9.2.1 Pantograph head geometry type 1600 mm

- (1) The pantograph head geometry shall be as depicted in the specification referenced in Appendix J-1, index 48.

4.2.8.2.9.2.2 Pantograph head geometry type 1950 mm

- (1) The pantograph head geometry shall be as depicted in the specification referenced in Appendix J-1, index 49.
- (2) Insulated or non-insulated materials for the horns are both permitted.

4.2.8.2.9.2.3 Pantograph head geometry type 2000/2260 mm

- (1) The profile of the pantograph head shall be as depicted below:

Figure: Configuration and dimensions of contact skates

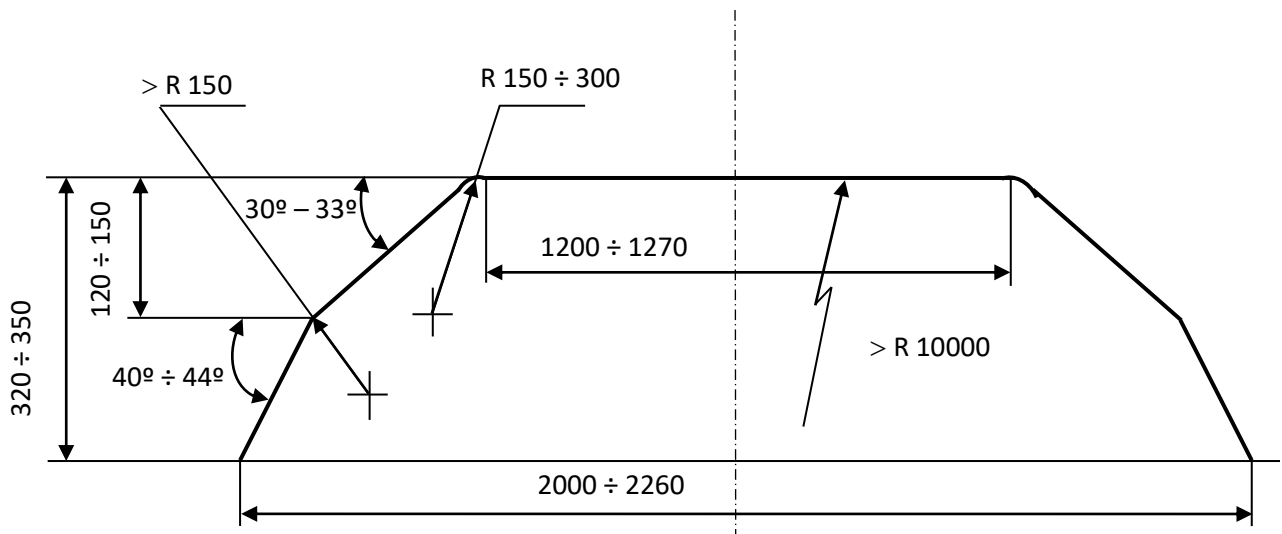

 OTIF	Uniform Technical Prescription (UTP)		UTP LOC&PAS	
	LOCOMOTIVES AND PASSENGER ROLLING STOCK		Page 105 of 272	
Status: DRAFT	Version: 03	TECH-20041 Annex	Original: EN	Date: 20.10.2020

4.2.8.2.9.3 *Pantograph head geometry type 1800 mm*

(1) The profile of the pantograph head shall be as depicted below:

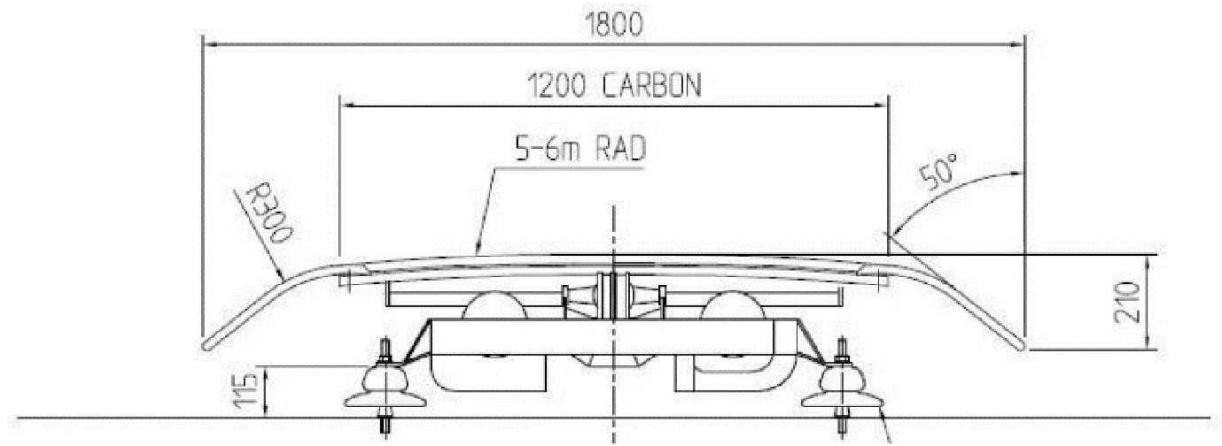

4.2.8.2.9.3a *Pantograph current capacity (IC level)*

- (1) Pantographs shall be designed for the rated current (as defined in clause 4.2.8.2.4) to be transmitted to the electric unit.
- (2) An analysis shall demonstrate that the pantograph is able to carry the rated current; this analysis shall include the verification of the requirements of the specification referenced in Appendix J-1, index 50.
- (3) Pantographs for DC systems shall be designed for the maximum current at standstill (as defined in clause 4.2.8.2.5 of this

UTP.

~~TSI~~

4.2.8.2.9.4 *Contact strip (IC level)*

- (1) Contact strips are the replaceable parts of the pantograph head, which are in direct contact with the contact wire.

4.2.8.2.9.4.1 *Contact strip geometry*

- (1) Contact strips shall be geometrically designed to be fitted to one of the pantograph head geometries specified in clause 4.2.8.2.9.2.

4.2.8.2.9.4.2 *Contact strip material*

- (1) Material used for the contact strips shall be mechanically and electrically compatible with the contact wire material

installed on the lines where the unit is intended to run, (as specified in clause 4.2.14 of the ENE TSI),

in order to ensure proper current collection and to avoid excessive abrasion of the surface of the contact wires, thereby minimising wear of both contact wires and contact strips.

 OTIF	Uniform Technical Prescription (UTP)		UTP LOC&PAS	
	LOCOMOTIVES AND PASSENGER ROLLING STOCK		Page 106 of 272	
Status: DRAFT	Version: 03	TECH-20041 Annex	Original: EN	Date: 20.10.2020

It is the responsibility of the Competent Authority to ensure that information about the contact strip material is provided to the applicant.

- (2) Plain carbon or impregnated carbon with additive material shall be permitted.

Where a metallic additive material is used, the metallic content of the carbon contact strips shall be copper or copper alloy and shall not exceed a content of 35 % by weight where used on AC lines and of 40 % where used on DC lines.

Pantographs assessed against this

UTP

~~TSI~~

shall be fitted with contact strips of a material mentioned above.

- (3) Additionally, contact strips of other material or higher percentage of metallic contents or impregnated carbon with clad copper are allowed (if permitted

on the lines where the unit is intended to run) | in the infrastructure register)

provided that:

- they are referenced in recognised standards, with mention of restrictions if any, or
- they have been subject to a test of suitability for use (see clause 6.1.3.8).

4.2.8.2.9.5 Pantograph static contact force (IC level)

- (1) The static contact force is the vertical contact force exerted upward by the pantograph head on the contact wire and caused by the pantograph-raising device, when the pantograph is raised and the vehicle is at standstill.
- (2) The static contact force exerted by the pantograph on the contact wire, as defined above, shall be adjustable within at least the following ranges (consistent with the area of use of the pantograph):
- 60 N to 90 N for AC supply systems,
 - 90 N to 120 N for DC 3 kV supply systems,
 - 70 N to 140 N for DC 1,5 kV supply systems,

4.2.8.2.9.6 Pantograph contact force and dynamic behaviour

- (1) The mean contact force F_m is the statistical mean value of the pantograph contact force, and is formed by the static and aerodynamic components of the contact force with dynamic correction.
- (2) The factors which influence the mean contact force are the pantograph itself, its position in the train consist, its vertical extension, and the rolling stock on which the pantograph is mounted.
- (3) Rolling stock and pantographs fitted on rolling stock are designed to exert a mean contact force F_m on the contact wire in a range specified

in the table below:

in clause 4.2.12 of the ENE TSI,



Requirement	$v \geq 250$ [km/h]	$250 > v > 160$ [km/h]	$v \leq 160$ [km/h]
Space for steady arm uplift	$2S_0$		
Mean contact force F_m	See points (1) to (4) below		
Standard deviation at maximum line speed σ_{max} (N)	$0,3 F_m$		
Percentage of arcing at maximum line speed, NQ (%) (minimum duration of arc 5 ms)	$\leq 0,2$	$\leq 0,1$ for AC systems $\leq 0,2$ for DC systems	$\leq 0,1$

- (1) The mean contact force F_m is the statistical mean value of the contact force. F_m is formed by the static, dynamic and aerodynamic components of the pantograph contact force.
- (2) The ranges of F_m for each of the power supply systems are defined in EN 50367:2012 Table 6.
- (3) The overhead contact lines shall be designed to be capable of sustaining the upper design limit of F_m given in EN 50367:2012 Table 6.
- (4) The curves apply to speeds up to 320 [km/h]. For speeds above 320 [km/h] procedures set out in point 6.1.3 shall apply.

S_0 is the calculated, simulated or measured uplift of the contact wire at a steady arm, generated in normal operating conditions with one or more pantographs with the upper limit of F_m at the maximum line speed. When the uplift of the steady arm is physically limited due to the overhead contact line design, it is permissible for the necessary space to be reduced to $1.5 S_0$ (refer to EN 50119:2009 clause 5.10.2).

Maximum force (F_{max}) is usually within the range of F_m plus three standard deviations σ_{max} ; higher values may occur at particular locations

 OTIF	Uniform Technical Prescription (UTP)		UTP LOC&PAS	
	LOCOMOTIVES AND PASSENGER ROLLING STOCK		Page 108 of 272	
Status: DRAFT	Version: 03	TECH-20041 Annex	Original: EN	Date: 20.10.2020

and are given in EN 50119:2009, Table 4 clause 5.2.5.2. For rigid components such as section insulators in overhead contact line systems, the contact force can increase up to a maximum of 350 N.

in order to ensure current collection quality without undue arcing and to limit wear and hazards to contact strips. Adjustment of the contact force is made when dynamic tests are performed.

- (4) The verification at interoperability constituent level shall validate the dynamic behaviour of the pantograph itself, and its capability to collect current from a

TSI compliant

overhead contact line; the conformity assessment procedure specified in clause 6.1.3.7.

- (5) The verification at rolling stock subsystem level (integration in a particular vehicle) shall allow to adjust the contact force, taking into account aerodynamic effects due to the rolling stock and the position of the pantograph in the unit or train fixed or predefined formation(s); the conformity assessment procedure specified in clause 6.2.3.20.

- (6) The

According to the ENE TSI, the

range of mean contact force F_m is not harmonised for overhead contact lines designed for speed higher than 320 km/h. Therefore electric units can only be assessed against this

UTP

TSI

regarding the dynamic behaviour of the pantograph up to the speed of 320 km/h.

For the speed range above 320 km/h up to the maximum speed (if higher than 320 km/h), the procedure for innovative solutions described in

this UTP

article 10 and Chapter 6 of this TSI

shall apply.

4.2.8.2.9.7 Arrangement of pantographs (RST level)

- (1) It is permissible for more than one pantograph to be simultaneously in contact with the overhead contact line equipment.
- (2) The number of pantographs and their spacing shall be designed taking into consideration the requirements of current collection performance, as defined in clause 4.2.8.2.9.6 above.
- (3) Where the spacing of 2 consecutive pantographs in fixed or pre-defined formations of the assessed unit is less than the spacing

as set out in the tables below:

shown in clause 4.2.13 of the ENE TSI,

Design speed (km/h)	AC Minimum distance (m)		
	A	B	C
$v \geq 250$	200		



160 < v < 250	200	85	35
120 < v ≤ 160	85	85	35
80 < v ≤ 120	20	15	15
v ≤ 80	8	8	8

Design speed (km/h)	3 kV DC Minimum distance (m)		
<i>Type</i>	<i>A</i>	<i>B</i>	<i>C</i>
v ≥ 250	200		
160 < v < 250	200	115	35
120 < v ≤ 160	20	20	20
80 < v ≤ 120	20	15	15
v ≤ 80	8	8	8

Design speed (km/h)	1,5 kV DC Minimum distance (m)		
<i>Type</i>	<i>A</i>	<i>B</i>	<i>C</i>
v ≥ 250	200	200	35
160 < v < 250	200	85	35
120 < v ≤ 160	85	35	20
80 < v ≤ 120	35	20	15
v ≤ 80	20	8	8

for the selected OCL design distance type, or where more than 2 pantographs are simultaneously in contact with the overhead contact line equipment, it shall be demonstrated by testing that the current collection quality as defined in clause 4.2.8.2.9.6 above is met for the poorest performing pantograph (identified by simulations to be performed prior to that test).

- (4) The OCL design distance type (A, B or C as defined in

point 3 of this section)

the clause 4.2.13 of the ENE TSI)

selected (and therefore used for the test) shall be recorded in the technical documentation (see clause 4.2.12.2).

4.2.8.2.9.8 *Running through phase or system separation sections (RST level)*

- (1) Trains shall be designed to be able to move from one power supply system and from one phase section to an adjacent one

without bridging either system or phase separation sections.

(as described in clauses 4.2.15 and 4.2.16 of the ENE TSI) without bridging either system or phase separation section.

For the verification of compatibility between a unit and the overhead contact line, this UTP assumes, without prejudice to specific cases, that the phase or system separation sections are as set out below:

Phase separation sections

General

 OTIF	Uniform Technical Prescription (UTP)		UTP LOC&PAS
	LOCOMOTIVES AND PASSENGER ROLLING STOCK		Page 110 of 272
Status: DRAFT	Version: 03	TECH-20041 Annex	Original: EN Date: 20.10.2020

The design of phase separation sections is deemed to ensure that trains can move from one section to an adjacent one without bridging the two phases. Power consumption of the train (traction, auxiliaries and no-load current of the transformer) is deemed to be brought to zero before entering the phase separation section. Adequate means (except for the short separation section) are deemed to be provided to allow a train that is stopped within the phase separation section to be restarted.

The overall length D of neutral sections is defined in EN 50367:2012, clause 4. For the calculation of D clearances in accordance with EN 50119:2009, clause 5.1.3 and an uplift of S_0 are deemed to be taken into account.

Lines with speed $v \geq 250$ [km/h]

Two types of designs of phase separation sections are deemed to be taken into account, either:

- i. a phase separation design where all the pantographs of the longest TSI compliant trains are within the neutral section. The overall length of the neutral section is deemed to be at least 402 m. For detailed requirements see EN 50367:2012, Annex A.1.2, or
- ii. a shorter phase separation with three insulated overlaps as shown in EN 50367:2012, Annex A.1.4. The overall length of the neutral section is deemed to be less than 142 m including clearances and tolerances.

Lines with speed $v < 250$ [km/h]

The design of separation sections is deemed to be in line with solutions as described in EN 50367:2012 Annex A.1. Where an alternative solution is used, the alternative is deemed to be at least as reliable.

System separation sections

General

The design of system separation sections is deemed to ensure that trains can move from one power supply system to an adjacent different power supply system without bridging the two systems. There are two methods for traversing system separation sections:

- (1) with pantograph raised and touching the contact wire,

 OTIF	Uniform Technical Prescription (UTP)		UTP LOC&PAS	
	LOCOMOTIVES AND PASSENGER ROLLING STOCK		Page 111 of 272	
Status: DRAFT	Version: 03	TECH-20041 Annex	Original: EN	Date: 20.10.2020

- (2) with pantograph lowered and not touching the contact wire.

The overall length D of neutral sections is deemed to be in line with EN 50367:2012, clause 4. For the calculation of D clearances in accordance with EN 50119:2009, clause 5.1.3 and an uplift of S_0 are deemed to be taken into account.

Pantographs raised

Power consumption of the train (traction, auxiliaries and no-load current of the transformer) shall be brought to zero before entering the system separation section. If system separation sections are traversed with pantographs raised to the contact wire, their functional design is deemed to be realised as follows:

- i. the geometry of different elements of the overhead contact line shall prevent pantographs short-circuiting or bridging both power systems,
- ii. provision shall be made in the energy subsystem to avoid bridging of both adjacent power supply systems should the opening of the on-board circuit breaker(s) fail,
- iii. variation in contact wire height along the entire separation section shall fulfil the requirements set in EN 50119:2009 clause 5.10.3.

Pantographs lowered

If a system separation section is traversed with pantographs lowered, it is deemed to be designed so as to avoid the electrical connection of the two power supply systems by an unintentionally raised pantograph.

- (2) Electric units designed for several power supply systems shall, when running through system separation sections, recognise automatically the voltage of the power supply system at the pantograph.
- (3) When running through phase or system separation sections, it shall be possible to bring the power consumption of the unit to zero.

~~As set out in Appendix K, it shall be the task of the infrastructure manager Competent Authority of each Contracting State~~ to make the relevant information about the infrastructure available to the applicant, such as

The infrastructure register gives information on

 OTIF	Uniform Technical Prescription (UTP)		UTP LOC&PAS	
	LOCOMOTIVES AND PASSENGER ROLLING STOCK		Page 112 of 272	
Status: DRAFT	Version: 03	TECH-20041 Annex	Original: EN	Date: 20.10.2020

the permitted pantographs position: lowered or raised (with permitted pantograph arrangements) when running through systems or phase separation sections.

- (4) Electric units of maximum design speed higher than or equal to 250 km/h shall be fitted with an on-board TCMS (train control and monitoring system) able to receive from the ground the information related to the location of the separation section, and the subsequent commands to the control of the pantograph and main circuit breaker shall be triggered automatically by the TCMS of the unit, without intervention of the driver.
- (5) Units intended to operate on lines that are fitted with the ETCS track side system for control-command and signalling shall be fitted with an on-board TCMS (train control and monitoring system) able to receive from the ETCS system the information related to the location of the separation section

with reference to Appendix J-2, index 3 of this UTP), as described in Annex A Index 7 of CCS TSI;

for units of maximum design speed lower than 250 km/h, the subsequent commands are not required to be automatic, but information on section separation provided by ETCS shall be displayed on-board for the intervention of the driver.

4.2.8.2.9.9 *Insulation of pantograph from the vehicle (RST level)*

- (1) The pantographs shall be assembled on an electric unit in a way that ensures the current path from collector head to vehicle equipment is insulated. The insulation shall be adequate for all system voltages the unit is designed for.

4.2.8.2.9.10 *Pantograph lowering (RST level)*

- (1) Electric units shall be designed to lower the pantograph in a period meeting the requirements of the specification referenced in Appendix J-1, index 51, clause 4.7 (3 seconds) and to the dynamic insulating distance according to the specification referenced in Appendix J-1, index 52 either by initiation by the driver or by a train control function (including CCS functions).
- (2) The pantograph shall lower to the stowed position in less than 10 seconds.
When lowering the pantograph, the main circuit breaker shall previously be opened automatically.
- (3) If an electric unit is equipped with an automatic dropping device (ADD) that lowers the pantograph in case of a collector head failure, the ADD shall meet the requirements of the specification referenced in Appendix J-1, index 51, clause 4.8.
- (4) Electric units of maximum design speed higher than 160 km/h shall be equipped with an ADD.
- (5) Electric units that require more than one pantograph raised in operation and of maximum design speed higher than 120 km/h shall be equipped with an ADD.
- (6) Other electric units are permitted to be equipped with an ADD.

4.2.8.2.10 *Electrical protection of the train*

- (1) Electric units shall be protected against internal short – circuits (from inside the unit).

 OTIF	Uniform Technical Prescription (UTP)		UTP LOC&PAS	
	LOCOMOTIVES AND PASSENGER ROLLING STOCK		Page 113 of 272	
Status: DRAFT	Version: 03	TECH-20041 Annex	Original: EN	Date: 20.10.2020

- (2) The location of the main circuit breaker shall be such as to protect the on-board high voltage circuits, including any high voltage connections between vehicles. The pantograph, the main circuit breaker, and the high voltage connection between them shall be located on the same vehicle.
- (3) Electric units shall protect themselves against short overvoltages, temporary overvoltages and maximum fault current. To meet this requirement, electrical protection coordination design of the unit shall comply with the requirements defined in the specification referenced in Appendix J-1, index 53.

4.2.8.3 Diesel and other thermal traction system

- (1) Diesel engines are to comply with the Union legislation concerning exhaust (composition, limit values).

4.2.8.4 Protection against electrical hazards

- (1) Rolling stock and its electrically live components shall be designed such that direct or indirect contact with train staff and passenger is prevented, both in normal cases and in cases of equipment failure. Provisions described in the specification referenced in Appendix J-1, index 54 shall be applied in order to meet this requirement.

4.2.9 Driver's Cab and driver-machine interface

- (1) The requirements specified in this clause apply to units fitted with a driver's cab.

4.2.9.1 Driver's Cab

4.2.9.1.1 General

- (1) The driver's cabs shall be designed to permit operation by a single driver.
- (2) The maximum noise level allowed in the cab is specified in the

UTP NOI.

~~NOI-TSI.~~

4.2.9.1.2 Access and egress

4.2.9.1.2.1 Access and egress in operating conditions

- (1) The driver's cab shall be accessible from both sides of the train from 200 mm below top of rail.
- (2) It is permissible for this access to be either directly from the exterior, using a cab external door, or through the area at the rear of the cab. In the latter case, requirements defined in this clause shall apply to the external accesses used for access to the cab on either side of the vehicle.
- (3) The means for the train crew to access in and to egress out of the cab, such as footsteps, handrails or opening handles, shall allow safe and easy usage by being of dimensions (pitch, width, spacing, shape) to be assessed by reference to recognised standards; they shall be designed with consideration of ergonomic criteria in relation with their use. Footsteps shall have no sharp edges causing obstacles for the shoes of the train crew.
- (4) Rolling stock with external walkways shall be equipped with handrails and foot bars (kicking strips) for driver safety when accessing the cab.

 OTIF	Uniform Technical Prescription (UTP)		UTP LOC&PAS	
	LOCOMOTIVES AND PASSENGER ROLLING STOCK		Page 114 of 272	
Status: DRAFT	Version: 03	TECH-20041 Annex	Original: EN	Date: 20.10.2020

- (5) Driver's cab external doors shall open in such a way that they remain within the intended reference profile (see clause 4.2.3.1 of this UTP) ~~TSD~~ when opened (the unit being at standstill).
- (6) Driver's cab external doors shall have a minimum clearance of 1675 x 500 mm when accessible by foot-steps, or of 1750 x 500 mm when accessible on floor level.
- (7) Interior doors used by the train crew to access the cab shall have a minimum clearance of 1700 x 430 mm.
- (8) For both driver's cab external doors and internal doors, in case they are positioned perpendicular to and against the side of the vehicle, it is allowed to have the clearance width in the upper part reduced (angle on the top-outer side) due to the gauge of the vehicle; this reduction shall be strictly limited to the gauge constraint in the upper part and shall not lead to a clearance width on top side of the door lower than 280 mm.
- (9) The driver's cab and its access shall be designed so that the train crew is able to prevent the cab being accessed by non-authorized persons, whether the cab is occupied or not, and so that a cab occupant is able to go outside of a cab without having to use any tool or key.
- (10) Access to the driver's cab shall be possible without any energy supply available on board. Cab external doors shall not open unintentionally.

4.2.9.1.2.2 *Driver's cab emergency exit*

- (1) In an emergency situation, evacuation of the train crew from the driver's cab and access to the interior of the cab by the rescue services shall be possible on both sides of the cab by using one of the following emergency exit means: cab external doors (access directly from the exterior, as defined in clause 4.2.9.1.2.1 above) or side windows or emergency hatches.
- (2) In all cases, the emergency exit means shall provide a minimum clearance (free area) of 2000 cm² with a minimum inner dimension of 400 mm to allow the release of trapped persons.
- (3) Front position driver's cabs shall have at least an interior exit; this exit shall give access to an area of a minimum length of 2 metres, of a minimum clearance identical to those specified in clause 4.2.9.1.2.1, points (7) and (8), and this area (including its floor) shall be free of any obstruction to the escape of the driver; the above area shall be located on-board the unit, and can be an interior area or an area opened to the outside.

4.2.9.1.3 *External visibility*

4.2.9.1.3.1 *Front visibility*

- (1) The driver's cab shall be designed to allow the driver at his seated driving position a clear and unobstructed line of sight in order to distinguish fixed signals set to both the left and right of a straight track, and in curves with a radius of 300 m or more, under the conditions defined in Appendix F.
- (2) The above requirement shall also be met from the standing driving position under conditions defined in the Appendix F, on locomotives and on driving coaches, in case these coaches are intended to be also operated by a driver in standing position.

 OTIF	Uniform Technical Prescription (UTP)		UTP LOC&PAS	
	LOCOMOTIVES AND PASSENGER ROLLING STOCK		Page 115 of 272	
Status: DRAFT	Version: 03	TECH-20041 Annex	Original: EN	Date: 20.10.2020

- (3) For locomotives with central cab and for OTMs, in order to ensure the visibility of low signals, it is permitted that the driver moves to several different positions in the cab in order to meet the above requirement; it is not required to meet the requirement from the seated driving position.

4.2.9.1.3.2 *Rear and side view*

- (1) The cab shall be designed to allow the driver to have a rear view of each side of the train at stand still; this requirement is permitted to be met by one of the following means: opening side windows or panel at each side of the cab, exterior mirrors, camera system.
- (2) In case of opening side windows or panel used as that means to meet the requirement above in point (1), the opening shall be sufficiently large for the driver to put his head through the aperture; additionally, for locomotives and driving coaches intended to be used in a train composition with a locomotive, the design shall allow the driver at the same time to operate the emergency brake.

4.2.9.1.4 *Interior layout*

- (1) The interior layout of the cab shall take into account the anthropometric measurements of the driver as set out in the Appendix E.
- (2) Freedom of movement of personnel in the cab interior shall not be inhibited by obstructions.
- (3) The cab floor corresponding to the working area of the driver (access to the cab and foot rest excluded) shall be without any step.
- (4) The interior layout shall allow both seated and standing driving positions on locomotives and on driving coaches, in case these coaches are intended to be also operated by a driver in standing position.
- (5) The cab shall be equipped with at least one driver's seat (see clause 4.2.9.1.5) and additionally with a seat not considered as a driving position for possible accompanying crew.

4.2.9.1.5 *Driver's seat*

Requirements at component level:

- (1) The driver's seat shall be designed in such a way that it allows him to undertake all normal driving functions in a seated position, taking into account the anthropometric measurements of the driver as set out in the Appendix E. It shall allow for correct posture of the driver from the physiological point of view.
- (2) It shall be possible for the driver to adjust the seat position in order to meet the reference position of eyes for external visibility, as defined in clause 4.2.9.1.3.1.
- (3) Ergonomics and health aspects shall be considered in the design of the seat, and its use by the driver.

Requirements for integration in the driver's cab:

- (4) The mounting of the seat in the cab shall allow to meet external visibility requirements as specified in clause 4.2.9.1.3.1 above by using the range of adjustment provided by the seat (at component level); it shall not alter ergonomics and health aspects and the use of the seat by the driver.
- (5) The seat shall not constitute an obstacle for the driver to escape in case of emergency.

 OTIF	Uniform Technical Prescription (UTP)		UTP LOC&PAS	
	LOCOMOTIVES AND PASSENGER ROLLING STOCK		Page 116 of 272	
Status: DRAFT	Version: 03	TECH-20041 Annex	Original: EN	Date: 20.10.2020

- (6) The mounting of the driver's seat in locomotives, and in driving coaches, in case these coaches are intended to also be operated by a driver in standing position shall allow adjustment to get the necessary free space needed for the standing driving position.

4.2.9.1.6 Driver's desk- Ergonomics

- (1) The driver's desk and its operating equipment and controls shall be arranged to enable, in the most commonly used driving position, the driver to keep a normal posture, without hampering his freedom of movement, taking into account the anthropometric measurements of the driver as set out in the Appendix E.
- (2) To allow the display on the driver's desk surface of paper documents required during driving, a reading zone of minimum size 30 cm width per 21 cm high shall be available in front of the driver's seat.
- (3) Operating and control elements shall be clearly marked, so that they are identifiable by the driver.
- (4) If the traction and/or braking effort is set-up by a lever (combined one or separated ones), the "tractive effort" shall increase by pushing the lever forwards, and the "braking effort" shall increase by drawing the lever towards the driver.

If there is a position for emergency braking, it shall be clearly distinguished from those of the other positions of the lever (e.g. by a notch).

4.2.9.1.7 Climate control and air quality

- (1) The air in the cab shall be renewed to keep the CO₂ concentration to the levels specified in the clause 4.2.5.8 of this
- | | |
|------|----------------|
| UTP. | TSI |
|------|----------------|
- (2) At the seated driving position (as defined in the clause 4.2.9.1.3) of the driver's head and shoulders, there shall be no air flows caused by the ventilation system having an air velocity exceeding the limit value recognised to ensure a proper working environment.

4.2.9.1.8 Internal lighting

- (1) Cab general lighting shall be provided on driver's command in all normal operational modes of the rolling stock (included "switched off"). Its luminosity on desk level shall be higher than 75 lux at the level of the driver's desk, except for OTMs for which it shall be higher than 60 lux.
- (2) Independent lighting of the driver's desk reading zone shall be provided on driver's command, and shall be adjustable up to a value higher than 150 lux.
- (3) An independent lighting of instruments shall be provided, and shall be adjustable.
- (4) In order to prevent any dangerous confusion with outside operational signalling, no green lights or green illumination are permitted in a driver's cab, except for
- | | |
|---|--|
| cab signalling systems of which the design predates the entry into force of this UTP. | existing class B cab signalling systems (as defined in the CCS TSI). |
|---|--|

 OTIF	Uniform Technical Prescription (UTP)		UTP LOC&PAS	
	LOCOMOTIVES AND PASSENGER ROLLING STOCK		Page 117 of 272	
Status: DRAFT	Version: 03	TECH-20041 Annex	Original: EN	Date: 20.10.2020

4.2.9.2 Windscreen

4.2.9.2.1 *Mechanical characteristics*

- (1) The dimension, location, shape and finishes (including those for maintenance purpose) of the windows shall not inhibit the drivers external view (as defined in clause 4.2.9.1.3.1) and shall support the driving task.
- (2) The driver's cab windscreens shall be able to resist impacts from projectiles as specified in the specification referenced in Appendix J-1, index 55, clause 4.2.7 and shall resist spalling as specified in the same specification, clause 4.2.9.

4.2.9.2.2 *Optical characteristics*

- (1) The driver's cab windscreens shall be of an optical quality that does not alter the visibility of signs (shape and colour) in any operating condition (including as example when the windscreen is heated to prevent misting and frost).
- (2) The angle between primary and secondary images in the installed position shall be in accordance with limit values specified in the specification referenced in Appendix J-1, index 56, clause 4.2.2.
- (3) Permissible optical distortions of vision shall be as specified in the specification referenced in Appendix J-1, index 56, clause 4.2.3.
- (4) Haze shall be as specified in the specification referenced in Appendix J-1, index 56, clause 4.2.4.
- (5) Luminous transmittance shall be as specified in the specification referenced in Appendix J-1, index 56, clause 4.2.5.
- (6) Chromaticity shall be as specified in the specification referenced in Appendix J-1, index 56, clause 4.2.6.

4.2.9.2.3 *Equipment*

- (1) The windscreen shall be equipped with de-icing, de-misting and external cleaning means, under control of the driver.
- (2) The location, type and quality of windscreen cleaning and clearance devices shall ensure that the driver is able to maintain a clear external view in most weather and operating conditions, and shall not inhibit the drivers external view.
- (3) Protection shall be provided from the sun without reducing the drivers' view of external signs, signals and other visual information when this protection is in its stowed position.

4.2.9.3 Driver machine interface

4.2.9.3.1 *Driver's activity control function*

- (1) The driver's cab shall be equipped with a means to monitor the driver's activity, and to automatically stop the train when a lack of driver's activity is detected. This gives the on-board technical means for the railway undertaking to fulfil the requirement

 OTIF	Uniform Technical Prescription (UTP)		UTP LOC&PAS	
	LOCOMOTIVES AND PASSENGER ROLLING STOCK		Page 118 of 272	
Status: DRAFT	Version: 03	TECH-20041 Annex	Original: EN	Date: 20.10.2020

[to stop the train if the driver does not react within a certain time X as defined below](#). ~~as set out in Appendix K.~~

of clause 4.2.2.9 of OPE TSI.

(2) **Specification of the means to monitor (and detect a lack of) the driver's activity:**

The driver's activity shall be monitored when the train is in driving configuration and is moving (criterion for movement detection is at a low speed threshold); this monitoring shall be done by controlling the action of the driver on recognised driver interfaces such as dedicated devices (e.g. pedal, push buttons, sensitive touches...) and/or recognised driver interfaces with the Train Control and Monitoring System.

When no action is monitored on any of the recognised driver interfaces during more than a time of X seconds, a lack of driver's activity shall be triggered.

The system shall allow for the adjustment (at workshop, as a maintenance activity) of the time X within the range of 5 seconds to 60 seconds.

When the same action is monitored continuously for more than a time not higher than 60 seconds without any further action on a recognised driver interface, a lack of driver's activity shall also be triggered.

Before triggering a lack of driver's activity, a warning shall be given to the driver, in order for him to have the possibility to react and reset the system.

The system shall have the information "lack of driver's activity triggered" available for being interfaced to other systems (i.e. the radio system).

(3) **Additional requirement:**

The detection of the lack of the driver's activity is a function that shall be subject to a reliability study considering the failure mode of components, redundancies, software, periodic checks and other provisions, and the estimated failure rate of the function (lack of driver's activity as specified above not detected) shall be provided in the technical documentation defined in clause 4.2.12.

(4) **Specification of actions triggered at train level when a lack of driver's activity is detected:**

A lack of driver's activity when the train is in driving configuration and is moving (criterion for movement detection is at a low speed threshold) shall lead to a full service brake or an emergency brake application on the train.

In case of application of a full service brake, its effective application shall be automatically controlled and in case of non-application, it shall be followed by an emergency brake.

(5) **Notes:**

- It is allowed to have the function described in this clause fulfilled by the CCS Subsystem.
- The value of the time X has to be defined and justified by the railway undertaking (application of

operational rules and CSM,

TSI OPE and CSM,

and consideration of its current code of practice or means of compliance; outside of scope of the present

UTP).

~~TSI~~.

 OTIF	Uniform Technical Prescription (UTP)		UTP LOC&PAS	
	LOCOMOTIVES AND PASSENGER ROLLING STOCK		Page 119 of 272	
Status: DRAFT	Version: 03	TECH-20041 Annex	Original: EN	Date: 20.10.2020

- As a transitional measure, it is also allowed to install a system of a fix time X (no adjustment possible) provided that the time X is within the range of 5 seconds to 60 seconds and that the railway undertaking can justify this fix time (as described above).

- ~~A Member State may impose to the railway undertakings operating on its territory to adjust their rolling stock with a maximum limit for time X, if the Member state can demonstrate that this is needed to preserve the national safety level. In all other cases, Member States cannot prevent the access of a railway undertaking that is using a higher time Z (within the range specified).~~

- Contracting States may impose to the railway undertakings operating on their territory to adjust their rolling stock with a maximum limit for time X if this is required to maintain their level of safety.

- A Member State may impose to the railway undertakings operating on its territory to adjust their rolling stock with a maximum limit for time X, if the Member state can demonstrate that this is needed to preserve the national safety level. In all other cases, Member States cannot prevent the access of a railway undertaking that is using a higher time Z (within the range specified).

4.2.9.3.2 Speed indication

- (1) This function and the corresponding conformity assessment are

part of the specifications of the cab signalling system and shall comply with the rules applicable to the network. Compliance with the CCS TSI results in presumption of conformity with all speed indication requirements on all networks, unless specified differently in a National Technical Requirement applicable in accordance with APTU Article 12.

specified in the CCS TSI.

4.2.9.3.3 Driver display unit and screens

- (1) Functional requirements concerning the information and commands provided in the driver's cab are specified together with other requirements applicable to the specific function, in the clause describing that function. The same applies also to information and commands that may be provided by means of display units and screens.

ERTMS information and commands, including those provided on a display unit, are

part of the specifications of the cab signalling system and shall comply with the rules applicable to the network. Compliance with the CCS TSI results in presumption of conformity with all driver display unit and screen requirements on all networks, unless specified differently in a National Technical Requirement applicable in accordance with APTU Article 12.

specified in the CCS TSI.

- (2) For functions in the scope of this

UTP,

~~TSI,~~

 OTIF	Uniform Technical Prescription (UTP)		UTP LOC&PAS	
	LOCOMOTIVES AND PASSENGER ROLLING STOCK		Page 120 of 272	
Status: DRAFT	Version: 03	TECH-20041 Annex	Original: EN	Date: 20.10.2020

the information or commands to be used by the driver to control and command the train, and given by means of display units or screens, shall be designed to allow proper use and reaction from the driver.

4.2.9.3.4 Controls and indicators

- (1) Functional requirements are specified with other requirements applicable to a specific function, in the clause describing that function.
- (2) All indicator lights shall be designed so that they can be read correctly under natural or artificial lighting conditions, including incidental lighting.
- (3) Possible reflections of illuminated indicators and buttons in the windows of the driver's cab shall not interfere with the line of sight of the driver in his normal working position.
- (4) In order to prevent any dangerous confusion with outside operational signalling, no green lights or green illumination are permitted in a driver's cab, except for

cab signalling systems of which the design predates the entry into force of this UTP.	existing class B cab signalling system (according to CCS TSI).
---	--
- (5) Audible information generated by on-board equipment inside the cab for the driver shall be at least 6 dB(A) above the noise level in the cab (this noise level taken as reference being measured under conditions specified in the

UTP NOI).	NOI TSI).
-----------	----------------------

4.2.9.3.5 Labelling

- (1) The following information shall be indicated in the driving cabs:
 - Max. speed (V_{max}),
 - Identification number of rolling stock (traction vehicle number),
 - Location of portable equipment (e.g. self-rescue device, signals),
 - Emergency exit
- (2) Harmonised pictograms shall be used to mark controls and indicators in the cab.

4.2.9.3.6 Radio Remote control function by staff for shunting operation

- (1) If a radio remote control function is provided for a staff member to control the unit during shunting operations, it shall be designed to allow him to control the train movement safely, and to avoid any mistake when used.
- (2) It is assumed that the staff member using the remote control function can visually detect train movement when using the remote control device.
- (3) The design of the remote control function, including safety aspects, shall be assessed according to recognised standards.

 OTIF	Uniform Technical Prescription (UTP)		UTP LOC&PAS	
	LOCOMOTIVES AND PASSENGER ROLLING STOCK		Page 121 of 272	
Status: DRAFT	Version: 03	TECH-20041 Annex	Original: EN	Date: 20.10.2020

4.2.9.4 Onboard tools and portable equipment

- (1) A space shall be available in or near the driver's cab to store the following equipment, in case they are needed by the driver in emergency situation:
- Hand-lamp with red and white light
 - Short circuiting equipment for track-circuits
 - Scotches, if the parking brake performance is not sufficient depending on track gradient (see clause 4.2.4.5.5 "Parking brake").
 - A fire extinguisher (to be located in the cab; see also clause 4.2.10.3.1).
 - On manned traction units of freight trains: a self-rescue device,
for the driver and for other persons on board, satisfying the specifications of one of the two standards EN 402:2003 or 403:2004.
- as specified in the SRT TSI (see SRT TSI clause 4.7.1).

4.2.9.5 Storage facility for staff personal effects

- (1) Each driver's cab shall be equipped with:
- Two hooks for clothing or a niche with a clothes' beam.
 - A free space for storing a suitcase or bag of size 300 mm x 400 mm x 400 mm.

4.2.9.6 Recording device

- (1) As a minimum, the railway undertaking must record the following data:
- the passing of signals at danger or 'end of movement authority' without authority;
 - application of the emergency brake;
 - speed at which the train is running;
 - any isolation or overriding of the on-board train control (signalling) systems;
 - operation of the audible warning device (horn);
 - operation of door controls (release, closure);
 - detection by on-board hot axle box detectors, if fitted;
 - identity of the cab for which data are being recorded in order to be checked.
- The list of information to be recorded is defined in the OPE TSI.
- (2) The unit shall be equipped with a means to record this information, complying with the following requirements:

 OTIF	Uniform Technical Prescription (UTP)		UTP LOC&PAS	
	LOCOMOTIVES AND PASSENGER ROLLING STOCK		Page 122 of 272	
Status: DRAFT	Version: 03	TECH-20041 Annex	Original: EN	Date: 20.10.2020

- Functional requirements specified in the specification referenced in Appendix J-1, index 57, clauses 4.2.1, 4.2.2, 4.2.3 & 4.2.4 shall be met.
- Recording performance shall be according to class R1 of the specification referenced in Appendix J-1, index 57, clause 4.3.1.2.2.
- The integrity (consistency; correctness) of the recorded and extracted data shall be according to the specification referenced in Appendix J-1, index 57, clause 4.3.1.4.
- Data integrity shall be safeguarded according to the specification referenced in Appendix J-1, index 57, clause 4.3.1.5.
- The level of protection that applies to the protected storage medium shall be ‘A’ as defined in the specification referenced in Appendix J-1, index 57, clause 4.3.1.7.

4.2.10 Fire safety and evacuation

4.2.10.1 General and Categorisation

- (1) This clause applies to all units.
- (2) Rolling stock shall be designed such that it protects passengers and on-board staff in case of hazard fire on board and to allow an effective evacuation and rescue in case of emergencies. This is deemed to be fulfilled by complying with the requirements of this
- | | |
|------|----------------|
| UTP. | TSI |
|------|----------------|
- (3) The category of the unit regarding fire safety considered for its design, as defined in clause 4.1.4 of this
- | | |
|------------------|----------------|
| UTP . | TSI |
|------------------|----------------|
- shall be recorded in the technical documentation described in clause 4.2.12 of this
- | | |
|------|----------------|
| UTP. | TSI |
|------|----------------|

4.2.10.2 Measures to prevent fire

4.2.10.2.1 Material requirements

- (1) The selection of materials and components shall take into account their fire behaviour properties, such as flammability, smoke opacity and toxicity.
- (2) Materials used to construct the rolling stock unit shall comply with the requirements of the specification referenced in Appendix J-1, index 58 for the ‘Operation Category’ as defined below:
- ‘Operation Category 2’ for Category A passenger rolling stock (including passenger locomotive).
 - ‘Operation Category 3’ for Category B passenger rolling stock (including passenger locomotive).
 - ‘Operation Category 2’ for freight locomotives, and self-propelling units designed to carry other payload (mail, freight, etc.).

 OTIF	Uniform Technical Prescription (UTP)		UTP LOC&PAS	
	LOCOMOTIVES AND PASSENGER ROLLING STOCK		Page 123 of 272	
Status: DRAFT	Version: 03	TECH-20041 Annex	Original: EN	Date: 20.10.2020

- ‘Operation Category 1’ for OTMs, with requirements limited to areas which are accessible to staff when the unit is in transport running configuration (see section 2.3 of this

UTP).

~~TSD~~.

(3) In order to ensure constant product characteristics and manufacturing process, it is required that:

- the certificate to prove compliance of a material with the standard, which shall be issued immediately after testing of this material, shall be reviewed every 5 years.
- in case there is no change in the product characteristics and manufacturing process, and no change in the requirements

UTP),

~~(TSD)~~,

it is not required to perform new testing of this material; the certificate needs only to be updated regarding its date of issue.

4.2.10.2.2 Specific measures for flammable liquids

- (1) Railway vehicles shall be provided with measures preventing a fire from occurring and spreading due to leakage of flammable liquids or gases.
- (2) Flammable liquids used as cooling medium in high voltage equipment of freight locomotives shall be compliant to the requirement R14 of the specification referenced in Appendix J-1, index 59.

4.2.10.2.3 Hot axle box detection

Requirements are specified in clause 4.2.3.3.2 of the present

UTP.

~~TSD~~.

4.2.10.3 Measures to detect/control fire

4.2.10.3.1 Portable Fire extinguishers

- (1) This clause is applicable to units designed to carry passengers and/or staff.
- (2) The unit shall be equipped with adequate and sufficient portable fire extinguishers, in passenger and/or staff areas.
- (3) Water plus additive type fire extinguishers are deemed to be adequate for on-board rolling stock purposes.

4.2.10.3.2 Fire detection systems

- (1) The equipment and the areas on rolling stock that intrinsically impose a fire risk shall be equipped with a system that will detect fire at an early stage.
- (2) Upon fire detection the driver shall be notified and appropriate automatic actions shall be initiated to minimize the subsequent risk to passengers and train staff.

 OTIF	Uniform Technical Prescription (UTP)		UTP LOC&PAS	
	LOCOMOTIVES AND PASSENGER ROLLING STOCK		Page 124 of 272	
Status: DRAFT	Version: 03	TECH-20041 Annex	Original: EN	Date: 20.10.2020

- (3) For sleeping compartments, the detection of a fire shall activate an acoustic and optical local alarm in the affected area. The acoustic signal shall be sufficient to wake up the passengers. The optical signal shall be clearly visible and shall not be hidden by obstacles.

4.2.10.3.3 *Fire automatic fighting system for freight diesel units*

- (1) This clause is applicable to diesel powered freight locomotives and diesel powered freight self-propelling units.
- (2) These units shall be equipped with an automatic system capable of detecting a diesel fuel fire and of shutting down all relevant equipment and cutting off the fuel supply.

4.2.10.3.4 *Fire containment and control systems for passenger rolling stock*

- (1) This clause is applicable to units of category B passenger rolling stock.
- (2) The unit shall be equipped with adequate measures to control the spread of heat and fire effluents through the train.
- (3) The conformity with this requirement shall be deemed to be satisfied by the verification of conformity to the following requirements:
- The unit shall be equipped with full cross section partitions within passenger/staff areas of each vehicle, with a maximum separation of 30 meters which shall satisfy requirements for integrity for a minimum of 15 minutes (assuming the fire can start from either side of the partition), or with other Fire Containment and Control Systems (FCCS).
 - The unit shall be equipped with fire barriers that shall satisfy requirements for integrity and heat insulation for a minimum of 15 minutes at the following locations (where relevant for the concerned unit):
 - Between the drivers cab and the compartment to the rear of it (assuming the fire starts in the rear compartment).
 - Between combustion engine and adjacent passenger/staff areas (assuming the fire starts in the combustion engine).
 - Between compartments with electrical supply line and/or traction circuit equipment and passenger/staff area (assuming the fire starts in the electrical supply line and/or the traction circuit equipment).
 - The test shall be carried out in accordance with the requirements of the specification referenced in Appendix J-1, index 60.
- (4) If other FCCS are used instead of full cross section partitions within passenger/staff areas, the following requirements shall apply:
- They shall be installed in each vehicle of the unit, which is intended to carry passengers and/or staff,
 - They shall ensure that fire and smoke will not extend in dangerous concentrations over a length of more than 30 m within the passenger/staff areas inside the unit, for at least 15 minutes after the start of a fire.

The assessment of this parameter is an open point.

 OTIF	Uniform Technical Prescription (UTP)		UTP LOC&PAS	
	LOCOMOTIVES AND PASSENGER ROLLING STOCK		Page 125 of 272	
Status: DRAFT	Version: 03	TECH-20041 Annex	Original: EN	Date: 20.10.2020

- (5) If other FCCS are used and rely on reliability and availability of systems, components, or functions, they shall be subject to a reliability study considering the failure mode of components, redundancies, software, periodic checks and other provisions, and the estimated failure rate of the function (lack of control of the spread of heat and fire effluents) shall be provided in the technical documentation described in clause 4.2.12.

Based on this study, operating and maintenance conditions of the FCCS shall be defined and provided in the maintenance and operating documentation described in clauses 4.2.12.3 and 4.2.12.4.

4.2.10.3.5 Fire spreading protection measures for freight locomotives and freight self-propelling units

- (1) This clause is applicable to freight locomotives and to freight self-propelling units.
- (2) These units shall have a fire barrier to protect the driver's cab.
- (3) These fire barriers shall satisfy requirements for integrity and heat insulation for a minimum of 15 minutes; they shall be subject to a test carried out in accordance with the requirements of the specification referenced in Appendix J-1, index 61.

4.2.10.4 Requirements related to emergencies

4.2.10.4.1 Emergency lighting

- (1) To provide protection and safety on board in the event of emergency the trains shall be equipped with an emergency lighting system. This system shall provide a suitable lighting level in the passenger and in the service areas, as follows:
 - (2) for units of maximum design speed higher than or equal to 250 km/h, during a minimum operating time of three hours after the main energy supply has failed,
 - (3) for units of maximum design speed lower than 250 km/h, during a minimum operating time of 90 minutes after the main energy supply has failed.
- (4) Lighting level of at least 5 lux at floor level.
- (5) Values of lighting level for specific areas and conformity assessment methods shall be as specified in the specification referenced in Appendix J-1, index 62.
- (6) In the event of fire, the emergency lighting system shall continue to sustain at least 50 % of the emergency lighting in the vehicles not affected by fire for a minimum of 20 minutes. This requirement shall be deemed to be fulfilled by a satisfactory failure mode analysis.

4.2.10.4.2 Smoke Control

- (1) This clause is applicable to all units. In case of fire, the distribution of fumes shall be minimised in areas occupied by passengers and/or staff by application of the following requirements:
 - (2) To prevent outside smoke from entering the unit, it shall be possible to switch-off or close all means of external ventilation.

This requirement is verified on the rolling stock subsystem at unit level.

 OTIF	Uniform Technical Prescription (UTP)		UTP LOC&PAS	
	LOCOMOTIVES AND PASSENGER ROLLING STOCK		Page 126 of 272	
Status: DRAFT	Version: 03	TECH-20041 Annex	Original: EN	Date: 20.10.2020

- (3) To prevent smoke that could be inside a vehicle from spreading, it shall be possible to switch-off the ventilation and recirculation at vehicle level, this may be achieved by switching off the ventilation.
- (4) It is permissible to trigger these actions manually by the on-board staff, or by remote control; the triggering is permitted to be at train level, or at vehicle level.
- (5) For units intended to operate on lines that are fitted with the ETCS track side system for control-command and signaling (including “air tightness” information with references to Appendix J-2, index 3 of this UTP), as described in Annex A Index 7 of CCS TSI), the unit on-board control system shall be able to receive from the ETCS system the information related to air tightness.

4.2.10.4.3 Passenger alarm and communication means

Requirements are specified in clauses 4.2.5.2, 4.2.5.3 and 4.2.5.4 of the present

UTP.

~~TSI~~

4.2.10.4.4 Running capability

- (1) This clause is applicable to category A and category B passenger rolling stock (including passenger locomotives).
- (2) The unit shall be designed so that, in the event of fire on-board, the running capability of the train will enable it to run to a suitable fire fighting point.
- (3) Compliance shall be demonstrated by application of the specification referenced in Appendix J-1, index 63, in which the system functions impacted by a ‘type 2’ fire shall be:
- braking for rolling stock of fire safety category A: this function shall be assessed for a duration of 4 minutes.
 - braking and traction for rolling stock of fire safety category B: these functions shall be assessed for a duration of 15 minutes at a minimum speed of 80 km/h.

4.2.10.5 Requirements related to evacuation

4.2.10.5.1 Passenger emergency exits

- (1) This section is applicable to units designed to carry passengers.

Definitions and clarifications

- (2) Emergency exit: train borne provision to allow people inside the train to get out of the train in case of an emergency. An external passenger door is a specific type of emergency exit.
- (3) Through route: route through the train which can be entered and exited from different ends and which permits the movement of passengers and staff, along the longitudinal axis of the train without obstruction. Interior doors on the through route which are intended to be used by passengers in normal service and

 OTIF	Uniform Technical Prescription (UTP)		UTP LOC&PAS	
	LOCOMOTIVES AND PASSENGER ROLLING STOCK		Page 127 of 272	
Status: DRAFT	Version: 03	TECH-20041 Annex	Original: EN	Date: 20.10.2020

which can also be opened in case of power failure are considered not to obstruct the movement of passengers and staff.

- (4) Passenger area: area to which passengers have access without particular authorisation.
- (5) Compartment: Passenger area or staff area, which cannot be used as a through route for passengers or staff respectively.

Requirements

- (6) Emergency exits shall be provided in sufficient quantity along through route(s) on both sides of the unit; they shall be indicated. They shall be accessible and sufficient in size to allow the release of persons.
- (7) An emergency exit shall be able to be opened by a passenger from inside the train.
- (8) All external passenger doors shall be equipped with emergency opening devices allowing them to be used as emergency exits (see clause 4.2.5.5.9).
- (9) Each vehicle designed to contain up to 40 passengers shall have at least two emergency exits.
- (10) Each vehicle designed to contain more than 40 passengers shall have at least three emergency exits.
- (11) Each vehicle intended to carry passengers shall have at least one emergency exit on each vehicle side.
- (12) The number of the doors and their dimensions shall allow the complete evacuation within three minutes by passengers without their baggage. It is permitted to consider that passengers with reduced mobility are to be assisted by other passengers or staff, and that wheelchair users are evacuated without their wheelchair.

Verification of this requirement shall be made by a physical test under normal operating conditions.

4.2.10.5.2 Driver' cab emergency exits

Requirements are specified in clause 4.2.9.1.2.2 of the present

UTP.

~~TSI~~

4.2.11 Servicing

4.2.11.1 General

- (1) Servicing and minor repairs necessary to ensure safe operations between maintenance interventions shall be able to be carried out while the train is stabled away from its normal servicing home base.
- (2) This part gathers requirements for provisions relating to the servicing of trains during operation or when stabled on a network. Most of these requirements aim at ensuring that rolling stock will have the equipment necessary to meet the provisions required in the other sections of this

UTP

~~TSI~~

and of the

networks on which they are intended to be operated.

INF TSI.

 OTIF	Uniform Technical Prescription (UTP)		UTP LOC&PAS	
	LOCOMOTIVES AND PASSENGER ROLLING STOCK		Page 128 of 272	
Status: DRAFT	Version: 03	TECH-20041 Annex	Original: EN	Date: 20.10.2020

- (3) Trains shall be capable of remaining stabled, with no crew onboard, with power supply from the catenary or auxiliary power supply maintained for lighting, air conditioning, refrigerated cabinets, etc.

4.2.11.2 Train exterior cleaning

4.2.11.2.1 Cleaning of driver's cab windscreen

- (1) This clause is applicable to all units equipped with a driver's cab
- (2) It shall be possible for the front windows of drivers' cabs to be cleaned from outside the train without need to remove any component or covering.

4.2.11.2.2 Exterior cleaning through a washing plant

- (1) This clause is applicable to units fitted with traction equipment that are intended to be cleaned externally through a washing plant.
- (2) It shall be possible to control the speed of trains that are intended to be cleaned externally through a washing plant on level track at a value between 2 km/h and 5 km/h. This requirement is aimed at ensuring compatibility with washing plants.

4.2.11.3 Connection to Toilet discharge system

- (1) This clause is applicable to units equipped with sealed retention systems (using clear or recycled water) that have to be emptied at sufficient intervals on a scheduled basis at designated depots.
- (2) The following connections of the unit to the toilet discharge system shall comply with the following specifications:
- The 3" Evacuation nozzle (Inner part): see Appendix G-1.
 - The flushing connection for the toilet tank (Inner part), the use of which is optional: see Appendix G-1.

4.2.11.4 Water refilling equipment

- (1) This clause is applicable to units equipped with water taps covered by the clause 4.2.5.1 of this
- | | |
|------|-----------------|
| UTP. | TSI. |
|------|-----------------|
- (2) The water supplied to the train, up to the filling-interface with the rolling stock, on the interoperable network is deemed to be drinking water in accordance with ~~Directive 98/83/EC,~~
- | | |
|--|---|
| the provisions applicable in the state concerned, or according to equivalent regulations in force in the Contracting State. | Directive 98/83/EC, as specified in the clause 4.2.12.4 of the INF TSI. |
|--|---|

The on-board storage equipment shall not induce any additional risk for the health of people to the risks associated with the storage of water filled in accordance with the above provisions. This requirement is deemed to be met by assessment of piping and sealing material and quality. The materials shall be suitable for transport and storage of water fit for human consumption.

 OTIF	Uniform Technical Prescription (UTP)		UTP LOC&PAS	
	LOCOMOTIVES AND PASSENGER ROLLING STOCK		Page 129 of 272	
Status: DRAFT	Version: 03	TECH-20041 Annex	Original: EN	Date: 20.10.2020

4.2.11.5 Interface for water refilling

- (1) This clause is applicable to units equipped with a water tank supplying water to sanitary systems covered by the clause 4.2.5.1 of this

UTP.

~~TSI~~

- (2) The inlet connection for water tanks shall comply with figure 1 of the specification referenced in Appendix J-1, index 64.

4.2.11.6 Special requirements for stabling of trains

- (1) This clause is applicable to units intended to be powered while stabled.
- (2) The unit shall be compatible with at least one of the following external power supply systems, and shall be equipped (where relevant) with the corresponding interface for electrical connection to that external power supply (plug):
- (3) Power supply contact line (see clause 4.2.8.2.9 “Requirements linked to pantograph”).
- (4) “~~Single pole UIC 552 type~~” ~~train~~-power supply line (AC 1 kV, AC/DC 1.5 kV, DC 3 kV), in accordance with the specification referenced in Appendix J-1, index 111.
- (5) Local external auxiliary power supply 400 V that can be connected to socket type “3P+ground” according to the specification referenced in Appendix J-1, index 65.

4.2.11.7 Refuelling equipment

- (1) This clause is applicable to units equipped with a refuelling system.
- (2) Trains using diesel fuel in accordance with ~~Annex II of Directive 2009/30/EC~~¹⁴
~~, or in accordance with the provisions applicable in the state concerned equivalent regulations applicable in the Contracting States,~~ Annex II of Directive 2009/30/EC¹⁵
shall be equipped with refuelling couplings on both sides of the vehicle, at a maximum height of 1500 mm above rail level; they shall be circular with a minimum diameter of 70 mm.
- (3) Trains using another type of diesel fuel shall be equipped with a fool proof opening and fuel tank to prevent inadvertent refuelling with a wrong fuel.
- (4) The type of coupling for refuelling shall be recorded in the technical documentation.

¹⁴- [OJ L 140, 5.6.2009, p. 88–113](#)

¹⁵- [OJ L 140, 5.6.2009, p. 88–113](#)

 OTIF	Uniform Technical Prescription (UTP)		UTP LOC&PAS	
	LOCOMOTIVES AND PASSENGER ROLLING STOCK		Page 130 of 272	
Status: DRAFT	Version: 03	TECH-20041 Annex	Original: EN	Date: 20.10.2020

4.2.11.8 Train interior cleaning - power supply

- (1) For units of maximum speed higher than or equal to 250 km/h, a 3 000 VA at 230 V, 50 Hz electrical power supply connection shall be provided inside the unit; they shall be spaced such that no part of the unit that needs to be cleaned is more than 12 meters from one of the sockets.

4.2.12 Documentation for operation and maintenance

- (1) The requirements specified in this clause 4.2.12 apply to all units.

4.2.12.1 General

- (1) This clause 4.2.12 of the

UTP

~~TSI~~

describes the documentation requested

in Section 2 of UTP GEN-C¹⁶:

in clause 2.4(a) of Annex ~~IV~~ of Directive ([EU](#) [2016/797](#) ~~2008/57/EC~~) (clause titled “Technical file”):

“technical characteristics linked to the design including general and detailed drawings with respect to execution, electrical and hydraulic diagrams, control-circuit diagrams, description of data-processing and automatic systems, documentation on operation and maintenance, etc., relevant for the subsystem concerned”.

- (2) This documentation, being part of the technical file, is compiled by the

assessing entity

~~notified body~~[applicant](#)

and has to accompany the

UTP declaration of verification.

~~EC declaration of verification.~~

[It is kept by the](#)

[keeper](#)

[applicant](#)

[throughout the service life of the subsystem.](#)

- (3) ~~This documentation, being part of the technical file, is lodged with the applicant, and is kept by the applicant throughout the service life of the subsystem. The~~

[keeper](#)

[applicant or entity authorised by the applicant \(e.g. a keeper\)](#)

¹⁶ ~~Technical File – General Provisions, UTP GEN-C of 1 December 2017, APTU (A 94 01C/1.2011)~~

 OTIF	Uniform Technical Prescription (UTP)		UTP LOC&PAS	
	LOCOMOTIVES AND PASSENGER ROLLING STOCK		Page 131 of 272	
Status: DRAFT	Version: 03	TECH-20041 Annex	Original: EN	Date: 20.10.2020

shall provide the part of this documentation required to manage the maintenance documentation as defined in the

Article 9.1(a) of Annex A to ATMF (ECM | art 14(3)(b) of Directive (EU) 2016/798 of the European Parliament and of the Council¹⁷

to the entity in charge of maintenance as soon as it is assigned for the maintenance of the unit.

- (4) The documentation ~~requested is related to the basic parameters identified in this~~ also includes a list of safety critical components. Safety critical components are components for which a single failure has a credible potential to lead directly to a serious accident as defined in

Article 2 (z) of ATMF.~~UTP.~~

| Article 3(12) of Directive (EU) 2016/798.~~TSI.~~

- (5) ~~The Its-~~ content of the documentation is described in the clauses below.

4.2.12.2 General documentation

The following documentation describing the rolling stock shall be provided:

- (1) General drawings.
- (2) Electrical, pneumatic and hydraulic diagrams, Control-circuit diagrams necessary to explain the function and operation of the concerned systems.
- (3) Description of computerised onboard systems including description of functionality, specification of interfaces and data processing and protocols.
- (3a) For units designed and assessed for general operation, this shall include a description of the electric interfaces between units and of communication protocols, with the reference to the standards or other normative documents that have been applied. Communication protocols (if used) shall comply with the specification referenced in Appendix J-1, index 112.
- (4) Reference profile, and compliance to interoperable reference contours G1, GA, GB, GC or DE3, as required in clause 4.2.3.1.
- (5) Weight balance with hypothesis on load conditions considered, as required in clause 4.2.2.10.
- (6) Axle load and spacing of axles, as required in clause 4.2.3.2.1.
- (7) Test report concerning running dynamic behaviour, including the test track quality recording and the track loading parameters including possible limitations of use if testing of the vehicle only covers a part of the test conditions, as required in clause 4.2.3.4.2.
- (8) The hypothesis taken to evaluate the loads due to bogie running, as required in clauses 4.2.3.5.1 and in clause 6.2.3.7 for wheelsets.
- (9) Braking performance, including failure mode analysis (degraded mode) as required in clause 4.2.4.5.

¹⁷- [Directive \(EU\) 2016/798 of the European Parliament and of the Council of 11 May 2016 on railway safety \(OJ L 138, 26.5.2016, p. 102\)](#)

 OTIF	Uniform Technical Prescription (UTP)		UTP LOC&PAS	
	LOCOMOTIVES AND PASSENGER ROLLING STOCK		Page 132 of 272	
Status: DRAFT	Version: 03	TECH-20041 Annex	Original: EN	Date: 20.10.2020

- 9a) [Maximum distance between the eddy current track brake and the track corresponding to “brake released”, fixed speed threshold, vertical force and braking force as a function of the train speed, for the case of full application of eddy current track brake \(emergency braking\) and limited application of eddy current brake \(service braking\), as required in clause 4.2.4.8.3.](#)
- (10) The presence and type of toilets in a unit, the characteristics of the flushing medium, if it is not clean water, the nature of the treatment system for released water and the standards against which conformity has been assessed, as required in clause 4.2.5.1.
- (11) Provisions taken in relation with the selected range of environmental parameters if different than the nominal one, as required in clause 4.2.6.1.
- (12) Characteristic wind curve (CWC) as required in clause 4.2.6.2.4.
- (13) Traction performance, as required in clause 4.2.8.1.1.
- (14) Fitment of an on-board energy measurement system, and of its on-board location function (optional), as required in clause 4.2.8.2.8.; [Description of on-board to ground communication and the metrological control including functions related to the accuracy classes of the voltage measurement, current measurement and energy calculation.](#)
- (15) Hypothesis and data considered for the compatibility study for AC systems, as required in clause 4.2.8.2.7.
- (16) The number of pantographs simultaneously in contact with the overhead contact line equipment (OCL), their spacing and the OCL design distance type (A, B or C) used for assessment tests, as required in clause 4.2.8.2.9.7.

4.2.12.3 Documentation related to Maintenance

- (1) Maintenance is a set of activities intended to keep a functional unit in, or to restore it to, a state in which it can perform its required function, ensuring continued integrity of safety systems and compliance with applicable standards.

The following information necessary to undertake maintenance activities on rolling stock shall be provided:

- The maintenance design justification file: explains how maintenance activities are defined and designed in order to ensure that the rolling stock characteristics will be kept within acceptable limits of use during its lifetime.

The [maintenance design justification](#) file shall give input data in order to determine the criteria for inspection and the periodicity of maintenance activities.

- The maintenance description file: explains how maintenance activities [are recommended to](#) ~~shall~~ be performed.

 OTIF	Uniform Technical Prescription (UTP)		UTP LOC&PAS	
	LOCOMOTIVES AND PASSENGER ROLLING STOCK		Page 133 of 272	
Status: DRAFT	Version: 03	TECH-20041 Annex	Original: EN	Date: 20.10.2020

4.2.12.3.1 The maintenance design justification file

The maintenance design justification file shall contain:

(1) Precedents, principles and methods used to design the maintenance of the unit.

[\(1a\) Precedents, principles and methods used to identify the safety critical components and their specific operational, servicing, maintenance and traceability requirements.](#)

(2) Utilisation profile: Limits of the normal use of the unit (e.g. km/month, climatic limits, authorised types of loads etc.).

(3) Relevant data used to design the maintenance and origin of these data (return of experience).

(4) Tests, investigations and calculations carried out to design the maintenance.

Resultant means (facilities, tools...) needed for the maintenance are described in clause 4.2.12.3.2 “maintenance documentation”.

4.2.12.3.2 The Maintenance description file

(1) The maintenance description file shall describe how maintenance activities shall be conducted.

(2) Maintenance activities include all activities necessary such as inspections, monitoring, tests, measurements, replacements, adjustments, repairs.

(3) Maintenance activities are split into:

- Preventive maintenance; scheduled and controlled
- Corrective maintenance

The maintenance description file shall include the following:

(4) Component hierarchy and functional description: The hierarchy sets up the boundaries of the rolling stock by listing all the items belonging to the product structure of that rolling stock and using an appropriate number of discrete levels. The lowest item of the hierarchy shall be a replaceable unit.

(5) Schematic circuit diagrams, connection diagrams and wiring diagrams.

(6) Parts list: The parts list shall contain the technical and functional descriptions of the spare parts (replaceable units).

The list shall include all parts specified for changing on condition, or which may require replacement following electrical or mechanical malfunction, or which will foreseeable require replacement after accidental damage (e.g. windscreen).

Interoperability constituent shall be indicated and referenced to their corresponding declaration of conformity.

[\(6a\) Safety critical components list: The safety critical components list shall contain the specific servicing, maintenance and servicing/maintenance traceability requirements.](#)

(7) The limit values for components which shall not be exceeded in service shall be stated; the possibility of specifying operational restrictions in degraded mode (limit value reached) is permitted.

 OTIF	Uniform Technical Prescription (UTP)		UTP LOC&PAS	
	LOCOMOTIVES AND PASSENGER ROLLING STOCK		Page 134 of 272	
Status: DRAFT	Version: 03	TECH-20041 Annex	Original: EN	Date: 20.10.2020

(8) European

or other applicable

legal obligations: where components or systems are subject to specific European

or other applicable

legal obligations these obligations shall be listed.

(9) The structured set of tasks that include the activities, procedures, means proposed by the applicant to carry out the maintenance task.

(10) The description of the maintenance activities.

The following aspects have to be documented (when they are specific to the application):

- Disassembly/assembly instructions drawings necessary for correct assembly/disassembly of replaceable parts
- Maintenance criteria
- Checks and tests
- Tools and materials required to undertake the task (special tools)
- Consumables required to undertake the task
- Personal protective safety provision and equipment (special)

(11) Necessary tests and procedures to be undertaken after each maintenance operation before re-entry into service of rolling stock.

(12) Troubleshooting (fault diagnosis) manuals or facilities for all reasonably foreseeable situations; this includes functional and schematic diagrams of the systems or IT-based fault finding systems.

4.2.12.4 Operating documentation

The technical documentation necessary to operate the unit is composed of:

(1) A description of operation in normal mode, including the operational characteristics and limitations of the unit (e.g. vehicle gauge, maximum design speed, axle loads, brake performance, [type\(s\) and operation of track gauge changeover facility\(ies\) the unit is compatible with...](#)).

(2) A description of the various reasonably foreseeable degraded modes in case of safety significant failures of equipment or functions described in this

UTP,

~~TSI~~,

together with the related acceptable limits and operating conditions of the unit that could be experienced.

(3) A description of the control and monitoring systems allowing the identification of safety significant failures of equipment or functions described in this

UTP

~~TSI~~

 OTIF	Uniform Technical Prescription (UTP)		UTP LOC&PAS	
	LOCOMOTIVES AND PASSENGER ROLLING STOCK		Page 135 of 272	
Status: DRAFT	Version: 03	TECH-20041 Annex	Original: EN	Date: 20.10.2020

(e.g clause 4.2.4.9 related to the function “braking”).

(3a) [Safety critical components list: The safety critical components list shall contain the specific operational and traceability requirements.](#)

(4) This technical operating documentation shall be part of the technical file.

4.2.12.5 Lifting diagram and instructions

The documentation shall include:

- (1) A description of procedures for lifting and jacking and related instructions.
- (2) A description of interfaces for lifting and jacking.

4.2.12.6 Rescue related descriptions

The documentation shall include:

- (1) A description of procedures for use of emergency measures and related necessary precautions to be taken, as e.g. use of emergency exits, entrance to RST for rescue, isolation of brakes, electrical earthing, towing.
- (2) A description of effects when the described emergency measures are taken, e.g. reduction of brake performance after isolation of brakes.

4.3 Functional and technical specification of the interfaces

The following sections contain tables 6, 7, 8, 9 and 10, with a five-column table layout. The first three columns on the left are part of this UTP.

The second column from the left also appears in the equivalent EU TSI, although the title of this column has been adapted in order to fit both the EU and the OTIF document.

 OTIF	Uniform Technical Prescription (UTP)		UTP LOC&PAS	
	LOCOMOTIVES AND PASSENGER ROLLING STOCK		Page 136 of 272	
Status: DRAFT	Version: 03	TECH-20041 Annex	Original: EN	Date: 20.10.2020

4.3.1 Interface with Energy subsystem

Table 6 Interface with the Energy subsystem

Reference to the OTIF regulations	Reference in this UTP/TSI		Reference Energy TSI subsystem	TSI-ENE TSI ¹⁸
	Parameter	Point	Parameter	Point
<p>In accordance with ATMF Article 6 §2, it is the responsibility of the railway undertaking to ensure the compatibility of the vehicle with the infrastructure it is operated on.</p> <p>The interface requirements linked to the energy subsystem are set out in section 4.2.8.2 of this UTP.</p>	Gauging	4.2.3.1	Pantograph gauge	4.2.10
	Pantograph head geometry	4.2.8.2.9.2		Appendix D
	Operation within range of voltages and frequencies	4.2.8.2.2	Voltage and frequency	4.2.3
	-Max current from OCL	4.2.8.2.4	Parameters relating to supply system performance:	4.2.4
	-Power factor	4.2.8.2.6		4.2.4
	-Maximum current at standstill	4.2.8.2.5		4.2.4
				4.2.5
	Regenerative brake with energy to OCL	4.2.8.2.3	Regenerative braking	4.2.6
	Energy consumption measuring function	4.2.8.2.8	On-ground energy data collecting system	4.2.17
	-Height of pantograph	4.2.8.2.9.1	Geometry of the overhead contact line	4.2.9
- Pantograph head geometry	4.2.8.2.9.2			
Contact strip material	4.2.8.2.9.4	Contact wire material	4.2.14	
Pantograph static contact force	4.2.8.2.9.5	Mean contact force	4.2.11	
Pantograph contact force and dynamic behaviour	4.2.8.2.9.6	Dynamic behaviour and quality of current collection	4.2.12	
Arrangements of pantographs	4.2.8.2.9.7	Pantograph spacing	4.2.13	
Running through phase or system separation section	4.2.8.2.9.8	Separation sections:		
		- phase	4.2.15	
		- system	4.2.16	

¹⁸- [Commission Regulations \(EU\) No 321/2013 as last amended by Commission Implementing Regulation \(EU\) 2019/776 of 16 May 2019. There are no equivalent OTIF rules.](#)

 OTIF	Uniform Technical Prescription (UTP)		UTP LOC&PAS	
	LOCOMOTIVES AND PASSENGER ROLLING STOCK		Page 137 of 272	
Status: DRAFT	Version: 03	TECH-20041 Annex	Original: EN	Date: 20.10.2020

Reference to the OTIF regulations	Reference in this UTP/TSI		Reference Energy TSI subsystem	TSI-ENE TSI ¹⁸
	Parameter	Point	Parameter	Point
	Electrical protection of the train	4.2.8.2.10	Electrical Protection Coordination Arrangements	4.2.7
	System energy disturbances for AC systems	4.2.8.2.7	Harmonics and Dynamic Effects for AC traction power supply systems	4.2.8

4.3.2 Interface with Infrastructure subsystem

Table 7 Interface with the Infrastructure subsystem

Reference to the OTIF or national regulations	Reference in this UTP/TSI		Reference Infrastructure TSI/UTP	UTP INF
	Parameter	Point	Parameter	Point
There are no infrastructure requirements in OTIF regulations.	Rolling stock kinematic gauge	4.2.3.1	Structure gauge	4.2.3.1
			Distance between track centres	4.2.3.2
In accordance with ATMF Article 6 § 2, it is the responsibility of the railway undertaking to ensure the compatibility of the vehicle with the infrastructure it is operated on.	Axle load parameter	4.2.3.2.1	Minimum radius of vertical curve	4.2.3.5
			Track resistance to vertical loads	4.2.6.1
			Lateral track resistance	4.2.6.3
			Resistance of new bridges to traffic loads	4.2.7.1
The track design and layout are the responsibility of the Contracting State.	Running dynamic behaviour	4.2.3.4.2.	Equivalent vertical loading for new earthworks and earth pressure effects	4.2.7.2
			Resistance of existing bridges and earthworks to traffic loads	4.2.7.4
The interface requirements at vehicle level are set	Running dynamic limit values for track loading	4.2.3.4.2.2	Cant deficiency	4.2.4.3
	Equivalent conicity	4.2.3.4.3	Track resistance to vertical loads	4.2.6.1
			Lateral track resistance	4.2.6.3
			Equivalent conicity	4.2.4.5



Reference to the OTIF or national regulations	Reference in this UTP/TSI		Reference Infrastructure TSI/UTP	UTP INF
	Parameter	Point	Parameter	Point
out in section 4.2.3 of this UTP.	Geometrical characteristics of wheelset	4.2.3.5.2.1	Nominal track gauge	4.2.4.1
	Geometrical characteristics of wheels	4.2.3.5.2.2	Rail head profile for plain line	4.2.4.6
	Automatic variable gauge wheelsets systems	4.2.3.5.2.3	In service geometry of switches and crossings	4.2.5.3
	Minimum curve radius	4.2.3.6	Minimum radius of horizontal curve	4.2.3.4
	Maximum average deceleration	4.2.4.5.1	Longitudinal track resistance	4.2.6.2
			Actions due to traction and braking	4.2.7.1.5
	Slipstream effects	4.2.6.2.1	Resistance of new structures over or adjacent to tracks	4.2.7.3
	Head pressure pulse	4.2.6.2.2	Maximum pressure variations in tunnels	4.2.10.1
	Maximum pressure variations in tunnels	4.2.6.2.3	Distance between track centres	4.2.3.2
	Crosswind	4.2.6.2.4	Effect of crosswinds	4.2.10.2
Aerodynamic effect on ballasted track	4.2.6.2.5	Ballast pick-up	4.2.10.3	
Toilet discharge system	4.2.11.3	Toilet discharge	4.2.12.2	
Exterior cleaning through a washing plant	4.2.11.2.2	Train external cleaning facilities,	4.2.12.3	
Water refilling equipment:	4.2.11.4	Water restocking,	4.2.12.4	
Interface for water refilling	4.2.11.5			
Refuelling equipment	4.2.11.7	Refuelling	4.2.12.5	
Special requirements for stabling of trains	4.2.11.6	Electric shore supply	4.2.12.6	

 OTIF	Uniform Technical Prescription (UTP)		UTP LOC&PAS	
	LOCOMOTIVES AND PASSENGER ROLLING STOCK		Page 139 of 272	
Status: DRAFT	Version: 03	TECH-20041 Annex	Original: EN	Date: 20.10.2020

4.3.3 Interface with Operation subsystem

Table 8 Interface with the Operation subsystem

Reference to the OTIF or national regulations	Reference in this UTP/TSI		Reference Operation subsystem TSI		OPE TSI ¹⁹
	Parameter	Point	Parameter	Point	
COTIF does not define contingency arrangements; national contingency arrangements apply. The requirements in section 4.2.2.2.4 are deemed compatible with all national contingency measures.	Rescue coupling	4.2.2.2.4	Contingency arrangements		4.2.3.6.3
In accordance with ATMF Article 6§2, it is the responsibility of the railway undertaking to ensure the compatibility of the vehicle with the infrastructure it is operated on.	Axle load parameter	4.2.3.2	Train composition		4.2.2.5
	Braking performance	4.2.4.5	Train braking		4.2.2.6
	External front and rear lights	4.2.7.1	Train visibility		4.2.2.1
	Horn	4.2.7.2	Train audibility		4.2.2.2
	External visibility	4.2.9.1.3	Requirements for lineside signal and marker sighting		4.2.2.8
	Optical characteristics of the windscreen	4.2.9.2.2			
	Internal lighting	4.2.9.1.8			
Driver's activity control function	4.2.9.3.1	Driver vigilance		4.2.2.9	
Recording device	4.2.9.6	Recording of supervision data on-board the train		4.2.3.5.2	

¹⁹- [Commission Implementing Regulation \(EU\) 2019/773 of 16 May 2019 on the technical specification for interoperability relating to the operation and traffic management subsystem of the rail system within the European Union and repealing Decision 2012/757/EU. There are no equivalent OTIF rules.](#)

 OTIF	Uniform Technical Prescription (UTP)		UTP LOC&PAS	
	LOCOMOTIVES AND PASSENGER ROLLING STOCK		Page 140 of 272	
Status: DRAFT	Version: 03	TECH-20041 Annex	Original: EN	Date: 20.10.2020

4.3.4 Interface with the Control, command and signalling subsystem

Table 9 Interface with the Control, command and signaling subsystem

Reference to the OTIF or national regulations	Reference in this UTP/TSI		Reference <u>CCS</u> subsystem <u>CCS-TSI</u>	<u>CCS TSI</u> ²⁰
	Parameter	Point	Parameter	Point
<p>In accordance with ATMF Article 6§2, it is the responsibility of the railway undertaking to ensure the compatibility of the vehicle with the infrastructure it is operated on.</p> <p>The interfaces for compatibility with train detection systems, control, command and signalling system are set out in Appendix J-2 index 1 of this UTP.</p>	Rolling stock characteristics compatible with train detection system based on track circuits	4.2.3.3.1.1	Vehicle geometry Vehicle design Isolating emissions EMC	Specification referenced in Annex A, Index 77 of TSI CCS (Appendix J-2 index 1 of this UTP)
	Rolling stock characteristics compatible with train detection system based on axle counters	4.2.3.3.1.2	Vehicle geometry Wheel geometry Vehicle design EMC	Specification referenced in Annex A, Index 77 of TSI CCS
	Rolling stock characteristics compatible with loop equipment	4.2.3.3.1.3	Vehicle design	Specification referenced in Annex A, Index 77 of TSI CCS
	Emergency braking command	4.2.4.4.1	On-board ETCS functionality	4.2.2
	Emergency braking performance	4.2.4.5.2	Guaranteed train braking performance and characteristics	4.2.2
	Train departing from platform	4.2.5.3	FIS for the train interface	Specification referenced in Annex A, Index 7 of TSI CCS (Appendix J-2, index 3 of this UTP),
	Door opening	4.2.5.5		
Separation sections	4.2.8.2.9.8			
Smoke control	4.2.10.4.2			

²⁰ Commission Regulation (EU) 2016/919 of 27 May 2016 on the technical specification for interoperability relating to the 'control-command and signalling' subsystems of the rail system in the European Union as last amended by Commission Implementing Regulation (EU) 2020/420 of 16 March 2020. There are no equivalent OTIF rules.

 OTIF	Uniform Technical Prescription (UTP)		UTP LOC&PAS	
	LOCOMOTIVES AND PASSENGER ROLLING STOCK		Page 141 of 272	
Status: DRAFT	Version: 03	TECH-20041 Annex	Original: EN	Date: 20.10.2020

Reference to the OTIF or national regulations	Reference in this UTP/ TSI		Reference CCS subsystem CCS-TSI	<u>CCS TSI²⁰</u>
	Parameter	Point	Parameter	Point
	External visibility	4.2.9.1.3	Visibility of track-side Control-command objects	4.2.15

4.3.5 Interface with the Telematic application for passengers subsystem

Table 10 Interface with the Telematic application for passengers subsystem

Reference to the OTIF or national regulations	Reference in this UTP/ TSI		Reference Telematic application for passengers TSI	<u>TAP TSI²¹</u>
	Parameter	Point	Parameter	Point
There are no harmonised requirements for telematics applications for passengers in OTIF.	Customer information (PRM)	4.2.5	On board device display	4.2.13.1
	Public address system	4.2.5.2	Automatic voice and announcement	4.2.13.2
	Customer information (PRM)	4.2.5		

4.4 Operating rules

- (1) In light of the essential requirements mentioned in Section 3, the provisions for operation of the rolling stock in the scope of this

UTP

~~TSI~~

are described in:

- Clause 4.3.3 “Interface with operation subsystem”, which refers to the relevant clauses of the Section 4.2 of this

UTP.

~~TSI~~

- Clause 4.2.12 “Documentation for Operation and Maintenance”

- (2) In accordance with Article 15a of ATMF ~~the~~ railway undertaking shall control the risks associated with the use of the unit. Operating rules are developed under the railway undertaking safety management system, with consideration of these provisions.

²¹- [Commission Regulation \(EU\) No 454/2011 of 5 May 2011 on the technical specification for interoperability relating to the subsystem ‘telematics applications for passenger services’ of the trans-European rail system as last amended by Commission Implementing Regulation \(EU\) 2019/775 of 16 May 2019.](#)

 OTIF	Uniform Technical Prescription (UTP)		UTP LOC&PAS	
	LOCOMOTIVES AND PASSENGER ROLLING STOCK		Page 142 of 272	
Status: DRAFT	Version: 03	TECH-20041 Annex	Original: EN	Date: 20.10.2020

Operating rules covering the activities ~~and measures set out in Appendix K~~ of the railway undertaking shall ~~therefore~~ be established ~~to ensure that the trains in which units are incorporated comply with the essential requirements~~²².

- (3) In particular, operating rules are necessary to ensure that a train stopped on a gradient as specified in clauses 4.2.4.2.1 and 4.2.4.5.5 of this

UTP

~~TSI~~

(requirements related to braking) will be immobilised.

The operating rules for use of the public address system, the passenger alarm, the emergency exits, the operation of the access doors are elaborated with consideration of the relevant provisions of this

UTP

~~TSI~~

and of the documentation for operation.

- (3a) For the safety critical components, the specific operational and operational traceability requirements are developed by the designers/manufacturers at design phase and through a collaboration between designers/manufacturers and the concerned railway undertakings after vehicles have entered into operation.

- (4) The technical operating documentation described in clause 4.2.12.4 gives the rolling stock characteristics to be considered in order to define the operating rules in degraded mode.

- (5) Procedures for lifting and rescue are established (including the method and the means of recovering a derailed train or a train that is unable to move normally) with consideration of:

- the provisions for lifting and jacking described in clauses 4.2.2.6 and 4.2.12.5 of this

UTP;

~~TSI;~~

- the provisions related to the braking system for rescue described in clauses 4.2.4.10 and 4.2.12.6 of this

UTP.

~~TSI.~~

- (6) The safety rules for trackside workers or passengers on platforms are developed by the entity(ies) responsible for fixed installations with consideration of the relevant provisions of this

UTP

~~TSI~~

and of the technical documentation (e.g. impact of speed).

²² Unlike EU law, where the RU is responsible, OTIF law does not specify who should establish these operating rules.

 OTIF	Uniform Technical Prescription (UTP)		UTP LOC&PAS	
	LOCOMOTIVES AND PASSENGER ROLLING STOCK		Page 143 of 272	
Status: DRAFT	Version: 03	TECH-20041 Annex	Original: EN	Date: 20.10.2020

4.5 Maintenance rules

- (1) In light of the essential requirements mentioned in Section 3, the provisions for maintenance of the rolling stock in the scope of this

UTP:

~~TSI~~

- Clause 4.2.11 “Servicing”
- Clause 4.2.12 “Documentation for Operation and Maintenance”.

- (2) Other provisions in the section 4.2 (clauses 4.2.3.4 and 4.2.3.5) specify for particular characteristics the limit values that have to be verified during maintenance activities.

(2a) The safety critical components and their specific servicing, maintenance and maintenance traceability requirements are identified by the designers/manufacturers at design phase and through a collaboration between designers/manufacturers and the concerned entities in charge of maintenance after vehicles have entered into operation.

- (3) From the information mentioned above and provided in the clause 4.2, the appropriate tolerances and intervals to ensure compliance with the essential requirements throughout the lifetime of the rolling stock are defined at maintenance operational level by and under the sole responsibility of entities in charge of maintenance (not in the scope of the assessment against this

UTP);

~~TSI~~;

this activity includes:

- The definition of the in-service values where they are not specified in this

UTP,

~~TSI~~,

or where operating conditions allow the use of different in-service limit values than those specified in this

UTP.

~~TSI~~.

- The justification of the in-service values, by providing the equivalent information to those required in clause 4.2.12.3.1 “The maintenance design justification file”.

- (4) On the basis of the information mentioned above in this clause, a maintenance plan is defined at maintenance operational level by and under the sole responsibility of the entities in charge of maintenance (not in the scope of the assessment against this

UTP),

~~TSI~~;

consisting in a structured set of maintenance tasks that include the activities, tests and procedures, means, maintenance criteria, periodicity, working time required to carry out the maintenance tasks.

- (5) For on-board software, the designer/manufacture shall specify, for any on-board software modification, all maintenance requirements and procedures (including health monitoring, diagnosis of events, test methods and tools and also the required professional competence) necessary for achieving essential

 OTIF	Uniform Technical Prescription (UTP)		UTP LOC&PAS	
	LOCOMOTIVES AND PASSENGER ROLLING STOCK		Page 144 of 272	
Status: DRAFT	Version: 03	TECH-20041 Annex	Original: EN	Date: 20.10.2020

[requirements and values quoted in the mandatory requirements of this UTP throughout the life-cycle \(Installation, normal operation, failures, repair work, checking and maintenance, decommissioning, etc.\).](#)

4.6 Professional competencies

- (1) The professional competencies of staff required for

the operational activities relating to train composition and the use of vehicles within their limits and conditions of use are set out in section 4.4 Operating Rules of this UTP²³ [and the UTP on train composition and route compatibility checks](#).

the operation of the rolling stock in the scope of this TSI are not set out in this TSI.

~~They are partly covered by~~

- (2) ~~Appendix K~~ [Additional rules may apply in each Contracting State.](#)

They are partly covered by the OPE TSI and Directive 2007/59/EC²⁴

~~, or according to the regulations in the Contracting State that prescribe specifications for train drivers operating locomotives and trains.~~

~~and Directive 2007/59/EC²⁵~~

4.7 Health and safety conditions

- (1) The provisions for health and safety of staff required for the operation and maintenance of the rolling stock in the scope of this

UTP

~~TSI~~

are covered by the essential requirements No. 1.1, 1.3, 2.5.1, 2.6.1

(as numbered in a UTP GEN-A);

(as numbered in Directive [\(EU\) 2016/797](#)~~2008/57/EC~~);

the table in section 3.2 mentions the technical clauses of this

UTP

~~TSI~~

in relation to these essential requirements.

- (2) In particular, the following provisions of section 4.2 specify provisions for health and safety of staff:

- Clause 4.2.2.2.5: Staff access for coupling and uncoupling.
- Clause 4.2.2.5: Passive safety.

²³ Professional competencies of staff required for the maintenance of units are not covered by this UTP, because they are covered by the regulation for the Entity in Charge of Maintenance.

²⁴ [OJ L 315, 03.12.2007, p.51](#)

²⁵ ~~[OJ L 315, 03.12.2007, p.51](#)~~

 OTIF	Uniform Technical Prescription (UTP)		UTP LOC&PAS	
	LOCOMOTIVES AND PASSENGER ROLLING STOCK		Page 145 of 272	
Status: DRAFT	Version: 03	TECH-20041 Annex	Original: EN	Date: 20.10.2020

- Clause 4.2.2.8: Staff and freight access doors.
- Clause 4.2.6.2.1: Slipstream effects on workers at trackside.
- Clause 4.2.7.2.2: Warning horn sound pressure.
- Clause 4.2.8.4: Protection against electrical hazards.
- Clause 4.2.9: Driver's cab.
- Clause 4.2.10: Fire safety and evacuation.

[Additional rules may apply in each Contracting State.](#)

4.8 Register of authorised types of vehicles

European register of authorised types of vehicles

(1) [\(reserved\)](#)

The characteristics of the rolling stock that must be recorded in the “European register of authorised types of vehicles” are listed in Commission Implementing Decision of 4 October 2011 on the European register of authorised types of railway vehicles²⁶.

(2) In accordance with

UTP GEN-C and the OTIF Uniform format of certificates,

Annex II of this decision on the European register and with [point \(a\) of Article 348\(32a\)](#) of Directive [\(EU\) 2016/797](#)~~2008/57/EC~~,

the values to be recorded for the parameters related to the technical characteristics of the rolling stock shall be those of the technical documentation accompanying the type examination certificate. Therefore, this

UTP

~~TSI~~

requires that the relevant characteristics are recorded in the technical documentation defined in the clause 4.2.12.

(3)

In accordance with Article 5 of the Decision referred to in the above point (1) of this clause 4.8, its application guide includes for each parameter a reference to the clauses of the technical specifications for interoperability that state the requirements for this parameter.

²⁶ [_Implementing Decision 2011/665/EU](#) (notified under document C (2011) 6974), OJ L 264, 08.10.2011, p.32

 OTIF	Uniform Technical Prescription (UTP)		UTP LOC&PAS	
	LOCOMOTIVES AND PASSENGER ROLLING STOCK		Page 146 of 272	
Status: DRAFT	Version: 03	TECH-20041 Annex	Original: EN	Date: 20.10.2020

4.9 Route compatibility checks before the use of authorised vehicles

The parameters of the subsystem “rolling stock — locomotives and passenger rolling stock” to be used by the railway undertaking, for the purpose of route compatibility check, are described in

UTP TCRC²⁷

Appendix D1 of Commission Implementing Regulation (EU) 2019/773²⁸.

5. INTEROPERABILITY CONSTITUENTS

5.1 Definition

- (1) Elements of Construction or “interoperability constituents” (ICs), are defined in Article 2(g) of ATMF.
- According to Article 2 (~~¶~~) of Directive [\(EU\) 2016/797/2008/57/EC](#), the interoperability constituents are “any elementary component, group of components, subassembly or complete assembly of equipment incorporated or intended to be incorporated into a subsystem upon which the interoperability of the rail system depends directly or indirectly.”

- (2) The concept of a “constituent” covers both tangible objects and intangible objects such as software.

- (3) ICs ~~Interoperability constituents (IC)~~

described in section 5.3 below are constituents:

- Whose specification refers to a requirement defined in section 4.2 of this

UTP.

~~TSI.~~

The reference to the relevant clause of the section 4.2 is given in section 5.3; it defines how the interoperability of the rail system depends on the particular constituent.

An IC shall comply with the technical specifications of this chapter whether it is assessed separately as an IC or is assessed as an integrated part of a subsystem.

Assessment of IC separate from the subsystem is not mandatory in the COTIF regulations, but Contracting States ~~or~~ ~~regional~~ ~~organisations~~²⁹ may require mandatory separate assessment according

²⁷- [UTP TCRC on Train composition and Route Compatibility Checks](#)

²⁸- [Commission Implementing Regulation \(EU\) 2019/773 of 16 May 2019 on the technical specification for interoperability relating to the operation and traffic management subsystem of the rail system within the European Union and repealing Decision 2012/757/EU \(OJ L 139 I, 27.5.2019, p. 5\).](#)

²⁹- In particular, compliance with EU law must be ensured when placing an IC on the market in the European Union.

 OTIF	Uniform Technical Prescription (UTP)		UTP LOC&PAS	
	LOCOMOTIVES AND PASSENGER ROLLING STOCK		Page 147 of 272	
Status: DRAFT	Version: 03	TECH-20041 Annex	Original: EN	Date: 20.10.2020

to the specification in sections 5.3 and 6.1 of this UTP. This possibility is without prejudice to section 6.3³⁰.

Separate assessment of an IC:

If the IC is in conformity with this UTP, as evidenced by the manufacturer in the form of a declaration of conformity or suitability for use according to section 6.1 of this UTP and chapter 2 of UTP GEN-D, the IC may be used in accordance with its defined area of use, in accordance with section 5.3, in all Contracting States.

Assessment of an IC integrated into a vehicle:

If the IC is assessed as a part of the subsystem, the assessment procedures for subsystems apply. The requirements are identical to those if the IC were to be assessed separately, i.e. those set out in sections 5.3 and 6.1.

When a requirement is

identified in section 5.3 as being

assessed at IC level, an assessment for the same requirement at sub-system level is not required.

- Whose specification may need additional requirements; such as interface requirements; these additional requirements are also specified in section 5.3.
- And whose assessment procedure, independently of the related subsystem is described in section 6.1.

- (4) The area of use of an interoperability constituent shall be stated and demonstrated as described for each of them in section 5.3.

5.2 Innovative solution

- (1) Innovative

As stated in article 10, innovative

solutions may require new specification and / or new assessment methods. Such specifications and assessment methods shall be developed by the process described in clause 6.1.5 whenever an innovative solution is envisaged for an IC.

³⁰ 6.3 permits, during a transitional period, the use of ICs produced before the entry into force of this UTP.

 OTIF	Uniform Technical Prescription (UTP)		UTP LOC&PAS	
	LOCOMOTIVES AND PASSENGER ROLLING STOCK		Page 148 of 272	
Status: DRAFT	Version: 03	TECH-20041 Annex	Original: EN	Date: 20.10.2020

5.3 Interoperability constituents specification

The Interoperability constituents are listed and specified below:

5.3.1 Automatic centre buffer coupler

An automatic coupler shall be designed and assessed for an area of use defined by:

- (1) The type of end coupling (mechanical and pneumatic interface of the head);

The 'type 10' automatic coupler shall be compliant with the specification referenced in Appendix J-1, index 66.

Note: other types of automatic couplers than type 10 are not considered as an IC (specification not publicly available).

- (2) The tensile and compressive forces it is capable of withstanding;
- (3) These characteristics shall be assessed at IC level.

5.3.2 Manual end coupling

A manual end coupling shall be designed and assessed for an area of use defined by:

- (1) The type of end coupling (mechanical interface).

The 'UIC type' shall be composed of buffer, draw gear and screw coupling system complying with the requirements of parts related to passenger coaches of the specification referenced in Appendix J-1, index 67 and the specification referenced in Appendix J-1, index 68; units other than coaches with manual coupling systems shall be fitted with a buffer, draw gear and screw coupling system complying with the relevant parts of the specification referenced in Appendix J-1, index 67 and the specification referenced in Appendix J-1, index 68 respectively.

Note: other types of manual end coupling are not considered as an IC (specification not publicly available).

- (2) The tensile and compressive forces it is capable of withstanding.
- (3) These characteristics shall be assessed at IC level.

5.3.3 Rescue couplers

A rescue coupler shall be designed and assessed for an area of use defined by:

- (1) The type of end coupling it is capable of being interfaced with;

The rescue coupler to be interfaced with the 'type 10' automatic coupler shall be compliant with the specification referenced in Appendix J-1, index 69.

Note: other types of rescue coupler are not considered as an IC (specification not publicly available)

- (2) The tensile and compressive forces it is capable of withstanding.
- (3) The way it is intended to be installed on the rescuing unit.

 OTIF	Uniform Technical Prescription (UTP)		UTP LOC&PAS	
	LOCOMOTIVES AND PASSENGER ROLLING STOCK		Page 149 of 272	
Status: DRAFT	Version: 03	TECH-20041 Annex	Original: EN	Date: 20.10.2020

(4) These characteristics and the requirements expressed in clause 4.2.2.2.4 of this

UTP

~~TSI~~

shall be assessed at IC level.

5.3.4 Wheels

A wheel shall be designed and assessed for an area of use defined by:

- (1) Geometrical characteristics: nominal tread diameter.
- (2) Mechanical characteristics: maximum vertical static force and maximum speed.
- (3) Thermo mechanical characteristics: maximum braking energy.
- (4) A wheel shall comply with the requirements on geometrical, mechanical and thermo mechanical characteristics defined in clause 4.2.3.5.2.2; these requirements shall be assessed at IC level.

5.3.4a Automatic variable gauge systems

- (1) An IC “automatic variable gauge system” shall be designed and assessed for an area of use defined by:
 - The track gauges the system is designed for.
 - The range of maximum static axle loads (corresponding to design mass under normal payload as defined in clause 4.2.2.10 of this UTP).
 - The range of nominal wheel tread diameters.
 - The maximum design speed of the unit.
 - The type(s) of track gauge changeover facility(ies) the system is designed for, including the nominal speed through the track gauge changeover facility(ies) and the maximum axial forces during the automatic gauge changeover process.
- (2) An automatic variable gauge system shall comply with the requirements set out in clause 4.2.3.5.2.3; these requirements shall be assessed at IC level as set out in clause 6.1.3.1a.

5.3.5 WSP (wheel slide protection system)

A IC “WSP system” shall be designed and assessed for an area of use defined by:

- (1) A brake system of pneumatic type.
Note: the WSP is not considered as an IC for other types of brake system such as hydraulic, dynamic and mixed braking systems, and this clause does not apply in that case.
- (2) The maximum operating speed.
- (3) A WSP system shall comply with the requirements related to the wheel slide protection system performance expressed in clause 4.2.4.6.2 of this

UTP.

~~TSI~~

 OTIF	Uniform Technical Prescription (UTP)		UTP LOC&PAS	
	LOCOMOTIVES AND PASSENGER ROLLING STOCK		Page 150 of 272	
Status: DRAFT	Version: 03	TECH-20041 Annex	Original: EN	Date: 20.10.2020

The wheel rotation monitoring system may be included as an option.

5.3.6 Head lamps

- (1) A head lamp is designed and assessed without any limitation concerning its area of use.
- (2) A head lamp shall comply with requirements concerning the colour and the luminous intensity defined in clause 4.2.7.1.1. These requirements shall be assessed at IC level.

5.3.7 Marker lamps

- (1) A marker lamp is designed and assessed without any limitation concerning its area of use.
- (2) A marker lamp shall comply with requirements concerning the colour and the luminous intensity defined in clause 4.2.7.1.2. These requirements shall be assessed at IC level.

5.3.8 Tail lamps

- (1) A tail lamp shall be designed and assessed for an area of use: fixed lamp or portable lamp.
- (2) A tail lamp shall comply with the requirements concerning the colour and the luminous intensity defined in clause 4.2.7.1.3. These requirements shall be assessed at IC level.
- (3) For portable tail lamps, the interface for attachment on the vehicle shall be in accordance with the Appendix E of the

UTP

TSI

“freight wagons”.

5.3.9 Horns

- (1) A horn shall be is designed and assessed for an area of use defined by its sound pressure level on a reference vehicle (or reference integration); this characteristic may be affected by the integration of the horn in a particular vehicle.
- (2) A horn shall comply with the requirements concerning the soundings of signals defined in clause 4.2.7.2.1. These requirements shall be assessed at IC level.

5.3.10 Pantograph

A pantograph shall be designed and assessed for an area of use defined by:

- (1) The type of voltage system(s), as defined in clause 4.2.8.2.1.
In case it is designed for different voltage systems, the various sets of requirements shall be taken into account.
- (2) One of the 3 pantograph head geometries specified in clause 4.2.8.2.9.2.
- (3) The current capacity, as defined in clause 4.2.8.2.4.

 OTIF	Uniform Technical Prescription (UTP)		UTP LOC&PAS	
	LOCOMOTIVES AND PASSENGER ROLLING STOCK		Page 151 of 272	
Status: DRAFT	Version: 03	TECH-20041 Annex	Original: EN	Date: 20.10.2020

- (4) The maximum current at standstill per contact wire of the overhead contact line for DC systems.
Note: the maximum current at standstill, as defined in clause 4.2.8.2.5., shall be compatible with the value above, considering the characteristics of the overhead contact line (1 or 2 contact wires).
- (5) The maximum operating speed: assessment of the maximum operating speed shall be performed as defined in clause 4.2.8.2.9.6.
- (6) Range of height for dynamic behaviour: standard, and/or for 1520 mm or 1524 mm track gauge systems.
- (7) The requirements listed above shall be assessed at IC level.
- (8) The working range in height of pantograph specified in clause 4.2.8.2.9.1.2, the pantograph head geometry specified in clause 4.2.8.2.9.2, the pantograph current capacity specified in clause 4.2.8.2.9.3, the pantograph static contact force specified in clause 4.2.8.2.9.5 and the dynamic behaviour of the pantograph itself specified in clause 4.2.8.2.9.6 shall also be assessed at IC level.

5.3.11 Contact strips

- (1) The contact strips are the replaceable parts of the pantograph head which are in contact with the contact wire.

Contacts strips shall be designed and assessed for an area of use defined by:

- (2) Their geometry, as defined in clause 4.2.8.2.9.4.1.
- (3) The material of the contact strips, as defined in clause 4.2.8.2.9.4.2.
- (4) The type of voltage system(s), as defined in clause 4.2.8.2.1.
- (5) The current capacity, as defined in clause 4.2.8.2.4.
- (6) The maximum current at standstill for DC systems, as defined in clause 4.2.8.2.5.
- (7) The requirements listed above shall be assessed at IC level.

5.3.12 Main circuit breaker

A main circuit breaker shall be designed and assessed for an area of use defined by:

- (1) The type of voltage system(s), as defined in clause 4.2.8.2.1.
- (2) The current capacity, as defined in clause 4.2.8.2.4 (maximum current).
- (3) The requirements listed above shall be assessed at IC level.
- (4) The tripping shall be as specified in the specification referenced in Appendix J-1, index 70 (see clause 4.2.8.2.10 of this

UTP);

TSD); it shall be assessed at the IC level.

 OTIF	Uniform Technical Prescription (UTP)		UTP LOC&PAS	
	LOCOMOTIVES AND PASSENGER ROLLING STOCK		Page 152 of 272	
Status: DRAFT	Version: 03	TECH-20041 Annex	Original: EN	Date: 20.10.2020

5.3.13 Driver's seat

- (1) A driver's seat shall be is designed and assessed for an area of use defined by the range of possible adjustments in height and longitudinal position.
- (2) A driver's seat shall comply to the requirements specified at component level in the clause 4.2.9.1.5. These requirements shall be assessed at IC level.

5.3.14 Toilet discharge connection

- (1) A toilet discharge connection is designed and assessed without any limitation concerning its area of use.
- (2) A toilet discharge connection shall comply with requirements concerning the dimensions as defined in clause 4.2.11.3. These requirements shall be assessed at IC level.

5.3.15 Inlet connection for water tanks

- (1) A inlet connection for water tanks is designed and assessed without any limitation concerning its area of use.
- (2) A inlet connection for water tanks shall comply with requirements concerning the dimensions as defined in clause 4.2.11.5. These requirements shall be assessed at IC level.

6. ASSESSMENT OF CONFORMITY OR SUITABILITY FOR USE

AND 'EC' VERIFICATION

- (1) Modules for the assessment procedures for the verification of elements of construction are described in the UTP GEN-D. procedures for assessment of conformity, suitability for use and EC verification are described in the Commission Decision 2010/713/EU.

6.1 Elements of construction (IC)

Interoperability constituent (IC)

6.1.1 Conformity assessment

- (1) In accordance with UTP GEN-D, Contracting States may require the mandatory separate assessment of ICs. If not required by the Contracting State, separate assessment of ICs may be carried out on a voluntary basis. In the case of separate IC assessment, the manufacturer bears full responsibility for the UTP compliance of the product within its specified area of use. An EC declaration of conformity or suitability for use, in accordance with Article 103(1) and Annex IV of Directive (EU) 2016/7972008/57/EC, shall be drawn up by the manufacturer or his authorised representative established in the Union before placing a interoperability constituent on the market.

 OTIF	Uniform Technical Prescription (UTP)		UTP LOC&PAS	
	LOCOMOTIVES AND PASSENGER ROLLING STOCK		Page 153 of 272	
Status: DRAFT	Version: 03	TECH-20041 Annex	Original: EN	Date: 20.10.2020

- (2) In case of separate IC assessment, the assessment | The assessment of conformity or suitability for use of an interoperability constituent

shall be performed according to the prescribed module(s) of that particular constituent specified in clause 6.1.2 of this

UTP.

~~TSI~~

- (3) [In case of a specific case applicable to a component defined as interoperability constituent in section 5.3 of this UTP, the corresponding requirement can be part of the verification at interoperability constituent level only in the case where the component remains compliant to the chapters 4 and 5 of this UTP, and where the specific case does not refer to a national rule \(i.e. additional requirement compatible with the core UTP and fully specified in the UTP\).](#)

[In other cases, the verification shall be made at subsystem level; when a national rule applies to a component, the concerned Contracting State may define relevant applicable conformity assessment procedures.](#)

6.1.2 Application of modules

Assessment procedures for the verification of elements of construction

~~Modules for EC certification of conformity of interoperability constituents~~

Module CA	Internal production control	
Module CA1	Internal production control plus product verification by individual examination	
Module CA2	Internal production control plus product verification at random intervals	
Module CB	Type examination	EC-Type examination
Module CC	Conformity to type based on internal production control	
Module CD	Conformity to type based on quality management system of the production process	
Module CF	Conformity to type based on product verification	
Module CH	Conformity based on full quality management system	
Module CH1	Conformity based on full quality management system plus design examination	
Module CV	Type validation by in service experience (Suitability for use)	

- (1) In the case of separate IC assessment, the manufacturer | The manufacturer or his authorised representative established within the European Union

shall choose one of the modules or module combinations indicated in the following table for the constituent to be assessed:



Point	Constituents to be assessed	Module CA	Module CA1 or CA2 ³¹	Module CB+CC	Module CB+CD	Module CB+CF	Module CH	Module CH1
5.3.1	Automatic centre buffer coupler		X(*)		X	X	X(*)	X
5.3.2	Manual end coupling		X(*)		X	X	X(*)	X
5.3.3	Towing coupler for rescue		X(*)		X	X	X(*)	X
5.3.4	Wheel		X(*)		X	X	X(*)	X
5.3.4a	Automatic variable gauge systems		X(*)		X	X	X(*)	X
5.3.5	Wheel slide protection system		X(*)		X	X	X(*)	X
5.3.6	Head lamp		X(*)	X	X		X(*)	X
5.3.7	Marker lamp		X(*)	X	X		X(*)	X
5.3.8	Tail lamp		X(*)	X	X		X(*)	X
5.3.9	Horns		X(*)	X	X		X(*)	X
5.3.10	Pantograph		X(*)		X	X	X(*)	X
5.3.11	Pantograph contact strips		X(*)		X	X	X(*)	X
5.3.12	Main circuit breaker		X(*)		X	X	X(*)	X
5.3.13	Driver's seat		X(*)		X	X	X(*)	X
5.3.14	Toilet discharge connection	X		X			X	
5.3.15	Inlet connection for water tanks	X		X			X	

(*) Modules CA1, CA2 or CH may be used only in the case of products manufactured according to a design developed and already used to place products on the

³¹ Modules CA1, CA2 or CH may be used only in the case of products manufactured according to a design developed and already used to place products on the market before the entry into force of relevant UTP applicable to those products, provided that the manufacturer demonstrates to the assessing entity that design review and type examination were performed for previous applications under comparable conditions, and are in conformity with the requirements of this UTP; this demonstration shall be documented, and is considered as providing the same level of proof as module CB or design examination according to module CH1.

 OTIF	Uniform Technical Prescription (UTP)		UTP LOC&PAS	
	LOCOMOTIVES AND PASSENGER ROLLING STOCK		Page 155 of 272	
Status: DRAFT	Version: 03	TECH-20041 Annex	Original: EN	Date: 20.10.2020

market before the entry into force of relevant TSI applicable to those products, provided that the manufacturer demonstrates to the notified body that design review and type examination were performed for previous applications under comparable conditions, and are in conformity with the requirements of this TSI; this demonstration shall be documented, and is considered as providing the same level of proof as module CB or design examination according to module CH1.

- (2) Where a particular procedure shall be used for the assessment, in addition to the requirements expressed in the clause 4.2 of this

UTP,

~~TSI~~

this is specified in the clause 6.1.3 below.

6.1.3 Particular assessment procedures for interoperability constituents

6.1.3.1 Wheels (clause 5.3.4)

- (1) The mechanical characteristics of the wheel shall be proven by mechanical strength calculations, taking into account three load cases: straight track (centred wheelset), curve (flange pressed against the rail), and negotiating of points and crossings (inside surface of flange applied to the rail), as specified in the specification referenced in Appendix J-1, index 71, clauses 7.2.1 and 7.2.2.
- (2) For forged and rolled wheels, the decision criteria are defined in the specification referenced in Appendix J-1, index 71, clause 7.2.3; where the calculation show values beyond the decision criteria, a bench test according to the specification referenced in Appendix J-1, index 71, clause 7.3 is required to be performed to demonstrate compliance.
- (3) Other types of wheels are permitted for vehicles restricted to national use. In that case the decision criteria and the fatigue stress criteria shall be specified in national rules. Those national rules shall be notified by Member States.
- (4) The assumption of the load conditions for the maximum vertical static force shall be explicitly stated in the technical documentation as set out in clause 4.2.12 of this

UTP.

~~TSI~~

Thermo-mechanical behaviour:

- (5) If the wheel is used to brake a unit with blocks acting on the wheel running surface, the wheel shall be thermo mechanically proven by taking into account the maximum braking energy foreseen. The wheel shall be subject to a conformity assessment in accordance with the specification referenced in Appendix J-1, index 71, clause 6 in order to check that the lateral displacement of the rim during braking and the residual stress are within tolerance limits specified utilising the decision criteria specified.

Verification of the wheels:

 OTIF	Uniform Technical Prescription (UTP)		UTP LOC&PAS	
	LOCOMOTIVES AND PASSENGER ROLLING STOCK		Page 156 of 272	
Status: DRAFT	Version: 03	TECH-20041 Annex	Original: EN	Date: 20.10.2020

- (6) A verification procedure shall exist to ensure at the production phase that no defects may detrimentally affect safety due to any change in the mechanical characteristics of the wheels.
- The tensile strength of the material in the wheel, the hardness of the running surface, the fracture toughness, the resistance to impact, the material characteristics and the material cleanliness shall be verified.
- The verification procedure shall specify the batch sampling used for each characteristic to be verified.
- (7) Other conformity assessment method for wheels is allowed under the same conditions as for wheelsets; these conditions are described in clause 6.2.3.7.
- (8) In case of innovative design for which the manufacturer has no sufficient return of experience, the wheel should be subject to an assessment of suitability for use (module CV; see also clause 6.1.6).

6.1.3.1a Automatic variable gauge system (clause 5.3.4a)

- (1) The assessment procedure shall be based on a validation plan covering all aspects mentioned in clauses 4.2.3.5.3 and 5.3.4a.
- (2) The validation plan shall be consistent with the safety analysis required in clause 4.2.3.5.3 and shall define the assessment needed in all the following different phases:
- Design review.
 - Static tests (bench tests and integration in the running gear/unit tests).
 - Test on track gauge changeover facility(ies), representative of in-service conditions.
 - On-track tests, representative of in-service conditions.
- (3) Regarding the demonstration of compliance to points (5) of clause 4.2.3.5.3, the assumptions considered for the safety analysis related to the vehicle the system is intended to be integrated in, and related to the mission profile of that vehicle, shall be clearly documented.
- (4) The automatic variable gauge system may be subject to an assessment of suitability for use (module CV; see also clause 6.1.6).
- (5) The certificate delivered by the Assessing entity in charge of the conformity assessment shall include both the conditions for use as per clause 5.3.4a (1) and the type(s) and operating conditions of the track gauge changeover facility(ies) the automatic variable gauge system has been assessed for.

6.1.3.2 Wheel slide protection system (clause 5.3.5)

- (1) The wheel slide protection system shall be verified according to the methodology defined in the specification referenced in Appendix J-1, index 72, clause 5; when reference is made to the clause 6.2 of the same specification “overview of required test programmes”, only the clause 6.2.3 applies, and it applies to all WSP systems.
- (2) In case of innovative design for which the manufacturer has no sufficient return of experience, the wheel slide protection system should be subject to an assessment of suitability for use (module CV; see also clause 6.1.6).

 OTIF	Uniform Technical Prescription (UTP)		UTP LOC&PAS	
	LOCOMOTIVES AND PASSENGER ROLLING STOCK		Page 157 of 272	
Status: DRAFT	Version: 03	TECH-20041 Annex	Original: EN	Date: 20.10.2020

6.1.3.3 Head lamps (clause 5.3.6)

- (1) The colour of headlamps shall be tested in accordance with the specification referenced in Appendix J-1, index 73, clause 6.3.
- (2) The luminous intensity of headlamps shall be tested in accordance with the specification referenced in Appendix J-1, index 73, clause 6.4.

6.1.3.4 Marker lamps (clause 5.3.7)

- (1) The colour of marker lamps and the spectral radiation distribution of light from marker lamps shall be tested in accordance with the specification referenced in Appendix J-1, index 74, clause 6.3.
- (2) The luminous intensity of marker lamps shall be tested in accordance with the specification referenced in Appendix J-1, index 74, clause 6.4.

6.1.3.5 Tail lamps (clause 5.3.8)

- (1) The colour of tail lamps shall be tested in accordance with the specification referenced in Appendix J-1, index 75, clause 6.3.
- (2) The luminous intensity of tail lamps shall be tested in accordance with the specification referenced in Appendix J-1, index 75, clause 6.4.

6.1.3.6 Horn (clause 5.3.9)

- (1) Soundings of the warning horn shall be measured and verified in accordance with the specification referenced in Appendix J-1, index 76, clause 6.
- (2) Sound pressure levels of the warning horn on a reference vehicle shall be measured and verified in accordance with the specification referenced in Appendix J-1, index 76, clause 6.

6.1.3.7 Pantograph (clause 5.3.10)

- (1) For pantographs for DC systems, the maximum current at standstill per contact wire shall be verified in the following conditions:
 - The pantograph shall be in contact with 1 copper contact wire.
 - The pantograph shall apply a static contact force as defined in the specification referenced in Appendix J-1, index 77.
 - and the temperature of the contact point monitored continuously during a test of 30 minutes shall not exceed the values given in the specification referenced in Appendix J-1, index 78.
- (2) For all pantographs, the static contact force shall be verified in accordance with the specification referenced in Appendix J-1, index 79.
- (3) The dynamic behaviour of the pantograph regarding current collection shall be assessed by simulation according to the specification referenced in Appendix J-1, index 80.

The simulations shall be made using at least two different types of overhead contact line; data for simulation shall correspond to sections of lines

 OTIF	Uniform Technical Prescription (UTP)		UTP LOC&PAS	
	LOCOMOTIVES AND PASSENGER ROLLING STOCK		Page 158 of 272	
Status: DRAFT	Version: 03	TECH-20041 Annex	Original: EN	Date: 20.10.2020

on which the unit is intended to be operated. The Competent Authorities of the relevant Contracting States shall ensure that the necessary information is made available to the applicant,

recorded as TSI compliant in the register of infrastructure (EC declaration of conformity, or declaration according to recommendation 2011/622/EU)

for the appropriate speed and supply system, up to the design speed of the proposed IC pantograph.

It is permitted to perform the simulation using types of overhead contact line that are under the process of IC certification or declaration according to recommendation 2011/622/EU, provided that they fulfil the other requirements of ENE TSI.

The simulated current collection quality shall be in accordance with clause 4.2.8.2.9.6 for uplift, mean contact force and standard deviation for each of the overhead contact lines.

If the simulation results are acceptable, a site dynamic test shall be made using a representative section of one of the two types of overhead contact line used in the simulation.

The interaction characteristics shall be measured in accordance with the specification referenced in Appendix J-1, index 81.

The tested pantograph shall be mounted on a rolling stock producing a mean contact force within the upper and lower limits as required by clause 4.2.8.2.9.6 up to the design speed of the pantograph. The tests shall be conducted in both directions of travel.

For pantographs intended to be operated on the 1435 mm and 1668 mm track gauge systems, the tests shall include track sections with low contact wire height (defined as between 5.0 to 5.3 m) and track sections with high contact wire height (defined as between 5.5 to 5.75 m).

For pantographs intended to be operated on the 1520 mm and 1524 mm track gauge systems, the tests shall include track sections with contact wire height between 6.0 to 6.3 m.

The tests shall be performed for a minimum of 3 speed increments up to and including the design speed of the tested pantograph.

The interval between successive tests shall be no greater than 50 km/h.

The measured current collection quality shall be in accordance with clause 4.2.8.2.9.6 for uplift, and either mean contact force and standard deviation or percentage of arcing.

If all the assessments above are passed successfully, the tested pantograph design shall be considered as compliant to the

UTP

~~TSI~~

regarding quality of current collection.

For the use of a pantograph

which is UTP compliant

holding an EC declaration of verification

on various designs of rolling stock, additional tests required at rolling stock level regarding quality of current collection are specified in clause 6.2.3.20.

 OTIF	Uniform Technical Prescription (UTP)		UTP LOC&PAS	
	LOCOMOTIVES AND PASSENGER ROLLING STOCK		Page 159 of 272	
Status: DRAFT	Version: 03	TECH-20041 Annex	Original: EN	Date: 20.10.2020

6.1.3.8 Contact strips (clause 5.3.11)

- (1) Contact strips shall be verified as specified in the specification referenced in Appendix J-1, index 82.
- (2) Contact strips, being replaceable parts of the pantograph head, shall be verified once at the same time as a pantograph (see clause 6.1.3.7) regarding the quality of current collection.
- (3) In case of use of a material for which the manufacturer has no sufficient return of experience, the contact strip should be subject to an assessment of suitability for use (module CV; see also clause 6.1.6).

6.1.4 Project phases where assessment is required

- (1) It is detailed in Appendix H of this

UTP

TSI

in which phases of the project an assessment shall be done for the requirements applicable to the interoperability constituent:

- Design and development phase:
 - Design review and/or design examination.
 - Type test: test to verify the design, if and as defined in the section 4.2.
- Production phase: routine test to verify the conformity of production.

The entity in charge of the assessment of the routine tests is determined according to the assessment module chosen.

- (2) Annex H is structured according to section 4.2; the requirements and their assessment applicable to the interoperability constituent are identified in section 5.3 by reference to certain clauses of section 4.2; where relevant, a reference to a sub-clause of clause 6.1.3 above is also given.

6.1.5 Innovative solutions

- (1) If an innovative solution

(as defined in Article 10)

is proposed for an interoperability constituent,

the manufacturer shall apply the procedure described in section 6.2.5.

the manufacturer or his authorised representative established within the European Union shall apply the procedure described in article 10.

6.1.6 Assessment of suitability for use

- (1) Assessment of suitability for use according to the type validation of in service experience procedure (module CV) may be part of the assessment procedure for the following elements of construction ~~interoperability constituent in case the manufacturer has no sufficient return of experience for the proposed design:~~

- Wheels (see clause 6.1.3.1).

 OTIF	Uniform Technical Prescription (UTP)		UTP LOC&PAS	
	LOCOMOTIVES AND PASSENGER ROLLING STOCK		Page 160 of 272	
Status: DRAFT	Version: 03	TECH-20041 Annex	Original: EN	Date: 20.10.2020

- [Automatic variable gauge system \(see clause 6.1.3.1a\).](#)
- Wheel slide protection system (see clause 6.1.3.2).
- Contact strips (see clause 6.1.3.8).

- (2) Prior to commencing in service tests, a suitable module (CB or CH1) shall be used to certify the design of the constituent.
- (3) The in service tests shall be organised on proposal from the manufacturer, who has to obtain an agreement with a railway undertaking for its contribution to such assessment.

6.2 Rolling stock subsystem

6.2.1 ~~OTIF~~-verification [procedure](#) (general)

EC verification (general)

- (1) The OTIF procedure for granting technical certificates is set out in ATMF Article 10.

A Contracting State which is also a member of the European Union shall apply European law concerning EC Declarations of verification.

The EC verification procedures to be applied to the rolling stock subsystem are described in Article 15~~8~~ and Annex ~~IV~~ of Directive ~~(EU) 2016/797~~[2008/57/EC](#).

- (2) The UTP verification procedure

~~The EC verification procedure~~

of a rolling stock unit shall be performed according to the prescribed modules(s) specified in clause 6.2.2 of this

UTP.

~~TSI~~

- (3) When a first step assessment covering the design stage or the design and production stages is applied for by the applicant, the

assessing entity

~~notified body~~

of his choice shall issue the Intermediate Statement Verification (ISV) and the

UTP certificate of verification.

EC declaration of Intermediate Sub-system conformity shall be drawn up.

6.2.2 Application of modules

Assessment procedures for the verification of elements of construction

~~Modules for EC certification of conformity of interoperability constituents~~

<i>Module SB</i>	Type examination	<i>EC-Type Examination</i>
Module SD	Quality management system of the production process	EC verification based on quality management system of the production process
Module SF	Verification based on product verification	EC verification based on product verification

 OTIF	Uniform Technical Prescription (UTP)		UTP LOC&PAS	
	LOCOMOTIVES AND PASSENGER ROLLING STOCK		Page 161 of 272	
Status: DRAFT	Version: 03	TECH-20041 Annex	Original: EN	Date: 20.10.2020

Module SH1	Verification based on full quality management system plus design examination	EC verification based on full quality management system plus design examination
------------	--	---

- (1) The applicant shall choose one of the following combinations of modules: (SB+SD) or (SB+SF) or (SH1) for each concerned subsystem (or part of subsystem).

The assessment shall then be performed according to the combination of modules chosen.

- (2) Where several

verifications

EC verifications

(e.g. against several

UTP

~~TSI~~

addressing the same sub-system) require verification based on the same production assessment (module SD or SF), it is allowed to combine several SB module assessments with one production module assessment (SD or SF). In this case, ISVs shall be issued for the design and development phases according to module SB.

- (3) The validity of the type or design examination certificate shall be indicated in accordance with the provisions for phase B of clause 7.1.3

of this UTP.

Rules related to EC verification', of this TSI.

- (4) Where a particular procedure shall be used for the assessment, in addition to the requirements expressed in the clause 4.2 of this

UTP,

~~TSI~~

this is specified in the clause 6.2.3 below.

6.2.3 Particular assessment procedures for subsystems

6.2.3.1 Load conditions and weighed mass (clause 4.2.2.10)

- (1) Weighed mass shall be measured, for a load condition corresponding to “design mass in working order” with the exception of consumables for which there is no imposition (for example “dead mass” is acceptable).

- (2) It is permissible to derive the other load conditions by calculation.

- (3) Where a vehicle is declared as conformant to a type (in accordance with clauses 6.2.2 and 7.1.3 of this

UTP):

~~TSI~~:

- the weighed total vehicle mass in the load condition “design mass in working order” shall not exceed by more than 3% the declared total vehicle mass for that type which is reported in the type or design examination certificate of

UTP verification,

EC verification,

 OTIF	Uniform Technical Prescription (UTP)		UTP LOC&PAS	
	LOCOMOTIVES AND PASSENGER ROLLING STOCK		Page 162 of 272	
Status: DRAFT	Version: 03	TECH-20041 Annex	Original: EN	Date: 20.10.2020

and in the technical documentation described in clause 4.2.12.

- additionally, for unit of maximum design speed higher than or equal to 250 km/h the mass per axle for the load condition “design mass under normal payload” shall not exceed by more than 4 % the declared mass per axle for the same load condition.

6.2.3.2 Wheel load (clause 4.2.3.2.2)

- (1) The wheel load shall be measured considering the load condition “design mass in working order” (with same exception as in clause 6.2.3.1 above).

6.2.3.3 Safety against derailment running on twisted track (Clause 4.2.3.4.1)

- (1) The demonstration of conformity shall be carried out in accordance with one of the methods specified in the specification referenced in Appendix J-1, index 83 ~~as amended by the technical document referenced in Appendix J.2, index 2.~~
- (2) For units intended to be operated on 1520 mm system, alternative methods for conformity assessment are allowed.

6.2.3.4 Running dynamic behaviour – technical requirements (Clause 4.2.3.4.2 a)

- (1) For units designed to be operated on 1435 mm or 1524 mm or 1668 mm system, the demonstration of conformity shall be carried out in accordance with the specification referenced in Appendix J-1, index 84, clause ~~7~~5.
- (2) The parameters described in clauses 4.2.3.4.2.1 and 4.2.3.4.2.2 shall be assessed using criteria defined in the specification referenced in Appendix J-1, index 84.

~~The conditions for the assessment in accordance with the specification referenced in Appendix J-1, index 84 shall be amended as per technical document referenced in Appendix J-2, index 2.~~

6.2.3.5 Conformity assessment for safety requirements

The demonstration of compliance with the safety requirements expressed in the clause 4.2 shall be performed as follows:

- (1) The scope of this assessment shall be strictly limited to the rolling stock design, considering that operation, test and maintenance are performed according to the rules defined by the applicant (as described in the technical file).

Notes:

- When defining the test and maintenance requirements, the safety level to be met has to be taken into account by the applicant (consistency); the demonstration of compliance covers also test and maintenance requirements.
 - Other sub-systems and human factors (errors) shall not be considered.
- (2) All assumptions considered for the mission profile shall be clearly documented in the demonstration.
 - (3) The compliance with the safety requirements that are specified in clauses 4.2.3.4.2, [4.2.3.5.3](#), 4.2.4.2.2, 4.2.5.3.5, 4.2.5.5.8 and 4.2.5.5.9 in terms of level of severity/consequences associated to hazardous failure scenarios shall be demonstrated by one of the two following methods:

 OTIF	Uniform Technical Prescription (UTP)		UTP LOC&PAS	
	LOCOMOTIVES AND PASSENGER ROLLING STOCK		Page 163 of 272	
Status: DRAFT	Version: 03	TECH-20041 Annex	Original: EN	Date: 20.10.2020

1. Application of a harmonised risk acceptance criterion associated to the severity specified in the clause 4.2 (e.g. “fatalities” for emergency braking.).

The applicant may choose to use this method, provided that there is an available harmonized risk acceptance criterion defined in the

UTP GEN-G Risk Evaluation and Assessment.	CSM on Risk Assessment and its amendments (Commission Implementing Regulation (EU) No 402/2013 ³²).
---	--

The applicant shall demonstrate compliance with the harmonised criterion by applying

Annex I-3 of the UTP GEN-G.	Annex I-3 of the CSM on RA.
-----------------------------	-----------------------------

The following principles (and their combinations) may be used for the demonstration: similarity with reference system(s); application of codes of practice; application of an explicit risk estimation (e.g. probabilistic approach).

The applicant shall designate the body for the assessment of the demonstration he will provide: the

assessing entity	notified body
------------------	--------------------------

selected for the RST sub-system or an **CSM** assessment body as defined in the

UTP GEN-G.	CSM on RA.
------------	-----------------------

The demonstration shall be recognized in all

Contracting States.	Member States.
---------------------	---------------------------

or

2. Application of a risk evaluation and assessment in accordance with the

UTP GEN-G,	CSM on RA,
------------	-----------------------

in order to define the risk acceptance criterion to be used, and demonstrate compliance to this criterion.

The applicant may choose to use this method in any case.

The applicant shall designate the **CSM** assessment body for the assessment of the demonstration he will provide, as defined in the

UTP GEN-G.	CSM on RA.
------------	-----------------------

A safety assessment report shall be provided in compliance with the requirements defined in the

³² [Commission Implementing Regulation \(EU\) No 402/2013 of 30 April 2013 on the common safety method for risk evaluation and assessment and repealing Regulation \(EC\) No 352/2009 as referred to in Article 6\(3\)\(a\) of Directive 2004/49/EC of the European Parliament and of the Council \(OJ L 121, 3.5.2013, p. 8\)](#) ~~Commission Regulation (EC) No 352/2009.~~

 OTIF	Uniform Technical Prescription (UTP)		UTP LOC&PAS	
	LOCOMOTIVES AND PASSENGER ROLLING STOCK		Page 164 of 272	
Status: DRAFT	Version: 03	TECH-20041 Annex	Original: EN	Date: 20.10.2020

UTP GEN-G.

~~CSM-on-RA.~~

and its amendments.

The safety assessment report shall be taken into account by the

Competent Authority in the Contracting State concerned,

~~Authorising entity National Safety Authority in the concerned Member State,~~

in accordance with Section 2.5.6 of Annex I and Article 15(2) of the

UTP GEN-G.

~~CSM-on-RA.~~

~~In the case of additional authorisations for placing in service of vehicles, Article 15 (5) of the~~

~~UTP GEN-G~~

~~CSM-on-RA~~

~~applies for the recognition of the safety assessment report in other~~

~~Contracting~~

~~Member~~

~~States.~~

(4) For each

UTP

~~TSI~~

clause listed in point (3) above, the relevant documents accompanying the

Certificate of Operation (e.g. UTP certificate of verification or safety assessment report)

~~EC declaration of verification (e.g. EC certificate issued by the notified body or safety assessment report)~~

shall explicitly mention the ‘used method’ (‘1’ or ‘2’); in case of method ‘2’, they shall also mention the ‘used risk acceptance criterion’.

6.2.3.6 Design values for new wheel profiles (clause 4.2.3.4.3.1)

(1) For units designed to be operated on 1435 mm track gauge system, the wheel profile and the distance between active faces of the wheels (Dimension SR in Figure 1, § 4.2.3.5.2.1) shall be selected to ensure that the equivalent conicity limit set out in table 11 below is not exceeded when the designed wheelset is combined with each of the sample of track parameters as specified in table 12 below.

The evaluation of the equivalent conicity is set out in the ~~specification technical document~~ referenced in Appendix J-12, index 1072.

 OTIF	Uniform Technical Prescription (UTP)		UTP LOC&PAS	
	LOCOMOTIVES AND PASSENGER ROLLING STOCK		Page 165 of 272	
Status: DRAFT	Version: 03	TECH-20041 Annex	Original: EN	Date: 20.10.2020

Table 11. Equivalent conicity design limit values

Maximum vehicle operating speed (km/h)	Equivalent conicity limit values	Test conditions (see Table 12)
≤ 60	N/A	N/A
>60 and <190	0.30	All
≥190 and ≤230	0.25	1,2,3,4,5 and 6
>230 and ≤280	0.20	1,2,3,4,5 and 6
>280 and ≤300	0.10	1,3,5 and 6
>300	0.10	1 and 3

*Table 12. Track test conditions for equivalent conicity representative of the network.
All rail sections defined in the specification referenced in Appendix J-1, index 85.*

Test condition no.	Rail head profile	Rail inclination	Track gauge
1	rail section 60 E 1	1 in 20	1435 mm
2	rail section 60 E 1	1 in 40	1435 mm
3	rail section 60 E 1	1 in 20	1437 mm
4	rail section 60 E 1	1 in 40	1437 mm
5	rail section 60 E 2	1 in 40	1435 mm
6	rail section 60 E 2	1 in 40	1437 mm
7	Rail section 54 E1	1 in 20	1435 mm
8	Rail section 54 E1	1 in 40	1435 mm
9	Rail section 54 E1	1 in 20	1437 mm
10	Rail section 54 E1	1 in 40	1437 mm

The requirements of this clause are deemed to have been met by wheelsets having unworn S1002 or GV 1/40 profiles, as defined in the specification referenced in Appendix J-1, index 86 with spacing of active faces between 1420 mm and 1426 mm.

- (2) For units designed to be operated on 1524 mm track gauge system, the wheel profile and the distance between active faces of the wheels shall be selected with the following inputs:

 OTIF	Uniform Technical Prescription (UTP)		UTP LOC&PAS	
	LOCOMOTIVES AND PASSENGER ROLLING STOCK		Page 166 of 272	
Status: DRAFT	Version: 03	TECH-20041 Annex	Original: EN	Date: 20.10.2020

Table 13. Equivalent conicity design limit values

Maximum vehicle operating speed (km/h)	Equivalent conicity limit values	Test conditions (see table 14)
≤ 60	N/A	N/A
>60 and ≤190	0.30	1, 2, 3, 4, 5 and 6
>190 and ≤230	0.25	1, 2, 3 and 4
>230 and ≤280	0.20	1, 2, 3 and 4
>280 and ≤300	0.10	3, 4, 7 and 8
>300	0.10	7 and 8

Table 14. Track test conditions for equivalent conicity.

All rail sections defined in the specification referenced in Appendix J-1, index 85

Test condition no.	Rail head profile	Rail inclination	Track gauge
1	rail section 60 E 1	1 in 40	1524 mm
2	rail section 60 E 1	1 in 40	1526 mm
3	rail section 60 E 2	1 in 40	1524 mm
4	rail section 60 E 2	1 in 40	1526 mm
5	Rail section 54 E1	1 in 40	1524 mm
6	Rail section 54 E1	1 in 40	1526 mm
7	rail section 60 E 1	1 in 20	1524 mm
8	rail section 60 E 1	1 in 20	1526 mm

The requirements of this clause are deemed to have been met by wheelsets having unworn S1002 or GV 1/40 profiles, as defined in the specification referenced in Appendix J-1, index 86, with spacing of active faces distance 1510.

- (3) For units designed to be operated on 1668 mm track gauge system, equivalent conicity limits set in the table 15 shall not be exceeded when the designed wheelset is modelled passing over the representative sample of track test conditions as specified in table 16:

 OTIF	Uniform Technical Prescription (UTP)		UTP LOC&PAS	
	LOCOMOTIVES AND PASSENGER ROLLING STOCK		Page 167 of 272	
Status: DRAFT	Version: 03	TECH-20041 Annex	Original: EN	Date: 20.10.2020

Table 15. Equivalent conicity design limit values

Maximum vehicle operating speed (km/h)	Equivalent conicity limit values	Test conditions (see table 16)
≤ 60	N/A	N/A
>60 and <190	0.30	All
≥190 and ≤ 230	0.25	1 and 2
>230 and ≤280	0.20	1 and 2
>280 and ≤300	0.10	1 and 2
>300	0.10	1 and 2

*Table 16. Track test conditions for equivalent conicity.
All rail sections defined in the specification referenced in Appendix J-1, index 85.*

Test condition No.	Rail head profile	Rail inclination	Track gauge
1	Rail section 60 E 1	1 in 20	1668 mm
2	Rail section 60 E 1	1 in 20	1670 mm
3	Rail section 54 E1	1 in 20	1668 mm
4	Rail section 54 E1	1 in 20	1670 mm

The requirements of this clause are deemed to have been met by wheelsets having unworn S1002 or GV 1/40 profiles, as defined in the specification referenced in Appendix J-1, index 86 with spacing of active faces between 1653 mm and 1659 mm.

6.2.3.7 Mechanical and geometric characteristics of wheelsets (clause 4.2.3.5.2.1)

Wheelset:

- (1) The demonstration of compliance for the assembly shall be based on the specification referenced in Appendix J-1, index 87, which defines limit values for the axial force, and the associated verification tests.

Axles:

- (2) The demonstration of compliance for mechanical resistance and fatigue characteristics of the axle shall be in accordance with the specification referenced in Appendix J-1, index 88, clauses 4, 5 and 6 for non-powered axles, or the specification referenced in Appendix J-1, index 89, clauses 4, 5 and 6 for powered axles.

 OTIF	Uniform Technical Prescription (UTP)		UTP LOC&PAS	
	LOCOMOTIVES AND PASSENGER ROLLING STOCK		Page 168 of 272	
Status: DRAFT	Version: 03	TECH-20041 Annex	Original: EN	Date: 20.10.2020

The decision criteria for the permissible stress is specified in the specification referenced in Appendix J-1, index 88, clause 7 for non-powered axles, or the specification referenced in Appendix J-1, index 89, clause 7 for powered axles.

- (3) The assumption of the load conditions for the calculations shall be explicitly stated in the technical documentation as set out in clause 4.2.12 of this

UTP.

~~TSI~~

Verification of the axles:

- (4) A verification procedure shall exist to ensure at the production phase that no defects may detrimentally affect safety due to any change in the mechanical characteristics of the axles.
- (5) The tensile strength of the material in the axle, the resistance to impact, the surface integrity, the material characteristics and the material cleanliness shall be verified.

The verification procedure shall specify the batch sampling used for each characteristic to be verified.

Axle boxes/bearings:

- (6) The demonstration of compliance for mechanical resistance and fatigue characteristics of the rolling bearing shall be in accordance with the specification referenced in Appendix J-1, index 90.
- (7) Other conformity assessment method applicable to wheelsets, axles and wheels where the EN standard do not cover the proposed technical solution:

It is permitted to use other standards where the EN standards do not cover the proposed technical solution; in that case the

assessing entity

~~notified body~~

shall verify that the alternative standards form part of a technically consistent set of standards applicable to the design, construction and testing of the wheelsets, containing specific requirements for wheelset, wheels, axles and axle bearings covering:

- wheelset assembly,
- mechanical resistance,
- fatigue characteristics,
- permissible stress limits,
- thermomechanical characteristics.

Only standards that are publicly available can be referred to in the demonstration required above.

[The verification carried out by the assessing entity shall ensure the consistency between the methodology of the alternative standards, the assumptions taken by the applicant, the intended technical solution and the intended area of use.](#)

- (8) Particular case of wheelsets, axles and axle boxes/bearings manufactured according to an existing design:
In the case of products manufactured according to a design developed and already used to place products on the market before the entry into force of relevant

 OTIF	Uniform Technical Prescription (UTP)		UTP LOC&PAS	
	LOCOMOTIVES AND PASSENGER ROLLING STOCK		Page 169 of 272	
Status: DRAFT	Version: 03	TECH-20041 Annex	Original: EN	Date: 20.10.2020

UTP

~~TSI~~

applicable to those products, the applicant is allowed to deviate from the conformity assessment procedure above, and to demonstrate conformity with the requirements of this

UTP

~~TSI~~

by referring to design review and type examination performed for previous applications under comparable conditions; this demonstration shall be documented, and is considered as providing the same level of proof as module SB or design examination according to module SH1.

6.2.3.7a Automatic variable gauge system

- (1) The safety analysis required in clause 4.2.3.5.3 point (5), and performed at IC level, shall be consolidated at the level of the unit (vehicle); in particular, the assumptions made according to clause 6.1.3.1a point (3) may need to be reviewed to take into account the vehicle and its mission profile.
- (2) The assessment of the integration of the IC within the running gear/unit and the technical compatibility with the track gauge changeover facility shall consist of:
 - The compliance with the area of use defined in clause 5.3.4.a (1) shall be verified Design review.
 - Verification of the correct integration of the IC within the running gear/unit, including the correct performance of its on-board control/monitoring system (when applicable), and
 - On-track tests including tests on the track gauge changeover facility(ies), representative of in-service conditions.

6.2.3.8 Emergency braking (clause 4.2.4.5.2)

- (1) The braking performance which is subject to a test is the stopping distance as defined in the specification referenced in Appendix J-1, index 91. The deceleration is evaluated from the stopping distance.
- (2) Tests shall be carried out on dry rails at the following initial speeds (if lower than the maximum design speed): 30 km/h; 100 km/h; 120 km/h; 140 km/h; 160 km/h; 200 km/h; in steps not greater than 40 km/h from 200 km/h to maximum design speed of the unit.
- (3) Tests shall be carried out for the load conditions of the unit “design mass in working order” “design mass under normal payload” and “maximum braking load” (as defined in clauses 4.2.2.10 and 4.2.4.5.2).
Where 2 of the load conditions above lead to similar brake test conditions according to relevant EN standards or normative documents, it is allowed to reduce the number of tests conditions from 3 to 2.
- (4) Test results shall be evaluated by a methodology that takes into account the following aspects:
 - correction of the raw data.
 - repeatability of the test: in order to validate a test result, the test is repeated several times; the absolute difference between results and the standard deviation are evaluated.

 OTIF	Uniform Technical Prescription (UTP)		UTP LOC&PAS	
	LOCOMOTIVES AND PASSENGER ROLLING STOCK		Page 170 of 272	
Status: DRAFT	Version: 03	TECH-20041 Annex	Original: EN	Date: 20.10.2020

6.2.3.9 Service braking (clause 4.2.4.5.3)

- (1) The maximum service braking performance which is subject to a test is the stopping distance as defined in the specification referenced in Appendix J-1, index 92. The deceleration is evaluated from the stopping distance.
- (2) Tests shall be carried out on dry rail at the initial speed equal to the maximum design speed of the unit, the load condition of the unit being one of those defined in the clause 4.2.4.5.2.
- (3) Test results shall be evaluated by a methodology that takes into account the following aspects:
 - correction of the raw data.
 - repeatability of the test: in order to validate a test result, the test is repeated several times; the absolute difference between results and the standard deviation are evaluated.

6.2.3.10 Wheel slide protection system (clause 4.2.4.6.2)

- (1) If a unit is equipped with a WSP, a test of the unit in low adhesion conditions shall be carried out according to the specification referenced in Appendix J-1, index 93, in order to validate the performance of the WSP system (maximum extension of the stopping distance compared to stopping distance on dry rail) when integrated in the unit.

6.2.3.11 Sanitary systems (clause 4.2.5.1)

- (1) In case the sanitary system allows the release of fluids to the environment (e.g. on the tracks), the assessment of conformity may be based on previous in-service testing when the following conditions are met:
 - The results of the in service tests were obtained on types of equipment which have an identical treatment method.
 - The conditions of test are similar as the ones that may be assumed for the unit under assessment, with regard to loading volumes, environmental conditions, and all other parameters which will influence the efficiency and effectiveness of the treatment process.

If suitable in-service testing results are lacking, type tests shall be performed.

6.2.3.12 Internal air quality (clause 4.2.5.8 and clause 4.2.9.1.7)

- (1) Conformity assessment of the CO₂-levels is permitted to be established by calculation of fresh air ventilation volumes assuming an outside air quality containing 400 ppm CO₂ and an emission of 32 grams of CO₂ per passenger per hour. The number of passengers to be taken into account shall be derived from the occupation under the load condition ‘design mass under normal payload’, as stipulated in clause 4.2.2.10 of this

UTP.

~~TSI~~

6.2.3.13 Slipstream effects on passengers on platform and on trackside workers ~~trackside~~ (clause 4.2.6.2.1)

- (1) Demonstration of conformity with the limit value of trackside maximum permissible air speed set out in clause 4.2.6.2.1 of this UTP shall be demonstrated on the basis of full-scale tests on straight track performed in accordance with clause 6.2.2.1 of specification referenced in Appendix J-1, index 94.

 OTIF	Uniform Technical Prescription (UTP)		UTP LOC&PAS	
	LOCOMOTIVES AND PASSENGER ROLLING STOCK		Page 171 of 272	
Status: DRAFT	Version: 03	TECH-20041 Annex	Original: EN	Date: 20.10.2020

(2) Instead of the full assessment described above, it is permitted to carry out a simplified assessment for rolling stock of a similar design to rolling stock for which the full assessment defined in this UTP has been carried out. In such cases, the simplified conformity assessment defined in clause 4.2.4 of the specification referenced in Appendix J-1, index 94, can be applied as long as the differences in the design remain within the limits of table 7 of the specification referenced in Appendix J-1, index 94.

~~(1) — Conformity shall be assessed on the basis of full scale tests on straight track. The vertical distance between the top of the rail and the surrounding ground level up to 3 m from the track centre shall be within the range of 0,50 m and 1,50 m below the top of the rail. The values of $u_{2\sigma}$ are the upper bound of the 2σ confidence interval of the maximum resultant induced air speeds in the horizontal plane at the above measurements positions. These shall be obtained from at least 20 independent and comparable test samples with ambient wind speeds less than or equal to 2 m/s.~~

~~$U_{2\sigma}$ is given by:~~

~~$$U_{2\sigma} = \bar{U} + 2\sigma$$~~

~~with~~

~~\bar{U} mean value of all air speed measurements $U_{i,j}$, for i train passages, where $i \geq 20$~~

~~σ standard deviation of all air speed measurements $U_{i,j}$, for i train passages, where $i \geq 20$~~

~~(2) — The measurements shall consist of the time period starting 4 s second before the passing of the first axle and continue until 10 s after the last axle has passed.~~

~~The tested train speed $v_{tr,test}$:~~

~~$$v_{tr,test} = v_{tr,ref}, \text{ or}$$~~

~~$$v_{tr,test} = 250 \text{ km/h or } v_{tr,max} \text{ whichever is lower.}$$~~

~~At least 50 % of the train passages shall be within $\pm 5 \%$ of the $v_{tr,test}$ and all train passages shall be within $\pm 10 \%$ of the $v_{tr,test}$~~

~~(3) — All valid measurements shall be used in the post processing of the data. Each measurement $U_{m,i}$ shall be corrected:~~

~~$$U_i = U_{m,i} * v_{tr,ref} / v_{tr,i}$$~~

~~where $v_{tr,i}$ is the train speed for test run i and $v_{tr,ref}$ is the reference train speed.~~

~~(4) — The test site shall be free from any objects providing from sheltering against the train-induced air flow.~~

~~(5) — Meteorological conditions during tests shall be observed as per the specification referenced in Appendix J-1, index 94.~~

~~(6) — Sensors, accuracy, selection of valid data and processing of the data shall be in accordance with the specification referenced in Appendix J-1, index 94.~~

6.2.3.14 Head pressure pulse (clause 4.2.6.2.2)

(1) Conformity shall be assessed on the basis of full-scale tests under conditions specified in the specification referenced in Appendix J-1, index 95, clause [6.1.2.15.5.2](#). Alternatively conformity may be assessed by means of either validated Computational Fluid Dynamics (CFD) simulations as described in the specification referenced in Appendix J-1, index 95, clause [5.36.1.2.4](#) or as an additional alternative

 OTIF	Uniform Technical Prescription (UTP)		UTP LOC&PAS	
	LOCOMOTIVES AND PASSENGER ROLLING STOCK		Page 172 of 272	
Status: DRAFT	Version: 03	TECH-20041 Annex	Original: EN	Date: 20.10.2020

conformity is permitted to be assessed by moving model tests as specified in the specification referenced in Appendix J-1, index 95, clause ~~5.4.3~~[6.1.2.2](#).

- (2) [Instead of the full assessment described above, it is permitted to carry out a simplified assessment for rolling stock of a similar design to rolling stock for which the full assessment defined in this UTP has been carried out. In such cases, the simplified conformity assessment defined in clause 4.1.4 of the specification referenced in Appendix J-1, index 95, can be applied as long as the differences in the design remain within the limits of table 4 of the specification referenced in Appendix J-1, index 95.](#)

6.2.3.15 Maximum pressure variations in tunnels (clause 4.2.6.2.3)

- (1) Conformity shall be proven on the basis of full-scale tests, carried out at reference speed or at a higher speed in a tunnel with a cross-sectional area as close to the reference case as possible. Transfer to the reference condition shall be done with validated simulation software.
- (2) When assessing conformity of whole trains or trainsets, assessment shall be made with the maximum length of the train or coupled trainsets up to 400 m.
- (3) When assessing conformity of locomotives or driving coaches, assessment shall be done on a basis of two arbitrary train compositions of minimum length 150 m, one with a leading locomotive or driving coach (to check the Δp_N) and one with a locomotive or a driving coach at the end (to check Δp_T). Δp_F is set to 1250 Pa (for trains with $v_{tr,max} < 250$ km/h) or to 1400 Pa (for trains with $v_{tr,max} \geq 250$ km/h).
- (4) When assessing conformity of coaches only, assessment shall be done on the basis of one 400 m long train.
 Δp_N is set to 1750 Pa and Δp_T to 700 Pa (for trains with $v_{tr,max} < 250$ km/h) or to 1600 Pa and 1100 Pa (for trains with $v_{tr,max} \geq 250$ km/h).
- (5) For the distance x_p between the entrance portal and the measuring position, the definitions of Δp_{F_r} , Δp_N , Δp_T , the minimum tunnel length and further information about the derivation of the characteristic pressure variation, see the specification referenced in Appendix J-1, index 96.
- (6) The pressure change due to altitude changes between the entry and the exit point in the tunnel shall not be taken into account in the assessment.

6.2.3.16 Cross wind (clause 4.2.6.2.4)

- (1) Conformity assessment is fully specified in clause 4.2.6.2.4

6.2.3.17 Warning Horn sound pressure levels (clause 4.2.7.2.2)

- (1) Sound pressure levels of the warning horn shall be measured and verified in accordance with the specification referenced in Appendix J-1, index 97.

6.2.3.18 Maximum power and current from the overhead contact line (clause 4.2.8.2.4)

- (1) Conformity assessment shall be carried out in accordance with the specification referenced in Appendix J-1, index 98.

 OTIF	Uniform Technical Prescription (UTP)		UTP LOC&PAS	
	LOCOMOTIVES AND PASSENGER ROLLING STOCK		Page 173 of 272	
Status: DRAFT	Version: 03	TECH-20041 Annex	Original: EN	Date: 20.10.2020

6.2.3.19 Power factor (clause 4.2.8.2.6)

- (1) Conformity assessment shall be carried out according to the specification referenced in Appendix J-1, index 99.

6.2.3.19a On-board energy measurement system (clause 4.2.8.2.8)

(1) Energy measurement function (EMF)

The accuracy of each device containing one or more functions of EMF shall be assessed by testing each function, under reference conditions, using the relevant method as described in clauses 5.4.3.4.1, 5.4.3.4.2 and 5.4.4.3.1 of the specification referenced in Appendix J-1, index 117. The input quantity and power factor range when testing shall correspond to the values set out in Table 3 of the specification referenced in Appendix J-1, index 117.

The effects of temperature on accuracy of each device containing one or more functions of EMF shall be assessed by testing each function, under reference conditions (except for temperature), using the relevant method as described in clauses 5.4.3.4.3.1, and 5.4.4.3.2.1 of the specification referenced in Appendix J-1, index 117.

The mean temperature coefficient of each device containing one or more functions of EMF shall be assessed by testing each function, under reference conditions (except for temperature), using the relevant method as described in clauses 5.4.3.4.3.2 and 5.4.4.3.2.2 of the specification referenced in Appendix J-1, index 120.

(2) Data handling system (DHS)

The compiling and handling of data within the DHS shall be assessed by testing using the method as described in the specification referenced in Appendix J-1, index 121.

(3) On-board energy measurement system (EMS)

The EMS shall be assessed by testing as described in the specification referenced in the specification referenced in Appendix J-1, index 122.

6.2.3.20 Current collection dynamic behaviour (clause 4.2.8.2.9.6)

- (1) When a pantograph,
 already assessed separately | holding an EC declaration of conformity or suitability for use as IC,
 is integrated in a rolling stock unit which is assessed according to the
 UTP LOC&PAS, | ~~LOC&PAS TSI~~
 dynamic tests shall be carried out in order to measure the mean contact force and standard deviation or the percentage of arcing, in accordance with the specification referenced in Appendix J-1, index 100 up to the design speed for the unit.
- (2) For a unit designed to be operated on the 1435 mm and 1668 mm track gauge systems, the tests, for each installed pantograph, shall be conducted in both directions of travel and shall include track sections with low contact wire height (defined as between 5.0 to 5.3 m) and track sections with high contact wire height (defined as between 5.5 to 5.75 m).

 OTIF	Uniform Technical Prescription (UTP)		UTP LOC&PAS	
	LOCOMOTIVES AND PASSENGER ROLLING STOCK		Page 174 of 272	
Status: DRAFT	Version: 03	TECH-20041 Annex	Original: EN	Date: 20.10.2020

For units designed to be operated on the 1520 mm and 1524 mm track gauge systems, the tests shall include track sections with contact wire height between 6.0 to 6.3 m.

- (3) The tests shall be performed for a minimum of 3 speed increments up to and including the design speed of the unit. The interval between successive tests shall be no greater than 50 km/h.
- (4) During the test, the static contact force shall be adjusted for each particular power supply system within the range, as specified in clause 4.2.8.2.9.5).
- (5) The measured results shall be in accordance with the clause 4.2.8.2.9.6 for either mean contact force and standard deviation or percentage of arcing.

6.2.3.21 Arrangement of pantographs (clause 4.2.8.2.9.7)

- (1) The characteristics related to the dynamic behaviour of the current collection shall be verified as specified in clause 6.2.3.20 above.

6.2.3.22 Windscreen (clause 4.2.9.2)

- (1) The characteristics of the windscreen shall be verified as specified in the specification referenced in Appendix J-1, index 101.

6.2.3.23 Fire detection systems (clause 4.2.10.3.2)

- (1) The requirement 4.2.10.3.2 (1) shall be deemed to be satisfied by the verification that the rolling stock is equipped with a fire detection system in the following areas:
 - technical compartment or cabinet, sealed or not sealed, containing electrical supply line and/or traction circuit equipment,
 - technical area with a combustion engine,
 - in sleeping cars and sleeping compartments, including their staff compartments and their adjacent gangways and their adjacent combustion heating equipment.

6.2.4 Project phases where assessment is required

- (1) It is detailed in Appendix H of this

UTP

TSI

in which phase of the project an assessment shall be done:

- Design and development phase:
 - Design review and/or design examination
 - Type test: test to verify the design, if and as defined in the section 4.2.
- Production phase: routine test to verify the conformity of production.

The entity in charge of the assessment of the routine tests is determined according to the assessment module chosen.

 OTIF	Uniform Technical Prescription (UTP)		UTP LOC&PAS	
	LOCOMOTIVES AND PASSENGER ROLLING STOCK		Page 175 of 272	
Status: DRAFT	Version: 03	TECH-20041 Annex	Original: EN	Date: 20.10.2020

- (2) The Appendix H is structured according to the section 4.2, which defines the requirements and their assessment applicable to the rolling stock sub-system; where relevant, a reference to a sub-clause of the clause 6.2.2.2 above is also given.

In particular, where a type test is identified in the Appendix H, the section 4.2 shall be considered for the conditions and requirements related to this test.

- (3) Where several

verifications

EC verifications

(e.g. against several

UTPs

~~TSIs~~

addressing the same sub-system) require verification based on the same production assessment (module SD or SF), it is allowed to combine several SB module assessments with one production module assessment (SD or SF). In this case, ISVs shall be issued for the design and development phases according to module SB.

- (4) If module SB is used, the validity of the declaration of intermediate subsystem conformity shall be indicated in accordance with the provisions for phase B of clause 7.1.3

of this UTP.

‘Rules related to the EC verification’, of this TSI.

6.2.5 Innovative solutions

- (1) If an innovative solution

(as defined in Article 3a of ATMF),

(as defined in Article 10),

is proposed for the rolling stock subsystem, the applicant shall apply the procedure described

below:

in article 10.

In order to keep pace with technological progress, innovative solutions may be required, which do not comply with the specifications set out in this UTP and/or to which the assessment methods set out in this UTP cannot be applied. In that case, new specifications and/or new assessment methods associated with those innovative solutions shall be developed.

Innovative solutions may be related to the rolling stock subsystem, its parts and its ICs.

If an innovative solution is proposed, the manufacturer or his authorised representative shall declare how it intends to deviate from or complements the relevant provisions of this UTP. On the basis of this declaration, one of the entities listed in Article 6 § 2 of APTU, or the Secretary General may and submit the new specifications

 OTIF	Uniform Technical Prescription (UTP)		UTP LOC&PAS
	LOCOMOTIVES AND PASSENGER ROLLING STOCK		Page 176 of 272
Status: DRAFT	Version: 03	TECH-20041 Annex	Original: EN Date: 20.10.2020

~~and/or new assessment methods to the deviations to the Secretary General Committee of Technical Experts (CTE) for analysis and approval. The Secretary General will coordinate its opinion with the EU and the European Railway Agency (the Agency) on the proposed innovative solution and submit its opinion to the CTE.~~

If the CTE supports the new specifications and/or new assessment methods ~~opinion~~, the appropriate functional and interface specifications ~~and the assessment method~~, which ~~need~~ must to be included in the UTP in order to allow the use of this innovative solution, shall be developed ~~in coordination with the EU~~ and subsequently integrated in the UTP during ~~their respective~~ its revision processes.

Pending the revision of the UTP, ~~the positive Committee of Technical Experts CTE may already opinion shall be~~ consider ~~ed~~ the new specifications and/or new assessment methods as an acceptable means of compliance with the essential requirements of UTP GEN-A, ~~and may therefore be used for the assessment of the subsystem~~ In such case the Committee of Technical Experts CTE should instruct the Secretary General as to how the new specifications and/or new assessment methods are to be communicated to the Contracting States and made public.

6.2.6 Assessment of documentation requested for operation and maintenance

- | | | |
|-----|--|--|
| (1) | The assessing entity | According to Article 185 (34) of Directive <u>(EU)2016/797</u> 2008/57/EC , a Notified Body |
| | shall be responsible for compiling the technical file, containing the documentation requested for operation and maintenance. | |
| (2) | The assessing entity | The notified body |
| | shall verify only that the documentation requested for operation and maintenance, as defined in clause 4.2.12 of this | |
| | UTP, | TSI , |
| | is provided. | |
| | The assessing entity | The notified body |
| | is not required to verify the information contained in the documentation provided. | |

 OTIF	Uniform Technical Prescription (UTP)		UTP LOC&PAS	
	LOCOMOTIVES AND PASSENGER ROLLING STOCK		Page 177 of 272	
Status: DRAFT	Version: 03	TECH-20041 Annex	Original: EN	Date: 20.10.2020

6.2.7 Assessment of units intended to be used in general operation

- (1) Where a new, upgraded or renewed unit to be used in general operation is subject to assessment against this

UTP	TSI
-----	----------------

(in accordance with clause 4.1.2), some of the

UTP	TSI
-----	----------------

requirements require a reference train for their assessment. This is mentioned in the relevant provisions of section 4.2. Similarly, some of the

UTP	TSI
-----	----------------

requirements at train level cannot be assessed at unit level; such cases are described for the relevant requirements in section 4.2 of this

UTP.	TSI
------	----------------

- (2) The area of use in terms of type of RST which, coupled with the unit to be assessed, ensures that the train is compliant with the

UTP	TSI
-----	----------------

is not verified by the

assessing entity.	notified body.
-------------------	---------------------------

- (3) After such a unit has received the authorisation to be placed in service, its use in a train formation (whether

UTP	TSI
-----	----------------

compliant or not) shall be dealt with under the responsibility of the railway undertaking, according to the rules defined in

Appendix K UTP TCRC	clause 4.2.2.5 of the OPE TSI
--	-------------------------------

(train composition).

6.2.7a Additional optional requirements for units intended to be used in general operation

- (1) The compliance with the following set of conditions (2) to (9) is optional and only aims to facilitate exchange of units intended for general operations. Compliance with these provisions does not assure full interchangeability of units and does not exempt the railway undertaking of its responsibilities regarding the use of these units in a train formation as defined in clause 6.2.7. If the applicant selects this option, a assessing entity has to assess the compliance within the UTP verification procedure. This shall be reported in the certificate and in the technical documentation.

- (2) The unit shall be fitted with a manual coupling system as defined in clauses 4.2.2.2.3 b) and 5.3.2.

 OTIF	Uniform Technical Prescription (UTP)		UTP LOC&PAS	
	LOCOMOTIVES AND PASSENGER ROLLING STOCK		Page 178 of 272	
Status: DRAFT	Version: 03	TECH-20041 Annex	Original: EN	Date: 20.10.2020

- (3) [The unit shall be fitted with an EN-UIC braking system as defined in the specification referenced in Appendix J-1, index 22.](#)
- (4) [The unit shall meet the requirements of this UTP at least within the temperature range T1 \(– 25 °C to + 40 °C; nominal\) as defined in clause 4.2.6.1 of this UTP and in the specification referenced in Appendix J-1, index 34.](#)
- (5) [The tail lights requested in clause 4.2.7.1 shall be provided by fixed tail lamps.](#)
- (6) [If the unit is fitted with a gangway, the gangway shall fulfil the specification referenced in Appendix J-1, index 113.](#)
- (7) [Power supply shall be compliant to point 4 of clause 4.2.11.6.](#)
- (8) [The physical interface between units for the signal transmission shall ensure that the cable and plug of at least one line is compatible with the 18-conductor cable defined in the plate 2 of the specification referenced in Appendix J-1, index 114.](#)
- (9) [The unit shall be marked at least with the following markings in accordance with the specification referenced in Appendix J-1, index 115:](#)
- [Length over buffers.](#)
 - [Electric power supply.](#)

6.2.8 Assessment of units intended to be used in pre-defined formation(s)

- (1) Where a new, upgraded or renewed unit to be included in pre-defined formation(s) is subject to assessment (in accordance with chapter 4.1.2), the

UTP certificate of verification

~~EC certificate of verification~~

shall identify the formation(s) for which the assessment is valid: the type of RST coupled with the unit to be assessed, number of vehicles in the formation(s), arrangement of the vehicles in the formation(s) that will ensure that the train formation will be compliant with this

UTP.

~~TSI.~~

- (2) UTP

~~TSI~~

requirements at train level shall be assessed with use of a reference train formation when and as specified in this

UTP.

~~TSI.~~

- (3) After such a unit has received the authorisation to be placed in service, it may be coupled with other units to constitute the formations mentioned in the

UTP certificate of verification.

~~EC certificate of verification.~~

 OTIF	Uniform Technical Prescription (UTP)		UTP LOC&PAS	
	LOCOMOTIVES AND PASSENGER ROLLING STOCK		Page 179 of 272	
Status: DRAFT	Version: 03	TECH-20041 Annex	Original: EN	Date: 20.10.2020

6.2.9 Particular case: Assessment of units intended to be included in an existing fixed formation

6.2.9.1 Context

- (1) This particular case of assessment applies in case of replacement of a part of a fixed formation, which has already been placed in service.

Two cases are described below, depending on the

UTP

~~TSI~~

status of the fixed formation.

The part of the fixed formation subject to the assessment is called “unit” in the text below.

6.2.9.2 Case of a UTP compliant fixed formation

~~Case of a TSI compliant fixed formation~~

- (1) Where a new, upgraded or renewed unit to be included in an existing fixed formation is subject to assessment against this

UTP

~~TSI~~

and a valid

UTP certificate of verification

~~EC certificate of verification~~

for the existing fixed formation is available, a

UTP

~~TSI~~

assessment only for the new part of the fixed formation is required in order to update the certificate of the existing fixed formation, which is considered as renewed (see also clause 7.1.2.2).

6.2.9.3 Case of a non-UTP compliant fixed formation

Case of a non-TSI compliant fixed formation

- (1) Where a new, upgraded or renewed unit to be included in an existing fixed formation is subject to assessment against this

UTP,

~~TSI,~~

and a valid

UTP certificate of verification

~~EC certificate of verification~~

for the existing fixed formation is not available, the

UTP certificate of verification

~~EC certificate of verification~~

shall state that the assessment does not cover the

 OTIF	Uniform Technical Prescription (UTP)		UTP LOC&PAS
	LOCOMOTIVES AND PASSENGER ROLLING STOCK		Page 180 of 272
Status: DRAFT	Version: 03	TECH-20041 Annex	Original: EN Date: 20.10.2020

UTP

~~TSI~~

requirements applicable to the fixed formation, but only the assessed unit.

6.3 Subsystem containing interoperability constituents

which have not been certified according to the UTP

not holding an EC declaration

This Section is without prejudice to Section 6.1 of this UTP³³.

6.3.1 Conditions

(1) During the transitional period ending on 31 May 2017, a/an

assessing entity

~~notified body~~

is permitted to issue an/a

UTP certificate of verification

~~EC certificate of verification~~

for a subsystem, even if some of the interoperability constituents incorporated within the subsystem are not covered by the relevant

~~UTP certificate~~[declaration](#)

EC declarations

of conformity or suitability for use according to this

UTP

~~TSI~~

(non-certified ICs), if the following criteria are complied with:

(1) The conformity of the subsystem has been checked against the requirements of section 4 and in relation to sections 6.2 to 7 (except ‘Specific cases’) of this

UTP

~~TSI~~

by the

Assessing Entity.

~~Notified Body.~~

Furthermore the conformity of the IC to sections 5 and 6.1 does not apply, and

(2) The interoperability constituents, which are not covered by the relevant

~~UTP certificate~~[declaration](#)

EC declaration

³³ Which means that the separate assessment of ICs is not mandatory by default, and the provisions in this section are only applicable if an IC is assessed separately.

 OTIF	Uniform Technical Prescription (UTP)		UTP LOC&PAS	
	LOCOMOTIVES AND PASSENGER ROLLING STOCK		Page 181 of 272	
Status: DRAFT	Version: 03	TECH-20041 Annex	Original: EN	Date: 20.10.2020

of conformity or suitability for use, have been used in a subsystem already approved and put in service in at least one of the

Contracting States

~~Member States~~

before the date of application of this

UTP.

~~TSI~~

(2) UTP

~~EC~~

declarations of conformity or suitability for use shall not be drawn up for the interoperability constituents assessed in this manner.

6.3.2 Documentation

(1) The UTP certificate of verification

~~The EC certificate of verification~~

of the subsystem shall indicate clearly which interoperability constituents have been assessed by the assessing entity

~~notified body~~

as part of the subsystem verification.

(2) The UTP

~~The EC~~

declaration of verification of the subsystem shall indicate clearly:

- (1) Which interoperability constituents have been assessed as part of the subsystem;
- (2) Confirmation that the subsystem contains the interoperability constituents identical to those verified as part of the subsystem;
- (3) For those interoperability constituents, the reason(s) why the manufacturer did not provide an

UTP

~~EC~~

declaration of conformity or suitability for use before its incorporation into the subsystem, including the application of national rules

notified under Article 12 of APTU.

notified under Article ~~14~~⁷ of Directive [\(EU\) 2016/797](#)~~2008/57/EC~~.

6.3.3 Maintenance of the subsystems certified according to clause 6.3.1

(1) During the transition period as well as after the transition period has ended, until the subsystem is upgraded, renewed (taking into account the

CS

~~MS~~

decision on application of

UTP),

~~TSI~~;

 OTIF	Uniform Technical Prescription (UTP)		UTP LOC&PAS	
	LOCOMOTIVES AND PASSENGER ROLLING STOCK		Page 182 of 272	
Status: DRAFT	Version: 03	TECH-20041 Annex	Original: EN	Date: 20.10.2020

the interoperability constituents which do not hold

a ~~UTP certificate~~ [declaration](#)

an EC declaration

of conformity or suitability for use and of the same type are permitted to be used as maintenance related replacements (spare parts) for the subsystem, under the responsibility of the ECM.

- (2) In any case the ECM must ensure that the components for maintenance related replacements are suitable for their applications, are used within their area of use, and enable interoperability to be achieved within the rail system while at the same time meeting the essential requirements. Such components must be traceable and certified in accordance with any national or international rule, or any code of practice widely acknowledged in the railway domain.

7. IMPLEMENTATION

7.1 General rules for implementation

7.1.1 Application to newly built rolling stock

7.1.1.1 General

- (1) This

UTP

~~TSI~~

is applicable to all units of rolling stock in its scope which

are subject to an admission to operation in international traffic

are placed in service

after ~~the date of~~

~~entry into force of this UTP~~ [1 January 2015](#);

[the date of](#) application set out in Article 12³⁴,

except where clause 7.1.1.2 “Transition phase” or clause 7.1.1.3 “Application to [special vehicles, such as on-track machines](#) ~~OTMs~~” or clause 7.1.1.4 “Application to vehicle designed to be operated solely on 1520 mm system” below apply.

- (2) This

UTP

~~TSI~~

does not apply to units of existing rolling stock which are already

admitted to international operation

placed in service on the network (or part of the network) of one Member State

³⁴ [Article 12 of Commission Regulation \(EU\) No 1302/2014 of 18 November 2014 concerning a technical specification for interoperability relating to the ‘rolling stock — locomotives and passenger rolling stock’ subsystem of the rail system in the European Union as last amended by Commission Implementing Regulation \(EU\) 2020/387 of 9 March 2020.](#)

 OTIF	Uniform Technical Prescription (UTP)		UTP LOC&PAS	
	LOCOMOTIVES AND PASSENGER ROLLING STOCK		Page 183 of 272	
Status: DRAFT	Version: 03	TECH-20041 Annex	Original: EN	Date: 20.10.2020

- ~~at the time when the~~
[by 1 January 2015](#) ~~UTP~~ | at the time when the TSI becomes applicable,
~~becomes applicable,~~ as long as they are not upgraded or renewed (see clause 7.1.2).
- (3) Any rolling stock which is produced according to a design developed after ~~the date of application of this~~
~~UTP~~ [1 January 2015](#) | the date of application of this TSI
shall be compliant with this
- ~~UTP if it is to be admitted to international traffic in~~ TSI.
[accordance with ATMF.](#)
- 7.1.1.2 Transition phase
- 7.1.1.2.1 *Application of the*
UTP | ~~TSI~~
during transition phase
- (1) A significant number of projects or contracts, which started before the date of application of this
UTP, | ~~TSI~~
may lead to the production of rolling stock which does not fully comply with this
UTP. | ~~TSI~~
For rolling stock concerned by those projects or contracts, and in accordance with
point (f) of Article 8§4 of APTU, | point (f) of Article ~~54~~(3) of Directive [\(EU\) 2016/797](#)~~2008/57/EC~~,
a transition phase is defined, ~~during which the application of this~~
[during which this](#) UTP [may be partially applied.](#) | during which the application of this TSI is not
~~is not mandatory.~~ mandatory
- (2) This transition phase applies to:
- Projects at advanced stage of development, as defined in the clause 7.1.1.2.2
 - Contracts in course of performance, as defined in the clause 7.1.1.2.3
 - Rolling stock of an existing design, as defined in clause 7.1.1.2.4.
- (3) For rolling stock which falls under one of the three
cases above, ~~the application of this UTP is not~~ The application of this TSI to rolling stock which
~~mandatory during a transitional period ending on~~ falls under one of the three cases above is not
~~31.12.2020.~~ mandatory if one of the following conditions is
met:

 OTIF	Uniform Technical Prescription (UTP)		UTP LOC&PAS	
	LOCOMOTIVES AND PASSENGER ROLLING STOCK		Page 184 of 272	
Status: DRAFT	Version: 03	TECH-20041 Annex	Original: EN	Date: 20.10.2020

~~During the transitional period~~, the applicant may choose to apply, or partly apply, the UTP on a voluntary basis. ~~In such a case, application of the UTP takes precedence over the application of national technical requirements~~

If this UTP is applied, Contracting States shall mutually recognise UTP compliance or partial UTP compliance when admitting vehicles to international traffic on their territory under the provisions of Article 6 § 4 of ATMF.

- In case the rolling stock is in the scope of the ~~TSI~~-HS RST TSI 2008 or of the ~~TSI~~-CR LOC&PAS TSI 2011, the relevant TSI(s), including implementation rules and period of validity of the “type or design examination certificate” (7 years) are applied. This provision shall not apply to vehicles that are not conform to the HS RST TSI 2008 or to the CR LOC&PAS TSI 2011 and that are placed on the market after 31 May 2017.
- In case the rolling stock is in the scope of neither the HS RST TSI 2008 nor the CR LOC&PAS TSI 2011: the authorisation for placing on the market~~in service~~ is delivered during a transition period ending on 31 December 2020~~6 years after the date of application of this TSI.~~

(4) During the transition phase, if the applicant chooses not to apply this

UTP, the rolling stock shall be subject to requirements applicable in the Contracting States in which the rolling stock is admitted to operation in accordance with Article 6 § 4 of ATMF.

TSI, it is reminded that the other TSIs (see section 2.1) and/or notified national rules apply according to their respective scopes and implementation rules for the authorisation to place on the market in accordance with Article 21 of Directive (EU) 2016/797~~in service in accordance with Articles 22 to 25 of Directive 2008/57/EC.~~

In particular, TSIs to be repealed by this TSI continue to apply, under the conditions stated in Article 11.

7.1.1.2.2 Definition of Projects at advanced stage of development

(1) Rolling stock is developed and produced under a project at an advanced stage of development in accordance with the definition in ~~Article 2 of the~~

Article 2 of the APTU.

point (23) of Article 2 of Directive (EU) 2016/797~~Directive~~

(2) The project shall be at an advanced stage of development ~~at the date of application of this~~

UTP.

at the date of application of this TSI.

7.1.1.2.3 Definition of Contracts in course of performance

(1) Rolling stock is developed and produced under a contract which is signed before the date of application of this

UTP.

~~TSI.~~

 OTIF	Uniform Technical Prescription (UTP)		UTP LOC&PAS	
	LOCOMOTIVES AND PASSENGER ROLLING STOCK		Page 185 of 272	
Status: DRAFT	Version: 03	TECH-20041 Annex	Original: EN	Date: 20.10.2020

- (2) The applicant has to bring evidence of the date of signature of the original contract applicable. The date of any addenda in the form of changes to an original contract shall not be taken into account when defining the date of signature of the contract in question.

7.1.1.2.4 Definition of Rolling Stock of an existing design

- (1) (reserved) | Rolling stock is produced according to a design developed before the date of application of this TSI, and which therefore has not been assessed according to this TSI.

- (2) For the purpose of this

UTP,

~~TSI~~

a rolling stock can be qualified as “built according to existing design” when

the following condition is met:

one of the two following conditions is met:

- The applicant can prove that the newly built rolling stock will be produced according to a documented design that has already been used to produce a rolling stock which has been

admitted to operation in more than one Contracting State before the entry into force of this UTP.

authorised to be placed into service in a Member State before the date of application of this TSI.

- The manufacturer or the applicant can prove that the project was in pre-production phase, or in series production at the date of application of this TSI. In order to prove this, at least one prototype shall be in assembly phase with an existing identifiable body shell, and components already ordered from sub-suppliers shall represent 90% of the total value of components.

The Applicant shall demonstrate to the National Safety Authority that the conditions spelled out under the respective bullet point in this clause (depending on the situation at hand) are met.

- (3) For modifications to an existing design, the following rules apply until 31 May 2017:

- In case of design modifications strictly limited to those necessary to ensure the technical compatibility of the rolling stock with fixed installations (corresponding to interfaces with infrastructure, energy, or control-command and signalling subsystems), the application of this

UTP

~~TSI~~

is not mandatory.

- In case of other design modifications, the present clause related to “existing design” does not apply.

 OTIF	Uniform Technical Prescription (UTP)		UTP LOC&PAS	
	LOCOMOTIVES AND PASSENGER ROLLING STOCK		Page 186 of 272	
Status: DRAFT	Version: 03	TECH-20041 Annex	Original: EN	Date: 20.10.2020

7.1.1.3 Application to special vehicles, such as on-track machines ~~mobile equipment for railway infrastructure construction and maintenance~~

(1) The application of this

UTP

~~TSI~~

to mobile railway infrastructure construction and maintenance equipment (as defined in Sections 2.2 and 2.3) is not mandatory.

(2) The conformity assessment process as described in the clause 6.2.1 may be used by applicants on a voluntary basis in order to establish an

UTP

~~TSI~~

declaration of verification against this

UTP;

~~TSI;~~

This

UTP

~~TSI~~

declaration of verification shall be recognised as such by

Contracting States.

~~Member States.~~

(3) In case the applicant chooses not to apply this

UTP,

~~TSI,~~

the mobile railway infrastructure construction and maintenance equipment may be authorised in accordance with

ATMF Article 6 § 4-

Article 21 of Directive (EU) 2016/797 ~~24 or 25 of Directive 2008/57/EC.~~

against national rules as regards the basic parameters of this UTP.

7.1.1.4 Application to vehicles designed to be operated solely on the 1520 mm system

(1)

The application of this TSI to vehicles designed to be operated solely on the 1520 mm system is not mandatory during a transition period ending six years after the date of application of this TSI.

(2)

The conformity assessment process as described in the clause 6.2.1 may be used by applicants on a voluntary basis in order to establish an EC declaration of verification against this TSI; this EC declaration of verification shall be recognised as such by Member States.

 OTIF	Uniform Technical Prescription (UTP)		UTP LOC&PAS	
	LOCOMOTIVES AND PASSENGER ROLLING STOCK		Page 187 of 272	
Status: DRAFT	Version: 03	TECH-20041 Annex	Original: EN	Date: 20.10.2020

(3)

In case the applicant chooses not to apply this TSI, the vehicle may be authorised in accordance with [Article 21 of Directive \(EU\) 2016/797 against national rules as regards the basic parameters of this TSI](#) ~~Article 24 or 25 of Directive 2008/57/EC.~~

7.1.1.4a Transitional measure for on – board energy measurement system requirement

(reserved)

Requirements set out in 4.2.8.2.8.4 are not mandatory during a transition period ending on 1 January 2022 for projects which, on 14 June 2018, are projects at an advanced stage of development, contracts in course of performance and rolling stock of an existing design as set out in point 7.1.1.2 of this TSI.

When the requirements set out in 4.2.8.2.8.4 are not applied, national rules as regards specification related to interface protocols and transferred data format shall apply and the description of on-board to ground communication shall be provided in the technical documentation.

7.1.1.5 Transitional measure for fire safety requirement

(1) During a transitional period ending

on 31.12.2020,

on 1 January 2018 ~~three years after the date of application of this TSI,~~

it is permitted, as an alternative to material requirements specified in clause 4.2.10.2.1 of the present

UTP,

~~TSI,~~

to apply the verification of conformity to the material fire safety requirements of the notified national rules (using the appropriate operation category) from one of the following sets of standards:

(2) The British standards BS6853, GM/RT2130 issue 3.

(3) The French standards NF F 16-101:1988 and NF F 16-102/1992.

(4) The German standard DIN 5510-2:2009 including toxicity measurements.

(5) The Italian standards UNI CEI 11170-1:2005 and UNI CEI 11170-3:2005.

(6) The Polish standards PN-K-02511:2000 and PN-K-02502:1992.

(7) The Spanish standard DT-PCI/5A.

(8) During this period, it is permitted to substitute individual materials by materials which are compliant with EN 45545-2:2013 (as specified in clause 4.2.10.2.1 of the present **TSI** **UTP**).

 OTIF	Uniform Technical Prescription (UTP)		UTP LOC&PAS	
	LOCOMOTIVES AND PASSENGER ROLLING STOCK		Page 188 of 272	
Status: DRAFT	Version: 03	TECH-20041 Annex	Original: EN	Date: 20.10.2020

7.1.1.6 Transitional measure for noise requirements specified in the TSI HS RST 2008

- (1) For units of maximum design speed higher than or equal to 190 km/h
intended to be operated on the on the High Speed TEN network,
requirements defined in clause 4.2.6.5 “Exterior noise” and in clause 4.2.7.6 “Interior noise” of the TSI HS RST 2008³⁵ shall apply.
- (2) This transitional measure is applicable until a revised
UTP ~~TSI~~
Noise covering all types of rolling stock is applicable.

7.1.1.7 Transitional measure for crosswind requirements specified in the TSI HS RST 2008

- (1) (reserved) For units of maximum design speed higher than or equal to 250 km/h intended to be operated on the High Speed TEN network, it is permitted to apply requirements defined in clause 4.2.6.3 “Crosswind” of the TSI HS RST 2008, as specified in clause 4.2.6.2.4 of the present TSI.
- (2) (reserved) This transitional measure is applicable until revision of the clause 4.2.6.2.4 of the present TSI.

7.1.1.8 Transitional measure for passive safety requirement

(reserved)

Requirements set out in 4.2.2.5(6) shall not be mandatory during a transition period ending on 1 January 2022 for locomotives with a single “central cab” which, on 27 May 2019, are projects at an advanced stage of development, contracts in course of performance and rolling stock of an existing design as set out in point 7.1.1.2 of this TSI. When the requirements set out in 4.2.2.5(6) are not applied, it is permitted as an alternative method, to demonstrate compliance against the requirement of scenario 3 of 4.2.2.5(5) by demonstrating compliance with following criteria:

- the frame of the locomotive is designed according to the specification referenced in Appendix J-1, index 7 cat L (as already specified in clause 4.2.2.4 of this TSI).

³⁵ COMMISSION DECISION of 21 February 2008 concerning a technical specification for interoperability relating to the ‘rolling stock’ sub-system of the trans-European high-speed rail system (2008/232/CE)

 OTIF	Uniform Technical Prescription (UTP)		UTP LOC&PAS	
	LOCOMOTIVES AND PASSENGER ROLLING STOCK		Page 189 of 272	
Status: DRAFT	Version: 03	TECH-20041 Annex	Original: EN	Date: 20.10.2020

- the distance between the buffers and the cab windscreen is at least 2,5 m.

7.1.2 ~~Changes to an~~ **Renewal and upgrade of** existing rolling stock or rolling stock type

7.1.2.1 Introduction

(1) This clause 7.1.2 ~~provides~~ defines ~~information which relates to~~ the principles to be applied by

the entities managing the change.

The entity managing the change is either the holder of the Certificate of Operation of a vehicle, which, in accordance with Article 11§8 of ATMF, is the keeper, or, if the change concerns a type, the holder of the Design Type Certificate.

~~Article 10§11 of ATMF.~~

the entities managing the change and authorising entities in line with the EC verification procedure described in Article 15(9), Article 21(12) and Annex IV of Directive (EU) 2016/797. This procedure is further developed in Article 13, 15 and 16 of Commission Implementing Regulation (EU) 2018/545³⁶ and in Decision 2010/713/EU³⁷.

~~Article 20 of Directive 2008/57/EC.~~

(2) This clause 7.1.2 applies in case of any change(s) to an existing rolling stock or rolling stock type, including renewal or upgrade. It does not apply in case of changes:

- that do not introduce a deviation from the technical files accompanying the UTP declaration for verification for the subsystems, if any, and
- that do not have an impact on basic parameters not covered by the UTP declaration, if any.

The holder of the

Design Type Certificate, if this is not itself the entity managing the change,

vehicle type authorisation

shall provide, under reasonable conditions, the information necessary for assessing the changes to the entity managing the change.

7.1.2.2 Rules to manage changes in both rolling stock and rolling stock type **Renewal**

~~The Member State shall use the following principles as a basis for determining the application of this~~

~~UTP~~

~~TSI~~

~~-in case of renewal:~~

(1) ~~— A new assessment against the requirements of this~~

~~UTP~~

~~TSI~~

³⁶- [Commission Implementing Regulation \(EU\) 2018/545 of 4 April 2018 establishing practical arrangements for the railway vehicle authorisation and railway vehicle type authorisation process pursuant to Directive \(EU\) 2016/797 of the European Parliament and of the Council \(OJ L 90, 6.4.2018, p. 66\)](#)

³⁷- [Commission Decision 2010/713/EU of 9 November 2010 on modules for the procedures for assessment of conformity, suitability for use and EC verification to be used in the technical specifications for interoperability adopted under Directive 2008/57/EC of the European Parliament and of the Council \(OJ L 319, 4.12.2010, p. 1\)](#)



~~is only needed for the basic parameters in this~~

~~UTP~~

~~TSI~~

~~which may have their performance influenced by the modification(s).~~

~~(2) For existing non-~~

~~UTP~~

~~TSI~~

~~compliant rolling stock, when during the renewal it is not economically feasible to fulfil the~~

~~UTP~~

~~TSI~~

~~requirement, the renewal could be accepted if it is evident that a basic parameter is improved in the direction of the~~

~~UTP~~

~~TSI~~

~~defined performance.~~

~~In such a case, the admission to international traffic of the unit shall be reconsidered by the application of ATMF Article 6 §4.~~

~~(3) National migration strategies related to the implementation of other~~

~~UTP (e.g. UTP covering fixed installations)~~

~~TSI (e.g. TSI covering fixed installations)~~

~~may have an impact to what extent this~~

~~UTP~~

~~TSI~~

~~needs to be applied.~~

~~In such a case the admission to international traffic of the unit shall be reconsidered by the application of ATMF Article 6 §4.~~

~~(4) For a project including elements not being~~

~~UTP~~

~~TSI~~

~~conform, the procedures for the assessment of conformity and~~

~~UTP~~

~~EC~~

~~verification to be applied should be agreed with the~~

~~Contracting States concerned.~~

~~Member State.~~



~~In such a case the admission to international traffic of the unit shall be reconsidered by the application of ATMF Article 6 § 4.~~

~~(5) For existing non-~~

~~UTP~~

~~TSI~~

~~compliant design of rolling stock, the replacement of a whole unit or (a) vehicle(s) within a unit (e.g. a replacement after a severe damage; see also clause 6.2.9) does not require a conformity assessment against this~~

~~UTP,~~

~~TSI,~~

~~as long as the unit or the vehicle(s) are identical to the ones they replace. Such units must be traceable and certified in accordance with any national or international rule, or any code of practice widely acknowledged in the railway domain.~~

~~(6) For the replacement of~~

~~UTP~~

~~TSI~~

~~conform units or vehicles, a conformity assessment against this~~

~~UTP~~

~~TSI~~

~~is required.~~

(1) Parts and basic parameters of the rolling stock that are not affected by the change(s) are exempt from conformity assessment against the provisions in this UTP.

(2) Without prejudice to clause 7.1.2.2a, compliance with the requirements of this UTP, the UTP Noise (see clause 7.2 of that UTP) and the UTP PRM (see clause 7.2.3 of that UTP) shall only be needed for the basic parameters in this UTP which may be affected by the change(s).

(3) Any basic parameter of a vehicle or a vehicle type affected by the changes shall be analysed and categorised in one of the following categories:

(1) Changes that do not introduce a deviation from the technical file.

(2) Changes that do not fall into category 1 and which do not change the basic design characteristics as per table 17a.

(3) Changes that do not fall into category 2 and which do not require a new admission in accordance with the criteria in this section.

In accordance with Articles 15 and 16 of Commission Implementing Regulation (EU) 2018/545 and Decision 2010/713/EU and by application of modules SB, SD/SF or SH1 for the EC verification, and if relevant in accordance with Article 15(5) of Directive (EU) 2016/797, the entity managing the change shall inform a notified body of all changes affecting the conformity of the subsystem with requirements of the relevant TSI(s) requiring new checks by a notified body. This information shall be provided by the entity managing the change with corresponding references to the technical documentation relating to the existing EC type or design examination certificate.



(4) Changes that do not fall into categories 1-3 and specific changes described in this section.

For category 1 no further action is required.

For categories 2 and 3 the technical file shall be updated and the holder of the Design Type Certificate or, if there is no Design Type Certificate, the holder of the Certificate of Operation shall make the relevant information available to the competent authorities upon request.

For category 4, a new admission in accordance with Article 10 § 11 of ATMF is required. An assessing entity shall be informed by the entity managing the change of all changes to the subsystem that affect the conformity with requirements of the relevant UTPs(s) and which require new checks by the assessing entity.

Modules SB, SD/SF or SH1 as defined in UTP GEN—D shall apply mutatis mutandis to the assessment of changes.

The assessing entity shall be provided with all relevant technical documentation relating to the existing Design Type Certificate and, if available, the Certificate of Operation.

For physical vehicles this information shall be provided by the keeper, as holder of the Certificate of Operation.

If the change is to a type of vehicle, the holder of the Design Type Certificate shall provide this information.

(4) In case of changes requiring reassessment of the safety requirements set out in clauses 4.2.3.4.2, 4.2.3.5.3, 4.2.4.2.2, 4.2.5.3.5, 4.2.5.5.8 and 4.2.5.5.9, the procedure set out in clause 6.2.3.5 shall be applied. Table 17 sets out when a new admission is required.

Without prejudice of the general safety judgement mandated in article 21(12) (b) of Directive (EU) 2016/797, in case of changes requiring reassessment of the safety requirements set out in clauses 4.2.3.4.2, 4.2.3.5.3, 4.2.4.2.2, 4.2.5.3.5, 4.2.5.5.8 and 4.2.5.5.9, the procedure set out in clause 6.2.3.5 shall be applied. Table 17 sets out when a new authorisation is required.

Table 17. The cases when a new admission is required

		Vehicle originally assessed against...		
		First method of clause 6.2.3.5(3)	Second method of clause 6.2.3.5(3)	No UTP GEN-G applied
Change assessed against...	First method of clause 6.2.3.5(3)	No new admission required	Check(*)	No new admission required
	Second method of clause 6.2.3.5(3)	Check(*)	Check(*)	Check(*)
	No UTP GEN-G applied	Not possible	Not possible	Not possible

(*) The word “Check” means that the applicant will apply Annex I of the UTP GEN-G in order to demonstrate that the changed vehicle ensures an equal or higher level of safety. This demonstration shall be independently assessed by an assessing entity as defined in UTP GEN-G. If the body concludes that the new safety assessment demonstrates a lower level of safety or the result is unclear, the applicant shall request a new vehicle admission.

- | | | |
|------|--|---|
| (4a) | <p><u>In case of changes requiring reassessment of the safety requirements set out in clauses 4.2.4.9, 4.2.9.3.1 and 4.2.10.3.4 which require a new reliability study, a new admission shall be required unless the assessing entity concludes that the safety-related requirements covered by the reliability study are improved or maintained. In its assessment the assessing entity will consider the revised maintenance and operation documentation, where required.</u></p> | <p><u>Without prejudice of the general safety judgement mandated in Article 21(12) (b) of Directive (EU) 2016/797, in case of changes impacting requirements set out in 4.2.4.9, 4.2.9.3.1 and 4.2.10.3.4 which require a new reliability study, a new authorisation for placing in the market shall be required unless the assessing entity concludes that the safety-related requirements covered by the reliability study are improved or maintained. The assessing entity will consider in its judgement the revised maintenance and operation documentation, where required.</u></p> |
| (5) | <p><u>(reserved)</u></p> | <p><u>National migration strategies related to the implementation of other TSIs (e.g. TSIs covering fixed installations) shall be taken into account when defining to what extent the TSIs covering rolling stock needs to be applied.</u></p> |
| (6) | <p><u>Changes of category 3 and 4 require assessment as to whether the overall safety level of the vehicle is adversely affected by the changes.</u></p> <p><u>The following changes shall fall into category 3:</u></p> <ul style="list-style-type: none"> <u>– Changes above the thresholds set out in column 3 and below thresholds set out in column 4 of Tables 17a and 17b and</u> | <p><u>The basic design characteristics of the rolling stock are defined in Table 17a and Table 17b. Based on these tables and on the safety judgement mandated in Article 21(12) (b) of Directive (EU) 2016/797, the changes shall be categorised as follows:</u></p> <ul style="list-style-type: none"> <u>a) 15(1)(c) of Commission Implementing Regulation (EU) 2018/545 if they are above the thresholds set out in column 3 and below</u> |



which do not adversely affect the overall safety level of the vehicle.

The following changes shall fall into category 4:

- Changes above the thresholds set out in in column 4 of Tables 17a and 17b and changes which may adversely affect the overall safety level of the vehicle.

thresholds set out in column 4 unless the safety judgement mandated in Article 21(12) (b) of Directive (EU) 2016/797 requires to categorise them as 15(1)(d), or

- b) 15(1)(d) of Commission Implementing Regulation (EU) 2018/545 if they are above the thresholds set out in column 4 or if the safety judgement mandated in Article 21(12) (b) of Directive (EU) 2016/797 requires to categorise them as 15(1)(d).

The determination whether the changes are beyond or above the thresholds mentioned above shall be done in reference to the values of the parameters at the time

of the most recent admission of the rolling stock or rolling stock type.

of the last authorisation of the rolling stock or rolling stock type.

(7) Changes not covered by point 7.1.2.2 (6) above are deemed not to have any impact on the basic design characteristics and may

fall into category 1 or 2, unless the assessment of the overall safety level of the vehicle in accordance with point 8 concludes that safety is adversely affected by the changes. In such case the changes fall into category 4.

be categorised as 15(1)(a) or 15(1)(b) of Commission Implementing Regulation (EU) 2018/545, unless the safety judgement mandated in Article 21(12) (b) of Directive (EU) 2016/797 requires to categorise them as 15(1)(d).

(8) The assessment as to whether the overall safety level of the vehicle is adversely affected shall be carried out in accordance with UTP GEN-G and shall cover all changes concerning basic parameters of table of section 3.1, related to all the essential requirements, in particular the requirements “Safety” and “Technical compatibility”.

The safety judgement mandated in Article 21(12)(b) of Directive (EU) 2016/797 shall cover changes concerning basic parameters of the table of section 3.1, related to all the essential requirements, in particular the requirements “Safety” and “Technical compatibility”.

(9) Without prejudice to clause 7.1.2.2a, all changes shall remain compliant with the applicable UTPs regardless their classification.

(10) The replacement of one or more vehicle(s) within a fixed formation after a severe damage does not require a conformity assessment against this TSI, as long as the unit or the vehicle(s) are unchanged in technical parameters and function to the ones they replace. Such units must be traceable and certified in accordance with any national or international rule, or any code of practice widely acknowledged in the railway domain.

*Table 17a Basic design characteristics related to basic parameters set out in the UTP LOC&PAS*

<u>1. Clause</u>	<u>2. Related basic design characteristic(s)</u>	<u>3. Changes³⁸ impacting the basic design characteristic which remain within the range of acceptable parameters with respect to technical compatibility with the area of use</u>	<u>4. Changes³⁹ impacting the basic design characteristic which go beyond the range of acceptable parameters with respect to technical compatibility with the area of use</u>
<u>4.2.2.2.3 End coupling</u>	<u>Type of end coupling</u>	<u>Change of end coupler type</u>	<u>N/A</u>
<u>4.2.2.10 Load conditions and weighed mass</u> <u>4.2.3.2.1 Axle load parameter</u>	<u>Design mass in working order</u> <u>Design mass under normal payload</u> <u>Design mass under exceptional payload</u> <u>Maximum design speed (km/h)</u> <u>Static axle load in working order</u> <u>Static axle load under exceptional payload</u> <u>Vehicle length</u> <u>Static axle load under normal payload</u> <u>Position of the axles along the unit (axle spacing)</u>	<u>Change in any of the corresponding basic design characteristics resulting in a change of the line category(ies) the vehicle is compatible with</u>	<u>N/A</u>
	<u>Total vehicle mass (for each vehicle of the unit)</u>	<u>Change in any of the corresponding basic design characteristics resulting in a change of the line category(ies) the vehicle is compatible with</u>	<u>Change of more than $\pm 10\%$</u>
	<u>Mass per wheel</u>	<u>Change in any of the corresponding basic design characteristics resulting in a change of the line category(ies) the vehicle is compatible with or</u> <u>Change of more than $\pm 10\%$</u>	<u>N/A</u>
<u>4.2.3.1 Gauging</u>	<u>Reference profile</u>	<u>N/A</u>	<u>Change of reference profile the vehicle is conform to</u>

³⁸- EU title: "Changes impacting the basic design characteristic and not classified as 21(12) (a) of Directive (EU) 2016/797"³⁹- EU title: "Changes impacting the basic design characteristic and classified as 21(12) (a) of Directive (EU) 2016/797"



1. Clause	2. Related basic design characteristic(s)	3. Changes³⁸ impacting the basic design characteristic which remain within the range of acceptable parameters with respect to technical compatibility with the area of use	4. Changes³⁹ impacting the basic design characteristic which go beyond the range of acceptable parameters with respect to technical compatibility with the area of use
	Minimum vertical convex curve radius capability	Change in minimum vertical convex curve radius capability the vehicle is compatible with of more than 10%	N/A
	Minimum vertical concave curve radius capability	Change in minimum vertical concave curve radius capability the unit is compatible with of more than 10%	N/A
4.2.3.3.1 Rolling stock characteristics for the compatibility with train detection systems	Compatibility with train detection systems	N/A	Change of declared compatibility with one or more of the three following train detection systems: <ul style="list-style-type: none"> - Track circuits - Axle counters - Loop equipment
4.2.3.3.2 Axle bearing condition monitoring	On-board detection system	Fitting of on-board detection system	Removal of declared on-board detection system
4.2.3.4 Rolling stock dynamic behaviour	Combination of maximum speed and maximum cant deficiency for which the vehicle was assessed	N/A	Increase in maximum speed of more than 15 km/h or change of more than ± 10 % in maximum admissible cant deficiency
	Rail inclination	N/A	Change of rail inclination(s) the vehicle is conform to(*)
4.2.3.5.2.1 Mechanical and geometric characteristics of wheelsets	Wheelset gauge	N/A	Change of track gauge the wheelset is compatible with
4.2.3.5.2.2 Characteristics of wheels	Minimum required in-service wheel diameter	Change of minimum required in-service diameter of more than ± 10 mm	N/A
4.2.3.5.2.3 Automatic variable gauge systems	Wheelset gauge changeover facility	Change in the unit leading to a change in the changeover facility(ies) the wheelset is compatible with	Change of track gauge(s) the wheelset is compatible with
4.2.3.6 Minimum curve radius	Minimum horizontal curve radius capability	Increase of minimum horizontal curve radius of more than 5 m	N/A



1. Clause	2. Related basic design characteristic(s)	3. Changes ³⁸ impacting the basic design characteristic which remain within the range of acceptable parameters with respect to technical compatibility with the area of use	4. Changes ³⁹ impacting the basic design characteristic which go beyond the range of acceptable parameters with respect to technical compatibility with the area of use
4.2.4.5.1 Braking performance – General requirements	Maximum average deceleration	Change of more than ± 10 % on the maximum average brake deceleration	N/A
4.2.4.5.2 Braking performance – Emergency braking	Stopping distance and deceleration profile for each load condition per design maximum speed	Change of stopping distance of more than ± 10 % Note: Brake weight percentage (also called “lambda” or “braked mass percentage”) or braked mass may also be used, and can be derived (directly or via stopping distance) from deceleration profiles by a calculation. The allowed change is the same (± 10 %)	N/A
4.2.4.5.3 Braking performance – Service braking	Stopping distance and maximum deceleration for the load condition “design mass under normal payload” at the design maximum speed	Change of stopping distance of more than ± 10 %	N/A
4.2.4.5.4 Braking performance – Thermal capacity	Maximum brake thermal energy capacity or Thermal capacity in terms of maximum line gradient, associated length and operating speed	N/A Change of maximum gradient, associated length or operating speed for which the brake system is designed in relation with brake thermal energy capacity	Change of maximum brake thermal energy ≥ 10 %
4.2.4.5.5 Braking performance – Parking brake	Maximum gradient on which the unit is kept immobilized by the parking brake alone (if the vehicle is fitted with it)	Change of declared maximum gradient of more than ± 10 %	N/A
4.2.4.6.2. Wheel slide protection system	Wheel slide protection system	N/A	Fitting/removal of WSP function
	Magnetic track brake	N/A	Fitting/removal of magnetic track brake function



1. Clause	2. Related basic design characteristic(s)	3. Changes³⁸ impacting the basic design characteristic which remain within the range of acceptable parameters with respect to technical compatibility with the area of use	4. Changes³⁹ impacting the basic design characteristic which go beyond the range of acceptable parameters with respect to technical compatibility with the area of use
4.2.4.8.2 Magnetic track brake	Possibility of preventing the use of the magnetic track brake	N/A	Fitting/removal of the brake control allowing the activation/deactivation of magnetic track brake
4.2.4.8.3 Eddy current track brake	Eddy current track brake	N/A	Fitting/removal of the eddy current track brake function
	Possibility of preventing the use of the eddy current track brake	N/A	Fitting/removal of the brake control allowing the activation/deactivation of eddy current track brake
4.2.6.1.1 Temperature	Temperature range	Change of temperature range (T1, T2, T3)	N/A
4.2.6.1.2 Snow, ice and hail	Snow, ice and hail conditions	Change of the selected range "snow, ice and hail" (nominal or severe)	N/A
4.2.8.2.2 Operation within range of voltages and frequencies	Energy supply system (voltage and frequency)	N/A	Change of voltage(s)/frequency (ies) of the energy supply system (AC 25 kV-50 Hz, AC 15 kV-16,7 Hz, DC 3 kV, DC 1,5 kV, DC 750 V, third rail, others)
4.2.8.2.3 Regenerative brake with energy to the overhead contact line	Regenerative brake	N/A	Fitting/removal of regenerative brake function
	Possibility of preventing the use of the regenerative brake when fitted	Fitting/removing the possibility of preventing the use of regenerative brake	N/A
4.2.8.2.4 Maximum power and current from the overhead contact line	Applicable to Electric units with power higher than 2 MW only: Power or current limitation function	Power or current limitation function fitted/removed	N/A
4.2.8.2.5 Maximum current at standstill for DC systems	Maximum current at standstill per pantograph for each DC system the vehicle is equipped for	Change of the maximum current value by 50 A without exceeding the limit set in the TSI	N/A



1. Clause	2. Related basic design characteristic(s)	3. Changes ³⁸ impacting the basic design characteristic which remain within the range of acceptable parameters with respect to technical compatibility with the area of use	4. Changes ³⁹ impacting the basic design characteristic which go beyond the range of acceptable parameters with respect to technical compatibility with the area of use
4.2.8.2.9.1.1 <u>Height of interaction with contact wires (RST level)</u>	<u>Height of interaction of pantograph with contact wires (over top of rail)</u>	<u>Change of height of interaction allowing/no longer allowing mechanical contact with one of the contact wires at heights above rail level between: 4 800 mm and 6 500 mm 4 500 mm and 6 500 mm 5 550 mm and 6 800 mm 5 600 mm and 6 600 mm</u>	N/A
4.2.8.2.9.2 <u>Pantograph head geometry (IC level)</u>	<u>Pantograph head geometry</u>	N/A	<u>Change of pantograph head geometry to or from one of the types defined in clauses 4.2.8.2.9.2.1, 4.2.8.2.9.2.2 or 4.2.8.2.9.2.3</u>
4.2.8.2.9.4.2 <u>Contact strip material</u>	<u>Contact strip material</u>	<u>New contact strip as per 4.2.8.2.9.4.2(3)</u>	N/A
4.2.8.2.9.6 <u>Pantograph contact force and dynamic behaviour</u>	<u>Mean contact force curve</u>	<u>Change requiring a new assessment of pantograph dynamic behaviour.</u>	N/A
4.2.8.2.9.7 <u>Arrangement of pantographs (RST level)</u>	<u>Number of pantograph and shortest distance between two pantographs</u>	N/A	<u>Where the spacing of 2 consecutive pantographs in fixed or predefined formations of the assessed unit is reduced by means of removing a vehicle</u>
4.2.8.2.9.10 <u>Pantograph lowering (RST level)</u>	<u>Automatic dropping device (ADD)</u>	<u>Automatic dropping device (ADD) function fitted/removed</u>	N/A
4.2.10.1. <u>General and categorisation</u>	<u>Fire safety category</u>	N/A	<u>Change of fire safety category</u>
4.2.12.2.General <u>documentation – number of units in multiple operation</u>	<u>Maximum number of trainsets or locomotives coupled together in multiple operation.</u>	N/A	<u>Change of maximum allowed number of trainsets or locomotives coupled together in multiple operation</u>
4.2.12.2.General <u>documentation – number of vehicles in a unit</u>	<u>For fixed formations only: Vehicles composing the fixed formation</u>	N/A	<u>Change in the number of vehicles composing the fixed formation</u>

 OTIF	Uniform Technical Prescription (UTP)		UTP LOC&PAS	
	LOCOMOTIVES AND PASSENGER ROLLING STOCK		Page 200 of 272	
Status: DRAFT	Version: 03	TECH-20041 Annex	Original: EN	Date: 20.10.2020

(*) The rolling stock fulfilling one of the following conditions are deemed to be compatible with all rail inclinations:

- (1) Rolling stock assessed according to EN 14363:2016
- (2) Rolling stock assessed according to EN 14363:2005 (amended or not amended by ERA/TD/2012-17/INT) or UIC 518:2009 with the result, that there is no restriction to one rail inclination
- ~~(1)~~(3) Rolling stock assessed according to EN 14363:2005 (amended or not amended by ERA/TD/2012-17/INT) or UIC 518:2009 with the result, that there is a restriction to one rail inclination and a new assessment of the wheel-rail-contact test conditions based on real wheel- and rail profiles and measured track gauge show compliance with the requirements on wheel-rail-contact conditions of EN 14363:2016.

Table 17b Basic design characteristics related to basic parameters set out in the UTP PRM

<u>1. Clause</u>	<u>2. Related basic design characteristic(s)</u>	<u>3. Changes⁴⁰ impacting the basic design characteristic which remain within the range of acceptable parameters with respect to technical compatibility with the area of use</u>	<u>4. Changes⁴¹ impacting the basic design characteristic which go beyond the range of acceptable parameters with respect to technical compatibility with the area of use</u>
<u>4.2.2.11 Step position for vehicle access and egress</u>	<u>Platform heights for which the vehicle is designed</u>	<u>N/A</u>	<u>Change of platform height the vehicle is compatible with</u>

(11) In order to establish the type or design examination certificate⁴²

in accordance with UTP GEN-D, the assessing entity is permitted to refer to:

, the notified body selected by the entity managing the change may refer to:

- The original type or design examination certificate for parts of the design that are unchanged or those that are changed but do not affect the conformity of the subsystem, as far as it is still valid (during 7 years phase B period);
- Additional type or design examination certificate (amending the original certificate) for modified parts of the design that affect the conformity of the subsystem with the latest revision of this UTP or equivalent TSI in force at that time.

The validity period of the type or design examination certificate for the modified type, type variant or type version shall be limited to 7 years from the date of issuing, without exceeding 14 years after the date of appointment of a assessing entity by the applicant for the initial rolling stock type (beginning of phase A of the original type or design examination certificate).

(12) In any case, the entity managing the change shall ensure that the technical documentation which is relating to the type or design examination certificate is updated accordingly.

⁴⁰- EU title: "Changes impacting the basic design characteristic and not classified as 21(12) (a) of Directive (EU) 2016/797"

⁴¹- EU title: "Changes impacting the basic design characteristic and classified as 21(12) (a) of Directive (EU) 2016/797"

⁴²- In EU law reference is made to the EC type or design examination certificate.

 OTIF	Uniform Technical Prescription (UTP)		UTP LOC&PAS	
	LOCOMOTIVES AND PASSENGER ROLLING STOCK		Page 201 of 272	
Status: DRAFT	Version: 03	TECH-20041 Annex	Original: EN	Date: 20.10.2020

(13) The updated technical documentation, related to the type or design examination certificate is referred to in the technical file accompanying the declaration of verification issued by the entity managing the change for rolling stock declared as conformant to the modified type.

7.1.2.2a Particular rules for existing rolling stock

of which the admission to international traffic was prior to 1 January 2015 and was not based on UTPs or equivalent EU provisions.

not covered by an EC declaration of verification with a first authorisation for placing in service before 1 January 2015

(1) The following rules apply, in addition to clause 7.1.2.2, to existing rolling stock with a first admission to international traffic before 1 January 2015, which were not assessed for compliance with the UTPs before their admission (if any).

The following rules apply, in addition to clause 7.1.2.2, to existing rolling stock with a first authorisation for placing in service before 1 January 2015, where the scope of the change has an impact on basic parameters not covered by the EC declaration (if any).

(2) Changes shall be deemed compliant with the technical requirements in this UTP if:

The compliance with technical requirements of this TSI is deemed established when a basic parameter is improved in the direction of the TSI defined performance and the entity managing the change demonstrates that the corresponding essential requirements are met and the safety level is maintained and, where reasonably practicable, improved. The entity managing the change shall in this case justify the reasons for which the TSI defined performance was not met, taking into account paragraph 3 of section 7.1.2.2.

- the values of the parameters set out in the UTP are improved in the direction of the value defined in the UTP and
- the entity managing the change demonstrates that the essential requirements which are concerned by the change are met and
- the safety level is not reduced.

The entity managing the change shall, in cases where the UTP requirement was not met, taking into account paragraph (3) of section 7.1.2.2.

This justification shall be included in the technical file, if any, or in the original technical documentation of the vehicle.

(3) The particular rule set out in paragraph (2) above is not applicable to changes to basic parameters classified in tables 17c and 17d. For those changes, compliance with the UTP requirements is mandatory.



Table 17c Changes to basic parameters of vehicles of which the admission to international traffic was not based on UTPs or equivalent EU provisions⁴³

<u>Clause</u>	<u>Related basic design characteristic(s)</u>	<u>Changes which shall comply with the UTP requirements⁴⁴</u>
4.2.3.1 Gauging	Reference profile	Change of reference profile the vehicle is conform to
4.2.3.3.1 Rolling stock characteristics for the compatibility with train detection systems	Compatibility with train detection systems	Change of declared compatibility with one or more of the three following train detection systems: <ul style="list-style-type: none"> - Track circuits - Axle counters - Loop equipment
4.2.3.3.2 Axle bearing condition monitoring	On-board detection system	Fitting/removal of declared on-board detection system
4.2.3.5.2.1 Mechanical and geometric characteristics of wheelsets	Wheelset gauge	Change of track gauge the wheelset is compatible with
4.2.3.5.2.3 Automatic variable gauge systems	Wheelset gauge changeover facility	Change of track gauge(s) the wheelset is compatible with
4.2.8.2.3 Regenerative brake with energy to the overhead contact line	Regenerative brake	Fitting/removal of regenerative brake function

Table 17d Changes to basic parameters of the UTP PRM of which the admission to international traffic was not based on UTPs or equivalent EU provisions⁴⁵

<u>Clause</u>	<u>Related basic design characteristic(s)</u>	<u>Changes which shall comply with the UTP requirements⁴⁶</u>
4.2.2.11 Step position for vehicle access and egress	Platform heights for which the vehicle is designed	Change of platform height the vehicle is compatible with

⁴³- Title of this table in the TSI: "[Changes to basic parameters for which compliance with TSI requirements is mandatory for rolling stock not holding an EC type or design examination certificate](#)"

⁴⁴- EU title: "[Changes impacting the basic design characteristic and classified as 21\(12\) \(a\) of Directive \(EU\) 2016/797](#)"

⁴⁵- Title of this table in the TSI: "[Changes to basic parameters of the PRM TSI for which compliance with TSI requirements is mandatory for rolling stock not holding an EC type or design examination certificate](#)"

⁴⁶- EU title: "[Changes impacting the basic design characteristic and classified as 21\(12\) \(a\) of Directive \(EU\) 2016/797](#)"

 OTIF	Uniform Technical Prescription (UTP)		UTP LOC&PAS	
	LOCOMOTIVES AND PASSENGER ROLLING STOCK		Page 203 of 272	
Status: DRAFT	Version: 03	TECH-20041 Annex	Original: EN	Date: 20.10.2020

7.1.2.2b Particular rules for vehicles modified to test performance or reliability of technological innovations for a limited period of time

- (1) The following rules apply, in addition to clause 7.1.2.2, in case of modifications to single authorised vehicles for the purpose of testing the performance and reliability of technological innovations for a fixed period of time not longer than 1 year. They don't apply if the same modifications are made to several vehicles.
- (2) The compliance with technical requirements of this UTP is deemed established when a basic parameter is kept unchanged or improved in the direction of the UTP defined performance and the entity managing the change demonstrates that the corresponding essential requirements are met and the safety level is maintained and, where reasonably practicable, improved.

~~0.1.1.2. Upgrade~~

~~The Contracting State~~

~~The Member State~~

~~shall use the following principles as a basis for determining the application of this~~

~~UTP~~

~~TSI~~

~~in case of upgrade:~~

- ~~(1) — Parts and basic parameters of the subsystem that have not been affected by the upgrading works are exempt from conformity assessment against the provisions in this~~

~~UTP.~~

~~TSI.~~

- ~~(2) — A new assessment against the requirements of this~~

~~UTP~~

~~TSI~~

~~is only needed for the basic parameters in this~~

~~UTP~~

~~TSI~~

~~which have their performance influenced by the modification(s).~~

- ~~(3) — When during the upgrade it is not economically feasible to fulfil the~~

~~UTP~~

~~TSI~~

~~requirement, the upgrade could be accepted if it is evident that a basic parameter is improved in the direction of the~~

~~UTP~~

~~TSI~~

~~defined performance.~~

~~In such a case the admission to international traffic of the unit shall be reconsidered by the application of ATMF Article 6 § 4.~~

 OTIF	Uniform Technical Prescription (UTP)		UTP LOC&PAS
	LOCOMOTIVES AND PASSENGER ROLLING STOCK		Page 204 of 272
Status: DRAFT	Version: 03	TECH-20041 Annex	Original: EN Date: 20.10.2020

~~(4) — Guidance to the~~

~~Contracting State~~

~~Member State~~

~~for those modifications that are deemed to be upgrades is given in the application guide.~~

~~(5) —~~

~~National migration strategies related to the implementation of other TSI (e.g. TSI covering fixed installations) may have an impact to what extent this TSI needs to be applied.~~

~~(6) — For a project including elements not being~~

~~UTP~~

~~TSI~~

~~conform, the procedures for the assessment of conformity and~~

~~UTP~~

~~EC~~

~~verification to be applied should be agreed with the~~

~~Contracting States concerned.~~

~~Member State.~~

~~In such a case the admission to international traffic of the unit shall be reconsidered by the application of ATMF Article 6 §4.~~

7.1.3 Rules related to the type or design examination certificates⁴⁷

7.1.3.1 Rolling stock subsystem

~~(1) — This clause concerns a rolling stock type (unit type in the context of this~~

~~UTP),~~

~~TSI),~~

~~as defined in~~

~~Article 2(w) of ATMF,~~

~~Article 2(w) of Directive 2008/57/EC,~~

~~which is subject to a~~

~~EC~~

~~type or design verification procedure in accordance with the section 6.2 of this~~

~~UTP.~~

~~TSI.~~

~~(2) — The~~

~~UTP~~

~~TSI~~

⁴⁷- [In EU law reference is made to the EC type or design examination certificate.](#)

 OTIF	Uniform Technical Prescription (UTP)		UTP LOC&PAS	
	LOCOMOTIVES AND PASSENGER ROLLING STOCK		Page 205 of 272	
Status: DRAFT	Version: 03	TECH-20041 Annex	Original: EN	Date: 20.10.2020

~~assessment basis for a ‘type or design examination’ is defined in columns 2 and 3 (design and development phase) of Appendix H of this~~

~~UTP.~~

~~TSI.~~

1) This point concerns the procedure referred to in Article 10 of ATMF according to which a Design Type Certificate related to a vehicle type and a Certificate of Operation related to a vehicle are granted.

This clause concerns a rolling stock type (unit type in the context of this TSI), as defined in Article 2(26) of Directive (EU) 2016/797, which is subject to a EC type or design verification procedure in accordance with the section 6.2 of this TSI. It also applies to the EC type or design verification procedure in accordance with the TSI Noise (Commission Regulation (EU) No 1304/2014), and the TSI PRM (Commission Regulation (EU) No 1300/2014) which refers to this TSI for its scope of application to Locomotives and Passenger rolling Stock.

2) The basis of assessment is defined in columns 2 and 3 ‘Design review’ and ‘Type test’ of Appendix H of this UTP.

The TSI assessment basis for a “EC type or design examination” is defined in columns 2 and 3 “Design review” and “Type test” of Appendix H of this TSI.

Phase A

3) Phase A starts at the moment an assessing entity is appointed (in case of private entity) or involved (in case of public entity) and ends when the Design Type Certificate is issued.

Phase A starts once a notified body, which is responsible for EC verification, is appointed by the applicant and ends when the EC type or design examination certificate is issued.

4) The assessment basis for a type is defined for a phase A period, with a duration of maximum seven years. During phase A, the applicable technical requirements shall not change, without prejudice to clauses 7.1.14 and 7.1.1.8 and point 5 below.

The TSI assessment basis for a type is defined for a phase A period, with a duration of maximum seven years. Without prejudice to clauses 7.1.1.4 to 7.1.1.8, during the phase A period the assessment basis for EC verification to be used by the notified body will not change.

5) When a revision of this UTP or of the UTP Noise or UTP PRM comes into force during the phase A period, it is permissible (but not mandatory) to use the revised version, either totally or for particular sections, unless explicitly otherwise specified in the revision of these UTPs; in case of application limited to particular sections, the applicant has to justify and document that applicable requirements remain consistent, and this has to be approved by the Competent Authority.

~~(3) — Phase A starts once~~

~~an assessing entity~~

~~which is responsible for~~

~~a notified body~~

 OTIF	Uniform Technical Prescription (UTP)		UTP LOC&PAS	
	LOCOMOTIVES AND PASSENGER ROLLING STOCK		Page 206 of 272	
Status: DRAFT	Version: 03	TECH-20041 Annex	Original: EN	Date: 20.10.2020

~~EC~~
~~verification, is appointed by the applicant and ends when the~~

~~EC~~
~~type examination certificate is issued.~~

~~(4) The UTP~~ | ~~The TSI~~

~~assessment basis for a type is defined for a phase A period, with a duration of maximum seven years. During the phase A period the assessment basis for~~

~~EC~~
~~verification to be used by the~~

~~assessing entity~~ | ~~notified body~~

~~will not change.~~

~~(5) When a revised version of this~~

~~UTP~~ | ~~TSI~~

~~comes into force during the phase A period, it is permissible (but not mandatory) to use the revised version, either totally or for particular sections; in case of application limited to particular sections, the applicant has to justify and document that applicable requirements remain consistent, and this has to be approved by the~~

~~assessing entity.~~ | ~~notified body.~~

Phase B

(6) Phase B starts at the moment the Design Type Certificate is issued by the competent authority. During the Phase B period, Certificates of Operation may be issued for vehicles complying with the Design Type Certificate.

The phase B period defines the period of validity of the EC type or design examination certificate once it is issued by the notified body. During this time, units may be EC certified on the basis of conformity to type.

(7) The Design Type Certificate is valid for seven year following the date it was issued. Modifications to this UTP or the UTP Noise or the UTP PRM shall not apply affect the validity of existing Design Type Certificates during the Phase B period, unless specified otherwise in these revised UTPs.

The EC type or design examination certificate of EC verification for the subsystem is valid for a seven year phase B period after its issue date, even if a revision of this TSI or of the TSI Noise or the TSI PRM comes into force, unless explicitly otherwise specified in the revision of these TSIs. During this period of validity, new rolling stock of the same type is permitted to be placed on the market on the basis of an EC declaration of



[verification referring to the type certificate of verification.](#)

~~(6) The phase B period defines the period of validity of the type examination certificate once it is issued by the~~

~~assessing entity.~~

~~notified body.~~

~~During this time, units may be~~

~~UTP~~

~~EC~~

~~certified on the basis of conformity to type.~~

~~(7) The type examination certificate of~~

~~UTP~~

~~EC~~

~~verification for the subsystem is valid for a seven year phase B period after its issue date, even if a revision of this~~

~~UTP~~

~~TSI~~

~~comes into force. During this time, new rolling stock of the same type is permitted to be placed in service on the basis of an~~

~~UTP~~

~~EC~~

~~declaration of verification referring to the type certificate of verification.~~

~~Modifications to a type or design already bearing an~~

~~UTP~~

~~EC~~

~~certificate of verification~~

~~(8) For modifications to a rolling stock type already bearing a type or design examination certificate of verification, the following rules apply:~~

~~— The changes are permitted to be dealt with by only re-assessing those modifications which influence the basic parameters of the latest revision of this~~

~~UTP~~

~~TSI~~

~~in force at that time.~~

~~— In order to establish the certificate of~~

~~UTP verification, the assessing entity~~

~~EC verification, the notified body~~

~~is permitted to refer to:~~

 OTIF	Uniform Technical Prescription (UTP)		UTP LOC&PAS	
	LOCOMOTIVES AND PASSENGER ROLLING STOCK		Page 208 of 272	
Status: DRAFT	Version: 03	TECH-20041 Annex	Original: EN	Date: 20.10.2020

~~The original type or design examination certificate for parts of the design that are unchanged, as far as it is still valid (during 7 years phase B period).~~

~~Additional type or design examination certificate (amending the original certificate) for modified parts of the design which influence the basic parameters of the latest revision of this~~

~~UTP~~

~~TSI~~

~~in force at that time.~~

7.1.3.2 Interoperability constituents

- (1) This clause concerns an interoperability constituent which is subject to type examination (module CB) or to suitability for use (module CV).

This clause only applies for ICs which are assessed separately from the subsystem.

- (2) The type or design examination or suitability for use certificate is valid for a five year period. During this time, new constituents of the same type are permitted to be placed into service without a new type assessment. Before the end of the five-year period, the constituent shall be assessed according to the latest revision of this

UTP

TSI

in force at that time, for those requirements that have changed or are new in comparison to the certification basis.

7.1.4 Rules for the extension of the area of use for existing rolling stock ~~having an authorisation in accordance with Directive 2008/57/EC or in operation before 19 July 2010~~

- (1) This clause sets out rules for the extension of the area of use of existing rolling stock which ~~is~~ are not in full compliance with this UTP.

In accordance with Article 10 § 4 of ATMF, where the applicant wishes to extend the area of use of a vehicle which has already been admitted to operation, it shall update the vehicle's documentation concerning this additional area of use and apply for the process defined in Article 6 § 4 of ATMF.

having an authorisation in accordance with Directive 2008/57/EC or in operation before 19 July 2010

In the absence of full conformity with this TSI, point 2 applies to rolling stock that fulfils the following conditions when requesting the extension of its area of use in accordance with Article 21(13) of Directive (EU) 2016/797:

- a. it has been authorised in accordance with Directive 2008/57/EC or put in operation before 19 July 2010;
- b. it is registered with "Valid" registration code "00", in the National Vehicle Register in accordance with Commission Decision

 OTIF	Uniform Technical Prescription (UTP)		UTP LOC&PAS	
	LOCOMOTIVES AND PASSENGER ROLLING STOCK		Page 209 of 272	
Status: DRAFT	Version: 03	TECH-20041 Annex	Original: EN	Date: 20.10.2020

(2) Extending the area of use of the rolling stock referred to in point 1 by complementary vehicle admission shall be based on the existing admission, if any, and on the technical compatibility between the rolling stock and the network(s) of the state(s) concerned and compliance with the Basic Design Characteristics of Table 17a and 17b of this UTP, taking into account any restrictions or limitations.

The applicant shall provide the Competent Authority with the technical certificates defined in Article 11 of ATMF, including all attachments and any other evidence of compliance with the requirements set out in this UTP

[2007/756/EC⁴⁸](#) or in the European Vehicle Register in accordance with Commission Implementing Decision (EU) 2018/1614⁴⁹ and maintained in a safe state of running in accordance with Commission Implementing Regulation (EU) 2019/779⁵⁰.

The following provisions for extension of area of use apply also in combination with a new authorisation as defined in point (a) of Article 14(3) of Regulation (EU) 2018/545.

Authorisation for an extended area of use of the rolling stock referred to in point 1 shall be based on the existing authorisation, if any, and on the technical compatibility between the rolling stock and the network in accordance with point (d) of Article 21(3) of Directive (EU) 2016/797 and compliance with the Basic Design Characteristics of Table 17a and 17b of this TSI, taking into account any restrictions or limitations.

The applicant shall provide an ‘EC’ declaration of verification’ accompanied by technical files giving evidence of compliance with the requirements set out in this TSI.

or with provisions having equivalent effect, for each basic parameter referred to in column 1 of Tables 17a and 17b and with the following clauses of this UTP:

- [4.2.4.2.2, 4.2.5.5.8, 4.2.5.5.9, 4.2.6.2.3, 4.2.6.2.4, 4.2.6.2.5, 4.2.8.2.7, 4.2.8.2.9.8 \(when running through phase or system separation sections is managed automatically\), 4.2.9.3.1, 4.2.9.6, 4.2.12 and 4.2.12.6](#)
- [4.2.5.3 in Italy](#)
- [4.2.5.3.5 and 4.2.9.2.1 in Germany](#)

through one or a combination of the following:

- [compliance with requirements set out in this UTP as referred above;](#)
- [compliance with corresponding requirements set out in a previous UTP as referred above;](#)

⁴⁸- [Commission Decision 2007/756/EC of 9 November 2007 adopting a common specification of the national vehicle register provided for under Articles 14\(4\) and \(5\) of Directives 96/48/EC and 2001/16/EC \(OJ L 305, 23.11.2007, p. 30\)](#)

⁴⁹- [Commission Implementing Decision \(EU\) 2018/1614 of 25 October 2018 laying down specifications for the vehicle registers referred to in Article 47 of Directive \(EU\) 2016/797 of the European Parliament and of the Council and amending and repealing Commission Decision 2007/756/EC \(OJ L 268, 26.10.2018, p. 53\)](#)

⁵⁰- [Commission Implementing Regulation \(EU\) 2019/779 of 16 May 2019 laying down detailed provisions on a system of certification of entities in charge of maintenance of vehicles pursuant to Directive \(EU\) 2016/798 of the European Parliament and of the Council and repealing Commission Regulation \(EU\) No 445/2011 \(OJ L 139 I, 27.5.2019, p. 360\)](#)

 OTIF	Uniform Technical Prescription (UTP)		UTP LOC&PAS	
	LOCOMOTIVES AND PASSENGER ROLLING STOCK		Page 210 of 272	
Status: DRAFT	Version: 03	TECH-20041 Annex	Original: EN	Date: 20.10.2020

- compliance with alternative specifications deemed to have equivalent effect to the relevant requirements set out in this UTP as referred above;
- evidence that the requirements for technical compatibility with the network of the extended area of use are equivalent to the requirements for technical compatibility with the network for which the rolling stock is already admitted or in operation. Such evidence shall ~~be provided by the applicant and may be based on the information of the register of railway infrastructure (RINF).~~

be provided by the applicant.

be provided by the applicant and may be based on the information of the register of railway infrastructure (RINF).

(3) The equivalent effect of alternative specifications to the requirements of this UTP (point 2(c)) and the equivalence of requirements for technical compatibility with the network (point 2(d)) shall be justified and documented by the applicant by applying the risk management process set out in Annex I of UTP GEN-G. The justification has to be assessed and confirmed by an assessment body in accordance with UTP GEN-G (CSM RA).

(4) In addition to the requirements mentioned ~~referred to~~ in point 2 and where applicable, the applicant shall provide

an 'EC' declaration of verification accompanied by technical files giving

evidence of compliance with the following:

- a. specific cases relating to any part of the extended area of use, listed ~~in~~ this UTP, the UTP Noise , or the UTP PRM or the equivalent TSIs ⁵¹. ~~, the TSI Noise (Regulation (EU) No 1304/2014), the TSI PRM (Regulation (EU) No 1300/2014) and CCS TSI (Regulation (EU) 2016/919);~~
- b. the national technical requirements in the meaning of Article 12 of APTU.

(5) (reserved)

The authorising entity shall make publicly available through the Agency website details of the alternative specifications referred to in point 2 (c) and of the requirements for technical compatibility with the network referred to in point 2 (d) on the basis of which it granted authorisations for the extended area of use.

(6) (reserved)

Where an authorised vehicle benefited from non-application of TSIs or part of them pursuant to Article 9 of Directive 2008/57/EC, the applicant shall seek derogation(s) in the Member States of the extended area of use in accordance to Article 7 of Directive (EU) 2016/797.

⁵¹ For Member States of the European Union, the specific cases are set out in the TSI Noise (Regulation (EU) No 1304/2014), the TSI PRM (Regulation (EU) No 1300/2014) and CCS TSI (Regulation (EU) 2016/919).

 OTIF	Uniform Technical Prescription (UTP)		UTP LOC&PAS	
	LOCOMOTIVES AND PASSENGER ROLLING STOCK		Page 211 of 272	
Status: DRAFT	Version: 03	TECH-20041 Annex	Original: EN	Date: 20.10.2020

- (7) [Article 19 of ATMF lays down transitional provisions for vehicles admitted to operation before 1 January 2011 which are marked RIC.](#)
- [Following a change which requires a new admission, coaches accepted under the latest RIC agreement shall keep the area of use in which they were operating, provided the change complies with point 7.1.2 of this UTP and -without further checks on the unchanged parts.](#)
- [In accordance with Article 54\(2\) of Directive \(EU\) 2016/797, coaches used under Regolamento Internazionale Carrozze \(RIC\) shall be deemed authorised in accordance with the conditions under which they were used, including the area of use where they are operated.](#)
- [Following a change which requires a new authorisation for placing on the market in accordance with Article 21\(12\) of Directive \(EU\) 2016/797, coaches accepted under the latest RIC agreement shall conserve the area of use in which they were operating without further checks on the unchanged parts.](#)

7.2 Compatibility with other subsystems

- (1) This

UTP

TSI

has been developed with consideration of other subsystems being compliant

with harmonised provisions developed in the European Union, which at the time of drafting have no mandatory equivalence at international level outside the EU.

to their respective TSI.

Accordingly, interfaces with the fixed installations infrastructure, energy and control-command subsystems are addressed for subsystems compliant with the Infrastructure TSI, the Energy TSI and the CCS TSI.

- (2) Following this, the implementation methods and phases concerning rolling stock depend on the progress of implementation of the

compatible infrastructure, in line with UTPs developed and applied for the subsystems which constitute the fixed installations of the rail system.

Infrastructure TSI, the Energy TSI and the CCS TSI.

- (3) The compatibility between rolling stock and fixed installations should be verified [before using a vehicle on a particular line](#). This is the responsibility of the railway undertaking. However, the railway undertaking must be able to rely on information provided to it from other entities, in particular the infrastructure manager.

Furthermore, TSI, covering the fixed installations allow for a set of different technical characteristics (e.g. “traffic code” in INF TSI, “power supply system” in ENE TSI).

- (4)

For rolling stock, the corresponding technical characteristics are recorded in the “European register of authorised types of vehicles”, according to Article ~~34~~[48](#) of Directive [\(EU\) 2016/797](#)~~2008/57/EC~~ and Commission Implementing Decision 2011/665/EU of 4

 OTIF	Uniform Technical Prescription (UTP)		UTP LOC&PAS	
	LOCOMOTIVES AND PASSENGER ROLLING STOCK		Page 212 of 272	
Status: DRAFT	Version: 03	TECH-20041 Annex	Original: EN	Date: 20.10.2020

(5)

October 2011 on the European register of authorised types of vehicles (see also section 4.8 of this TSI).

For fixed installations, they are part of the main features recorded in the “Register of infrastructure”, according to Article ~~35–48~~ of Directive [\(EU\) 2016/797](#)~~2008/57/EC~~ and Commission [Implementing Decision 2019/777](#)⁵²~~2011/633/EU~~ on the common specification of the register of railway infrastructure.

7.3 Specific cases

7.3.1 General

- (1) The specific cases, as listed in the following clause, describe special provisions that are needed and authorised on particular networks of each

Contracting State.

The specific cases for Member States of the European Union are those which are included in the TSI LOC&PAS.

Specific cases for Norway are those applicable for the LOC&PAS TSI as set out in Article 1(2) points (a) to (f) of the Decision of the EEA Joint Committee No 176/2012 of 28 September 2012 amending Annex XIII (Transport) to the EEA Agreement as published in the Official Journal of the European Union L 341, 13.12.2012, p. 29.

~~Member State.~~

- (2) These specific cases are classified as:

- “P” cases: “permanent” cases.
- ~~“T” cases: “temporary” cases, where it is planned that the target system is reached in the future.~~
- [“T0”: “temporary” cases of indefinite duration, where the target system shall be reached by a date still to be determined.](#)
- [“T1” cases: “temporary” cases, where the target system shall be reached by 31 December 2025.](#)
- [“T2” cases: “temporary” cases, where the target system shall be reached by 31 December 2035.](#)

[All specific cases and their relevant dates shall be re-examined in the course of future revisions of](#)

⁵²- [Commission Implementing Regulation \(EU\) 2019/777 of 16 May 2019 on the common specifications for the register of railway infrastructure and repealing Implementing Decision 2014/880/EU \[RINF\] \(OJ L 139 I, 27.5.2019, p. 312\).](#)

 OTIF	Uniform Technical Prescription (UTP)		UTP LOC&PAS
	LOCOMOTIVES AND PASSENGER ROLLING STOCK		Page 213 of 272
Status: DRAFT	Version: 03	TECH-20041 Annex	Original: EN Date: 20.10.2020

the TSI with a view to limiting their technical and geographical scope based on an assessment of their impact on safety, interoperability, cross border services, TEN-T corridors, and the practical and economic impacts of retaining or eliminating them. Special account shall be given to availability of EU funding.

Specific cases shall be limited to the route or network where they are strictly necessary and taken account of through route compatibility procedures.

(3) Any specific case applicable to the rolling stock in the scope of this

UTP	TSI
shall be addressed in this	

UTP.	TSI.
------	-----------------

(4) Certain specific cases are in interface to other

UTP.	TSI.
Where a clause in this	

UTP	TSI
refers to another	

UTP	TSI
to which a specific case is applicable, or where a specific case is applicable to the rolling stock as a consequence of a specific case declared in another	

UTP,	TSI,
these are also described in this	

UTP.	TSI.
------	-----------------

(5) Moreover, some specific cases do not prevent the access to the national network to

UTP	TSI
compliant rolling stock. In that case, it is explicitly stated in the concerned section of the clause 7.3.2 below.	

(6) In case of a specific case applicable to a component defined as interoperability constituent in section 5.3 of this UTP, the conformity assessment has to be made according to the clause 6.1.1 point (3).

 OTIF	Uniform Technical Prescription (UTP)		UTP LOC&PAS
	LOCOMOTIVES AND PASSENGER ROLLING STOCK		Page 214 of 272
Status: DRAFT	Version: 03	TECH-20041 Annex	Original: EN Date: 20.10.2020

7.3.2 List of specific cases

This section ~~only covers~~ sets out specific cases which are either not included in the LOC&PAS TSI (for Switzerland) or, which are set out in the TSI but and to the Great Britain⁵³ network of the United Kingdom.

Specific cases set out in the TSI which apply only to domestic traffic on the Great Britain network of the United Kingdom are reproduced in the right hand column⁵⁴.

7.3.2.1 Mechanical interfaces (4.2.2.2)

Specific Case United Kingdom (Great Britain) ("P")

Staff access for coupling and uncoupling (clause 4.2.2.2.5)

It is permissible for units fitted with manual coupling systems (as per clause 4.2.2.2.3 b) to alternatively comply with the national technical rules notified for this purpose.

This specific case does not prevent the access of UTP or TSI compliant rolling stock to the national network.

7.3.2.2 Gauging (4.2.3.1)

Specific Case United Kingdom (Great Britain) ("P")

For technical compatibility with the existing network it is permissible for the profile of the upper and the lower part of the unit together with the pantograph gauge to alternatively be established in accordance with the national technical rules notified for this purpose.

This specific case does not prevent the access of UTP or TSI compliant rolling stock to the national network.

7.3.2.3 Rolling stock requirements for compatibility with trackside equipment (4.2.3.2.2)

Specific Case United Kingdom (Great Britain) ("P")

It is permissible to establish the compatibility with trackside equipment other than that defined in the specification referenced in Annex J-1, index 15. In such a case, the characteristics of the trackside equipment the unit is compatible with shall be described in the technical documentation (in accordance with point (4) of clause 4.2.3.3.2).

7.3.2.4 Safety against derailment running on twisted track (4.2.3.4.1)

Specific Case United Kingdom (Great Britain) ("P")

⁵³- Specific cases which apply on the Northern-Ireland network of the United Kingdom and are set out in the TSI, as these are harmonised with the network of the Republic of Ireland. Specific cases which apply for the Channel Tunnel are set out in the TSI.

⁵⁴- Specific cases relevant for vehicles exclusively used in domestic traffic are not within the scope of the UTP.

 OTIF	Uniform Technical Prescription (UTP)		UTP LOC&PAS
	LOCOMOTIVES AND PASSENGER ROLLING STOCK		Page 215 of 272
Status: DRAFT	Version: 03	TECH-20041 Annex	Original: EN Date: 20.10.2020

It is permissible for all units and cases to use Method 3 set out in EN14363:2016 clause 6.1.5.3.1.

This specific case does not prevent the access of UTP or TSI compliant rolling stock to the national network.

7.3.2.5 Running dynamic behaviour (4.2.3.4.2, 6.2.3.4)

Specific Case United Kingdom (Great Britain) (“P”)

For technical compatibility with the existing network it is permissible to use national technical rules amending EN 14363 requirements and notified for the purpose of running dynamic behaviour. This specific case does not prevent the access of UTP or TSI compliant rolling stock to the national network.

7.3.2.6 Mechanical and geometric characteristics of wheelset and wheel (4.2.3.5.2.1 and 4.2.3.5.2.2)

Specific Case United Kingdom (Great Britain) (“P”)

It is permissible for the geometrical dimensions of the wheels to alternatively be established in accordance with the national technical rule notified for this purpose.

This specific case does not prevent the access of UTP or TSI compliant rolling stock to the national network.

7.3.2.7 Emergency braking (4.2.4.5.2)

Specific Case United Kingdom (Great Britain) (“P”)

It is permissible for units assessed in fixed or predefined formation of design maximum speed higher or equal to 250 km/h, for the stopping distance in case of ‘emergency braking performance in normal mode’ to deviate from the minimum values specified in point (9) of clause 4.2.4.5.2.

7.3.2.8 Head pressure pulse (4.2.6.2.2):

Specific Case United Kingdom (Great Britain) (“P”)

Units with a maximum operating speed higher than 160 km/h and lower than 250 km/h, running in the open air at their maximum operating speed shall not cause the maximum peak-to-peak pressure of changes to exceed a value as indicated in the national technical rule notified for this purpose.

~~7.3.2.4~~ 7.3.2.9 Maximum pressure variations in tunnels (4.2.6.2.3):

Specific Case Switzerland (“P”)

Vehicles for passenger service designed to operate at speed higher than 160 km/h and intended to be used in long single-track tunnels constructed with a cross-section of 41 m² shall be verified by means of a test run.

The requirements applicable for this specific case shall be forwarded to the CTE by Switzerland according to the results of the type test runs scheduled in 2015 in the Gotthard base tunnel. Consecutively this UTP will be updated as necessary.

If the vehicle does not fulfil these requirements, operating rules (e.g. speed restrictions) may apply.



7.3.2.10 Warning horn sound pressure levels (4.2.7.2.2)

Specific Case United Kingdom (Great Britain) (“P”)

(reserved)

Vehicle for national use only may be compliant with the horn sound pressure levels as stipulated in the national technical rules notified for this purpose.

Trains intended for international use shall be compliant with the horn sound pressure levels as specified in clause 4.2.7.2.2 of this TSI.

This specific case does not prevent the access of TSI compliant rolling stock to the national network.

7.3.2.11 Power supply – general (4.2.8.2)

Specific Case United Kingdom (Great Britain) (“P”)

(reserved)

It is permissible for electric units to be designed only for operation on lines equipped with the electrification system operating at 600/750 V DC as set out in the TSI ENE clause 7.4.2.9.1 and utilising ground level conductor rails in a three and/or four rail configuration; in that case the national technical rules notified for this purpose shall apply.

7.3.2.12 Operation within range of voltages and frequencies (4.2.8.2.2)

Specific Case United Kingdom (Great Britain) (“P”)

It is permissible for electric units to be equipped with automatic regulation within abnormal operation condition regarding voltage as set out in the national technical rule notified for this purpose.

This specific case does not prevent the access of UTP or TSI compliant rolling stock to the national network.

7.3.2.13 Height of interaction with contact wires (RST level) (4.2.8.2.9.1.1)

Specific Case United Kingdom (Great Britain) (“P”)

For technical compatibility with existing lines, the installation of a pantograph on an electric unit shall allow mechanical contact of the contact wires at the extended range of wire heights in accordance with the national technical rules notified for this purpose.

 OTIF	Uniform Technical Prescription (UTP)		UTP LOC&PAS
	LOCOMOTIVES AND PASSENGER ROLLING STOCK		Page 217 of 272
Status: DRAFT	Version: 03	TECH-20041 Annex	Original: EN
			Date: 20.10.2020

7.3.2.27.3.2.14 Pantograph head geometry (IC level) (4.2.8.2.9.2)

Specific Case Switzerland (“P”)

For operation on existing lines the electric units have to be equipped with a pantograph having a head geometry length of 1450 mm, unless specified otherwise in the infrastructure register. (EN 50367:2012 Annex B2, Figure B.1)

Specific Case United Kingdom (Great Britain) (“P”)

For operation on the existing network, it is allowed to equip electric units with a pantograph having a head geometry of length 1 600 mm as depicted in EN 50367:2012, Annex B.2 figure B.6 (as alternative to requirement in clause 4.2.8.2.9.2).

7.3.2.37.3.2.15 Pantograph contact force and dynamic behaviour (4.2.8.2.9.6)

Specific Case Switzerland (“P”)

For operation on existing lines requiring a head geometry length of 1450 mm, the pantograph and overhead contact lines must work properly together in all operating configurations and at the speed range used. (EN 50367:2012, Annex B, table B.1 and table B.5 and fig. B.1; Annex C, table C.1)

Specific Case United Kingdom (Great Britain) (“P”)

For technical compatibility with existing lines, the verification at interoperability constituent level (clause 5.3.10 and 6.1.3.7.) shall validate capability of the pantograph to collect current for the additional range of contact wire heights between 4 700 mm and 4 900 mm.

7.3.2.16 Driver’s cab emergency exit (4.2.9.1.2.2)

Specific Case United Kingdom (Great Britain) (“P”)

It is permissible for the interior exit to have a minimum access area and a minimum clearance of height and width, in accordance with the national technical rules notified for this purpose.

This specific case does not prevent the access of UTP or TSI compliant rolling stock to the national network.

7.3.2.17 Front visibility ((4.2.9.1.3.1)

Specific Case United Kingdom (Great Britain) (“P”)

Instead of the requirements set out in 4.2.9.1.3.1, for rolling stock intended for operation in the UK, the following specific case shall be complied with.

The driver’s cab shall be designed to allow the driver at his seated driving position a clear and unobstructed line of sight in order to distinguish fixed signals in accordance with the national technical rule, GM/RT2161 ‘Requirements for driving cabs of railway vehicles’.

This specific case does not prevent the access of UTP or TSI compliant rolling stock to the national network.

 OTIF	Uniform Technical Prescription (UTP)		UTP LOC&PAS	
	LOCOMOTIVES AND PASSENGER ROLLING STOCK		Page 218 of 272	
Status: DRAFT	Version: 03	TECH-20041 Annex	Original: EN	Date: 20.10.2020

7.3.2.18 Driver's desk – Ergonomics (4.2.9.1.6)

Specific Case United Kingdom (Great Britain) ("P")

In case the requirements in clause 4.2.9.1.6, last paragraph, related to the direction of movement of the lever for traction and/or braking is incompatible with the safety management system of the railway undertaking operating in Great Britain, it is allowed to inverse the direction of movement for braking and traction respectively.

7.3.2.19 Special requirements for stabling of trains (4.2.11.6)

Specific Case United Kingdom (Great Britain) ("P")

It is permissible for the local external auxiliary power supply 400 V to be provided in accordance with the national technical rules notified for this purpose.

7.3.2.20 Rules to manage changes in both rolling stock and rolling stock type (7.1.2.2)

Specific Case United Kingdom (Great Britain) ("P")

Any change to a vehicle swept envelope as defined in the national technical rules notified for the gauging process (for example as described in RIS-2773-RST)

shall be considered as category 3 as defined in point 7.1.2.2 (3).

will be categorised as 15(1) (c) of Commission Implementing Regulation (EU) 2018/545, and will not be classified as 21(12)(a) of Directive (EU) 2016/797.

7.4 Specific environmental conditions

Specific conditions Austria

Unrestricted access in Austria under winter conditions is granted if the following conditions are met:

- The additional capability of the obstacle deflector to remove snow as specified for snow, ice and hail severe conditions in clause 4.2.6.1.2 shall be provided.
- Locomotives and power head units shall be provided with sanding devices.

Specific conditions Estonia

For unrestricted access of rolling stock on the Estonia network under winter conditions, it shall be demonstrated that the rolling stock meets the following requirements:

- Temperature zone T2 as specified in clause 4.2.6.1.2 shall be selected.
- Snow, ice and hail severe conditions as specified in clause 4.2.6.1.2, excluding the scenario 'Snowdrift' shall be selected.

Specific conditions Finland

For unrestricted access of rolling stock on the Finnish network under winter conditions, it shall be demonstrated that the rolling stock meets the following requirements:

 OTIF	Uniform Technical Prescription (UTP)		UTP LOC&PAS	
	LOCOMOTIVES AND PASSENGER ROLLING STOCK		Page 219 of 272	
Status: DRAFT	Version: 03	TECH-20041 Annex	Original: EN	Date: 20.10.2020

- Temperature zone T2 as specified in clause 4.2.6.1.1 shall be selected
- Snow, ice and hail severe conditions as specified in clause 4.2.6.1.2, excluding the scenario “Snowdrift” shall be selected
- Regarding the braking system, unrestricted access in Finland under winter conditions is granted if the following conditions are met:
 - at least half of the bogies are equipped with a magnetic track brake for trainset or passenger coach of nominal speed exceeding 140 km/h.
 - all bogies are equipped with a magnetic track brake for trainset or passenger coach of nominal speed exceeding 180 km/h.

Specific conditions France

Unrestricted access in France under winter conditions is granted if the following condition is met:

- locomotives and power head units shall be provided with sanding devices.

Specific conditions Greece

For unrestricted access to the Greek network under summer conditions, temperature zone T3 as specified in clause 4.2.6.1.1 shall be selected.

Specific conditions Germany

Unrestricted access in Germany under winter conditions, is granted if the following condition is met:

- locomotives and power head units shall be provided with sanding devices.

Specific conditions Portugal

For unrestricted access to the Portuguese network under summer conditions, temperature zone T3 as specified in clause 4.2.6.1.1 shall be selected.

Specific conditions Spain

For unrestricted access to the Spanish network under summer conditions, temperature zone T3 as specified in clause 4.2.6.1.1 shall be selected.

Specific conditions Sweden

For unrestricted access of rolling stock on the Swedish network under winter conditions, it shall be demonstrated that the rolling stock meets the following requirements:

- Temperature zone T2 as specified in clause 4.2.6.1.1 shall be selected
- Snow, ice and hail severe conditions as specified in clause 4.2.6.1.2 shall be selected

Specific conditions Switzerland

For unrestricted access in Switzerland under winter conditions the additional capability of the obstacle deflector to remove snow as specified for snow, ice

 OTIF	Uniform Technical Prescription (UTP)		UTP LOC&PAS	
	LOCOMOTIVES AND PASSENGER ROLLING STOCK		Page 220 of 272	
Status: DRAFT	Version: 03	TECH-20041 Annex	Original: EN	Date: 20.10.2020

and hail severe conditions in clause 4.2.6.1.2 shall be provided.

7.5 Aspects that have to be considered in the revision process

or in other activities of the Agency

The EU has identified aspects of interest for the future development of the EU railway system

Further to the analysis performed during the drafting process of this TSI, particular aspects have being identified as of interest for the future development of the EU railway system

These aspects are of 3 different groups:

- (1) Those already subject of a basic parameter in this

UTP,

~~TSI~~

with a possible evolution of the corresponding specification when the

UTP

~~TSI~~

will be revised.

- (2) Those not considered in the current state of the art as basic parameter, but which are subject to research projects.

- (3) Those relevant in the framework of on-going studies related to the

EU

railway system, which are not in the scope of

UTP.

~~TSI~~

These aspects are identified below, classified according to the breakdown of the clause 4.2 of the [UTP](#)~~TSI~~.

7.5.1 Aspects related to a basic parameter in this

UTP

~~TSI~~

7.5.1.1 Axle load parameter (clause 4.2.3.2.1)

This basic parameter covers the interface between infrastructure and rolling stock regarding the vertical load.

In the EU,

According to the INF TSI,

the lines are classified as specified in the standard EN 15528:2008. This standard specifies also a categorization of railway vehicles, for freight wagons and particular types of locomotives and passenger vehicles; it will be revised to cover all types of rolling stock, and to cover HS lines.

 OTIF	Uniform Technical Prescription (UTP)		UTP LOC&PAS	
	LOCOMOTIVES AND PASSENGER ROLLING STOCK		Page 221 of 272	
Status: DRAFT	Version: 03	TECH-20041 Annex	Original: EN	Date: 20.10.2020

When this revision will be available, it may be of interest to include in the

UTP certificate issued by the assessing entity

~~EC certificate delivered by the notified body~~

the “design” classification of the unit under assessment:

- Classification corresponding to the design mass under normal payload.
- Classification corresponding to the design mass under exceptional payload.

This aspect will have to be considered when revising this

UTP,

~~TSI~~

which already requires in its present version to record all data necessary to determine these classifications.

It has to be noted that the requirement to the railway undertaking to define and control the operational load,

as specified in the clause 4.2.2.5 of the OPE TSI

will remain unchanged.

7.5.1.2 Aerodynamic effects - Cross wind (clause 4.2.6.2.4)

Requirements on “cross wind” have been set up for units of maximum design speed equal to or higher than 250 km/h

with 2 options:

- in consistency with the HS RST TSI, or
- in consistency with the CR LOC&PAS TSI.

This will need to be reviewed when the merging of the 2 sets of characteristics wind curves

specified in the HS RST TSI

will be finalised.

7.5.1.3 [Aerodynamic effects on ballasted tracks \(clause 4.2.6.2.5\)](#)

[Requirements on aerodynamic effects on ballasted tracks have been set up for units of maximum design speed higher than 250 km/h.](#)

[As the current state of the art does not allow to provide for a harmonized requirement nor assessment methodology, the UTP allows the application of national rules.](#)

[This will need to be reviewed in order to consider the following:](#)

- [Study of ballast-pick-up occurrences, and corresponding safety impact \(if any\)](#)
- [Development of a harmonized, cost-effective methodology applicable in EU.](#)

 OTIF	Uniform Technical Prescription (UTP)		UTP LOC&PAS	
	LOCOMOTIVES AND PASSENGER ROLLING STOCK		Page 222 of 272	
Status: DRAFT	Version: 03	TECH-20041 Annex	Original: EN	Date: 20.10.2020

7.5.2 Aspects not related to a basic parameter in this

UTP

~~TSI~~

but subject to research projects

7.5.2.1 Additional requirements for security reasons

The interior of vehicles interfacing with passengers and train crew should provide protection of the occupants in the event of a collision by providing means of:

- minimising the risk of injury due to secondary impact with such furniture and interior fixtures and fittings
- minimising those injuries that may preclude subsequent escape

Some EU research projects have been launched in 2006 to study the consequence of railway accidents (collision, derailment...) on passengers, to evaluate in particular the risk and level of injuries; the objective is to define requirements and corresponding conformity assessment procedures related to the railway vehicles interior layouts and components.

This

UTP

~~TSI~~

already provides a number of specifications in order to cover such risks, for example, sections 4.2.2.5, 4.2.2.7, 4.2.2.9 and 4.2.5.

More recently, studies have been launched at Member State level and at European level (by the Commission joint research centre) regarding the protection of the passengers in the event of terrorist attack.

The OTIF Secretariat

The Agency will follow these studies, and

will consider their outcome to define if additional basic parameters or requirements covering the risk of injuries of passengers in case of accident or terrorist attack shall be recommended to the

Committee of Technical Experts (CTE).

Commission.

Where appropriate this

UTP

~~TSI~~

shall be amended.

Pending the revision of this

the UTP Contracting States

~~TSI Member States~~

may use national rules to cover such risks. In any case this shall not prevent the access of

UTP

~~TSI~~

compliant rolling stock operating across

Contracting States'

~~Member States~~

 OTIF	Uniform Technical Prescription (UTP)		UTP LOC&PAS	
	LOCOMOTIVES AND PASSENGER ROLLING STOCK		Page 223 of 272	
Status: DRAFT	Version: 03	TECH-20041 Annex	Original: EN	Date: 20.10.2020

borders onto their national network.

(reserved)

7.5.2.2 Conditions for having an authorization for placing on the market not limited to particular networks

In order to facilitate free circulation of locomotives and passenger coaches, conditions for having an authorization for placing on the market not limited to particular networks have been developed during the preparation of ERA recommendation ERA-REC-111-2015-REC of 17 December 2015.

These provisions should be further developed to adapt them to Directive (EU) 2016/797 and to take into account the cleaning up of national technical rules, with particular focus on passenger coaches.

7.5.2.3 Rules for implementation

On 24 January 2020 the Commission sent a request to the European Union Agency for Railways for the preparation of the Digital rail and Green freight TSI revision package (2022 revision).

Pursuant to Commission Delegated Decision (EU) 2017/1474, the Digital rail and Green freight TSI revision package shall include provisions reviewing and if possible simplifying the strategy for the application of the TSIs in a way ensuring a gradual, but timely reduction of the divergences from the target system while providing the predictability and legal certainty necessary to the sector. These provision shall cover future transition periods as well as the issue of the validity period of the certificates for interoperability constituents and subsystems.

Furthermore, with the same objective of ensuring a gradual, but timely reduction of the divergences from the target system while providing the predictability and legal certainty necessary to the sector, provisions providing flexibility in the application of updated versions of standards shall be considered, including for those introduced in

 OTIF	Uniform Technical Prescription (UTP)		UTP LOC&PAS	
	LOCOMOTIVES AND PASSENGER ROLLING STOCK		Page 224 of 272	
Status: DRAFT	Version: 03	TECH-20041 Annex	Original: EN	Date: 20.10.2020

[Annex IV \(LOC&PAS 2019 TSI\) to Commission Implementing Regulation \(EU\) 2019/776⁵⁵.](#)

7.5.3 Aspects relevant for the EU railway system but out of the scope of

UTPs

TSI's

7.5.3.1 Track interaction (clause 4.2.3) - Flange or track lubrication

During the drafting process of this

UTP,

~~TSI,~~

it has been concluded that the “flange or track lubrication” is not a basic parameter (no link to essential requirements as defined

UTP GEN-A.

in the Directive [\(EU\) 2016/797](#)).

Nevertheless, it appears that the actors of the railway sector

(IM, RU, Competent Authority)

~~(IM, RU, NSA)~~

need a support ~~from~~

~~The OTIF Secretariat.~~

[from](#) The Agency

in order to move from the current practices to an approach that will ensure transparency and will avoid any unjustified barrier to the circulation of rolling stock on the

~~EU~~

network.

To that end, the Agency has suggested to launch a study together with the railway sector, with the objective to clarify the key technical and economic aspects of this function, considering the current situation:

1. Lubrication is required by some infrastructure managers, but also forbidden by others.
2. Lubrication may be provided by means of fixed installation designed by the infrastructure manager or by means of on board device to be provided by the railway undertaking.
3. Different ways of lubrication have been investigated by the railway sector.
4. Environmental aspects have to be considered when releasing grease along the track.

~~The OTIF Secretariat will follow these developments.~~

In any case, it is planned to include in the “Infrastructure register” information on “flange or rail lubrication”, and the “European register of

⁵⁵- [Commission Implementing Regulation \(EU\) 2019/776 of 16 May 2019 amending Commission Regulations \(EU\) No 321/2013, \(EU\) No 1299/2014, \(EU\) No 1301/2014, \(EU\) No 1302/2014, \(EU\) No 1303/2014 and \(EU\) 2016/919 and Commission Implementing Decision 2011/665/EU as regards the alignment with Directive \(EU\) 2016/797 of the European Parliament and of the Council and the implementation of specific objectives set out in Commission Delegated Decision \(EU\) 2017/1474 \(OJ L 139 I, 27.5.2019, p.108\)](#)

 OTIF	Uniform Technical Prescription (UTP)		UTP LOC&PAS	
	LOCOMOTIVES AND PASSENGER ROLLING STOCK		Page 225 of 272	
Status: DRAFT	Version: 03	TECH-20041 Annex	Original: EN	Date: 20.10.2020

authorised types of vehicles” will mention if the rolling stock is fitted with on-board flange lubrication. The study mentioned above will clarify operating rules.

In the meantime, Member States may continue to use national rules in order to cover this issue of the vehicle-track interface. Those rules shall be made available either through notification to the Commission in accordance with article 174 of Directive (EU) 2016/797~~2008/57/EC~~ or through the Infrastructure Register referred to in article ~~49~~³⁵ of the same Directive.

 OTIF	Uniform Technical Prescription (UTP)		UTP LOC&PAS
	LOCOMOTIVES AND PASSENGER ROLLING STOCK		Page 226 of 272
Status: DRAFT	Version: 03	TECH-20041 Annex	Original: EN Date: 20.10.2020

APPENDICES

- Appendix A** : ~~Intentionally deleted~~ ~~Buffer and draw gear~~ (reserved)
- Appendix B** : 1520 mm system gauge “T”.
- Appendix C** : Special provisions for mobile railway infrastructure construction and maintenance equipment
- Appendix D** : ~~Intentionally deleted~~ ~~Energy meter~~ [Reference wagon for locomotives fitted with automatic end centre buffer couplers and capable of a traction effort at coupling higher than 300 kN](#)
- Appendix E** : Anthropometric measurements of the driver
- Appendix F** : Front visibility
- Appendix G** : Servicing
- Appendix H** : Assessment of the rolling stock subsystem
- Appendix I** : List of aspects for which the technical specification is not available (open points)
- Appendix J** : List technical specifications referred to in this

UTP

~~TSI~~

Appendix J-1: List of standards or normative documents.

Appendix J-2: List of technical documents available on ERA website.

Appendix K: provisions for the safe operation of rolling stock.

 OTIF	Uniform Technical Prescription (UTP)		UTP LOC&PAS	
	LOCOMOTIVES AND PASSENGER ROLLING STOCK		Page 227 of 272	
Status: DRAFT	Version: 03	TECH-20041 Annex	Original: EN	Date: 20.10.2020

APPENDIX A ~~BUFFERS AND SCREW COUPLING SYSTEM~~

(reserved)

A.1. Buffers

~~When buffers are fitted to a unit end, they shall be paired (i.e. symmetrical and opposite handed) and have the same characteristics.~~

~~The height of the centre line of the buffers shall be between 980 mm and 1065 mm above rail level in all loading and wear conditions.~~

~~For car carriers under maximum load and locomotives, the minimum height of 940 mm is allowed.~~

~~The standard distance between buffer centrelines shall be nominally:~~

- ~~— on 1435 mm track gauge: 1750 mm \pm 10 mm symmetrically about the centreline of the vehicle.~~
- ~~— It is permitted for dual gauge units intended for running between standard gauge network 1435 mm and broad gauge networks to have a different value of the distance between buffer centrelines (e.g. 1850 mm), provided that full compatibility with buffers for standard 1435 mm gauge is ensured.~~
- ~~— on 1524 mm track gauge: 1830 mm (+/- 10 mm)~~
- ~~— on 1600 mm track gauge: 1905 mm (+/- 3 mm).~~
- ~~— on 1668 mm track gauge: 1850 mm \pm 10 mm symmetrically about the centreline of the vehicle, taking into account the particular provisions defined in clause 6.2.3.1 of the specification referenced in Annex J 1, index 67~~

~~Buffers shall be sized so that in horizontal curves and reverse curves, it is not possible for vehicles to lock buffers. The minimum horizontal overlap between buffer heads in contact shall be 25 mm.~~

~~Assessment test:~~

~~The determination of the buffer size has to be made with two vehicles going through a S-curve of 190 m radius without intermediate straight section and in a S-curve of 150 m radius with intermediate straight section of at least 6 m.~~

A.2. Screw coupling

~~The standard screw coupling system between vehicles shall be non-continuous and comprise of a screw coupling permanently attached to the hook, a draw hook and a draw bar with an elastic system.~~

~~The height of the centre line of the draw hook shall be between 950 mm and 1045 mm above rail level in all loading and wear conditions.~~

~~For car carriers under maximum load and locomotives, the minimum height of 920 mm is allowed. The maximum height difference between new wheels with design mass in working order and fully worn wheels with design mass under normal design payload shall not exceed 85 mm for the same vehicle. Assessment shall be done by calculation.~~

 OTIF	Uniform Technical Prescription (UTP)		UTP LOC&PAS	
	LOCOMOTIVES AND PASSENGER ROLLING STOCK		Page 228 of 272	
Status: DRAFT	Version: 03	TECH-20041 Annex	Original: EN	Date: 20.10.2020

~~Each vehicle end shall have a facility for supporting a shackle when it is not in use. No part of the coupler assembly shall reach below 140 mm above rail level in the lowest admissible position of the buffers.~~

- ~~— Screw coupling, draw hook and draw gear dimensions and characteristics shall be according to the specification referenced in Annex J-1, index 68~~
- ~~— The maximum weight of the screw coupling shall not exceed 36 kg, not including the weight of the coupling hook pin (item no.1 on fig. 4 and 5 of the specification referenced in Annex J-1, index 68).~~

~~A.3. Interaction of draw and buffing gear~~

- ~~— Static characteristics of draw gears and buffers shall be coordinated in order to ensure that a train is able to negotiate curves of the minimum radius defined in clause 4.2.3.6 of this~~

~~UTP~~

~~TSI~~

~~safely in normal coupling conditions (e.g. without locking buffers, etc.)~~

- ~~— Screw coupling and buffing gear layout:~~

~~The distance between the front edge of a draw hook opening and the front side of the fully extended buffers shall be 355 mm +45 / - 20 mm in the new condition as shown in fig. A1.~~

~~Structures and mechanical parts~~

~~Buffers~~

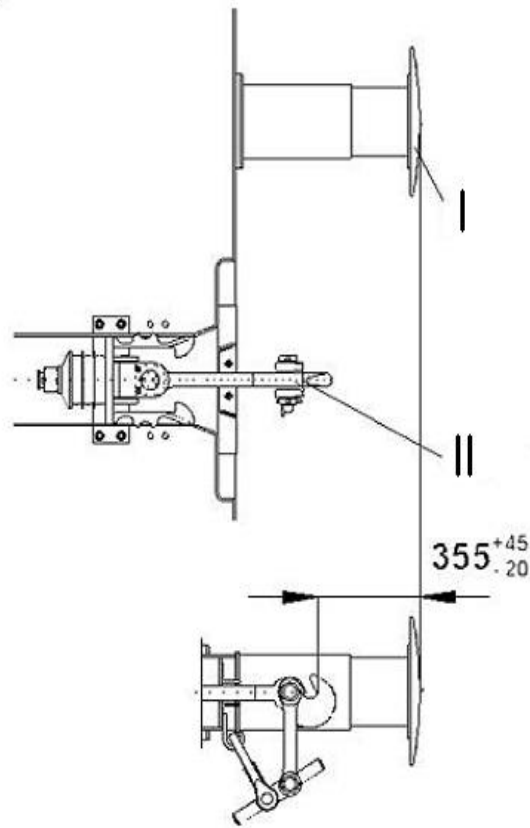

Fig. A1 Draw gear and buffers

I Fully extended buffer

II Draw hook opening



APPENDIX B

1520 mm system gauge "t"

Reference profile for the track gauge 1520,,T" of the upper parts (for rolling stock)

Running surface

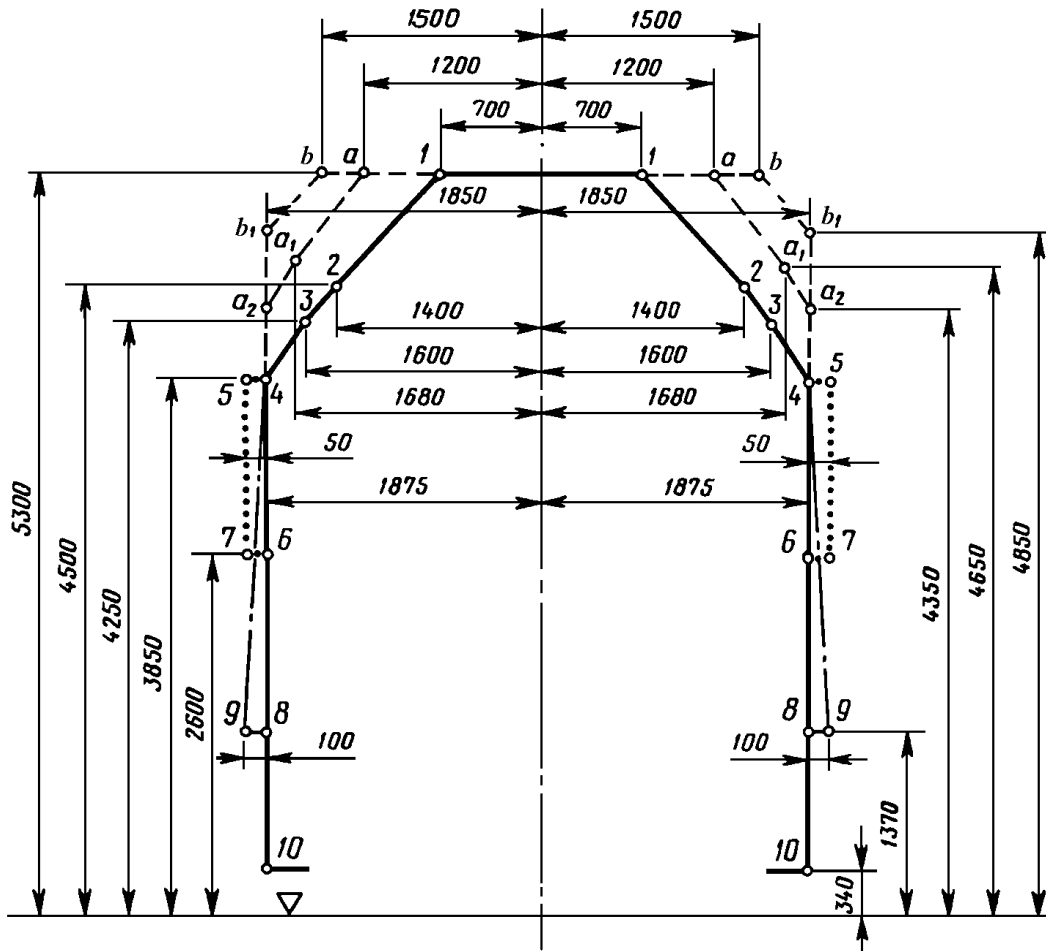

DIMENSIONS IN MILIMETRES

••••• zone for signals installed of the vehicle



Reference profile for the lower parts

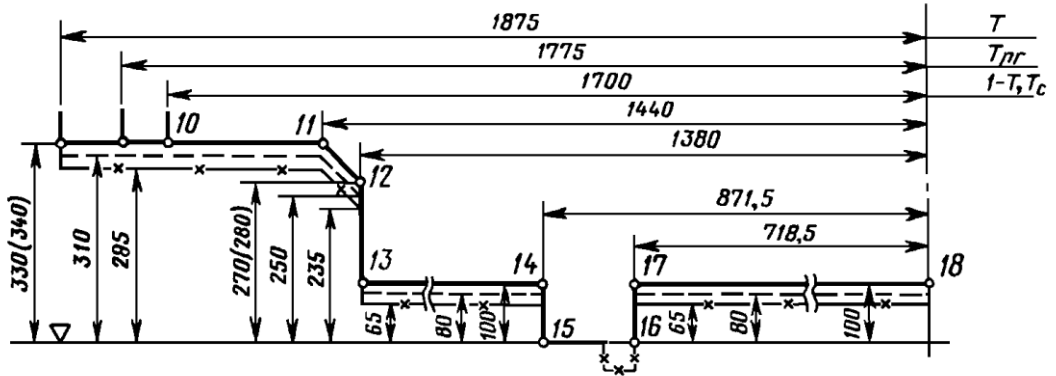

Note: For the rolling stock which is intend to be used on track of 1520mm, with the exception to pass over of marshalling humps equipped with rail brakes.

Reference profile for the lower parts

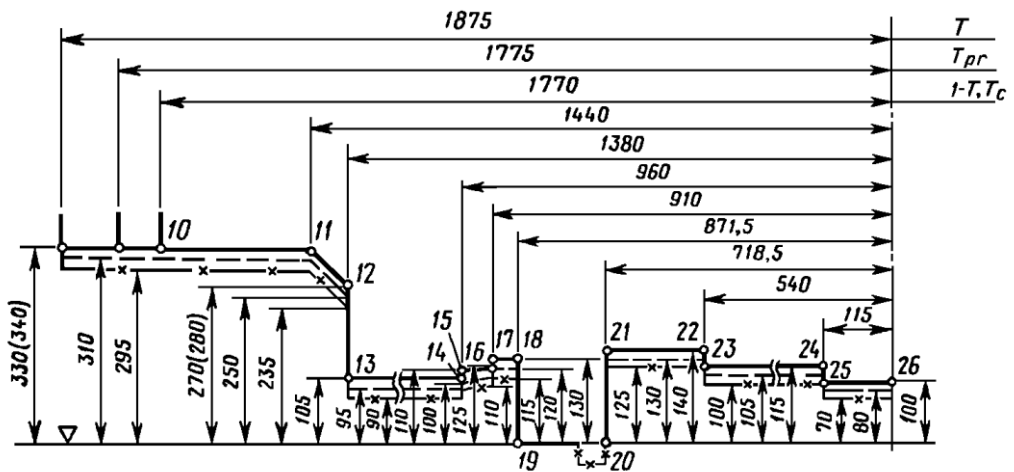

Note: For the rolling stock which is intend to be used on track of 1520 mm, able to pass over marshalling humps and rail brakes.

 OTIF	Uniform Technical Prescription (UTP)		UTP LOC&PAS	
	LOCOMOTIVES AND PASSENGER ROLLING STOCK		Page 232 of 272	
Status: DRAFT	Version: 03	TECH-20041 Annex	Original: EN	Date: 20.10.2020

APPENDIX C SPECIAL PROVISIONS FOR ON TRACK MACHINES (OTM)

C.1 Strength of vehicle structure

The requirements of the clause 4.2.2.4 of this

UTP

~~TSI~~

are complemented as follow:

The machine frame shall be able to withstand either the static loads of the specification referenced in Annex J-1, index 7 or the static loads according to the specification referenced in Annex J-1, index 102 without exceeding the permissible values given there in.

The corresponding structural category of the specification referenced in Annex J-1, index 102 is as follows:

- for machines not permitted to be loose shunted or hump shunted: F-II;
- for all other machines: F-I.

The acceleration in x-direction according to the specification referenced in Annex J-1, index 7, Table 13 or to the specification referenced in Annex J-1, index 102, Table 10 shall be ± 3 g.

C.2 Lifting and jacking

The machine body shall incorporate lifting points by which the whole machine is capable of being safely lifted or jacked. The location of the lifting and jacking points shall be defined.

To facilitate the work during repair or inspection or when on-tracking the machines, the machines shall be provided on both long sides with at least two lifting points, at which the machines can be lifted in empty or loaded condition.

To allow positioning of jacking devices, clearances shall be provided under the lifting points which shall not be blocked by the presence of non removable parts. The load cases shall be consistent with the ones chosen in Appendix C.1 of this

UTP

~~TSI~~

and shall apply for lifting and jacking under workshop and servicing operations.

C.3 Running dynamic behaviour

The running characteristics are permitted to be determined by running tests or by reference to a similar type approved machine as detailed in clause 4.2.3.4.2 of this

UTP

~~TSI~~

 OTIF	Uniform Technical Prescription (UTP)		UTP LOC&PAS	
	LOCOMOTIVES AND PASSENGER ROLLING STOCK		Page 233 of 272	
Status: DRAFT	Version: 03	TECH-20041 Annex	Original: EN	Date: 20.10.2020

or by simulation.

The following additional deviations from the specification referenced in Annex J-1, index 16 apply:

- The test shall always be taken as the simplified method for this type of machines
- when running tests according to the specification referenced in Annex J-1, index 16 are done with wheel profile in new condition, these are valid for a maximum distance of 50 000 km. After 50 000 km it is necessary to:
 - either re-profile the wheels;
 - or calculate the equivalent conicity of the worn profile and check that it does not differ more than 50 % from the value of the test of the specification referenced in Annex J-1, index 16 (with a maximum difference of 0,05);
 - or make a new test according to the specification referenced in Annex J-1, index 16 with worn wheel profile;
- in general, stationary tests to determine the parameters of characteristic running gear in accordance with to the specification referenced in Annex J-1, index 16, clause 5.3.14.3.2 are not necessary;
- if the required test speed cannot be obtained by the machine itself, the machine shall be hauled for the tests.

~~when test zone 3 (as described in table 9 of to the specification referenced in Annex J-1, index 16) is used it is sufficient to have a minimum of 25 conformant track sections.~~

Running behaviour can be proven by simulation of the tests described in to the specification referenced in Annex J-1, index 16 (with the exceptions as specified above) when there is a validated model of representative track and operating conditions of the machine.

A model of a machine for simulation of running characteristics shall be validated by comparing the model results against the results of running tests when the same input of track characteristic is used.

A validated model is a simulation model that has been verified by an actual running test that excites the suspension sufficiently and where there is a close correlation between the results of the running test and the predictions from the simulation model over the same test track.

 OTIF	Uniform Technical Prescription (UTP)		UTP LOC&PAS	
	LOCOMOTIVES AND PASSENGER ROLLING STOCK		Page 234 of 272	
Status: DRAFT	Version: 03	TECH-20041 Annex	Original: EN	Date: 20.10.2020

APPENDIX D

ON-BOARD ENERGY MEASUREMENT SYSTEM

1. Requirements for on-board energy measuring system (EMS) – System requirements

The functions of the system shall be:

- Energy measurement function (EMF), measuring the voltage and current, calculating the energy and producing energy data.
- Data handling system (DHS), producing compiled energy billing data sets for energy billing purposes, by merging data from the EMF with time data and geographical position, and storing it to be sent to on-ground data collection system (DCS) by a communication system.
- On board location function, giving geographical position of the traction unit.

~~Where data coming from the on-board location function is not necessary for billing purposes in the~~

~~Contracting State~~

~~Member State~~

~~concerned, it is permissible to not install the components dedicated to that function. In any case, any such EMS system shall be produced with consideration of the possible future inclusion of a location function.~~

~~The functions above may be performed by individual devices or may be combined in one or more integrated assemblies.~~

~~The above mentioned functions and their data flow diagram are illustrated in the figure below.~~

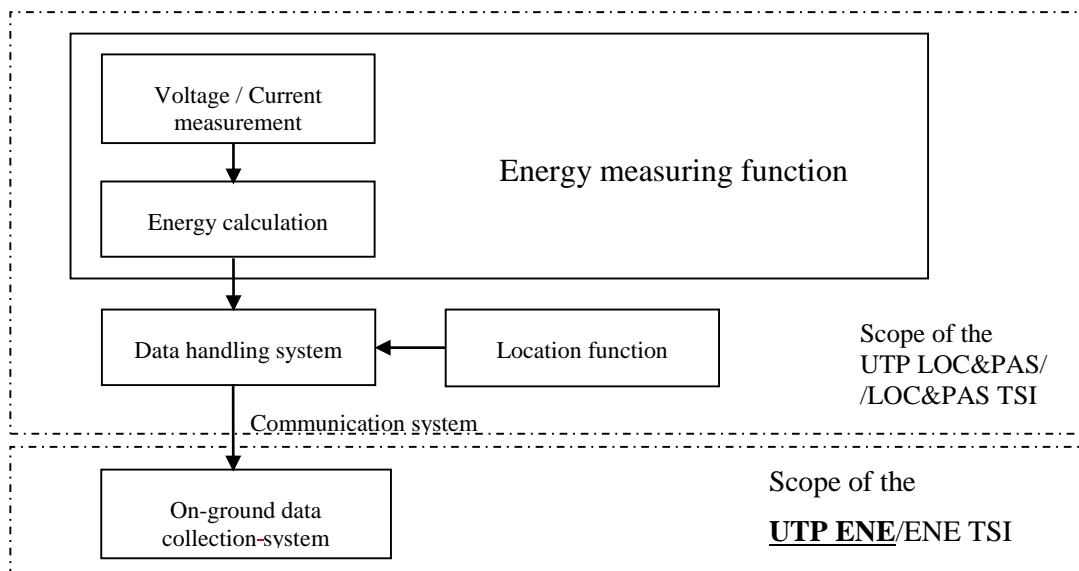

Figure D-1

The EMS shall measure energy supplied by the power supply systems for which the traction unit is designed and shall fulfill the following requirements:



- ~~— all active and reactive energy taken from and returned to the OCL is measured;~~
- ~~— the EMS rated current and voltage shall be matched to the traction unit rated current and voltage;~~
- ~~— it shall continue to function correctly when changing between traction energy supply systems;~~
- ~~— the EMS shall be protected from non authorised access;~~
- ~~— loss of the power supply to the EMS shall not affect data stored in the EMS.~~

~~It is permissible to access the data in the EMS for other purposes (e.g. feedback to the driver in connection with the efficient operation of the train) provided that it can be demonstrated that the integrity of EMS functions and data are not compromised by this arrangement.~~

2. Energy measuring function (EMF)

2.1. Metrological requirements

~~EMF is subject to metrological control, which shall be executed in accordance with the following:~~

- ~~(1) Accuracy of EMF for active energy measurement shall comply with clauses 4.2.4.1 to 4.2.4.4 of the specification referenced in Annex J-1, index 103~~
- ~~(1) Each device containing one or more functions of EMF shall indicate:
 - ~~(a) metrological control, and~~
 - ~~(b) its accuracy class, according to the class designations specified in the specification referenced in Annex J-1, index 103.~~~~
- ~~— The accuracy class shall be verified by testing.~~

2.2. Other requirements

~~The measured energy values produced by EMF shall have a time reference period of 5 minutes defined by the UTC clock time at the end of each time reference period; originating from the time stamp 00:00:00.~~

~~It is permitted to use a shorter measuring period if the data can be aggregated on-board into 5 minutes time reference period.~~

3. Data handling system (DHS)

~~The DHS shall compile the data without corrupting them.~~

~~The DHS shall use, as a time reference, the same source of clock as in the EMF.~~

~~The DHS shall incorporate data storage with a memory capacity sufficient to store the compiled data of at least 60 days continuous work.~~

~~The DHS shall have a capability to be interrogated locally by authorised personnel on board the train using appropriate equipment (e.g. laptop computer) in order to provide an opportunity for audit, and an alternative method of recovering data.~~

 OTIF	Uniform Technical Prescription (UTP)		UTP LOC&PAS	
	LOCOMOTIVES AND PASSENGER ROLLING STOCK		Page 236 of 272	
Status: DRAFT	Version: 03	TECH-20041 Annex	Original: EN	Date: 20.10.2020

~~The DHS shall produce CEED (compiled energy billing data sets) by merging the following data for each time reference period:~~

- ~~— unique EMS identification number, consisting of the European vehicle number (EVN) followed by one additional digit uniquely identifying each EMS on board the traction unit, and no dividers included;~~
- ~~— end time of each period, defined as year, month, day, hour, minute and second;~~
- ~~— the location data at the end of each period;~~
- ~~— consumed/regenerated active and reactive (if appropriate) energy in each period, in units of Watt hour (active energy) and var hour (reactive energy) or their decimal multiples.~~

4. Location function

~~The location function shall provide location data to the DHS which originates from an external source.~~

~~The data from the location function shall be synchronised in accordance with UTC clock time and time reference period with the on-board EMF.~~

~~The location function shall provide the position expressed in latitude and longitude using decimal degrees with five decimal places. Positive values shall be used for North and East; negative values shall be used for South and West.~~

~~In open air the location function shall have an accuracy of 250 m or less.~~

5. On-board to ground communication

~~The specification related to interface protocols and transferred data format are an open point.~~

6. Particular assessment procedures

6.1. Energy measurement system

~~Where assessment methods set out in the standard series referenced in Annex J-1, index 103, 104 and 105 are referenced below, only those aspects necessary for the assessment of the requirements above in this Appendix D shall be undertaken in relation to the EMS which is a part of the~~

~~UTP verification~~

~~EC verification~~

~~activity for the rolling stock subsystem.~~

6.1.1. EMF

~~The accuracy of the each device containing one or more functions of EMF shall be assessed by testing each function, under reference conditions, using the relevant method as described in clause 5.4.3.4.1, 5.4.3.4.2 and 5.4.4.3.1 of the specification referenced in Annex J-1, index 103. The input quantity and power factor range when testing shall correspond to the values set out in Table 3 of the specification referenced in Annex J-1, index 103.~~

 OTIF	Uniform Technical Prescription (UTP)		UTP LOC&PAS	
	LOCOMOTIVES AND PASSENGER ROLLING STOCK		Page 237 of 272	
Status: DRAFT	Version: 03	TECH-20041 Annex	Original: EN	Date: 20.10.2020

~~The accuracy of the complete EMF shall be assessed by calculation, using the method described in clause 4.2.4.2 of the specification referenced in Annex J-1, index 103.~~

~~The effects of temperature on accuracy of the each device containing one or more functions of EMF shall be assessed by testing each function, under reference conditions (except for temperature), using the relevant method as described in clause 5.4.3.4.3.1, and 5.4.4.3.2.1 of the specification referenced in Annex J-1, index 103.~~

~~The mean temperature coefficient of each device containing one or more functions of EMF shall be assessed by testing each function, under reference conditions (except for temperature), using the relevant method as described in clause 5.4.3.4.3.2 and 5.4.4.3.2.2 of the specification referenced in Annex J-1, index 103.~~

6.1.2 DHS

~~The compiling and handling of data within the DHS shall be assessed by testing using the method as described in clause 5.4.8.3.1, 5.4.8.5.1, 5.4.8.5.2 and 5.4.8.6 of the specification referenced in Annex J-1, index 104.~~

6.1.3 EMS

~~The correct functioning of the EMS shall be assessed by testing using the method as described in clause 5.3.2.2, 5.3.2.3, 5.3.2.4 and 5.5.3.2 of the specification referenced in Annex J-1, index 105.~~

 OTIF	Uniform Technical Prescription (UTP)		UTP LOC&PAS	
	LOCOMOTIVES AND PASSENGER ROLLING STOCK		Page 238 of 272	
Status: DRAFT	Version: 03	TECH-20041 Annex	Original: EN	Date: 20.10.2020

APPENDIX D
REFERENCE WAGON FOR LOCOMOTIVES FITTED WITH AUTOMATIC END CENTRE BUFFER COUPLERS AND CAPABLE OF A TRACTION EFFORT AT COUPLING HIGHER THAN 300 kN⁵⁶

For collisions between a train unit and a wagon fitted both with heavy duty couplers, the wagon shall be represented by a mass of 80 t which has only one degree of freedom in the translational x direction. The wagon interface geometry is shown in Figure D.1. The end wall and coupler head geometry shall be assumed to be rigid. It shall be equipped with a centre coupler with a stroke of 110 mm and the force-displacement characteristic indicated in Figure D.2. The total energy absorption capacity of the wagon coupler is 77 kJ.

The coupler head geometry and height above top of rail shall be the same as that of the impacting train unit. The longitudinal distance of the coupler plane to the end wall of the wagon shall be 645 mm. For simplification it is allowed to model the coupler heads using the geometry and height given in Figure D.1.

Dimensions in millimetres

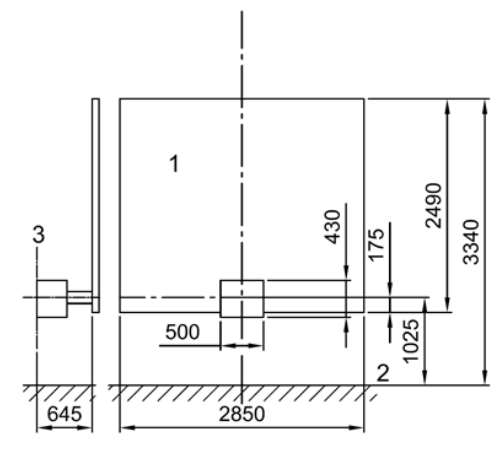

Key

1 wagon end

2 top of rail

3 coupler plane

Figure D.1 — Wagon interface with centre coupler

⁵⁶- [Regulation \(EU\) 2020/387 of 9 March 2020](#)

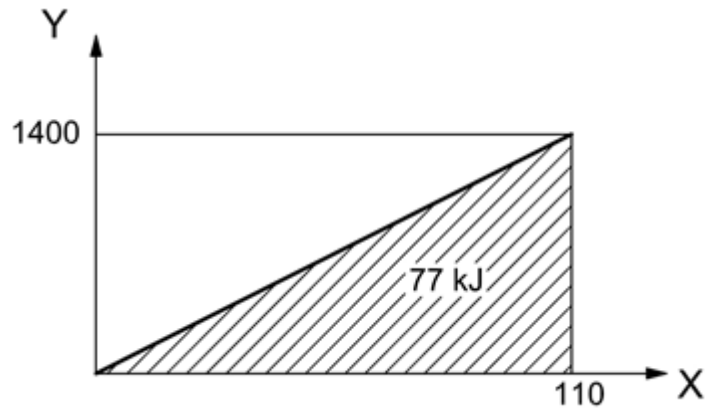

Key

Ycoupler force - coupler, in kN

Xdisplacement, in mm

Figure D.2 — Wagon coupler characteristic

 OTIF	Uniform Technical Prescription (UTP)		UTP LOC&PAS	
	LOCOMOTIVES AND PASSENGER ROLLING STOCK		Page 240 of 272	
Status: DRAFT	Version: 03	TECH-20041 Annex	Original: EN	Date: 20.10.2020

APPENDIX E ANTHROPOMETRIC MEASUREMENTS OF THE DRIVER

The following data represents the “state of the art” and shall be used.

Note: they will be subject of an EN standard currently under drafting process.

- Principal anthropometric measurements of the shortest and tallest driving staff:
The dimensions given in Appendix E of the UIC 651 (4th edition, July 2002) shall be taken into consideration.
- Additional anthropometric dimensions of the shortest and tallest driving staff:
The dimensions given in Appendix G of the UIC 651 (4th edition, July 2002) shall be taken into consideration.

 OTIF	Uniform Technical Prescription (UTP)		UTP LOC&PAS	
	LOCOMOTIVES AND PASSENGER ROLLING STOCK		Page 241 of 272	
Status: DRAFT	Version: 03	TECH-20041 Annex	Original: EN	Date: 20.10.2020

APPENDIX F FRONT VISIBILITY

The following data represents the “state of the art” and shall be used.

Note: they will be subject of an EN standard currently under drafting process.

F.1. General

The design of the cab shall support the drivers’ view of all external information that form part of the driving task as well as protecting the driver from external sources of visual interference. This shall include the following:

- Flicker at the lower edge of the windscreen, which can cause fatigue, shall be reduced
- Protection shall be provided from the sun and glare of headlights from oncoming trains, without reducing the drivers’ view of external signs, signals and other visual information
- Location of cab equipment shall not block or distort the drivers view of external information
- The dimension, location, shape and finishes (including maintenance) of the windows shall not inhibit the drivers external view and shall support the driving task
- The location, type and quality of windscreen cleaning and clearance devices shall ensure that the driver is able to maintain a clear external view in most weather and operating conditions, and shall not inhibit the drivers external view.
- The driver’s cab shall be designed in such a way that the driver is facing forwards when driving.
- The driver’s cab shall be designed to allow the driver at his seated driving position a clear and unobstructed line of sight in order to distinguish fixed signals set to both the left and right of the track, as defined in Appendix D of the UIC 651(4th edition, July 2002).

Note: the position of the seat in the Appendix D mentioned here above has to be considered as an example; the

UTP

~~TSI~~

does not impose the position of the seat (left, central or right) in the cab; the

UTP

~~TSI~~

does not impose the standing driving position on all types of units.

The rules expressed in the Appendix above govern the conditions of visibility for each running direction along straight track and in curves with a radius of 300 m and more. They apply to the position(s) of the driver.

Notes:

- in case of cab fitted with 2 driver’s seats (option with 2 driving positions), they apply to the 2 seated positions.

 OTIF	Uniform Technical Prescription (UTP)		UTP LOC&PAS	
	LOCOMOTIVES AND PASSENGER ROLLING STOCK		Page 242 of 272	
Status: DRAFT	Version: 03	TECH-20041 Annex	Original: EN	Date: 20.10.2020

– for locomotives with central cab and for OTMs, the clause 4.2.9.1.3.1 of the

UTP

~~TSI~~

specify particular conditions.

F.2. Reference position of vehicle in relation to track:

The clause 3.2.1 of the UIC 651 (4th edition, July 2002) shall apply.

The supplies and payload shall be considered as defined in the specification referenced in Annex J-1, index 13 and clause 4.2.2.10 of this

UTP.

~~TSI~~

F.3. Reference position for the eyes of crew members

The clause 3.2.2 of the UIC 651 (4th edition, July 2002) shall apply.

The distance from the driver's eyes in seating posture to the windscreen shall be higher than or equal to 500 mm.

F.4. Conditions of visibility

The clause 3.3 of the UIC 651 (4th edition, July 2002) shall apply.

Note: the clause 3.3.1 of the UIC 651 refers for the standing position to its clause 2.7.2, specifying a minimum distance of 1.8 meters between floor and top edge of the front window.



APPENDIX G SERVICING

Connections for the toilet discharge system on rolling stock

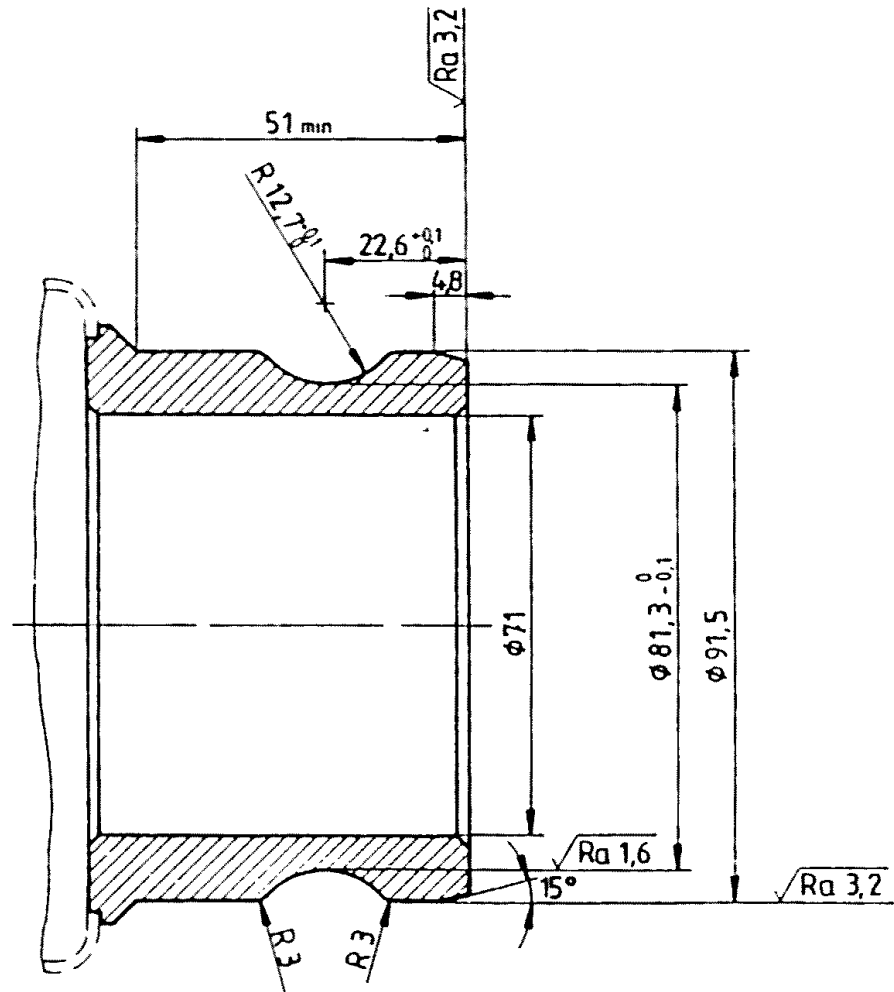

General tolerances +/- 0,1

Material: stainless steel

Fig. G1 Evacuation nozzle (Inner part)

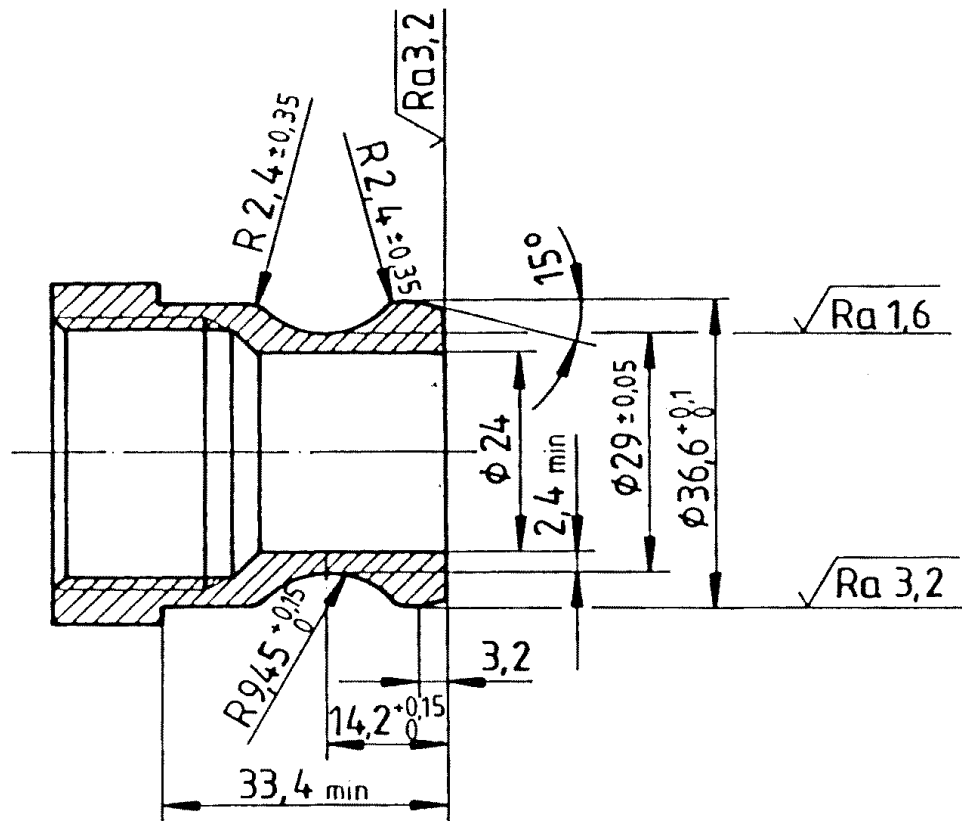

General tolerances +/- 0,1

Material: stainless steel

Fig. G2 Optional flushing connection for the toilet tank (Inner part)

 OTIF	Uniform Technical Prescription (UTP)		UTP LOC&PAS	
	LOCOMOTIVES AND PASSENGER ROLLING STOCK		Page 245 of 272	
Status: DRAFT	Version: 03	TECH-20041 Annex	Original: EN	Date: 20.10.2020

APPENDIX H ASSESSMENT OF THE ROLLING STOCK SUBSYSTEM

H.1 Scope

This Appendix indicates the assessment of conformity of the rolling stock subsystem.

H.2 Characteristics and modules

The sub-system characteristics to be assessed in the different phases of design, development and production are marked by X in Table H.1. A cross in column 4 of Table H.1 indicates that the relevant characteristics shall be verified by testing each single subsystem.

Table H.1 – Assessment of the rolling stock subsystem

1		2	3	4	5
Characteristics to be assessed, as specified in clause 4.2 of this UTP/ TSI		Design and development phase		Production phase	Particular assessment procedure
		Design review	Type Test	Routine Test	
<i>Element of the Rolling Stock sub-system</i>	<i>Clause</i>				<i>Clause</i>
Structure and mechanical parts	4.2.2				
Inner coupling	4.2.2.2.2	X	n.a.	n.a.	-
End coupling	4.2.2.2.3	X	n.a.	n.a.	-
IC automatic centre buffer coupler	5.3.1	X	X	X	-
IC manual end coupling	5.3.2	X	X	X	-
Rescue coupling	4.2.2.2.4	X	X	n.a.	-
IC rescue coupling	5.3.3	X	X	X	
Staff access for coupling and uncoupling	4.2.2.2.5	X	X	n.a.	-
Gangways	4.2.2.3	X	X	n.a.	-
Strength of vehicle structure	4.2.2.4	X	X	n.a.	-
Passive safety	4.2.2.5	X	X	n.a.	-
Lifting and jacking	4.2.2.6	X	X	n.a.	-
Fixing of devices to carbody structure	4.2.2.7	X	n.a.	n.a.	-
Staff and freight access doors	4.2.2.8	X	X	n.a.	-



1		2	3	4	5
Characteristics to be assessed, as specified in clause 4.2 of this UTP/TSI		Design and development phase		Production phase	Particular assessment procedure
		Design review	Type Test	Routine Test	
<i>Element of the Rolling Stock sub-system</i>	<i>Clause</i>				<i>Clause</i>
Mechanical characteristics of glass	4.2.2.9	X	n.a.	n.a.	-
Load conditions and weighted mass	4.2.2.10	X	X	X	6.2.3.1
Track interaction and gauging	4.2.3				
Gauging	4.2.3.1	X	n.a.	n.a.	-
Wheel load	4.2.3.2.2	X	X	n.a.	6.2.3.2
Rolling Stock characteristics for compatibility with train detection systems	4.2.3.3.1	X	X	X	-
Axle bearing condition monitoring	4.2.3.3.2	X	X	n.a.	-
Safety against derailment running on twisted track	4.2.3.4.1	X	X	n.a.	6.2.3.3
Running dynamic behaviour requirements	4.2.3.4.2 a)	X	X	n.a.	6.2.3.4
Active systems – safety requirement	4.2.3.4.2 b)	X	n.a.	n.a.	6.2.3.5
Limit values for running safety	4.2.3.4.2.1	X	X	n.a.	6.2.3.4
Track loading limit values	4.2.3.4.2.2	X	X	n.a.	6.2.3.4
Equivalent conicity	4.2.3.4.3	X	n.a.	n.a.	-
Design values for new wheel profiles	4.2.3.4.3.1	X	n.a.	n.a.	6.2.3.6
In-service values of wheelset equivalent conicity	4.2.3.4.3.2	X			-
Structural design of bogie frame	4.2.3.5.1	X	X	n.a.	-
Mechanical and geometrical characteristics of wheelsets	4.2.3.5.2.1	X	X	X	6.2.3.7
Mechanical and geometrical characteristics of wheels	4.2.3.5.2.2	X	X	X	-
Wheels (IC)	5.3.2	X	X	X	6.1.3.1
Automatic variable gauge wheelsets systems	4.2.3.5.2.3	X open	X open	X open	6.2.3.7a Open
Automatic variable gauge systems (IC)	5.3.4a	X	X	X	6.1.3.1a
Minimum curve radius	4.2.3.6	X	n.a.	n.a.	-
Life guards	4.2.3.7	X	n.a.	n.a.	-



1		2	3	4	5
Characteristics to be assessed, as specified in clause 4.2 of this UTP/TSI		Design and development phase		Production phase	Particular assessment procedure
		Design review	Type Test	Routine Test	
<i>Element of the Rolling Stock sub-system</i>	<i>Clause</i>				<i>Clause</i>
Braking	4.2.4				
Functional requirements	4.2.4.2.1	X	X	n.a	-
Safety requirements	4.2.4.2.2	X	n.a	n.a	6.2.3.5
Type of brake system	4.2.4.3	X	X	n.a	-
Brake command	4.2.4.4				
Emergency braking	4.2.4.4.1	X	X	X	-
Service braking	4.2.4.4.2	X	X	X	-
Direct braking command	4.2.4.4.3	X	X	X	-
Dynamic braking command	4.2.4.4.4	X	X	n.a	-
Parking braking command	4.2.4.4.5	X	X	X	-
Braking performance	4.2.4.5				
General requirements	4.2.4.5.1	X	n.a	n.a	-
Emergency braking	4.2.4.5.2	X	X	X	6.2.3.8
Service braking	4.2.4.5.3	X	X	X	6.2.3.9
Calculations related to thermal capacity	4.2.4.5.4	X	n.a	n.a	-
Parking brake	4.2.4.5.5	X	n.a	n.a	-
Limit of wheel rail adhesion profile	4.2.4.6.1	X	n.a	n.a	-
Wheel slide protection system	4.2.4.6.2	X	X	n.a	6.2.3.10
Wheel slide protection system (IC)	5.3.53	X	X	X	6.1.3.2
Interface with traction - Braking systems linked to traction (electric, hydro-dynamic)	4.2.4.7	X	X	X	-
Braking system independent of adhesion conditions	4.2.4.8				
General	4.2.4.8.1	X	n.a	n.a	-
Magnetic track brake	4.2.4.8.2	X	X	n.a	-
Eddy current track brake	4.2.4.8.3	X open	X Open	n.a Open	Open
Brake state and fault indication	4.2.4.9	X	X	X	-
Brake requirements for rescue purposes	4.2.4.10	X	X	n.a	-
Passenger related items	4.2.5				



1		2	3	4	5
Characteristics to be assessed, as specified in clause 4.2 of this UTP/ TSI		Design and development phase		Production phase	Particular assessment procedure
		Design review	Type Test	Routine Test	
<i>Element of the Rolling Stock sub-system</i>	<i>Clause</i>				<i>Clause</i>
Sanitary systems	4.2.5.1	X	n.a	n.a	6.2.3.11
Public address system: a Audible communication system	4.2.5.2	X	X	X	-
Passenger alarm	4.2.5.3	X	X	X	-
Passenger alarm – safety requir.	4.2.5.3	X	n.a	n.a	6.2.3.5
Communication devices for passengers	4.2.5.4	X	X	X	-
Exterior doors: access to and egress from Rolling Stock	4.2.5.5	X	X	X	-
Exterior doors – safety requir.	4.2.5.5	X	n.a	n.a	6.2.3.5
Exterior door system construction	4.2.5.6	X	n.a	n.a	-
inter-unit doors	4.2.5.7	X	X	n.a	-
Internal air quality	4.2.5.8	X	n.a	n.a	6.2.3.12
Body side windows	4.2.5.9	X			-
Environmental conditions and aerodynamic effects	4.2.6				
Environmental conditions	4.2.6.1				
Temperature	4.2.6.1.1	X	n.a. X ⁽¹⁾	n.a.	-
Snow, ice and hail	4.2.6.1.2	X	n.a. X ⁽¹⁾	n.a.	-
⁽¹⁾ Type test if and as defined by the Applicant.					
Aerodynamic effects	4.2.6.2				
Slipstream effects on passengers on platform and on workers trackside	4.2.6.2.1	X	X	n.a.	6.2.3.13
Head pressure pulse	4.2.6.2.2	X	X	n.a.	6.2.3.14
Maximum pressure variations in tunnels	4.2.6.2.3	X	X	n.a.	6.2.3.15
Cross wind	4.2.6.2.4	X	n.a	n.a.	6.2.3.16
External lights & visible and audible warning devices	4.2.7				
External front and rear lights	4.2.7.1				
Head lights IC	4.2.7.1.1 5.3.6	X	X	n.a	- 6.1.3.3



1		2	3	4	5
Characteristics to be assessed, as specified in clause 4.2 of this UTP/TSI		Design and development phase		Production phase	Particular assessment procedure
		Design review	Type Test	Routine Test	
<i>Element of the Rolling Stock sub-system</i>	<i>Clause</i>				<i>Clause</i>
Marker lights IC	4.2.7.1.2 5.3.7	X	X	n.a	- 6.1.3.4
Tail lights IC	4.2.7.1.3 5.3.8	X	X	n.a	- 6.1.3.5
Lamp controls	4.2.7.1.4	X	X	n.a	-
Horn	4.2.7.2				
General – warning sound IC	4.2.7.2.1 5.3.9	X	X	n.a	- 6.1.3.6
Warning horn sound pressure levels	4.2.7.2.2 5.3.9	X	X	n.a	6.2.3.17 6.1.3.6
Protection	4.2.7.2.3	X	n.a	n.a	-
Control	4.2.7.2.4	X	X	n.a	-
Traction and electrical equipment	4.2.8				
Traction performance	4.2.8.1				
General	4.2.8.1.1				
Requirements on performance	4.2.8.1.2	X	n.a	n.a	-
Power supply	4.2.8.2				
General	4.2.8.2.1	X	n.a	n.a	-
Operation within range of voltages and frequencies	4.2.8.2.2	X	X	n.a	-
Regenerative brake with energy to the overhead contact line	4.2.8.2.3	X	X	n.a	-
Maximum power and current from the overhead contact line	4.2.8.2.4	X	X	n.a	6.2.3.18
Maximum current at standstill for DC systems	4.2.8.2.5	X	X	n.a	-
Power factor	4.2.8.2.6	X	X	n.a	6.2.3.19
System energy disturbances	4.2.8.2.7	X	X	n.a	-
Energy consumption measuring function	4.2.8.2.8	X	X	n.a	-
Requirements linked to pantograph	4.2.8.2.9	X	X	n.a	6.2.3.20 & 21
Pantograph (IC)	5.3.10	X	X	X	6.1.3.7



1		2	3	4	5
Characteristics to be assessed, as specified in clause 4.2 of this UTP/ TSI		Design and development phase		Production phase	Particular assessment procedure
		Design review	Type Test	Routine Test	
<i>Element of the Rolling Stock sub-system</i>	<i>Clause</i>				<i>Clause</i>
Contact strips (IC)	5.3.11	X	X	X	6.1.3.8
Electrical protection of the train IC Main circuit breaker	4.2.8.2.10 5.3.12	X	X	n.a	-
Diesel and other thermal traction system	4.2.8.3	-	-	-	Other Directive
Protection against electrical hazards	4.2.8.4	X	X	n.a	-
Cab and operation	4.2.9				
Driver's Cab	4.2.9.1	X	n.a	n.a	-
General	4.2.9.1.1	X	n.a	n.a	-
Access and egress	4.2.9.1.2	X	n.a	n.a	-
Access and egress in operating conditions	4.2.9.1.2.1	X	n.a	n.a	-
Driver's cab emergency exit	4.2.9.1.2.2	X	n.a	n.a	-
External visibility	4.2.9.1.3	X	n.a	n.a	-
Front visibility	4.2.9.1.3.1	X	n.a	n.a	-
Rear and side view	4.2.9.1.3.2	X	n.a	n.a	-
Interior layout	4.2.9.1.4	X	n.a	n.a	-
Driver's seat	4.2.9.1.5	X	n.a	n.a	-
IC	5.3.13	X	X	X	-
Driver's desk – Ergonomics	4.2.9.1.6	X	n.a	n.a	-
Climate control and air quality	4.2.9.1.7	X	X	n.a	6.2.3.12
Internal lighting	4.2.9.1.8	X	X	n.a	-
Windscreen – Mechanical characteristics	4.2.9.2.1	X	X	n.a	6.2.3.22
Windscreen-Optical characteristics	4.2.9.2.2	X	X	n.a	6.2.3.22
Windscreen-Equipment	4.2.9.2.3	X	X	n.a	-
Driver machine interface	4.2.9.3				
Driver's activity control function	4.2.9.3.1	X	X	X	-
Speed indication	4.2.9.3.2	-	-	-	-
Driver display unit and screens	4.2.9.3.3	X	X	n.a	-
Controls and indicators	4.2.9.3.4	X	X	n.a	-



1		2	3	4	5
Characteristics to be assessed, as specified in clause 4.2 of this UTP/ TSI		Design and development phase		Production phase	Particular assessment procedure
		Design review	Type Test	Routine Test	
<i>Element of the Rolling Stock sub-system</i>	<i>Clause</i>				<i>Clause</i>
Labelling	4.2.9.3.5	X	n.a	n.a	-
Radio remote control function by staff for shunting operation	4.2.9.3.6	X	X	n.a	-
Onboard tools and portable equipment	4.2.9.4	X	n.a	n.a	-
Storage facility for staff personal effects	4.2.9.5	X	n.a	n.a	-
Recording device	4.2.9.6	X	X	X	-
Fire safety and evacuation	4.2.10				
General and categorisation	4.2.10.1	X	n.a	n.a	-
Measures to prevent fire	4.2.10.2	X	X	n.a	-
Measures to detect/control fire	4.2.10.3	X	X	n.a	-
Requirements related to emergencies	4.2.10.4	X	X	n.a	-
Requirements related to evacuation	4.2.10.5	X	X	n.a	-
Servicing	4.2.11				
Cleaning of driver's cab windscreen	4.2.11.2	X	X	n.a	-
Connection to toilet discharge system IC	4.2.11.3 5.3.14	X	n.a	n.a	-
Water refilling equipment	4.2.11.4	X	n.a	n.a	-
Interface for water refilling IC	4.2.11.5 5.3.15	X	n.a	n.a	-
Special requirements for stabling of trains	4.2.11.6	X	X	n.a	-
Refuelling equipment	4.2.11.7	X	n.a	n.a	-
Train interior cleaning – power supply	4.2.11.8	X	n.a	n.a	-
Documentation for operation and maintenance	4.2.12				
General	4.2.12.1	X	n.a	n.a	-
General documentation	4.2.12.2	X	n.a	n.a	-
Documentation related to maintenance	4.2.12.3	X	n.a	n.a	-
The maintenance design justification file	4.2.12.3.1	X	n.a	n.a	-
The Maintenance description file	4.2.12.3.2	X	n.a	n.a	-



1		2	3	4	5
Characteristics to be assessed, as specified in clause 4.2 of this UTP/ TSI		Design and development phase		Production phase	Particular assessment procedure
		Design review	Type Test	Routine Test	
<i>Element of the Rolling Stock sub-system</i>	<i>Clause</i>				<i>Clause</i>
Operating documentation	4.2.12.4	X	n.a	n.a	-
Lifting diagram and instructions	4.2.12.4	X	n.a	n.a	-
Rescue related descriptions	4.2.12.5	X	n.a	n.a	-

 OTIF	Uniform Technical Prescription (UTP)		UTP LOC&PAS	
	LOCOMOTIVES AND PASSENGER ROLLING STOCK		Page 253 of 272	
Status: DRAFT	Version: 03	TECH-20041 Annex	Original: EN	Date: 20.10.2020

APPENDIX I ASPECTS FOR WHICH THE TECHNICAL SPECIFICATION IS NOT AVAILABLE (OPEN POINTS)

Open points that relate to technical compatibility between the vehicle and the network:

Element of the Rolling Stock sub-system	Clause of this UTP/TSI	Technical aspect not covered by this UTP/TSI	Comments
Compatibility with train detection systems	4.2.3.3.1	See specification referenced in Annex J-2, index 1.	Open points also identified in the TSI CCS.
Running dynamic behaviour for 1520 mm track gauge system	4.2.3.4.2 4.2.3.4.3	Running dynamic behaviour. Equivalent conicity.	Normative documents referred to in the UTP/TSI are based on experience gained on the 1435 mm system.
Braking system independent of adhesion conditions	4.2.4.8.3	Eddy current track brake	Equipment not mandatory. Electromagnetic compatibility with concerned network to be checked.
Aerodynamic effects for 1520 mm, 1524 mm and 1668 mm track gauge systems	4.2.6.2	Limit values and conformity assessment	Normative documents referred to in the UTP/TSI are based on experience gained on the 1435 mm system.
Aerodynamic effect on ballasted track for RST of design speed \geq 250 190 km/h	4.2.6.2.5	Limit value and conformity assessment in order to limit risks induced by the projection of ballast	On-going work within CEN. Open point also in TSI INF.

Open points that do not relate to technical compatibility between the vehicle and the network:

Element of the Rolling Stock sub-system	Clause of this UTP/TSI	Technical aspect not covered by this UTP/TSI	Comments
Passive Safety	4.2.2.5	Application of scenarios 1 and 2 to locomotives with centre couplers and traction effort higher than 300 kN.	If no technical solution available, possible restrictions at the level of operation.
Variable gauge wheelsets	4.2.3.5.2.3	Conformity assessment	Design option.
On-board energy measurement system	4.2.8.2.8 & Appendix D	On-board to ground communication: specification related to interface protocols and transferred data format.	Description of on-board to ground communication shall be provided in the technical documentation. The standard series EN 61375-2-6 should be used.
Fire Containment and Control Systems	4.2.10.3.4	Conformity assessment of FCCS other than full partitions.	Assessment procedure of efficiency for controlling fire and smoke developed by CEN according to a request for standard issued by ERA.

 OTIF	Uniform Technical Prescription (UTP)		UTP LOC&PAS	
	LOCOMOTIVES AND PASSENGER ROLLING STOCK		Page 254 of 272	
Status: DRAFT	Version: 03	TECH-20041 Annex	Original: EN	Date: 20.10.2020

APPENDIX J
TECHNICAL SPECIFICATIONS REFERRED TO IN THIS UTP/TSI

J.1. Standards or normative documents

Index N°	UTP/TSI		Normative document	
	Characteristics to be assessed	Point	Document N°	Mandatory points
1	Inner coupling for articulated units	4.2.2.2.2	EN 12663-1:2010 + A1:2014	6.5.3, 6.7.5
2	End coupling – manual UIC type – pipes interface	4.2.2.2.3	EN 15807:2012 1	relevant cl. ⁶
3	End coupling – manual UIC type – end cocks	4.2.2.2.3	EN 14601:2005 + A1:2010	relevant cl. ⁶
4	End coupling – manual UIC type – lateral location of brake pipe and cocks	4.2.2.2.3	UIC 648:Sept 2001	relevant cl. ⁶
5	Rescue coupling – interface with recovery unit	4.2.2.2.4	UIC 648:Sept 2001	relevant cl. ⁶
6	Staff access for coupling and uncoupling – space for shunting staff	4.2.2.2.5	EN 16839 164 :2013 7	46.2
7	Strength of vehicle structure – general categorisation of rolling stock method of verification	4.2.2.4 Appendix C	EN 12663-1:2010 + A1:2014	relevant cl. ⁶ 5.2 9.2 6.1 – 6.5
	Strength of vehicle structure – categorisation of rolling stock			5.2
	Strength of vehicle structure – method of verification			9.2
	Strength of vehicle structure – alternative requirements for OTMs	Appendix C Section C.1	6.1 to 6.5	
8	Passive safety – general categorisation scenarios obstacle deflector	4.2.2.5	EN 15227:2017 08 +A1:2011 EN 15227:2008+A1:2010	relevant cl. ⁶ Except Annex A 4 – table 1 5 – table 2, 6 5 – table 3, 6.5
	Passive safety – categorisation		4 – table 1	
	Passive safety – scenarios		5 – table 2, 6	



Index N°	UTP/ TSI		Normative document	
	Characteristics to be assessed	Point	Document N°	Mandatory points
	Passive safety – obstacle deflector			6.5
9	Lifting and jacking – geometry of permanent and removable points	4.2.2.6	EN 16404:2016 4	5.2 , 5.3 , 5.4
10	Lifting and jacking – marking	4.2.2.6	EN 15877-2:2013	4.5. 17 19
11	Lifting and jacking – strength method of verification	4.2.2.6	EN 12663-1:2010 + A1:2014	6.3.2, 6.3.3, 9.2
12	Fixing of devices to carbody structure	4.2.2.7	EN 12663-1:2010 + A1:2014	6.5.2
13	Load conditions and weighed mass – load conditions hypothesis of load conditions	4.2.2.10	EN 15663:2009 /AC:2010	2.1 relevant cl. ⁶
14	Gauging – method, reference contours verification of pantograph gauge	4.2.3.1	EN 15273-2:2013 + A1:2016	relevant cl. ⁶ A.3.12
	Gauging – method, reference contours verification of eddy current track brakes verification of pantograph gauge	4.2.4.8.3(3)		A.3.12
	Gauging – method, reference contours verification of eddy current track brakes verification of pantograph gauge	4.2.3.1		relevant cl.⁶
15	Axle bearing condition monitoring – zone visible to track side equipment	4.2.3.3.2.2	EN 15437-1:2009	5.1, 5.2
16	Running dynamic behaviour	4.2.3.4.2 Appendix C	EN 14363:2016 05	relevant cl. ⁶
17	Running dynamic behaviour – limit values for running safety	4.2.3.4.2.1	EN 14363:2016 05	5.3.2.2 7.5
18	NOT USED			
18	Running dynamic behaviour – for rolling stock with a cant deficiency > 165 mm	4.2.3.4.2.1	EN 15686:2010	relevant cl.⁶
19	Running dynamic behaviour – track loading limit values	4.2.3.4.2.2	EN 14363:2016 05	5.3.2.3 7.5
20	Structural design of the bogie frame	4.2.3.5.1	EN 13749:2011	6.2, Annex C
21	Structural design of the bogie frame – body to bogie connection	4.2.3.5.1	EN 12663-1:2010 + A1:2014	relevant cl. ⁶



Index N°	UTP/ TSI		Normative document	
	Characteristics to be assessed	Point	Document N°	Mandatory points
22	Braking – type of brake system, UIC brake system	4.2.4.3 6.2.7a	EN 14198:2016 04	5.4
23	Braking performance – calculation – general	4.2.4.5.1	EN 14531-1:2005 or EN 14531-6:2009	relevant cl. ⁶
24	Braking performance – friction coefficient	4.2.4.5.1	EN 14531-1:2005	5.3.1.4
25	Emergency braking performance – response time / delay time brake weight percentage	4.2.4.5.2	EN 14531-1:2005	5.3.3
	Emergency braking performance – brake weight percentage			5.12
26	Emergency braking performance – calculation	4.2.4.5.2	EN 14531-1:2005 or EN 14531-6:2009	relevant cl. ⁶
27	Emergency braking performance – friction coefficient	4.2.4.5.2	EN 14531-1:2005	5.3.1.4
28	Service braking performance – calculation	4.2.4.5.3	EN 14531-1:2005 or EN 14531-6:2009	relevant cl. ⁶
29	Parking brake performance – calculation	4.2.4.5.5	EN 14531-1:2005 or EN 14531-6:2009	relevant cl. ⁶
30	Wheel slide protection system – design verification method wheel rotation monitoring system	4.2.4.6.2	EN 15595:2009 + A1:2011	4
	Wheel slide protection system – verification method			5,6 4.2.4.3
	Wheel slide protection system – wheel rotation monitoring system			5,6 4.2.4.3
31	Magnetic track brake	4.2.4.8.2	EN 16207:2014 UIC 541-06:Jan-1992	Annex C ppendix 3
32	Door obstacle detection – sensitivity maximum force	4.2.5.5.3	Fpr EN 14752:2014 5	5.2.1.4.1
	Door obstacle detection – maximum force			5.2.1.4.2.2 5.2.1.4.2.2
33	Door emergency opening – manual force to open the door	4.2.5.5.9	Fpr EN 14752:2014 54	5.5.1.5
34	Environmental conditions – temperature	4.2.6.1.1	EN 50125-1: 2014 1999	4.3



Index N°	UTP/ TSI		Normative document	
	Characteristics to be assessed	Point	Document N°	Mandatory points
35	Environmental conditions – snow, ice and hail conditions	4.2.6.1.2	EN 50125-1: 2014 1999	4.7
36	Environmental conditions – obstacle deflector	4.2.6.1.2	EN 15227:2008 +A1: 2011 2010	relevant cl. ⁶
37	Aerodynamic effects – crosswind method of verification	4.2.6. 2 .4	EN 14067-6:2010	5
38	Head lights – colour dimmed headlamp luminous intensity	4.2.7.1.1	EN 15153-1:2013 + A1:2016	5.3.4
	full-beam headlamp luminous intensity alignment			5.3. 3 5 -table 2 first line
	<u>Head lights – dimmed headlamp luminous intensity</u>			5.3.5-table 2 first line
	<u>Head lights – full-beam headlamp luminous intensity</u>			<u>5.3.4 table 2 first line</u>
	<u>Head lights – alignment</u>			<u>5.3.5</u>
39	Marker lights – colour spectral radiation distribution luminous intensity	4.2.7.1.2	EN 15153-1:2013 + A1:2016	5.4. 3 4 .1 table 4
	<u>Marker lights – spectral radiation distribution</u>			5.4.4.2 5.4.5 table 6
	<u>Marker lights – luminous intensity</u>			<u>5.4.3.2</u>
				<u>5.4.4 table 6</u>
40	Tail lights – colour luminous intensity	4.2.7.1.3	EN 15153-1:2013 + A1:2016	5.5. 3 4 table 7
	<u>Tail lights – luminous intensity</u>			5.5.5 table 8
				<u>5.5.4 table 8</u>
41	Warning horn sound pressure levels	4.2.7.2.2	EN 15153-2:2013	5.2.2
42	Regenerative brake with energy to the overhead contact line	4.2.8.2.3	EN 50388:2012 and EN <u>50388:2012/AC:2013</u>	12.1.1
43	Maximum power and current from the overhead contact line – automatic regulation of current	4.2.8.2.4	EN 50388:2012 and EN <u>50388:2012/AC:2013</u>	7.2
44	Power factor – verification method	4.2.8.2.6	EN 50388:2012 and EN <u>50388:2012/AC:2013</u>	6



Index N°	UTP/ TSI		Normative document	
	Characteristics to be assessed	Point	Document N°	Mandatory points
45	System energy disturbances for AC systems – harmonics and dynamic effects compatibility study	4.2.8.2.7	EN 50388:2012 <u>and EN 50388:2012/AC:2013</u>	10.1 10.3 Table 5 Annex D 10.4
	<u>System energy disturbances for AC systems – compatibility study</u>			<u>10.3</u> <u>Table 5</u> <u>Annex D</u> <u>10.4</u>
46	Working range in height of pantograph (IC level) – characteristics	4.2.8.2.9.1.2	EN 50206-1:2010	4.2, 6.2.3
47	Pantograph head geometry	4.2.8.2.9.2	EN 50367:2012 <u>and EN 50367:2012/AC:2013</u>	5.3.2.2
48	Pantograph head geometry – type 1600 mm	4.2.8.2.9.2.1	EN 50367:2012 <u>and EN 50367:2012/AC:2013</u>	Annex A.2 Figure A.6
49	Pantograph head geometry – type 1950 mm	4.2.8.2.9.2.2	EN 50367:2012 <u>and EN 50367:2012/AC:2013</u>	Annex A.2 Figure A.7
50	Pantograph current capacity (IC level)	4.2.8.2.9.3	EN 50206-1:2010	6.13.2
51	Pantograph lowering (RST level) – time to lower the pantograph ADD	4.2.8.2.9.10	EN 50206-1:2010	4.7 4.8
	<u>Pantograph lowering (RST level) – ADD</u>			<u>4.8</u>
52	Pantograph lowering (RST level) – dynamic insulating distance	4.2.8.2.9.10	EN 50119:2009 <u>and EN 50119:2009/A1:2013</u>	Table 2
53	Electrical protection of the train – coordination of protection	4.2.8.2.10	EN 50388:2012 <u>and EN 50388:2012/AC:2013</u>	11
54	Protection against electrical hazard	4.2.8.4	EN 50153:2014 02	relevant cl. ⁶
55	Windscreen – mechanical characteristics	4.2.9.2.1	EN 15152:2007	4.2.7, 4.2.9
56	Windscreen – <u>angle between</u> primary <u>and</u> secondary images optical distorsion haze luminous transmittance chromaticity	4.2.9.2.2	EN 15152:2007	4.2.2 4.2.3 4.2.4 4.2.5 4.2.6
	<u>Windscreen – optical distorsion</u>			<u>4.2.3</u>
	<u>Windscreen – haze</u>			<u>4.2.4</u>



Index N°	UTP/ TSI		Normative document	
	Characteristics to be assessed	Point	Document N°	Mandatory points
	Windscreen – luminous transmittance			4.2.5
	Windscreen – chromaticity			4.2.6
57	Recording device – functional requirements recording performance integrity data integrity safeguard level of protection	4.2.9.6	EN/IEC 62625-1:2013	4.2.1, 4.2.2, 4.2.3, 4.2.4 4.3.1.1.2 4.3.1.3 4.3.1.4 4.3.1.6
	Recording device – recording performance			4.3.1.1.2
	Recording device – integrity			4.3.1.4
	Recording device – data integrity safeguard			4.3.1.5
	Recording device – level of protection			4.3.1.7
58	Measures to prevent fire – material requirements	4.2.10.2.1	EN 45545-2:2013 + A1:2015	relevant cl. ⁶
59	Specific measures for flammable liquids	4.2.10.2.2	EN 45545-2:2013 + A1:2015	Table 5
60	Fire spreading protection measures for passenger rolling stock – partition test	4.2.10.3.4	EN 1363-1: 2012 1999	relevant cl. ⁶
61	Fire spreading protection measures for passenger rolling stock – partition test	4.2.10.3.5	EN 1363-1: 2012 1999	relevant cl. ⁶
62	Emergency lighting – lighting level	4.2.10.4.1	EN 13272:2012	5.3
63	Running capability	4.2.10.4.4	EN 50553:2012 and EN 50553:2012/AC:2013	relevant cl. ⁶
64	Interface for water filling	4.2.11.5	EN 16362:2013	4.1.2 figure 1
65	Special requirements for stabling of trains – local external auxiliary power supply	4.2.11.6	EN/IEC 60309-2:1999 and amendments EN 60309-2:1999/A11:2004, A1:2007 and A2:2012	relevant cl. ⁶
66	Automatic centre buffer coupler – type 10	5.3.1	EN 16019:2014	relevant cl. ⁶
67	Manual end coupling – UIC type	5.3.2	EN 15551:201 7 09	relevant cl. ⁶
68	Manual end coupling – UIC type	5.3.2	EN 15566:201 6 09	relevant cl. ⁶



Index N°	UTP/ TSI		Normative document	
	Characteristics to be assessed	Point	Document N°	Mandatory points
69	Rescue coupler	5.3.3	EN 15020:2006 +A1:2010	relevant cl. ⁶
70	Main circuit breaker – coordination of protection	5.3.12	EN 50388:2012 and EN 50388:2012/AC:2013	11
71	Wheels – verification method decision criteria further verification method thermomechanical behaviour	6.1.3.1	EN 13979-1:2003 +A2:2011	7.2.1, 7.2.2 7.2.3 7.3 6
	Wheels – verification method Further verification method			7.3
	Wheels – verification method Thermomechanical behaviour			6
72	Wheel slide protection – method of verification test programme	6.1.3.2	EN 15595:2009 +A1:2011	5 only 6.2.3 of 6.2
	Wheel slide protection – test programme			only 6.2.3 of 6.2
73	Head lamps – colour luminous intensity	6.1.3.3	EN 15153-1:2013 +A1:2016	6.3 6.4
	Head lamps – luminous intensity			6.4
74	Marker lamps – colour luminous intensity	6.1.3.4	EN 15153-1:2013 +A1:2016	6.3 6.4
	Marker lamps – luminous intensity			6.4
75	Tail lamps – colour luminous intensity	6.1.3.5	EN 15153-1:2013 +A1:2016	6.3 6.4
	Tail lamps – luminous intensity			6.4
76	Horn – sounding sound pressure level	6.1.3.6	EN 15153-2:2013	6 6
	Horn – sound pressure level			6
77	Pantograph – static contact force	6.1.3.7	EN 50367:2012 and EN 50367:2012/AC:2013	7.2
78	Pantograph - limit value	6.1.3.7	EN 50119:2009 and EN 50119:2009/A1:2013	5.1.2
79	Pantograph – verification method	6.1.3.7	EN 50206-1:2010	6.3.1
80	Pantograph – dynamic behaviour	6.1.3.7	EN 50318:2002	relevant cl. ⁶
81	Pantograph – interaction characteristics	6.1.3.7	EN 50317:2012 and EN 50317:2012/AC:2012	relevant cl. ⁶



Index N°	UTP/ TSI		Normative document	
	Characteristics to be assessed	Point	Document N°	Mandatory points
82	Contact strips – verification method	6.1.3.8	EN 50405:2015 06	5.2.2, 5.2.3, 5.2.4, 5.2.6, 5.2.7.2, 7.3, 7.4, 7.6, 7.7
83	Safety against derailment running on twisted track	6.2.3.3	EN 14363:2016 05	4.5, 6.1
84	Running dynamic behaviour – method of verification assessment of criteria conditions of assessment	6.2.3.4	EN 14363:2016 05	4, 5, 7 relevant cl.⁶ relevant cl.⁶
85	Equivalent conicity – rail section definitions	6.2.3.6	EN 13674-1:2011	relevant cl. ⁶
86	Equivalent conicity – wheel profile definitions	6.2.3.6	EN 13715:2006 +A1:2010	relevant cl. ⁶
87	Wheelset – assembly	6.2.3.7	EN 13260:2009 +A1:2010 +A2:2012	3.2.1
88	Wheelset – axles, method of verification decision criteria	6.2.3.7	EN 13103:2009 +A1:2010 +A2:2012	4, 5, 6 7
	Wheelset – axles, decision criteria			7
89	Wheelset – axles, method of verification decision criteria	6.2.3.7	EN 13104:2009 +A1:2010	4, 5, 6 7
	Wheelset – axles, decision criteria			7
90	Axle boxes/bearings	6.2.3.7	EN 12082:2007 +A1:2010	6
91	Emergency braking performance	6.2.3.8	EN 14531-1:2005	5.11.3
92	Service braking performance	6.2.3.9	EN 14531-1:2005	5.11.3
93	Wheel slide protection, method of verification of performance	6.2.3.10	EN 15595:2009 +A1:2011	6.4
94	Slipstream effect – full scale tests meteorological conditions, sensors, sensor accuracy, selection of valid data and processing of the data	6.2.3.13	EN 14067-4:2005 +A1:2009	8.5.2 6.2.2.1
	Slipstream effect – simplified assessment			4.2.4 and table 7



Index N°	UTP/ TSI		Normative document	
	Characteristics to be assessed	Point	Document N°	Mandatory points
95	Head pressure pulse – method of verification CFD Moving model	6.2.3.14	EN 14067-4:2013 05 +A1:2009	6.1.2.1 5.5.2
	<u>Head pressure pulse – CFD</u>			5.3 5.4.3 <u>6.1.2.4</u>
	<u>Head pressure pulse – moving model</u>			<u>6.1.2.2</u>
	<u>Head pressure pulse – simplified assessment method</u>			<u>4.1.4 and table 4</u>
96	Maximum pressure variations – distance x_p between the entrance portal and the measuring position, the definitions of Δp_{Fr} , Δp_N , Δp_T , the minimum tunnel length	6.2.3.15	EN 14067-5:2006 +A1:2010	relevant cl. ⁶
97	Horn – sound pressure level	6.2.3.17	EN 15153-2:2013 <u>+A1:2016</u>	5
98	Maximum power and current from the overhead contact line – method of verification	6.2.3.18	EN 50388:2012 <u>and EN 50388:2012/AC:2013</u>	15 4.3
99	Power factor – method of verification	6.2.3.19	EN 50388:2012 <u>and EN 50388:2012/AC:2013</u>	15 4.2
100	Current collection dynamic behaviour – dynamic tests	6.2.3.20	EN 50317:2012 <u>and EN 50317:2012/AC:2012</u>	relevant cl. ⁶
101	Windscreen – characteristics	6.2.3.22	EN 15152:2007	6.2.1 to 6.2.7
102	Structural strength	<u>Appendix C Section C.1</u>	EN 12663-2:2010	5.2.1 <u>to</u> -5.2.4
<u>103</u>	<u>NOT USED</u>			
103	On-board energy measurement system	Appendix D	EN 50463-2:2012	relevant cl.⁶
<u>104</u>	<u>NOT USED</u>			
104	On-board energy measurement system	Appendix D	EN 50463-3:2012	relevant cl.⁶
<u>105</u>	<u>NOT USED</u>			
105	On-board energy measurement system	Appendix D	EN 50463-5:2012	relevant cl.⁶
<u>106</u>	<u>NOT USED</u>			
<u>107</u>	<u>Design values for new wheel profiles – evaluation of the equivalent conicity</u>	<u>6.2.3.6</u>	<u>EN 14363:2016</u>	<u>Annexes O and P</u>



Index N°	UTP/ TSI		Normative document	
	Characteristics to be assessed	Point	Document N°	Mandatory points
108	Slipstream effects – Requirements	4.2.6.2.1	EN 14067-4:2013	4.2.2.1, 4.2.2.2, 4.2.2.3 and 4.2.2.4
109	Head pressure pulse – Requirements	4.2.6.2.2	EN 14067-4:2013	4.1.2
110	End coupling – Compatibility between units –manual UIC type	4.2.2.2.3	EN 16839:2017	5, 6 7, 8
111	‘Single pole’ power supply line	4.2.11.6	CLC/TS 50534:2010	Annex A
112	Communication protocols	4.2.12.2	IEC 61375-1:2012	relevant cl.⁶
113	Gangways-Flange intercommunication connections	6.2.7a	EN 16286-1:2013	Annexes A and B
114	Physical interface between units for the signal transmission	6.2.7a	UIC 558, January 1996	Plate 2
115	Marking: length over buffers and electric power supply	6.2.7a	EN 15877-2:2013	4.5.5.1 4.5.6.3
116	On-board location function- Requirements	4.2.8.2.8.1	EN 50463-3:2017	4.4
117	Energy measurement function – accuracy for active energy measurement:	4.2.8.2.8.2	EN 50463-2:2017	4.2.3.1 and 4.2.3.4
	Energy measurement function – Class designations			4.3.3.4, 4.3.4.3 and 4.4.4.2
	Energy measurement function – Assessment	6.2.3.19b		5.4.3.4.1, 5.4.3.4.2, 5.4.4.3.1, Table 3, 5.4.3.4.3.1 and 5.4.4.3.2.1
118	Energy measurement function: consumption point identification – Definition	4.2.8.2.8.3	EN 50463-1:2017	4.2.5.2
119	Interface protocols between on- board energy measurement system (EMS) and on-ground data collection system (DCS) – Requirements	4.2.8.2.8.4	EN 50463-4:2017	4.3.3.1, 4.3.3.3, 4.3.4, 4.3.5, 4.3.6 and 4.3.7
120	Energy measurement function: mean temperature coefficient of each device – Assessment methodology	6.2.3.19b	EN 50463-2:2017	5.4.3.4.3.2 and 5.4.4.3.2.2

 OTIF	Uniform Technical Prescription (UTP)		UTP LOC&PAS	
	LOCOMOTIVES AND PASSENGER ROLLING STOCK		Page 264 of 272	
Status: DRAFT	Version: 03	TECH-20041 Annex	Original: EN	Date: 20.10.2020

Index N°	UTP/ TSI		Normative document	
	Characteristics to be assessed	Point	Document N°	Mandatory points
121	The compiling and handling of data within the data handing system – Assessment methodology	6.2.3.19b	EN 50463-3:2017	5.4.8.3, 5.4.8.5 and 5.4.8.6
122	On-board energy measurement system-Tests	6.2.3.19b	EN 50463-5:2017	5.3.3 and 5.5.4

⁶ clauses of the standard that are in direct relationship to the requirement expressed in the clause of the

UTP

~~TSI~~

indicated in column 3.

 OTIF	Uniform Technical Prescription (UTP)		UTP LOC&PAS	
	LOCOMOTIVES AND PASSENGER ROLLING STOCK		Page 265 of 272	
Status: DRAFT	Version: 03	TECH-20041 Annex	Original: EN	Date: 20.10.2020

J.2. Technical documents (available on ERA website)

Index N°	UTP/TSI		ERA technical document	
	Characteristics to be assessed	Point	Mandatory ref Document N°	Points
1	Interface between control -command signalling trackside and other subsystems	4.2.3.3.1	ERA/ERTMS/033281 rev 4.0 ⁵⁷	3.1 & 3.2
<u>2</u>	<u>Friction elements for wheel tread brake for freight wagons</u>	<u>7.1.4.2</u>	<u>ERA/TD/2013-02/INT v.3.0</u> ⁵⁸	<u>All</u>
2	Rolling stock dynamic behaviour	4.2.3.4	ERA/TD/2012-17/INT rev 2.0 ⁵⁹	All
3	Interface between the ETCS track side system for control command and signalling and on-board equipment	4.3.4.	UNISIG-SUBSET-034 ⁶⁰	All

⁵⁷ www.era.europa.eu

⁵⁸ www.era.europa.eu

⁵⁹ www.era.europa.eu

⁶⁰ www.era.europa.eu

 OTIF	Uniform Technical Prescription (UTP)		UTP LOC&PAS	
	LOCOMOTIVES AND PASSENGER ROLLING STOCK		Page 266 of 272	
Status: DRAFT	Version: 03	TECH-20041 Annex	Original: EN	Date: 20.10.2020

APPENDIX K PROVISIONS FOR THE SAFE OPERATION OF ROLLING STOCK

the provisions in this appendix are related to the correct operation of rolling stock within its conditions and limits of use. this appendix has no equivalence in the LOC&PAS TSI, because in the EU specific provisions are set out in the OPE TSI. this appendix is foreseen to be repealed at the moment that a UTP OPE enters into force.

Not used⁶¹.

Documentation for drivers

The railway undertaking operating the train must supply the driver with all the necessary information and documentation required to carry out his duties. This information must take into account the necessary elements for operation in normal, degraded and emergency situations for the routes to be worked over and the rolling stock used on those routes.

Documentation for railway undertaking staff other than drivers

The railway undertaking operating the train must supply all members of its staff (whether on the train or otherwise) who undertake safety-critical tasks with all the rolling stock specific information it deems appropriate to such tasks. Such information shall be applicable in both normal and degraded operation.

Knowledge of rolling stock

A process must be defined to ensure the acquisition and retention of vehicle knowledge by the train crew.

Front end

Where a coach is used as the front end of a train, the railway undertaking operating the train must provide the means of indicating the front end of a train in

⁽⁶²⁾

4.2.1.2. Documentation for drivers

The railway undertaking operating the train must supply the driver with all the necessary information and documentation required to carry out his duties.

This information must take into account the necessary elements for operation in normal, degraded and emergency situations for the routes to be worked over and the rolling stock used on those routes.

4.2.1.3. Documentation for railway undertaking staff other than drivers

The railway undertaking must provide all members of his staff (whether on train or otherwise) who undertake safety-critical tasks involving a direct interface with the staff, equipment or systems of the infrastructure manager with the rules, procedures, rolling stock and route specific information it deems appropriate to such tasks. Such information shall be applicable in both normal and degraded operation.

4.6.3.2.3.2. Knowledge of rolling stock

The railway undertaking must define the process for the acquisition and retention of traction and rolling stock knowledge by its train crew.

4.2.2.1.2. Front end

The railway undertaking must ensure that an approaching train is clearly visible and recognisable as such, by the presence and layout of its lit white front-end lights.

⁶¹- [Appendix K has been replaced by the UTP on train composition and rout compatibility checks \(UTP TCRC\).](#)

⁶²- The corresponding EU requirements are set out in Commission Decision of 14 November 2012 concerning the technical specification for interoperability relating to the 'operation and traffic management' subsystem of the rail system in the European Union and amending Decision 2007/756/EC (2012/757/EC (OPE TSI)) OJ L 345, 15.12.2012.



compliance with the rules of the network on which the train is operated.

The forward facing front end of the leading vehicle of a train must be fitted with three lights in an isosceles triangle, as shown below. These lights must always be lit when the train is being driven from that end.

The forward facing front-end of the leading vehicle of a train must be fitted with three lights in an isosceles triangle, as shown below. These lights must always be lit when the train is being driven from that end.

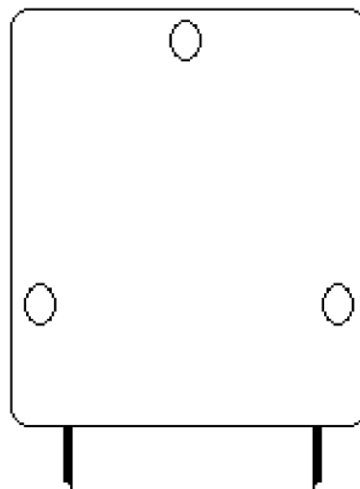

The front lights must optimise train detectability (for example, for track workers and those using public crossings) (marker lights), provide sufficient visibility for the train driver (illumination of the line ahead, lineside information markers/boards, etc.) (head lights) by night and during low light conditions and must not dazzle the drivers of oncoming trains.

The front lights must optimise train detectability (for example, to track workers and those using public crossings) (marker lights), provide sufficient visibility for the train driver (illumination of the line ahead, lineside information markers/boards, etc.) (head lights) by night and during low light conditions and must not dazzle the drivers of oncoming trains.

The spacing, the height above rails, the colour and intensity of the lights, the dimensions and shape of the emitted beam are defined in clauses 4.2.7.1.1 and 4.2.7.1.2.

The spacing, the height above rails, the diameter, the intensity of the lights, the dimensions and shape of the emitted beam in both day and night time operation are defined in the rolling stock TSI (hereinafter referred to as 'RST TSI').

Rear end

4.2.2.1.3. Rear end

The railway undertaking operating the train must provide the required means of indicating the rear of a train in compliance with the rules of the network on which the vehicle is operated. The rear end signal must only be exhibited on the rear of the last vehicle of the train.

The railway undertaking must provide the required means of indicating the rear of a train.

4.2.2.1.3.1 Passenger trains

The rear end indication of a passenger train must consist of 2 steady red lights at the same height above buffer on the transversal axis.

 OTIF	Uniform Technical Prescription (UTP)		UTP LOC&PAS	
	LOCOMOTIVES AND PASSENGER ROLLING STOCK		Page 268 of 272	
Status: DRAFT	Version: 03	TECH-20041 Annex	Original: EN	Date: 20.10.2020

The spacing, the height above rails, the colour and intensity of the tail lights, the dimensions and shape of the emitted beam are defined in clause 4.2.7.1.3

Safety of passengers

The railway undertaking operating the train must ensure that passenger transport is undertaken safely at the departure and during the journey.

Train composition

Train composition shall be the responsibility of the railway undertaking. Rules and procedures shall be defined which must be followed by the staff so as to ensure that the train complies with the allocated path.

UTP PRM requirements must be taken into account in train composition.

Train composition requirements must also take into account the following elements:

- a) the vehicles
 - all vehicles in the train must comply with all the requirements applicable on the routes over which the train will run;
 - all vehicles on the train must be fit to run at the maximum speed at which the train is scheduled to run;
- b) all vehicles on the train must currently be within their specified maintenance interval and remain so for the duration (in terms of both time and distance) of the journey being undertaken;
- c) the train
 - the combination of vehicles forming a train must comply with the technical constraints of the route concerned and be within the maximum length permissible for forwarding and receiving terminals.
- d) the railway undertaking is responsible for ensuring that the train is technically fit for the journey to be undertaken and remains so throughout the journey.
- e) the weight and axle load
- f) the weight of the train must be within the maximum permissible for the section of route, the strength of the couplings, the traction power and other relevant characteristics of the train. Axle load limitations must be respected.

4.2.2.4.2. Safety of passengers

The railway undertaking must ensure that passenger transport is undertaken safely at the departure and during the journey.

4.2.2.5. Train composition

The railway undertaking must define the rules and procedures to be followed by his staff so as to ensure that the train is in compliance with the allocated path.

Train composition requirements must take into account the following elements:

- a) *the vehicles*
 - *all vehicles in the train must be in compliance with all the requirements applicable on the routes over which the train will run;*
 - *all vehicles on the train must be fit to run at the maximum speed at which the train is scheduled to run;*
- b) *all vehicles on the train must be currently within their specified maintenance interval and will remain so for the duration (in terms of both time and distance) of the journey being undertaken;*
- c) *the train*
 - *the combination of vehicles forming a train must comply with the technical constraints of the route concerned and be within the maximum length permissible for forwarding and receiving terminals.*
- d) *the railway undertaking is responsible for ensuring that the train is technically fit for the journey to be undertaken and remains so throughout the journey.*
- e) *the weight and axle load*
- f) *the weight of the train must be within the maximum permissible for the section of route, the strength of the couplings, the traction*

 OTIF	Uniform Technical Prescription (UTP)		UTP LOC&PAS	
	LOCOMOTIVES AND PASSENGER ROLLING STOCK		Page 269 of 272	
Status: DRAFT	Version: 03	TECH-20041 Annex	Original: EN	Date: 20.10.2020

- g) the maximum speed of the train
- the maximum speed at which the train can run must take into account any restrictions on the route(s) concerned, braking performance, axle load and vehicle type.
- h) the kinematic envelope
- i) the kinematic gauge of each vehicle (inclusive of any load) in the train must be within the maximum permissible for the section of route.

Minimum requirements of the braking system, Braking performance

All vehicles in a train must be connected to the continuous braking system. The first and last vehicles in any train must have the automatic brake operative⁶³. The railway undertaking operating the train must ensure that the train meets the required braking performance.

General requirement that the train is in running order

Processes shall be defined, which must be followed by the railway undertaking, to ensure that all safety-related on-train equipment is in a fully functional state and that the train is safe to run. In case of modification to the characteristics of the train affecting the ability to accommodate the train in its allocated path, procedures for running in degraded mode shall be defined.

The railway undertaking shall inform the infrastructure manager of any change which affects the performance of the train, or which may affect the ability to accommodate the train in its allocated path.

power and other relevant characteristics of the train. Axle load limitations must be respected.

- g) *the maximum speed of the train*
- the maximum speed at which the train can run must take into account any restrictions on the route(s) concerned, braking performance, axle load and vehicle type.*
- h) *the kinematic envelope*
- i) *the kinematic gauge of each vehicle (inclusive of any load) in the train must be within the maximum permissible for the section of route.*

4.2.2.6.1. Minimum requirements of the braking system

All vehicles in a train must be connected to the continuous automatic braking system as defined in the TSI Rolling Stock
The first and last vehicles (including any traction units) in any train must have the automatic brake operative.

4.2.2.6.2. Braking performance

The infrastructure manager must provide the railway undertaking with the actual performance required. This data shall include, if necessary, conditions of use of braking systems possibly affecting the infrastructure such as magnetic, regenerative and eddy-current brake.

4.2.2.7.1. General requirement that the train is in running order

The railway undertaking must define the process to ensure that all safety-related on-train equipment is in a fully functional state and that the train is safe to run.

The railway undertaking must inform the infrastructure manager of any modification to the characteristics of the train affecting its performance or any modification that might affect the ability to accommodate the train in its allocated path.

The infrastructure manager and the railway undertaking must define and keep up to date

⁶³ In operation / in working order / functioning

 OTIF	Uniform Technical Prescription (UTP)		UTP LOC&PAS	
	LOCOMOTIVES AND PASSENGER ROLLING STOCK		Page 270 of 272	
Status: DRAFT	Version: 03	TECH-20041 Annex	Original: EN	Date: 20.10.2020

Driver vigilance

A means of onboard monitoring of driver vigilance is necessary. This shall intervene to bring the train to a standstill if the driver does not react within a certain time.

Checks and tests before departure

Checks shall be defined which must be followed by the railway undertaking to ensure that any departure is undertaken safely (e.g. doors, load, brakes).

Degraded operation

Before operating on a network, the railway undertaking shall have procedures in place to be informed of and deal with situations of degraded operation.

These procedures shall enable the railway undertaking to:

- advise the infrastructure manager so that it can inform other users of the network
- process information received from the infrastructure manager to its own train drivers with respect to degraded operations.

Appropriate contingency measures shall be defined, published and made available.

conditions and procedures for train running in degraded mode.

4.2.2.9. Driver vigilance

A means of onboard monitoring of driver vigilance is necessary. This shall intervene to bring the train to a stand if the driver does not react within a certain time.

4.2.3.3.1. Checks and tests before departure

The railway undertaking must define the checks and tests to ensure that any departure is undertaken safely (e.g. doors, load, brakes).

4.2.3.6. Degraded operation

4.2.3.6.1. Advice to other users

The infrastructure manager in conjunction with the railway undertaking(s) must define a process to immediately inform each other of any situation that impedes the safety, performance and/or the availability of the rail network or rolling stock.

4.2.3.6.2. Advice to train drivers

In any case of degraded operation associated with the infrastructure manager's area of responsibility, the infrastructure manager must give formal instructions to drivers on what measures to take in order to safely overcome the degradation.

4.2.3.6.3. Contingency arrangements

The infrastructure manager in conjunction with all the railway undertakings operating over his infrastructure, and neighbouring infrastructure managers as appropriate, must define, publish and make available appropriate contingency measures and assign responsibilities based on the requirement to reduce any negative impact as a result of degraded operation.

The planning requirements and the response to such events must be proportional to the nature and potential severity of the degradation.

These measures, which must as a minimum include plans for recovering the network to 'normal' status, may also address:

— rolling stock failures (for example, those which could result in substantial traffic disruption, the procedures for rescuing failed trains);

 OTIF	Uniform Technical Prescription (UTP)		UTP LOC&PAS	
	LOCOMOTIVES AND PASSENGER ROLLING STOCK		Page 271 of 272	
Status: DRAFT	Version: 03	TECH-20041 Annex	Original: EN	Date: 20.10.2020

Managing an emergency situation

Before operating on a network, the railway undertaking shall have procedures in place to act appropriately in an emergency situation.

To this end the railway undertaking shall cooperate with authorities, other railway undertakings and the infrastructure manager to establish appropriate measures to manage emergency situations and restore the line to normal operation.

Such emergency situations shall typically cover:

- collisions,
- fires on train,
- evacuation of trains,
- accidents in tunnels,
- incidents involving dangerous goods,
- derailments.

The railway undertaking must provide the infrastructure manager with any specific information in respect of these circumstances, especially in respect to the recovery or re-railing of their trains.

Additionally, the railway undertaking must have processes to inform passengers about on-board emergency and safety procedures.

— *infrastructure failures (for example, when there has been a failure of the electric power or the conditions under which trains may be diverted from the booked route);*

— *extreme weather conditions.*

The infrastructure manager must establish and keep updated contact information for key infrastructure manager and railway undertaking staff who may be contacted in the event of service disruption leading to degraded operation. This information must include contact details both during and outside office hours.

The railway undertaking must submit this information to the infrastructure manager and advise the infrastructure manager of any changes to these contact details.

The infrastructure manager must advise all the railway undertaking(s) of any changes to his details.

4.2.3.7. Managing an emergency situation

The infrastructure manager must, in consultation with:

— *all railway undertakings operating over his infrastructure, or, where appropriate, representative bodies of railway undertakings operating over his infrastructure;*

— *neighbouring infrastructure managers, as appropriate;*

— *local authorities, representative bodies of the emergency services (including fire fighting and rescue) at either local or national level, as appropriate.*

define, publish and make available appropriate measures to manage emergency situations and restore the line to normal operation.

Such measures shall typically cover:

- *collisions,*
- *fires on train,*
- *evacuation of trains,*
- *accidents in tunnels,*
- *incidents involving dangerous goods,*
- *derailments.*

The railway undertaking must provide the infrastructure manager with any specific information in respect to these circumstances,

 OTIF	Uniform Technical Prescription (UTP)		UTP LOC&PAS	
	LOCOMOTIVES AND PASSENGER ROLLING STOCK		Page 272 of 272	
Status: DRAFT	Version: 03	TECH-20041 Annex	Original: EN	Date: 20.10.2020

Aid to train crew in the event of an incident or of a major rolling stock malfunction

Appropriate procedures shall be defined to assist the train crew in degraded situations in order to avoid or decrease delays caused by technical or other failures of the rolling stock (for example, lines of communication, measures to be taken in case of evacuation of a train).

especially in respect to the recovery or re-railing of their trains.

Additionally, the railway undertaking must have processes to inform passengers about on-board emergency and safety procedures.

4.2.3.8. Aid to train crew in the event of an accident or of a major rolling stock malfunction

The railway undertaking must define appropriate procedures to assist the train crew in degraded situations in order to avoid or decrease delays caused by technical or other failures of the rolling stock (for example, lines of communication, measures to be taken in case of evacuation of a train).