



Organisation intergouvernementale pour les transports internationaux ferroviaires

Zwischenstaatliche Organisation für den internationalen Eisenbahnverkehr

Intergovernmental Organisation for International Carriage by Rail

Uniform Technical Prescription

Subsystem: Rolling stock

FREIGHT WAGONS

UTP WAG

Applicable from [Click here to enter a date.](#)

 OTIF	Uniform Technical Prescription (UTP)		UTP WAG	
	ROLLING STOCK - FREIGHT WAGONS		Page 2 of 148	
Status: DRAFT	Version 1	TECH-23020	Original: EN	Date: 17.5.2023

Amendments record

<u>Reference</u>	<u>Date</u>	<u>Description and comments</u>
<u>Version 1</u>	<u>17.5.2023</u>	<p><u>First draft for review by WG TECH 49.</u></p> <p><u>Changes are indicated in track changes compared to the version of UTP WAG that entered into force on 1 January 2022.</u></p> <p><u>The following EU document has been used as input:</u></p> <ul style="list-style-type: none"> - <u>Draft amendments to Commission Regulation (EU) No 321/2013 of 13 March 2013 as last amended by [add new reference], as voted on by the EU's Railway Interoperability and Safety Committee.</u> <p><u>Main amendments include:</u></p> <ul style="list-style-type: none"> - <u>Addition of requirements related to derailment prevention and derailment detection functions.</u> - <u>Appendix D is a table with references to standards used. References to standard are replaced by references to Appendix D throughout the text.</u> - <u>Deletion of the existing Appendix H, which was a transcription of ERA/ERTMS/033281 concerning interfaces with control command and signalling system. Instead, the text refers to the ERA technical document listed in Appendix D.2 Index [A]. This is the same approach as in the UTP LOC&PAS.</u> - <u>New requirements related to combined transport, including a new Appendix H with codification of units intended to be used in combined transport.</u> - <u>Editorial corrections, improvements and modifications throughout the text.</u>

 OTIF	Uniform Technical Prescription (UTP) ROLLING STOCK - FREIGHT WAGONS			UTP WAG Page 3 of 148
	Status: DRAFT	Version 1	TECH-23020	Original: EN

APTU Uniform Rules (Appendix F to COTIF 1999)

Uniform Technical Prescription **applicable to the subsystem:** **“Rolling stock - FREIGHT WAGONS”** **(UTP WAG)**

This UTP has been developed in accordance with COTIF in the version of 1 March 2019 and in particular with Articles 3, 4, 6, 7, 7a and 8 of the APTU Uniform Rules (Appendix F to COTIF).

For definitions, see also Article 2 of the APTU Uniform Rules and Article 2 of the ATMF Uniform Rules (Appendix G to COTIF).

0. EQUIVALENCE

Following their adoption by the Committee of Technical Experts, the OTIF regulations included in this document are declared equivalent to the corresponding EU regulations within the meaning of Article 13 § 4 of [the APTU UR](#) and Article 3a of [the ATMF UR](#), in particular with:

- The TSI for freight wagons Commission Regulation (EU) No 321/2013 of 13 March 2013 as last amended by ~~Commission Implementing Regulation (EU) 2020/387 of 9 March 2020~~ [\[add new reference\]](#), hereinafter referred to as the WAG TSI.

The objectives and scope of COTIF and the EU law concerning railways are not identical and it has therefore been necessary to use different terminology for concepts that have a similar, but not identical meaning. The following table lists the terms used in this UTP and the corresponding terms used in the WAG TSI:

 OTIF	Uniform Technical Prescription (UTP)			UTP WAG
	ROLLING STOCK - FREIGHT WAGONS			Page 4 of 148
Status: DRAFT	Version 1	TECH-23020	Original: EN	Date: 17.5.2023

This UTP	WAG TSI
Uniform Technical Prescription (UTP)	Technical Specification of Interoperability (TSI)
Admission to international traffic	Authorisation for placing on the market
elements of construction	interoperability constituents
The declaration of conformity	The EC declaration of conformity
Type examination	EC type examination
type or design examination certificate	EC type or design examination certificate
UTP verification procedure	EC verification procedure
UTP declaration of verification	EC declaration of verification
UTP Certificate of verification	EC Certificate of verification
Contracting State	Member State
Assessing eEntity	Notified Body

Where provisions in this UTP and the WAG TSI differ in substance, the respective texts are in a 2-column format. The left-hand column and the full width texts show the UTP provisions (OTIF regulations) and the right-hand column shows the European Union TSI texts. Texts in the right-hand column are strictly for information only. For EU law, consult the Official Journal of the European Union.

Where differences between texts of this UTP and the European Union WAG TSI are either editorial, or not substantive, or concern the list of terms quoted above, the WAG TSI texts are not generally reproduced. The TSI texts may however be reproduced to improve clarity and readability.

 OTIF	Uniform Technical Prescription (UTP)			UTP WAG
	ROLLING STOCK - FREIGHT WAGONS			Page 5 of 148
Status: DRAFT	Version 1	TECH-23020	Original: EN	Date: 17.5.2023

1. INTRODUCTION

A Uniform Technical Prescription (UTP) is a set of rules relating to a subsystem or a part of it, as defined in [the APTU UR](#) in order to further the aims as laid down in Article 3 of [the APTU UR](#) and:

- to ensure the interoperability of the rail system, and
- to meet the essential requirements.

A Technical Specification for Interoperability (TSI) is a specification that covers a subsystem (or part of it) as described in Article 2(11) of Directive (EU) 2016/797 in order:

1.1 Technical scope

This UTP shall apply to freight wagons as defined in Section 2 of the present UTP which meet the criteria set out in the present section.

This UTP shall apply to freight wagons with a maximum operating speed lower than or equal to 160 km/h and a maximum axle load lower than or equal to 25 t.

This UTP shall apply to freight wagons which are intended to be operated on one or more of the following nominal track gauges: 1435 mm, 1524 mm, 1600 mm, and 1668 mm.

This UTP shall not apply to freight wagons operating mainly on the 1520 mm track gauge, which may occasionally be operated on 1524 mm track gauge.

This UTP shall apply to all new freight wagons intended for use in international traffic, taking into account section 7 of this UTP.

⁽¹⁾

The TSI shall apply to the 'rolling stock – freight wagons' subsystem as described in point 2.7 of Annex II to Directive (EU) 2016/797.

The TSI shall apply to freight wagons with a maximum operating speed lower than or equal to 160 km/h and a maximum axle load lower than or equal to 25 t.

The TSI shall apply to freight wagons which are intended to be operated on one or more of the following nominal track gauges: 1435 mm, 1524 mm, 1600 mm, and 1668 mm. The TSI shall not apply to freight wagons operating mainly on the 1520 mm track gauge, which may occasionally be operated on 1524 mm track gauge.

~~(2)~~ The TSI shall apply to all new freight wagon rolling stock of the European Union's rail system, taking into account Section 7 of the Annex.

¹ ~~Article 2 of~~ *Text in italics in point 1.1 is quoted from* Commission Regulation (EU) No 321/2013 *of 13 March 2013 as last amended by* [\[add new reference\]](#) *concerning the technical specification for interoperability relating to the subsystem 'rolling stock – freight wagons' enacting the WAG TSI as last amended by Commission Implementing Regulation (EU) 2020/387 of 9 March 2020*

² ~~Article 3 of Commission Regulation (EU) No 321/2013 enacting the WAG TSI as last amended by Commission Implementing Regulation (EU) 2020/387 of 9 March 2020~~

 OTIF	Uniform Technical Prescription (UTP)			UTP WAG
	ROLLING STOCK - FREIGHT WAGONS			Page 6 of 148
Status: DRAFT	Version 1	TECH-23020	Original: EN	Date: 17.5.2023

The present UTP shall also apply to existing freight wagon rolling stock:

- (a) when it is renewed or upgraded in accordance with [Article 10 of the ATMF UR](#) ~~Article 10~~,
- (b) with regard to specific provisions, such as the traceability of axles in point 4.2.3.6.4 and the maintenance plan in point 4.5.3.
- (c) with regard to the marking ‘GE’ as depicted in point 5 of Appendix C of this UTP, wagons of the existing fleet marked RIV in accordance with Article 19 § 2 of the ATMF UR and which have the technical characteristics to be eligible for the ‘GE’ marking may receive this ‘GE’ marking without any additional assessment or new admission. Wagons which have been admitted in accordance with previous versions of the UTP WAG or with equivalent EU rules⁴ and which have the technical characteristics to be eligible for the ‘GE’ marking may also receive this marking ‘GE’ without any additional assessment or new admission. The use of this marking in wagons in operation remains under the responsibility of the railway undertakings;
- (d) when the area of its use is extended, in which case the provisions of Section 7.2.2.4 shall apply.

The TSI set out in the Annex shall also apply to existing freight wagon rolling stock:

- (a) when it is renewed and upgraded in accordance with section 7.2.2 of the Annex to this Regulation³, or*
- (b) with regard to specific provisions, such as the traceability of axles in point 4.2.3.6.4 and the maintenance plan in point 4.5.3.*
- (c) with regards to the marking ‘GE’ as depicted in point 5 of Appendix C of the Annex, wagons of the existing fleet which have been authorised in accordance with Commission Decision 2006/861/EC as amended by Decision 2009/107/EC or with Decision 2006/861/EC as amended by Decisions 2009/107/EC and 2012/464/EU and meeting the conditions set out in point 7.6.4 of Decision 2009/107/EC may receive this marking ‘GE’ without any additional third party assessment or new authorisation for placing on the market. The use of this marking in wagons in operation remains under the responsibility of the railway undertakings;*
- (d) when the area of use is extended in accordance with art. 54(3) of Directive (EU) 2016/797, provisions in Section 7.2.2.4 of the Annex to this Regulation shall apply.*

1.2 Geographical scope

~~The geographical scope of this~~

~~This UTP comprises~~ applies to vehicles intended for use on all lines open to, or used for international traffic, taking into account the limitations concerning the track gauge set out in Section 1.1.

~~This Regulation applies to TSI~~ is the entire European Union’s rail system as set out in the section 1 of Annex I to Directive (EU) 2016/797, taking into account the limitations concerning the track gauge set out in Article 2.

³ ~~Commission Regulation (EU) No 321/2013 enacting the WAG TSI as last amended by Commission Implementing Regulation (EU) 2020/387 of 9 March 2020~~

⁴ ~~Commission Decision 2006/861/EC as amended by Decision 2009/107/EC, Decision 2006/861/EC as amended by Decisions 2009/107/EC and 2012/464/EU and meeting the conditions set out in point 7.6.4 of Decision 2009/107/EC~~ The equivalence between a previous versions of the UTP WAG and the corresponding WAG TSI are defined in each version of the UTP WAG.

 OTIF	Uniform Technical Prescription (UTP)			UTP WAG
	ROLLING STOCK - FREIGHT WAGONS			Page 7 of 148
Status: DRAFT	Version 1	TECH-23020	Original: EN	Date: 17.5.2023

1.3 Content of this document

In accordance with [Article 8 of the APTU UR—Appendix F to the Convention](#), this UTP: | In accordance with Article 4(3) of Directive (EU) 2016/797, this TSI:

- (a) ~~covers the ‘rolling stock-freight wagons’ subsystem~~~~indicates its intended scope (Chapter 2);~~
- (b) lays down essential requirements for the part of the rolling stock subsystem concerned and for its interfaces vis-à-vis other subsystems (Chapter 3);
- (c) establishes the functional and technical specifications to be met by the subsystem and its interfaces vis-à-vis other subsystems (Chapter 4);
- (d) determines the interoperability constituents and interfaces which must be covered by European specifications, including European standards, which are necessary to achieve interoperability within the rail system (Chapter 5);
- (e) states, in each case under consideration, which procedures are to be used in order to assess the conformity with the provisions of the UTP (Chapter 6); | or the suitability for use of the interoperability constituents and the ‘EC’ verification of the subsystems (Chapter 6);
- (f) indicates the strategy for implementing the UTP (Chapter 7);
- (g) indicates, for the staff concerned, the professional qualifications and health and safety conditions at work that are required for the operation and maintenance of the above subsystem, as well as for the implementation of this UTP (Chapter 4).

2. SCOPE AND DEFINITION OF SUBSYSTEM

2.1 Scope

This UTP is applicable to wagons as defined in Article 2 (g) of [the APTU UR—Appendix F to the Convention](#), which are part of the subsystem Rolling Stock as defined in UTP GEN-B, and which are intended to be used in international traffic.

~~The w~~~~Wagons in accordance with this~~~~s~~ UTP ~~are subject to~~~~is applicable to~~ the [UTP TCRC subsystem “Operation and traffic management”](#) with respect to their use ~~of freight wagons~~ within their limits and conditions of use and [with respect to their integration for the in](#) ~~composition of trains with respect to freight wagons.~~

This TSI is applicable to “freight wagons including vehicles designed to carry lorries” as referred to in Annex I section 2 to Directive (EU) 2016/797 taking into account the limitations as set out in Article 2.

⁽⁵⁾

⁵ The EU requirements for the subsystem “Operation and traffic management” are set out in EU regulations, such as the OPE TSI.

 OTIF	Uniform Technical Prescription (UTP)			UTP WAG
	ROLLING STOCK - FREIGHT WAGONS			Page 8 of 148
Status: DRAFT	Version 1	TECH-23020	Original: EN	Date: 17.5.2023

The UTP Marking is applicable to the assignment of the Unique Vehicle Number for the purpose of vehicle registration. ⁽⁶⁾

In the following this part of the subsystem rolling stock is called “freight wagon” and belongs to the subsystem “rolling stock”

as set out in the APTU ~~Uniform Rules~~UR, UTP GEN-B. The other types of rolling stock listed in point 2.7 of UTP GEN-B are excluded from the scope of this UTP;

as set out in Annex II to Directive (EU) 2016/797. The other vehicles listed in Section 2 of Annex I to Directive (EU) 2016/797 are excluded from the scope of this TSI;

this is especially the case for:

- (a) ~~special vehicles~~~~mobile railway infrastructure construction and maintenance equipment;~~
- (b) vehicles designed to carry:
 - motor vehicles with their passengers on board, or
 - motor vehicles without passengers on board but intended to be integrated in passenger trains (car carriers);
- (c) vehicles which
 - increase their length in loaded configuration, and
 - their payload itself is part of the vehicle structure.

Note: see also section 7.1 for particular cases.

2.2 Definitions

The following definitions are used:

- (a) A “unit” is the generic term used to name the rolling stock. It is subject to the application of this UTP and therefore subject to assessment in accordance with UTP GEN-D. TSI, and therefore subject to the EC verification procedure.

A unit can consist of:

- a “wagon” that can be operated separately, featuring an individual frame mounted on its own set of wheels, or
 - a rake of permanently connected “elements”, those elements cannot be operated separately, or
 - “separate rail bogies connected to compatible road vehicle(s)” the combination of which forms a rake of a rail compatible system.
- (b) A “train” is an operational formation consisting of several units.

⁶ The European Vehicle Number is assigned according to the codes defined in Appendix 6 of Commission Decision 2007/756/EC as last amended by Commission Implementing Decision (EU) 2018/1614.

 OTIF	Uniform Technical Prescription (UTP)			UTP WAG
	ROLLING STOCK - FREIGHT WAGONS			Page 9 of 148
Status: DRAFT	Version 1	TECH-23020	Original: EN	Date: 17.5.2023

- (c) The “design operating state” covers all conditions under which the unit is intended to operate and its technical boundaries.

This design operating state may go beyond the specifications of this UTP⁷ in order that units may be used together in a train on the network according to the operating rules applicable to, or applied by the rail transport undertaking.

Such operating rules include measures relating to train composition and measures designed to comply with the conditions and limits of use for the wagon and to ensure that the requirements as set out in section 4.4 are met during operation.

This design operating state may go beyond the specifications of this TSI in order that units may be used together in a train on the network under the safety management system of a railway undertaking.

3. ESSENTIAL REQUIREMENTS

UTP GEN-A sets out the essential requirements that must be met by the subsystems and elements of construction. Table 1 indicates the basic parameters specified in the present UTP and their correlation to the essential requirements.

Article 3(1) of Directive (EU) 2016/797 ~~provides~~states, that the rail system its subsystems and their interoperability constituents ~~are to shall~~ meet the relevant essential requirements. The essential requirements are set out in general terms in Annex III ~~to that of~~ Directive ~~(EU) 2016/797~~. Table 1 ~~of this Annex~~ indicates the basic parameters specified in this TSI and their correspondence to the essential requirements as explained in Annex III to Directive (EU) 2016/797.

Table 1 Basic parameters and their correspondence to the essential requirements

Point	Basic parameter	Essential requirements				
		Safety	Reliability & availability	Health	Environment protection	Technical compatibility
4.2.2.1.1	End coupling	1.1.1, 1.1.3, 1.1.5, 2.4.1				
4.2.2.1.2	Inner coupling	1.1.1, 1.1.3, 2.4.1				

⁷ This means that a rail~~way-transport~~ undertaking may require that the vehicle ~~to-have~~ properties which go beyond the UTP requirements, if these properties are necessary for this rail transport undertaking to operate ~~the~~ vehicle. Such requirements may for example relate to compatibility with the other rolling stock operated by this rail~~way-transport~~ undertaking or ~~may relate~~ to how its operational activities are organised.

 OTIF	Uniform Technical Prescription (UTP)			UTP WAG
	ROLLING STOCK - FREIGHT WAGONS			Page 10 of 148
Status: DRAFT	Version 1	TECH-23020	Original: EN	Date: 17.5.2023

Point	Basic parameter	Essential requirements				
		Safety	Reliability & availability	Health	Environment protection	Technical compatibility
4.2.2.2	Strength of unit	1.1.1, 1.1.3, 2.4.1				
4.2.2.3	Integrity of the unit	1.1.1				
4.2.3.1	Gauging	1.1.1				2.4.3
4.2.3.2	Compatibility with load carrying capacity of lines	1.1.1				2.4.3
4.2.3.3	Compatibility with train detection systems	1.1.1				2.4.3
4.2.3.4	Axle bearing condition monitoring	1.1.1	1.2			2.4.3
4.2.3.5.1	Safety against derailment running on twisted track	1.1.1, 1.1.2, 2.4.1				2.4.3
4.2.3.5.2	Running dynamic behaviour	1.1.1 1.1.2				2.4.3
4.2.3.5.3	Derailment detection and prevention function	1.1.1 1.1.2				2.4.3
4.2.3.6.1	Structural design of bogie frame	1.1.1, 1.1.2, 1.1.3				
4.2.3.6.2	Characteristics of wheelsets	1.1.1, 1.1.2, 1.1.3				2.4.3

 OTIF	Uniform Technical Prescription (UTP)			UTP WAG
	ROLLING STOCK - FREIGHT WAGONS			Page 11 of 148
Status: DRAFT	Version 1	TECH-23020	Original: EN	Date: 17.5.2023

Point	Basic parameter	Essential requirements				
		Safety	Reliability & availability	Health	Environment protection	Technical compatibility
4.2.3.6.3	Characteristics of wheels	1.1.1, 1.1.2, 1.1.3				2.4.3
4.2.3.6.4	Characteristics of axles	1.1.1, 1.1.2, 1.1.3				
4.2.3.6.5	Axle box / bearings	1.1.1, 1.1.2, 1.1.3				
4.2.3.6.6	Automatic variable gauge systems	1.1.1, 1.1.2, 1.1.3	1.2			1.5
4.2.3.6.7	Running gear for manual change of wheelsets	1.1.1, 1.1.2, 1.1.3				
4.2.4.2	Brake - Safety requirements	1.1.1, 1.1.3	1.2 2.4.2			
4.2.4.3.1	Brake - General functional requirements	1.1.1 2.4.1	2.4.2			
4.2.4.3.2.1	Brake performance – In-service brake	1.1.1, 1.1.2, 2.4.1	2.4.2			1.5
4.2.4.3.2.2	Brake performance – Parking brake	2.4.1				2.4.3
4.2.4.3.3	Brake - Thermal capacity	1.1.1, 1.1.3, 2.4.1				2.4.3
4.2.4.3.4	Brake - Wheel slide protection (WSP)	2.4.1	2.4.2			
4.2.4.3.5	Friction elements for	1.1.1, 1.1.2,				2.4.3

 OTIF	Uniform Technical Prescription (UTP)			UTP WAG
	ROLLING STOCK - FREIGHT WAGONS			Page 12 of 148
Status: DRAFT	Version 1	TECH-23020	Original: EN	Date: 17.5.2023

Point	Basic parameter	Essential requirements				
		Safety	Reliability & availability	Health	Environment protection	Technical compatibility
	wheel tread brakes	1.1.3, 2.4.1				
4.2.5	Environ-mental conditions	1.1.1, 1.1.2				2.4.3
4.2.6.1	Fire safety	1.1.1, 1.1.4				
4.2.6.1.2.1	Fire safety Barriers	1.1.4		1.3.2	1.4.2	
4.2.6.1.2.2	Fire safety Materials	1.1.4		1.3.2	1.4.2	
4.2.6.1.2.3	Fire safety Cables	1.1.4, 1.1.5		1.3.2	1.4.2	
4.2.6.1.2.4	Fire safety – Flammable liquids	1.1.4		1.3.2	1.4.2	
4.2.6.2	Protection against electric hazard	1.1.5, 2.4.1				
4.2.6.3	Attachment device for rear-end signal	1.1.1				

The essential requirements 1.3.1, 1.4.1, 1.4.3 and 1.4.5 of

UTP GEN-A may fall under the scope of other legislation applicable in the Contracting State.⁸

Annex III to Directive (EU) 2016/797 fall under the scope of other Union legislation.

⁸ Essential requirement 1.4.4 on noise pollution is deemed to be met for all vehicle-related parameters if the UTP Noise has been complied with.

 OTIF	Uniform Technical Prescription (UTP)			UTP WAG
	ROLLING STOCK - FREIGHT WAGONS			Page 13 of 148
Status: DRAFT	Version 1	TECH-23020	Original: EN	Date: 17.5.2023

4. CHARACTERISATION OF THE SUBSYSTEM

4.1 Introduction

In accordance with UTP GEN-B, the rail system is divided into subsystems. Belonging to the subsystem rolling stock, freight wagons form a part of the rail system. The consistency of this system shall be verified.

The rail system, to which Directive (EU) 2016/797 applies and of which freight wagons form a part, is an integrated system whose consistency shall be verified.

This consistency shall be checked in particular with regard to the specifications of the rolling stock subsystem and the compatibility with the network (Section 4.2), its interfaces in relation to the other subsystems of the rail system in which it is integrated (Sections 4.2 and 4.3), as well as the initial operating and maintenance rules

(Sections 4.4 and 4.5).

(Sections 4.4 and 4.5) as requested by Article 15(4) of Directive (EU) 2016/797.

The technical file, as set out in

UTP, ~~General Provisions~~ GEN-C and Article 10 § 6 of ~~the~~ ATMF UR

Article 15(4) of Directive (EU) 2016/797 and in point 2.4 of Annex IV to ~~that~~ Directive, ~~(EU) 2016/797 (section 4.8),~~

shall contain in particular design related values concerning the compatibility with the network.

4.2 Functional and technical specifications of the subsystem

4.2.1 General

In light of the essential requirements in Chapter 3, the functional and technical specifications of the subsystem “rolling stock - freight wagons” are grouped and sorted out in the following points of this Chapter:

- Structures and mechanical parts,
- Gauging and vehicle track interaction,
- Brake,
- Environmental conditions,
- System protection.

Except where this is strictly necessary for the interoperability of the rail system and to meet the relevant essential requirements, the functional and technical specifications of the freight wagon and its interfaces do not impose the use of any particular technical solutions.

~~When the functional and technical specifications that are necessary in order to achieve interoperability and to meet the essential requirements, have not been developed concerning a particular technical aspect, this aspect is identified as an open point in the relevant point. As required in~~

~~Article 8 § 7 of APTU~~

~~Article 4(6) of Directive (EU) 2016/797~~

~~all open points are listed in Appendix A.~~

 OTIF	Uniform Technical Prescription (UTP)			UTP WAG
	ROLLING STOCK - FREIGHT WAGONS			Page 14 of 148
Status: DRAFT	Version 1	TECH-23020	Original: EN	Date: 17.5.2023

In Appendix C a set of conditions is specified. The conformity with this set of conditions is optional. If this option is selected the conformity shall be assessed by

<p>an Assessing eEntity in the meaning of Article 5 § 2 of the ATMF UR and UTP GEN-E, using the procedure as defined in Article 4 of the ATMF UR Article 4 and UTP GEN-D.</p>	<p>a notified body within the EC verification procedure.</p>
--	--

In accordance with

<p>Article 8 § 6 of the APTU UR,</p>	<p>Article 4(5) of Directive (EU) 2016/797,</p>
--	---

provisions may be made for specific cases for each UTP. Such provisions are indicated in Chapter 7.

As far as possible the assessment procedure for the requirements in section 4.2 is defined in Chapter 6. In these cases, the text of section 4.2 makes a reference to the corresponding points and sub points clauses of Chapter 6. If for a particular basic parameter, the separation of requirements and assessment procedures is not feasible, no reference is given.

4.2.2 Structures and mechanical parts

4.2.2.1 Mechanical Interface

4.2.2.1.1 End coupling

The end coupling is the mechanical interface between units forming a train.

The coupling system shall be designed in a way that no human presence between the units to be coupled / uncoupled shall be required whilst either one unit is moving.

End couplings shall be resilient and capable of withstanding the forces in accordance with the defined design operating state of the unit.

4.2.2.1.2 Inner coupling

The inner coupling is the mechanical interface between elements forming a unit.

The inner coupling shall be resilient and capable of withstanding the forces in accordance with the defined design operating state of the unit. The joint between two elements sharing the same running gear, is covered by point 4.2.2.2.

The longitudinal strength of the inner coupling(s) shall be equal to or higher than the one of the end coupling(s) of the unit.

4.2.2.2 Strength of unit

<p>The structure of a unit body, any equipment attachments and lifting and jacking points shall be designed such that no cracks, no significant permanent deformation or ruptures occur under the load cases defined in Chapter 5 of EN 12663-2:2010 the specification referenced in Appendix D Index [1].</p>	
---	--

In case of a rake of a rail compatible system composed of separate rail bogies connected to compatible road vehicles, the load cases may differ from those mentioned above, due to their bi-modal specification; in such a case, the load cases considered shall be described by the applicant based on a consistent set of specifications with consideration of the specific conditions of use related to train composition, shunting and operation.

The demonstration of conformity is described in point 6.2.2.1.

 OTIF	Uniform Technical Prescription (UTP)			UTP WAG
	ROLLING STOCK - FREIGHT WAGONS			Page 15 of 148
Status: DRAFT	Version 1	TECH-23020	Original: EN	Date: 17.5.2023

The lifting and jacking positions shall be marked on the unit. The marking shall comply with ~~point 4.5.14 of EN 15877-1:2012~~ [the specification referenced in Appendix D Index \[2\]](#).

Note: joining techniques are also deemed to be covered by the demonstration of conformity in accordance with point 6.2.2.1.

4.2.2.3 Integrity of the unit

The unit shall be designed so that all movable parts intended to close an aperture (access doors, tarpaulin, lids, hatches, etc.) are prevented against an unintentional movement of these parts.

Locking devices shall indicate their status (open/closed) and shall be visible outside the unit.

[Units intended to be used for combined transport and requiring a wagon compatibility code shall be equipped with devices for securing the Intermodal Loading Unit.](#)

4.2.3 Gauging and track interaction

4.2.3.1 Gauging

This point concerns the rules for calculation intended for sizing the rolling stock to run on one or several networks without interference risk.

The compliance of a unit with the intended reference profile including the reference profile for the lower part shall be established by one of the methods set out in ~~EN 15273 2:2013+A1:2016~~ [the specification referenced in Appendix D Index \[4\]](#).

The kinematic method, as described in ~~EN 15273 2:2013+A1:2016~~ [the specification referenced in Appendix D Index \[4\]](#) shall be used to establish conformity, if any, between the reference profile established for the unit and the respective target reference profiles G1, GA, GB and GC including those used for the lower part G11 and G12.

[Units intended to be used for combined transport shall be codified in accordance with the requirements of Appendix H and the specification referenced in Appendix D.2, index \[B\].](#)

4.2.3.2 Compatibility with load carrying capacity of lines

The vertical loading characteristics of the unit shall be determined in order to check compatibility with the load carrying capacity of lines.

The permissible payload a unit may carry, for axle loads up to and including 25t, shall be determined by application of ~~clauses 6.1 and 6.2 of EN 15528:2015~~ [the specification referenced in Appendix D Index \[5\]](#).

4.2.3.3 Compatibility with train detection systems

If the unit is intended to be compatible with one or more of the following train detection systems, this compatibility shall be established [in accordance with the provisions of the technical document referenced in Appendix D.2 Index \[A\]](#)

~~in accordance with the provisions of Appendix H of this UTP.~~ [according to the provisions of the ERA/ERTMS/033281 rev. 4.0. :](#)

 OTIF	Uniform Technical Prescription (UTP)			UTP WAG
	ROLLING STOCK - FREIGHT WAGONS			Page 16 of 148
Status: DRAFT	Version 1	TECH-23020	Original: EN	Date: 17.5.2023

The parameters listed in (a), (b) and (c) shall be recorded in the technical file.⁹

(a) Train detection systems based on track circuits [\(the electrical resistance of the wheelset can be assessed at IC level or at vehicle level\):](#)

- The greatest distance between two consecutive axles ⁽¹⁰⁾
- The greatest distance between buffer end and first axle
- The minimum axle load in all load conditions
- The electrical resistance between the running surfaces of the opposite wheels of a wheelset.

(b) Train detection systems based on axle counters:

- The greatest distance between two consecutive axles ⁽¹¹⁾
- The shortest distance between two consecutive axles
- The distance between the end axles of the wagon
- The distance between the end of the vehicle (e.g. buffer) and the first axle of the unit¹²
- The wheel diameter
- The metal-free space around wheels
- The characteristics of the wheel material regarding magnetic fields

(c) Train detection systems based on loop equipment:

- The metal-mass of the vehicle ⁽¹³⁾

[The specific cases for Contracting States which are also EU Member States are defined in section 7.7 of the CCS TSI.](#)

[The related specific cases](#)

⁹ The information included in the technical file is used by the rail-transportway undertaking to establish compatibility with the network on which it will operate the vehicle.

¹⁰ EU provisions included in [the-ERA/ERTMS/033281-rev. 4.0 technical document referenced in Appendix D.2 Index \[A\]](#).

¹¹ EU provisions included in [the-ERA/ERTMS/033281-rev. 4.0 technical document referenced in Appendix D.2 Index \[A\]](#).

¹² This value is used to define the distance between two consecutive axles of coupled wagons.

¹³ EU provisions included in [the-ERA/ERTMS/033281-rev. 4.0 technical document referenced in Appendix D.2 Index \[A\]](#).

 OTIF	Uniform Technical Prescription (UTP)			UTP WAG
	ROLLING STOCK - FREIGHT WAGONS			Page 17 of 148
Status: DRAFT	Version 1	TECH-23020	Original: EN	Date: 17.5.2023

[Specific cases for non-EU Contracting States are set out in section 7.3.2. of this UTP.](#)

4.2.3.4 Axle bearing condition monitoring

It shall be possible to monitor the axle bearing condition either by

- line side detection equipment or
- on-board equipment.

If the unit is intended to be capable of being monitored by line side equipment on the 1435 mm track gauge network the unit shall be compliant with ~~clauses 5.1 and 5.2 of EN 15437-1:2009~~ [the specification referenced in Appendix D Index \[6\]](#) in order to ensure sufficient visibility.

For units intended to be operated on the networks with track gauges of 1524 mm, 1600 mm, 1668 mm, the corresponding values in [Table 2](#) referring to the parameters of the ~~standard EN 15437-1:2009 specification referenced in Appendix D Index [6]~~ shall be applied.

Table 2 Target and prohibitive zone for units intended to be operated on particular networks

	Y_{TA} [mm]	W_{TA} [mm]	L_{TA} [mm]	Y_{PZ} [mm]	W_{PZ} [mm]	L_{PZ} [mm]
1524 mm (both areas are relevant)	1080±35	≥50	≥200	1080±5	≥140	≥500
	894±2	≥14	≥200	894±2	≥28	≥500
1600 mm	1110±2	>70	>180	1110±2	>125	>500
1668 mm	1176±10	≥55	≥100	1176±10	≥110	≥500

If the unit is intended to be capable of being monitored by on-board equipment, the following requirements shall apply:

- This equipment shall be able to detect a deterioration of any of the axle box bearings of the unit.
- The bearing condition shall be evaluated either by monitoring its temperature, or its dynamic frequencies or some other suitable bearing condition characteristic.
- The detection system shall be located entirely on board the unit, and diagnosis messages shall be available on board the unit.
- The diagnosis messages delivered and how they are made available shall be described in the operating documentation set out in section 4.4, and in the maintenance rules described in section 4.5.

4.2.3.5 Running safety

The dynamic behaviour of a vehicle has a strong influence on safety against derailment, running safety and track loading.

 OTIF	Uniform Technical Prescription (UTP)			UTP WAG
	ROLLING STOCK - FREIGHT WAGONS			Page 18 of 148
Status: DRAFT	Version 1	TECH-23020	Original: EN	Date: 17.5.2023

4.2.3.5.1 *Safety against derailment running on twisted track*

The unit shall be designed to ensure safe running on twisted track, taking into account specifically the transition phase between canted and level track and cross level deviations.

The demonstration of conformity is described in point 6.2.2.2.

4.2.3.5.2 *Running dynamic behaviour*

The unit shall be designed to provide safe movement up to the maximum design speed.

The running dynamic behaviour of a unit shall be proven either by

- following the procedures set out in ~~Chapter 4, 5 and 7 of EN 14363:2016~~ [the specification referenced in Appendix D Index \[7\]](#), or
- performing simulations using a validated model.

The demonstration of conformity is described in point 6.2.2.3.

Running dynamic behaviour is permitted to be assessed at interoperability constituent level in accordance with point 6.1.2.1. In this case, a specific test or simulation at subsystem level is not required.

4.2.3.5.3 *Derailment detection and prevention function*

The derailment detection and prevention function is intended to prevent derailments or to mitigate the consequences of a derailment of the unit.

If a unit is fitted with the derailment detection and prevention function, the requirements below shall be met.

4.2.3.5.3.1 *General requirements*

The function shall be able to detect either a derailment or conditions which are a precursor to derailment of the unit in accordance with one of the three sets of requirements set out in points 4.2.3.5.3.2, 4.2.3.5.3.3 and 4.2.3.5.3.4 below.

These requirements may be combined, as follows:

- 4.2.3.5.3.2 and 4.2.3.5.3.3
- 4.2.3.5.3.2 and 4.2.3.5.3.4

4.2.3.5.3.2 *Derailment prevention function (DPF)*

The DPF shall send a signal to the driver's cab of the locomotive hauling the train once a precursor to derailment is detected in the unit.

The signal enabling the DPF to be available at train level and its transmission between the unit, the locomotive and the other coupled unit(s) in a train shall be documented in the technical file.

4.2.3.5.3.3 *Derailment detection function (DDF)*

The DDF shall send a signal to the driver's cab of the locomotive hauling the train once the derailment is detected in the unit.

 OTIF	Uniform Technical Prescription (UTP)			UTP WAG
	ROLLING STOCK - FREIGHT WAGONS			Page 19 of 148
Status: DRAFT	Version 1	TECH-23020	Original: EN	Date: 17.5.2023

The signal enabling the DDF to be available at train level and its transmission between the unit, the locomotive and the other coupled unit(s) in a train shall be documented in the technical file.

4.2.3.5.3.4 Derailment detection and actuation function (DDAF)

The DDAF shall automatically activate a brake application when the derailment is detected, without possibility of overriding by the driver.

The risk of false derailment detections shall be limited to an acceptable level.

To this end, the DDAF shall be subject to a risk assessment in accordance with Implementing Regulation (EU) No 402/2013.

It shall be possible to deactivate the DDAF directly on the unit when the unit is stopped. That deactivation will release and isolate the DDAF from the brake system.

The DDAF shall indicate its status (activated/deactivated) and that status shall be visible from both sides of the unit. If this is not physically feasible, the DDAF shall indicate its status from at least one side and the other side of the wagon shall be marked in accordance with the specification referenced in Appendix D Index [2].

4.2.3.6 Running gear

The running gear guarantees to carry and guide the unit safely as well as to transmit braking forces where so required.

4.2.3.6.1 Structural design of bogie frame

The integrity of the structure of a bogie frame, all attached equipment and body to bogie connection shall be demonstrated based on methods as set out in ~~point 6.2 of EN 13749:2011~~ the specification referenced in Appendix D Index [9].

The integrity of the structure of a bogie frame is permitted to be assessed at interoperability constituent level in accordance with point 6.1.2.1. In this case a specific test or simulation at subsystem level is not required.

4.2.3.6.2 Characteristics of wheelsets

The wheelset assembly shall be able to transmit forces and torque between the fitted parts in accordance with the area of use.

The geometric dimensions of the wheelsets, as defined in figure 1, shall be compliant with limit values specified in table 3. These limit values shall be taken as design values and shall be stated as in-service limit values in the maintenance file described in section 4.5.

The demonstration of conformity is described in point 6.1.2.2.

 OTIF	Uniform Technical Prescription (UTP)		UTP WAG	
	ROLLING STOCK - FREIGHT WAGONS		Page 20 of 148	
Status: DRAFT	Version 1	TECH-23020	Original: EN	Date: 17.5.2023

Fig. 1 Symbols for wheelsets used in table 3

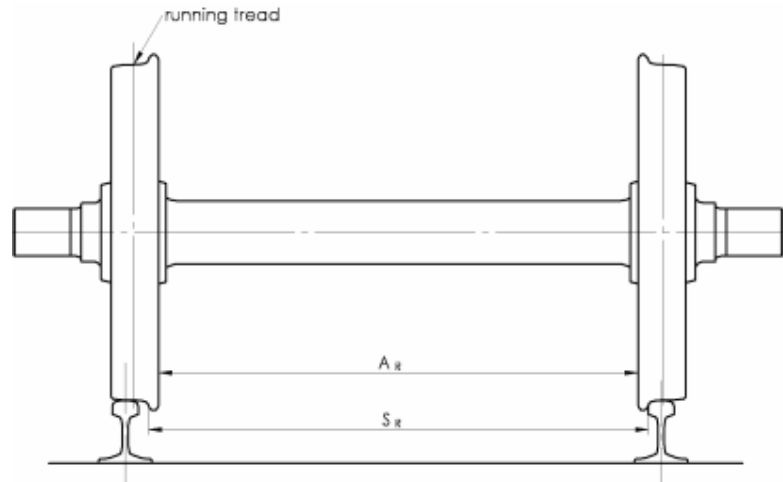



Table 3 Limits of use of the geometric dimensions of wheelsets

Designation		Wheel diam. D [mm]	Minimum value [mm]	Maximum value [mm]
1435 mm	Front-to-front dimension (S_R) $S_R = A_R + S_{d, \text{left}} + S_{d, \text{right}}$	$330 \leq D \leq 760$	1415	1426
		$760 < D \leq 840$	1412	1426
		$D > 840$	1410	1426
	Back to back distance (A_R)	$330 \leq D \leq 760$	1359	1363
		$760 < D \leq 840$	1358	1363
		$D > 840$	1357	1363
1524 mm	Front-to-front dimension (S_R) $S_R = A_R + S_{d, \text{left}} + S_{d, \text{right}}$	$400 \leq D < 840$	1492	1514
		$D \geq 840$	1487	1514
	Back to back distance (A_R)	$400 \leq D < 840$	1444	1448
		$D \geq 840$	1442	1448
1600 mm	Front-to-front dimension (S_R) $S_R = A_R + S_{d, \text{left}} + S_{d, \text{right}}$	$690 \leq D \leq 1016$	1573	1592
	Back to back distance (A_R)	$690 \leq D \leq 1016$	1521	1526

 OTIF	Uniform Technical Prescription (UTP)			UTP WAG
	ROLLING STOCK - FREIGHT WAGONS			Page 21 of 148
Status: DRAFT	Version 1	TECH-23020	Original: EN	Date: 17.5.2023

Designation		Wheel diam. D [mm]	Minimum value [mm]	Maximum value [mm]
1668 mm	Front-to-front dimension (S_R) $S_R = A_R + S_{d, \text{left}} + S_{d, \text{right}}$	$330 \leq D < 840$	1648 ¹⁴	1659
		$840 \leq D \leq 1250$	1643 ¹⁵	1659
	Back to back distance (A_R)	$330 \leq D < 840$	1592	1596
		$840 \leq D \leq 1250$	1590	1596

4.2.3.6.3 Characteristics of wheels

The geometrical dimensions of the wheels as defined in Figure 2 shall be compliant with limit values specified in table 4.

Table 4 Limits of use of the geometric dimensions of wheels

Designation		Wheel diam. D [mm]	Minimum value [mm]	Maximum value [mm]
1435 mm	Width of the rim (B_R) (with maximum BURR of 5 mm)	$D \geq 330$	133	140
	Thickness of the flange (S_d)	$330 \leq D \leq 760$	27,5	33
		$760 < D \leq 840$	25	33
		$D > 840$	22	33
	Height of the flange (S_h)	$330 \leq D \leq 630$	31,5	36
		$630 < D \leq 760$	29,5	36
		$D > 760$	27,5	36
Face of the flange (q_R)	$D \geq 330$	6,5	-	
1524 mm	Width of the rim (B_R) (with maximum BURR of 5 mm)	$D \geq 400$	134	140
	Thickness of the flange (S_d)	$400 \leq D < 760$	27,5	33
		$760 \leq D < 840$	25	33
		$D \geq 840$	22	33
		$400 \leq D < 630$	31,5	36

¹⁴ Two-axle wagons with axle load up to 22.5t the value shall be taken as 1651 mm

¹⁵ Two-axle wagons with axle load up to 22.5t the value shall be taken as 1651 mm

 OTIF	Uniform Technical Prescription (UTP)			UTP WAG
	ROLLING STOCK - FREIGHT WAGONS			Page 22 of 148
Status: DRAFT	Version 1	TECH-23020	Original: EN	Date: 17.5.2023

Designation		Wheel diam. D [mm]	Minimum value [mm]	Maximum value [mm]
	Height of the flange (S_h)	$630 \leq D < 760$	29,5	36
		$D \geq 760$	27,5	36
	Face of the flange (q_R)	$D \geq 400$	6,5	-
1600 mm	Width of the rim (BR) (with maximum BURR of 5 mm)	$690 \leq D \leq 1016$	137	139
	Thickness of the flange (S_d)	$690 \leq D \leq 1016$	26	33
	Height of the flange (S_h)	$690 \leq D \leq 1016$	28	38
	Face of the flange (q_R)	$690 \leq D \leq 1016$	6,5	-
1668 mm	Width of the rim (BR) (with maximum BURR of 5 mm)	$D \geq 330$	133	140
		$330 \leq D \leq 840$	27,5	33
	Thickness of the flange (S_d)	$D > 840$	22 (PT); 25 (ES)	33
		$330 \leq D \leq 630$	31,5	36
		Height of the flange (S_h)	$630 \leq D \leq 760$	29,5
	$D > 760$		27,5	36
Face of the flange (q_R)	$D \geq 330$	6,5	-	

These limit values shall be taken as design values and shall be stated as in-service limit values in the maintenance file described in section 4.5.

 OTIF	Uniform Technical Prescription (UTP)			UTP WAG
	ROLLING STOCK - FREIGHT WAGONS			Page 23 of 148
Status: DRAFT	Version 1	TECH-23020	Original: EN	Date: 17.5.2023

Fig. 2 Symbols for wheels used in table 4



The mechanical characteristics of the wheels shall ensure the transmission of forces and torque as well as the resistance against thermal load where so required in accordance with the area of use.

The demonstration of conformity is described in point 6.1.2.3.

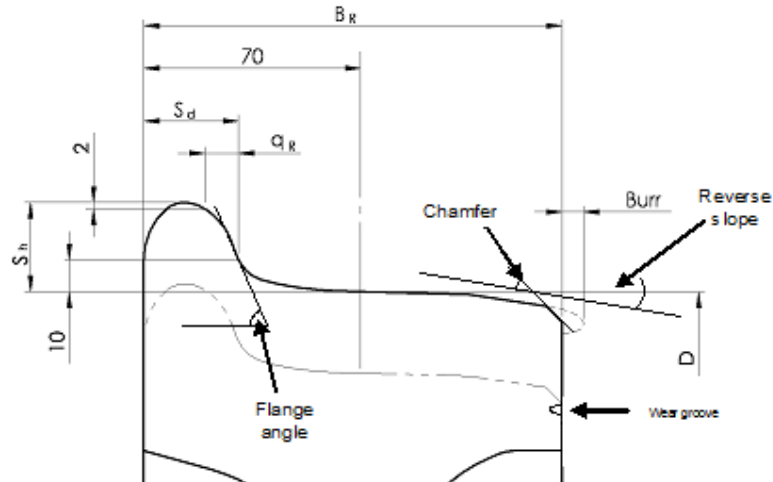
4.2.3.6.4 Characteristics of axles

The characteristics of the axle shall ensure the transmission of forces and torque in accordance with the area of use.

The demonstration of conformity is described in point 6.1.2.4.

The traceability of axles shall take into account the findings of the ERA Task Force on Freight Maintenance (see “Final report on the activities of the Task Force Freight Wagon Maintenance”

, version 1.0 of 5 October 2010,

published on the ERA website <http://www.era.europa.eu>).

4.2.3.6.5 Axle boxes / bearings

The axle box and the rolling bearing shall be designed with consideration of mechanical resistance and fatigue characteristics. Temperature limits reached in service relevant for the hot box detection shall be defined.

The demonstration of conformity is described in point 6.2.2.4.

4.2.3.6.6 Automatic variable gauge systems

This requirement is applicable to units equipped with an automatic variable gauge system with changeover mechanism of the axial position of the wheels allowing the unit to be compatible with 1435 mm track gauge and other track gauge(s) within the scope of this UTP by means of passage through a track gauge changeover facility.

The changeover mechanism shall ensure the locking in the correct intended axial position of the wheel.

 OTIF	Uniform Technical Prescription (UTP)			UTP WAG
	ROLLING STOCK - FREIGHT WAGONS			Page 24 of 148
Status: DRAFT	Version 1	TECH-23020	Original: EN	Date: 17.5.2023

After passage through the track gauge changeover facility, the verification of the state of the locking system (locked or unlocked) and of the position of the wheels shall be performed by one or more of the following means: visual control, on-board control system or infrastructure/facility control system. In case of on-board control system, continuous monitoring shall be possible.

If running gear is equipped with brake equipment subject to a change in position during the gauge change operation, the automatic variable gauge system shall ensure the position and safe locking in the correct position of this equipment simultaneously to those of the wheels.

The failure of the locking of the position of the wheels and braking equipment (if relevant) during operation has typical credible potential to lead directly to a catastrophic accident (resulting in multiple fatalities); considering this severity of the failure consequence, it shall be demonstrated that the risk is controlled to an acceptable level.

The automatic variable gauge system is defined as an interoperability constituent (point 5.3.4b) and is part of the interoperability constituent wheelset (point 5.3.2). The conformity assessment procedure is specified in point 6.1.2.6 (interoperability constituent level), point 6.1.2.2 (safety requirement) and in point 6.2.2.4a (subsystem level).

The track gauges the unit is compatible with shall be recorded in the technical documentation.

A description of the changeover operation in normal mode, including the type(s) of track gauge changeover facility(ies) the unit is compatible with, shall be part of the technical documentation (see also section 4.4).

The requirements and conformity assessments required in other sections of this UTP apply independently for each wheel position corresponding to one track gauge and have to be documented accordingly.

4.2.3.6.7 *Running gear for manual change of wheelsets*

The requirement is applicable to units prepared to run on different track gauges, by means of a physical change of wheelset.

The unit shall be equipped with a locking mechanism in order to ensure the correct position of its brake equipment in the different configurations considering the dynamic effects in accordance with the design operating state of the unit.

The demonstration of conformity is described in point 6.2.2.5.

4.2.4 **Brake**

4.2.4.1 General

The purpose of the train brake system is to ensure that

- the train's speed can be reduced,
- the train's speed can be maintained on a slope
- the train can be stopped within the maximum allowable braking distance and that
- the train can be immobilised.

Primary factors that influence the braking performance and the braking process are

- the braking power,
- the train mass,

 OTIF	Uniform Technical Prescription (UTP)			UTP WAG
	ROLLING STOCK - FREIGHT WAGONS			Page 25 of 148
Status: DRAFT	Version 1	TECH-23020	Original: EN	Date: 17.5.2023

- the speed,
- the allowable braking distance,
- the available adhesion and
- the track gradient.

The brake performance of a train is derived from the individual brake performance of each unit in the train.

4.2.4.2 Safety requirements

The braking system contributes to the safety level of the railway system. Therefore, the design of the braking system of a unit has to undergo a risk assessment in accordance with

UTP GEN-G Risk Evaluation and Assessment, | Commission Implementing Regulation (EU) No 402/2013¹⁶

considering the hazard of complete loss of the brake capability of the unit. The severity level shall be deemed as catastrophic when

- it affects the unit alone (combination of failures) or,
- it affects the brake capability of more than the unit (single fault).

The fulfilment of the conditions of C.9 and C.14 of Appendix C is presumed to be in conformity with this requirement.¹⁷

4.2.4.3 Functional and technical requirements

4.2.4.3.1 General functional requirements

The brake equipment of the unit shall provide the functions of braking such as the application and the release of the brake, upon a transmitted signal. The brake shall be

- continuous (the brake application or release signal is transmitted from a central command to the whole train by a control line),
- automatic (an inadvertent disruption of the control line shall lead to brake activation on all units of the train bringing each part to stand still),
- disengageable, which enables its release and isolation.

4.2.4.3.2 Brake performance

4.2.4.3.2.1 Service brake

The brake performance of a train or a unit is its ability to decelerate. It is the result of the braking power available to decelerate the train or unit within defined limits and all factors involved in the conversion and dissipation of energy including train resistance.

¹⁶ ~~OJ L 121, 3.5.2013, p. 8.~~ [As amended by Commission Implementing Regulation \(EU\) 2015/1136 of 13 July 2015.](#)

¹⁷ For this reason, no specific risk evaluation and assessment are required when the technical solutions of C.9 and C.14 of Appendix C are used.

 OTIF	Uniform Technical Prescription (UTP)			UTP WAG
	ROLLING STOCK - FREIGHT WAGONS			Page 26 of 148
Status: DRAFT	Version 1	TECH-23020	Original: EN	Date: 17.5.2023

The brake performance of a unit shall be calculated in accordance with one of the [specifications referenced in Appendix D, either Index \[16\], Index \[37\], Index \[58\] or Index \[17\]](#). ~~following documents:~~

~~— EN 14531-6:2009 or~~

~~— UIC 544-1:2014.~~

The calculation shall be validated by tests. Brake performance calculation in accordance with [the specification referenced in Appendix D Index \[17\]](#) shall be validated as set out in the same specification or in the specification referenced in Appendix D, Index [58]. ~~UIC 544-1:2014 shall be validated as set out in UIC 544-1:2014.~~

4.2.4.3.2.2 Parking brake

A Parking Brake is a brake used to prevent parked rolling stock moving under the specified conditions taking into account the place, wind, gradient and rolling stock loading state, until intentionally released.

If the unit is equipped with a parking brake, the following requirements shall be met:

- the immobilisation shall remain until intentionally released.
- where it is not possible to identify the state of the parking brake directly, an indicator showing the state shall be provided on both sides on the outside of the vehicle.
- the minimum parking brake force, considering no wind, shall be determined by calculations as defined in ~~clause 6 of EN 14531-6:2009~~ [the specification referenced in Appendix D Index \[16\]](#).
- ~~— the parking brake of a unit shall be designed considering a wheel/rail (steel/steel) adhesion factor not higher than 0,12.~~

[Where relevant, the calculations shall determine:](#)

- [the minimum parking brake force for an unloaded wagon,](#)
- [the maximum parking brake force for a fully loaded wagon,](#)
- [the breakover loading mass, i.e. the minimum loading condition for the maximum parking brake force,](#)
- [the parking brake of a unit shall be designed considering a wheel/rail \(steel/steel\) adhesion factor not higher than 0,12.](#)

4.2.4.3.3 Thermal capacity

The brake equipment shall be able to withstand one emergency brake application without any loss of brake performance due to thermal or mechanical effects.

The thermal load, the unit is capable to withstand without any adverse loss of brake performance due to thermal or mechanical effects, shall be defined and expressed in terms of speed, axle load, gradient and brake distance.

The demonstration of conformity is described in point 6.2.2.6.

A slope of 21 ‰ at 70 km/h during 40 km may be considered as the reference case for the thermal capacity which results in a braking power of 45 kW per wheel during 34 minutes for a nominal wheel diameter of 920 mm and an axle load of 22.5 t.

 OTIF	Uniform Technical Prescription (UTP) ROLLING STOCK - FREIGHT WAGONS			UTP WAG Page 27 of 148
	Status: DRAFT	Version 1	TECH-23020	Original: EN Date: 17.5.2023

4.2.4.3.4 *Wheel slide protection (WSP)*

Wheel slide protection (WSP) is a system designed to use the maximum available adhesion by decreasing, holding or increasing the brake force to prevent wheel sets from locking and uncontrolled sliding. Thereby the stopping distance shall be optimized

If an electronic WSP-control is used negative effects caused by malfunctions of WSP shall be reduced by suitable system design processes and technical configuration.

The WSP shall not alter the functional characteristics of the brakes. The vehicle's air equipment shall be dimensioned such that the air consumption of the WSP does not impair the performance of the pneumatic brake. The design process of the WSP shall take into account that the WSP has no detrimental effect on the constituent parts of the vehicle (brake gear, wheel tread, axle boxes, etc.).

The following types of units shall be fitted with WSP:

- types of units equipped with all types of brake block except composite brake blocks, for which the maximum mean utilisation of adhesion is greater than 0,12.
- types of units equipped with disc brakes only and/or with composite brake blocks, for which the maximum mean utilisation of adhesion is greater than 0,11.

4.2.4.3.5 *Friction elements for wheel tread brakes*

The friction element for wheel tread brakes (i.e. brake block) generates brake forces by friction when engaged with the wheel tread.

If wheel tread brakes are used the characteristics of the friction element shall contribute reliably to achieving the intended brake performance.

The demonstration of conformity is described in point 6.1.2.5.

4.2.5 **Environmental conditions**

The design of the unit, as well as its constituents shall take into account the environmental conditions to which this rolling stock will be subjected to.

The environmental parameters are described in the clauses below. For each environmental parameter, a nominal range is defined, which is the most commonly encountered in Europe, and is the basis for the interoperable unit.

For certain environmental parameters ranges other than the nominal one are defined. In that case, a range shall be selected for the design of the unit.

For the functions identified in the clauses below, design and/or testing provisions taken to ensure that the rolling stock is meeting the requirements in this range shall be described in the technical file.

Depending on the ranges selected and on provisions taken (described in the technical file), appropriate operating rules could be necessary when the unit designed for the nominal range is operated on a particular line where the nominal range is exceeded at certain periods of the year.

The ranges, if different from the nominal one, to be selected to avoid any restrictive operating rule(s) linked to environmental conditions, are specified by the Contracting States and are listed in section 7.4.

The unit and its constituents shall be designed under consideration of one or several of the following temperature classes allocated to external air temperature ranges

- T1: -25°C to +40°C (nominal),

 OTIF	Uniform Technical Prescription (UTP)			UTP WAG
	ROLLING STOCK - FREIGHT WAGONS			Page 28 of 148
Status: DRAFT	Version 1	TECH-23020	Original: EN	Date: 17.5.2023

- T2: -40°C to +35°C and
- T3: -25°C to +45°C

The unit shall meet the requirements [of this UTP](#) without degradation for snow, ice and hail conditions as defined in ~~clause 4.7 of EN 50125-1:2014~~ [the specification referenced in Appendix D Index \[18\]](#), which correspond to the nominal range.

Where more severe ‘snow, ice and hail’ conditions than considered in the standard are selected, the unit and its constituents shall then be designed to meet requirements considering the combined effect with low temperature according to the temperature range chosen.

In relation with the temperature range T2 and with the severe conditions for snow, ice and hail, the provisions taken to meet requirements in these severe conditions shall be identified and verified, in particular design and/or testing provisions considering the following functions:

- Coupling function restricted to the resiliency of couplings.
- Brake function, including brake equipment.

The demonstration of conformity is described in point 6.2.2.7.

4.2.6 System protection

4.2.6.1 Fire safety

4.2.6.1.1 General

All significant potential fire sources (high risk components) on the unit shall be identified. The fire safety aspects of the unit design shall be aimed at

- preventing a fire from occurring,
- limiting the effects if a fire occurs.

The goods carried on the unit are not part of the unit and do not have to be taken into account in the conformity assessment.

4.2.6.1.2 Functional and technical specification

4.2.6.1.2.1 Barriers

In order to limit the effects of fire, fire barriers with integrity of at least 15 minutes shall be installed between the identified potential fire sources (high risk components) and the carried load.

The demonstration of conformity is described in point 6.2.2.8.1.

4.2.6.1.2.2 Materials

All permanent materials used on the unit shall have limited ignitability and flame spread properties, unless

- the material is separated from all potential fire risks on the unit by a fire barrier and the safe application is supported by a risk assessment or
- the component has a mass <400g, and is located within a horizontal distance of ≥ 40 mm and a vertical distance of ≥ 400 mm to other non-tested components.

The demonstration of conformity is described in point 6.2.2.8.2.

 OTIF	Uniform Technical Prescription (UTP)			UTP WAG
	ROLLING STOCK - FREIGHT WAGONS			Page 29 of 148
Status: DRAFT	Version 1	TECH-23020	Original: EN	Date: 17.5.2023

4.2.6.1.2.3 Cables

The selection and installation of electrical cables shall take into account their fire behaviour properties.

The demonstration of conformity is described in point 6.2.2.8.3.

4.2.6.1.2.4 Flammable liquids

The unit shall be provided with measures preventing a fire from occurring and spreading due to leakage of flammable liquids or gases.

The demonstration of conformity is described in point 6.2.2.8.4.

4.2.6.2 Protection against electrical hazards

4.2.6.2.1 Protective measures against indirect contact (protective bonding)

The impedance between vehicle body and the running rail shall be low enough to prevent hazardous voltages between them.

Units shall be bonded in accordance with the provisions as described in ~~clause 6.4 of EN 50153:2014~~[the specification referenced in Appendix D Index \[27\]](#).

4.2.6.2.2 Protective measures against direct contact

The electrical installations and equipment of a unit shall be designed so as to protect persons from electric shock.

The unit shall be designed so that direct contact is prevented following the provisions set out in ~~clause 5 of EN 50153:2014~~[the specification referenced in Appendix D Index \[27\]](#).

4.2.6.3 Attachment devices for rear-end signal

On all units designed to receive a rear-end signal, two devices at the end of the unit shall provide for the installation of two lamps or two reflective plates as set out in Appendix E on the same height above rail not higher than 2000 mm.

The dimensions and clearance of these attachment devices shall be as described in ~~Figure 11 of EN 16116-2:2013~~[the specification referenced in Appendix D Index \[28\]](#).

4.3 Functional and technical specification of the interfaces

The following sections contain tables 5, 6 and 7, with a three-column layout. The left and middle columns are part of this UTP.

The substance in the middle column also appears in the equivalent EU TSI, although the title of the middle column has been adapted.

 OTIF	Uniform Technical Prescription (UTP)		UTP WAG	
	ROLLING STOCK - FREIGHT WAGONS		Page 30 of 148	
Status: DRAFT	Version 1	TECH-23020	Original: EN	Date: 17.5.2023

4.3.1 Interface with the subsystem “infrastructure”

Table 5 Interface with infrastructure subsystem

Reference to the OTHF or national regulations	Reference in this UTP	Reference Commission Decision 2011/275/EU
<p>There are no infrastructure requirements in OTHF regulations.</p> <p>In accordance with ATMF Article 6 §2, it is the responsibility of the rail transport undertaking to ensure the compatibility of the vehicle with the infrastructure it is operated on.</p> <p>The track design and layout are the responsibility of the Contracting State.</p>	4.2.3.1 — Gauging	4.2.4.1 — Minimum structure gauge 4.2.4.2 — Distance between track centres 4.2.4.5 — Minimum radius of vertical curve
	4.2.3.2 — Compatibility with load-carrying capacity of lines	4.2.7.1 — Track resistance to vertical loads 4.2.7.3 — Lateral track resistance 4.2.8.1 — Resistance of bridges to traffic loads 4.2.8.2 — Equivalent vertical loading for earthworks and earth pressure effects 4.2.8.4 — Resistance of existing bridges and earthworks to traffic loads
	4.2.3.5.2 — Running dynamic behaviour	4.2.9 — Track geometrical quality
	4.2.3.6.2 — Characteristics of wheelsets	4.2.5.1 — Nominal track gauge
	4.2.3.6.3 — Characteristics of wheels	4.2.5.6 — Rail head profile for plain line 4.2.6.2 — In service geometry of switches and crossings

<u>Reference in UTP WAG</u>	<u>Reference in UTP INF¹⁸</u>
4.2.3.1 Gauging	4.2.3.1 Structure gauge

¹⁸ The references to the INF TSI [add new reference] are set out in Table 5 of the WAG TSI [add new reference].

 OTIF	Uniform Technical Prescription (UTP)			UTP WAG
	ROLLING STOCK - FREIGHT WAGONS			Page 31 of 148
Status: DRAFT	Version 1	TECH-23020	Original: EN	Date: 17.5.2023

<u>Reference in UTP WAG</u>	<u>Reference in UTP INF¹⁸</u>
	4.2.3.2 Distance between track centres 4.2.3.5 Minimum radius of vertical curve
4.2.3.2 Compatibility with load carrying capacity of lines	4.2.6.1 Track resistance to vertical loads 4.2.6.3 Lateral track resistance 4.2.7.1 Resistance of new bridges to traffic loads 4.2.7.2 Equivalent vertical loading for new earthworks and earth pressure effects 4.2.7.4 Resistance of existing bridges and earthworks to traffic loads
4.2.3.5.2 Running dynamic behaviour	4.2.8 Immediate action limits
4.2.3.6.2 Characteristics of wheelsets 4.2.3.6.3 Characteristics of wheels	4.2.4.1 Nominal track gauge 4.2.4.6 Railhead profile for plain line 4.2.5.1 Design geometry of switches and crossings

 OTIF	Uniform Technical Prescription (UTP)			UTP WAG
	ROLLING STOCK - FREIGHT WAGONS			Page 32 of 148
Status: DRAFT	Version 1	TECH-23020	Original: EN	Date: 17.5.2023

4.3.2 Interface with the subsystem “operation and traffic management”

Table 6 Interface with operation and traffic management subsystem

Reference to the OTIF or national regulations	Reference in this -UTP <u>WAG</u>	Reference <u>in UTP TCRC¹⁹ Commission Decision 2011/314/EU</u>
COTIF does not define contingency arrangements; national contingency arrangements apply. The requirements in section 4.2.2.2 are deemed compatible with all national contingency measures.	4.2.2.2 Strength of unit - Lifting and jacking	= 4.2.3.6.3 Contingency arrangements
In accordance with ATMF Article 6 §2, it is the responsibility of the rail transport undertaking to ensure the compatibility of the vehicle with the infrastructure it is operated on.	4.2.3.1 Gauging	4.2.2.5.2. <u>Route compatibility</u> 3. _____ T train composition
	4.2.3.2 Compatibility with load carrying capacity of lines	4.2.2.5.2. <u>Route compatibility</u> 3. _____ T train composition
	4.2.4 Brake	4.2.2.6 Train braking
	4.2.6.3 Attachment devices for rear-end signal. Appendix E Rear-end signal	= 4.2.2.1.3.2 Rear-end

¹⁹ The references to the OPE TSI [\[add new reference\]](#) are set out in Table 6 of the WAG TSI [\[add new reference\]](#).

 OTIF	Uniform Technical Prescription (UTP)			UTP WAG
	ROLLING STOCK - FREIGHT WAGONS			Page 33 of 148
Status: DRAFT	Version 1	TECH-23020	Original: EN	Date: 17.5.2023

4.3.3 Interface with the subsystem “control, command and signalling”

Table 7 Interface with control, command and signalling subsystem

Reference to the OTH or national regulations	Reference in this UTP WAG	Reference in Appendix D.2 Index [A] of this UTP²⁰ ERA/ERTMS/033281 rev. 4.0
<p>The interfaces for compatibility with train detection systems are set out in Appendix HD.2 Index [A] of this UTP.</p>	4.2.3.3 a) Rolling stock characteristics compatible with train detection system based on track circuits	<ul style="list-style-type: none"> — Index [A.1]: train detection system based on track circuits axle distances (3.1.2.1, 3.1.2.4, 3.1.2.5 and 3.1.2.6); — vehicle axle loads (3.1.7.1) — impedance between wheels (3.1.9); — use of composite brake blocks (3.1.6);
	4.2.3.3 b) Rolling stock characteristics compatible with train detection system based on axle counters	<ul style="list-style-type: none"> — Index [A.2]: train detection system based on axle counters axle distances (3.1.2.1, 3.1.2.2, 3.1.2.5 and 3.1.2.6); — wheel geometry (3.1.3.1–3.1.3.4); — metal / inductive components-free space between wheels (3.1.3.5) — wheel material (3.1.3.6).
	4.2.3.3 c) Rolling stock characteristics compatible with train detection system based on loop equipment	<ul style="list-style-type: none"> — Index [A.3]: train detection system based on loop equipment vehicle metal construction (3.1.7.2).

4.4 Operating rules

The rail transport undertaking shall control the risks associated with the use of the wagon. Operating rules covering the activities and measures set out in Appendix I shall be established²¹.

Operating rules are developed within the procedures described in the railway undertaking safety management system.

²⁰ The references to the CCS TSI [add new reference] are set out in Table 7 of the WAG TSI [add new reference].

²¹ COTIF does not specify who should establish these operating rules.

 OTIF	Uniform Technical Prescription (UTP)			UTP WAG
	ROLLING STOCK - FREIGHT WAGONS			Page 34 of 148
Status: DRAFT	Version 1	TECH-23020	Original: EN	Date: 17.5.2023

These rules take into account the documentation related to operation which forms a part of the technical file as required in

UTP GEN-C, General Provisions – Technical File. | Article 15(4) of and as set out in Annex IV to Directive (EU) 2016/797.

For the safety critical components (see also 4.5), the specific operational and operational traceability requirements are developed by the designers/manufacturers at design phase and through collaboration between designers/manufacturers and the railway undertakings concerned or the wagon keeper concerned after vehicles have entered into operation.

The documentation related to operation describes the characteristics of the unit in relation to the design operating state to be considered in order to define the operating rules in normal and in various reasonably foreseeable degraded modes.

The documentation related to operation is composed of:

- a description of operation in normal mode, including the operational characteristics and limitations of the unit (e.g. vehicle gauge, maximum design speed, axle loads, brake performance, compatibility with train detection systems, permitted environmental conditions, type(s) and operation of track gauge changeover facility(ies) the unit is compatible with),
- a description of operation in degraded mode (when equipment or functions described in this UTP suffer safety failures) as far as can reasonably predicted, together with the related acceptable limits and operating conditions of the unit that could be experienced,
- a safety critical components list: the safety critical components list shall contain the specific operational and operational traceability requirements.

The applicant shall provide the initial version of the documentation related to operating rules. This documentation might be modified later in accordance with the corresponding

Rules | Union legislation,
 taking into account the existing operating and maintenance conditions of the unit. ~~The~~
~~Assessing Entity~~ | ~~Notified Body~~
~~shall verify only that the documentation on operation is provided.~~

4.5 Maintenance rules

Maintenance is a set of activities intended to keep a functional unit in, or to restore it to a state in which it can perform its required function.

The following documents being part of the technical file as required in

UTP GEN-C, General Provisions – Technical File | Article 15(4) of and as set out in Annex IV to Directive (EU) 2016/797

are necessary to undertake maintenance activities on the units:

- general documentation (point 4.5.1)
- the maintenance design justification file (point 4.5.2) and
- the maintenance description file (point 4.5.3).

 OTIF	Uniform Technical Prescription (UTP)			UTP WAG
	ROLLING STOCK - FREIGHT WAGONS			Page 35 of 148
Status: DRAFT	Version 1	TECH-23020	Original: EN	Date: 17.5.2023

The applicant shall provide the three documents described in 4.5.1, 4.5.2 and 4.5.3. This documentation might be modified later in accordance with the corresponding

OTIF regulations, | EU legislation,
taking into account the existing operating and maintenance conditions of the unit. ~~The~~
~~Assessing Entity~~ | ~~Notified Body~~
~~shall verify only that the documentation on maintenance is provided.~~

The keeper | The applicant or any entity authorised by the
applicant (e.g. a keeper)

shall provide this documentation to the entity in charge of maintenance as soon as it is assigned for the maintenance of the unit.

On the basis of these three documents, the entity in charge of maintenance shall define a maintenance plan and appropriate maintenance requirements at maintenance operational level under its sole responsibility (not in the scope of the assessment against this UTP).

The documentation includes a list of safety critical components. Safety critical components are components for which a single failure has a credible potential to lead directly to

a serious accident. | a serious accident as defined in Article 3(12) of
Directive (EU) 2016/798.

The safety critical components and their specific servicing, maintenance and maintenance traceability requirements are identified by the designers/manufacturers at design phase and through collaboration between designers/manufacturers and the entities in charge of maintenance concerned, after vehicles have entered into operation.

4.5.1 General documentation

The general documentation comprises ~~of~~:

- Drawings and description of the unit and its components.
- Any legal requirement concerning the maintenance of the unit.
- Drawing of systems (electrical, pneumatic, hydraulic and control-circuit diagrams).
- Additional on-board systems (description of the systems including description of functionality, specification of interfaces and data processing and protocols).
- Configuration files for each vehicle (parts list and bill of material) to enable (in particular but not only) traceability during maintenance activities.

4.5.2 Maintenance design justification file

The maintenance design justification file explains how maintenance activities are defined and designed in order to ensure that the rolling stock characteristics will be kept within permissible limits of use during its lifetime. The file shall give input data in order to determine the criteria for inspection and the periodicity of maintenance activities. The maintenance design justification file ~~consists of~~ comprises:

- Precedents, principles and methods used to design the maintenance of the unit.

 OTIF	Uniform Technical Prescription (UTP)			UTP WAG
	ROLLING STOCK - FREIGHT WAGONS			Page 36 of 148
Status: DRAFT	Version 1	TECH-23020	Original: EN	Date: 17.5.2023

- Precedents, principles and methods used to identify the safety critical components and their specific operational, servicing, maintenance and traceability requirements.
- Limits of the normal use of the unit (e.g. km/month, climatic limits, foreseen types of loads etc.).
- Relevant data used to design the maintenance and origin of these data (return of experience).
- Tests, investigations and calculations carried out to design the maintenance.

4.5.3 Maintenance description file

The maintenance description file describes how maintenance activities can be conducted. Maintenance activities include, among others, inspections, monitoring, tests, measurements, replacements, adjustments and repairs.

Maintenance activities are split into:

- preventive maintenance (scheduled and controlled), and
- corrective maintenance.

The maintenance description file includes the following:

- Component hierarchy and functional description which sets up the boundaries of the rolling stock by listing all the items belonging to the product structure of that rolling stock and using an appropriate number of discrete levels. The lowest item of the hierarchy shall be a replaceable component.
- Parts list which shall contain the technical and functional descriptions of the spare parts (replaceable units). The list shall include all parts specified for changing based on condition, which may require a replacement following electrical or mechanical malfunction or for which replacement is foreseeable following accidental damage. Interoperability constituents shall be indicated and referenced to their corresponding declaration of conformity.
- Safety critical components list: The safety critical components list shall contain the specific servicing, maintenance and servicing/maintenance traceability requirements.
- Limit values for components which are not to be exceeded in service. It is permitted to specify operational restrictions in degraded mode (limit value reached).
- List of reference to the
 - | European
 - legal obligations to which components or subsystems are subject.
- Maintenance plan²² i.e. the structured set of tasks to perform the maintenance including the activities, procedures and means. The description of this set of tasks includes:
 - (a) Disassembly/assembly instructions drawings necessary for correct assembly/disassembly of replaceable parts.
 - (b) Maintenance criteria.

²² The maintenance plan shall take into account the findings of the ERA Task Force on Freight Maintenance (see “Final report on the activities of the Task Force Freight Wagon Maintenance” published on the ERA website <http://era.europa.eu>)

 OTIF	Uniform Technical Prescription (UTP)			UTP WAG
	ROLLING STOCK - FREIGHT WAGONS			Page 37 of 148
Status: DRAFT	Version 1	TECH-23020	Original: EN	Date: 17.5.2023

- (c) Checks and tests in particular of safety relevant parts; these include visual inspection and non-destructive tests (where appropriate e.g. to detect deficiencies that may impair safety).
 - (d) Tools and materials required to undertake the task.
 - (e) Consumables required to undertake the task.
 - (f) Personal protective safety provision and equipment.
- Necessary tests and procedures to be undertaken after each maintenance operation before re-entry into service of rolling stock.

4.6 Professional competencies

The professional competencies of staff required for

the operational activities relating to train composition and the use of wagons within their limits and conditions of use are set out in section 4.4 Operating Rules of this UTP.²³

the operation and maintenance of units are not covered by this TSI.

4.7 Health and safety conditions

The provisions for health and safety of staff required for the operation and maintenance of units are covered by the essential requirements 1.1.5, 1.3.1, 1.3.2, 2.5.1, 2.6.1 set out in

UTP General Provisions - Essential requirements (UTP GEN-A).

Annex III to Directive (EU) 2016/797.

In particular, the following points of section 4.2 specify provisions for health and safety of staff:

Point 4.2.2.1.1: End coupling

Point 4.2.6.1: Fire safety

Point 4.2.6.2: Protection against electrical hazards. If the unit is fitted with a manual coupling system, a free space for shunters during coupling and uncoupling shall be provided.

All protruding parts deemed a hazard to operational staff shall be clearly indicated and/or fitted with protective devices.

The unit shall be equipped with footsteps and handrails except in those cases it is not intended to be operated with staff on-board, e.g. for shunting.

4.8 Parameters to be recorded in the technical file²⁴

The technical file shall contain at least the following parameters:

- Type, position and resiliency of the end coupling

²³ Professional competencies of staff required for the maintenance of units are ~~not covered by this UTP, because they are covered by Annex A to the ATMF UR, concerning the regulation for the certification of Entities~~ in Charge of Maintenance.

²⁴ The full title of the section in the WAG TSI ~~in accordance with Commission Regulation (EU) No 1236/2013~~ is "4.8 Parameters to be recorded in the technical file and European register of authorised types of vehicles".

 OTIF	Uniform Technical Prescription (UTP)			UTP WAG
	ROLLING STOCK - FREIGHT WAGONS			Page 38 of 148
Status: DRAFT	Version 1	TECH-23020	Original: EN	Date: 17.5.2023

- Load due to dynamic traction forces and compressive forces
- Gauge reference profiles to which the unit complies
- Conformity, if any, to target gauge reference profile(s) G1, GA, GB and GC
- Compliance, if any, to gauge lower reference profile(s) GI1 and GI2
- Mass per axle (tare and fully laden)
- Position of the axles along the unit and number of axles
- Length of the unit
- Maximum design speed Track gauges(s) the unit can be operated on
- Compatibility with train detection systems (track circuits / axle counters / loop equipment) which shall include the data required in section 4.2.3.3 of this UTP
- Compatibility with hot axle box detection systems
- In-service temperature range of the axle bearings
- Nature of the signal which controls the brake (example: pneumatic main brake pipe, electric brake type XXX, ...)
- Characteristics of the control line and of its coupling with other units (main brake pipe diameter, section of the electric cable ...)
- Individual nominal performance of the brake unit, depending on the brake mode, if any (response time, brake force, level of adhesion required, ...)
- Braking distance or brake weight depending on the brake mode, if any
- Thermal load of the brake components expressed in terms of speed, axle load, gradient and brake distance
- Temperature range and severity level of snow/ice/hail conditions
- ~~Brake weight and maximum gradient of the parking brake (if applicable)~~
- Ability / inability to be hump shunted
- Presence of footsteps and/or handrails
- Minimum brake force and, where relevant, maximum brake force and breakover loading mass for the parking brake (if applicable)
- Number of axles where the parking brake is applied
- Presence of one or more of the following functions: DDF, DPF, DDAF
- Description of the signal informing of a derailment or a precursor to a derailment and its transmission for units fitted with DDF or DPF.

The rolling stock data that must be recorded in the “European register of authorized types of vehicles (ERATV)” are set out in the Commission Implementing Decision

 OTIF	Uniform Technical Prescription (UTP)			UTP WAG
	ROLLING STOCK - FREIGHT WAGONS			Page 39 of 148
Status: DRAFT	Version 1	TECH-23020	Original: EN	Date: 17.5.2023

2011/665/EU of 4 October 2011 on the European register of authorized types of railway vehicles.²⁵

4.9 Route compatibility checks before the use of vehicles

Railway undertakings shall [apply the UTP TCRC when using freight wagons in the scope of this UTP WAG](#). ~~check all relevant parameters of freights wagons to ensure compatibility with the route on which they intend to use the freight wagons.~~

~~The parameters shall be those set out in the UTP covering route compatibility checks.~~

~~In the absence of UTP provisions, Contracting States should facilitate route compatibility checks by railway undertakings, e.g. by providing the relevant parameters.~~

~~These checks shall comply with the provisions laid down in ATMF, in particular those of Article 6 § 2, Article 9 and Article 15a.~~

The parameters of the subsystem “rolling stock — freight wagons” to be used by the railway undertaking, for the purpose of route compatibility check, are described in Appendix D1 of Commission Implementing Regulation (EU) 2019/773²⁶

5. INTEROPERABILITY CONSTITUENTS

5.1 General

Interoperability Constituents, also referred to as “Elements of Construction”, or “ICs”, as defined in Article 2(g) of [the ATMF UR](#), ~~Appendix G to the Convention~~,

are listed in section 5.3 together with

- their area of use covering parameters of the subsystem and
- the reference to corresponding requirements defined in section 4.2.

Depending on the law applicable in the state concerned, ICs shall be assessed separately or, if no such requirement for separate assessment exists in the state concerned, the IC may alternatively be assessed as part of the subsystem.

Interoperability constituents (ICs), as defined in article 2(7) of Directive (EU) 2016/797,

²⁵ ~~OJ L 264, 8.10.2011, p.32.~~

²⁶ Commission Implementing Regulation (EU) 2019/773 of 16 May 2019, [as last amended by \[add new reference\]](#) on the technical specification for interoperability relating to the operation and traffic management subsystem of the rail system within the European Union, ~~and repealing Decision 2012/757/EU (OJ L 139 I, 27.5.2019, p. 5).~~

 OTIF	Uniform Technical Prescription (UTP)		UTP WAG	
	ROLLING STOCK - FREIGHT WAGONS		Page 40 of 148	
Status: DRAFT	Version 1	TECH-23020	Original: EN	Date: 17.5.2023

ICs assessed separately shall, as a general rule, be covered by a declaration of conformity or suitability for use by the manufacturer. Time limited exceptions to the obligation of issuing such a declaration for rear-end signals and for brake blocks are indicated below.

Rear-end signals newly manufactured up to 1 January 2015 are not required to be covered by a declaration of conformity or suitability for use by the manufacturer.

Notwithstanding the provisions in section 6.3, the following transitional provisions apply to Elements of Construction corresponding to a “friction element for wheel tread brakes” (further referred to in this paragraph as brake block) which are assessed separately from the subsystem:

brake blocks which are not covered by a declaration of conformity or suitability for use by the manufacturer may be used on new, renewed or upgraded wagons if the type of brake block has already been used on a wagon which was admitted to international traffic in accordance with the UTPs, or authorised in at least one Member State of the EU, either before 1.7.2015, or before the expiry of the brake block’s approval period under the following conditions:

- If the brake block was manufactured before 1.7.2015, it may be used until 30.6.2025.
- If the brake block was manufactured from 1.7.2015 onwards and its approval period had not expired when it was produced, it may be used up to 10 years after the expiry of its approval period.

The production, upgrade or renewal of the wagon shall be completed, including its admission to

(27)

After a transition period ending on 1 January 2015, newly produced interoperability constituents of “rear-end signal”, shall be covered by the required EC declaration of conformity.

Article 8a²⁸

1. Notwithstanding the provisions in Section 6.3 of the Annex, an EC certificate of verification may be issued for a subsystem containing components corresponding to the “friction element for wheel tread brakes” interoperability constituent that does not have an EC declaration of conformity during a transition period ending on 1 January 2024, if the following conditions are met:

- a) the component was manufactured before the date of application of this Regulation; and*
- b) the interoperability constituent has been used in a subsystem that had been approved and placed on the market in at least one Member State before the date of application of this Regulation.*

2. The production, upgrade or renewal of any subsystem using non-certified interoperability constituents shall be completed, including granting authorisation for placing on the market, before the transition period set out in paragraph 1 expires.

Article 8c

1. Notwithstanding the provisions in Section 6.3 of the Annex, an EC certificate of verification may be issued for a subsystem containing

²⁷ [The text in italics in point 5.1 is quoted from Commission Regulation \(EU\) No 321/2013 of 13 March 2013, as last amended by \[add new reference\] -concerning the technical specification for interoperability relating to the subsystem ‘rolling stock – freight wagons’. Article 8\(4\) of Commission Regulation \(EU\) No 1236/2013 amending the WAG TSI as last amended by Commission Implementing Regulation \(EU\) 2019/776 of 16 May 2019](#)

²⁸ ~~Articles 8a and 8c of Commission Regulation 2015/924 amending the WAG TSI as last amended by Commission Implementing Regulation (EU) 2019/776 of 16 May 2019~~

 OTIF	Uniform Technical Prescription (UTP)		UTP WAG	
	ROLLING STOCK - FREIGHT WAGONS		Page 41 of 148	
Status: DRAFT	Version 1	TECH-23020	Original: EN	Date: 17.5.2023

international traffic, before these transitional periods expire.

components corresponding to the “friction element for wheel tread brakes” interoperability constituent that does not have an EC declaration of conformity during a transition period of 10 years after the expiry of the approval period of the interoperability constituent, if the following conditions are met:

- a) the component was manufactured before the expiry of the approval period of the interoperability constituent; and*
- b) the interoperability constituent has been used in a subsystem that had been approved and placed on the market in at least one Member State before the expiry of its approval period.*

2. The production, upgrade or renewal of any subsystem using non-certified interoperability constituents shall be completed, including granting authorisation for placing on the market, before the transition period set out in paragraph 1 expires.

3. During the transition period set out in paragraph 1:

(a) the reasons for non-certification of any interoperability constituents shall be properly identified in the verification procedure for the subsystem referred to in paragraph 1; and

(b) the national safety authorities shall report in their annual report, as referred to in Article 19 of Directive (EU) 2016/798, on the use of non-certified ‘friction element for wheel tread brakes’ interoperability constituents in the context of authorisation procedures

Article 8b

Until the expiry of their current approval period, the brake blocks referred to in Appendix G are deemed to comply with this UTP.

1. Until the expiry of their current approval period, “friction element for wheel tread brakes” interoperability constituents listed in Appendix G of the Annex do not need to be covered by an EC declaration of conformity. During this period, “friction elements for wheel tread brakes” listed in Appendix G of the Annex shall be deemed to be compliant with this Regulation.

2. After their current approval period expires, “friction element for wheel tread brakes” interoperability constituents listed in Appendix G

 OTIF	Uniform Technical Prescription (UTP)			UTP WAG
	ROLLING STOCK - FREIGHT WAGONS			Page 42 of 148
Status: DRAFT	Version 1	TECH-23020	Original: EN	Date: 17.5.2023

of the Annex shall be covered by EC declaration of conformity.

Article 9a

~~If a type or design of “friction element for wheel tread brakes” is assessed separately from the subsystem in accordance with this UTP, the corresponding type or design examination certificate shall be valid for 10 years. During that period, new components of the same type or design may be used in a unit on the basis of a declaration of conformity that refers to this type or design examination certificate.~~

~~The EC type or EC design examination certificate for the “friction element for wheel tread brakes” interoperability constituent shall be valid for 10 years. During that period, new constituents of the same type may be placed on the market on the basis of an EC declaration of conformity that refers to this EC type or EC design examination certificate.~~

ICs shall comply with the technical specifications of this chapter whether it is assessed separately as an IC or it is assessed as an integrated part of a subsystem.

Assessment of ICs separate from the subsystem is not mandatory in the COTIF regulations, but Contracting States or regional organisations²⁹ may require mandatory separate assessment according to the specification in sections 5.3 and 6.1.2 of this UTP.

Separate assessment of an IC:

If the IC is in conformity with this UTP, as evidenced by the manufacturer in the form of a declaration of conformity or suitability for use according to section 6.1.2 of this UTP and chapter 2 of UTP GEN-D, the IC shall be permitted to be used in accordance with its defined area of use, in accordance with section 5.3, in all Contracting States.

Assessment of an IC integrated into a vehicle:

If the IC is assessed as a part of the subsystem, the assessment procedures for subsystems apply. The requirements are identical to those if the IC were to be assessed separately, i.e. those set out in sections 5.3 and 6.1.2.

When a requirement is identified in section 5.3 as being assessed at IC level, an assessment for the same requirement at subsystem level is not required.

²⁹ In particular, compliance with EU law must be ensured when placing an IC on the market in the European Union.

 OTIF	Uniform Technical Prescription (UTP)			UTP WAG
	ROLLING STOCK - FREIGHT WAGONS			Page 43 of 148
Status: DRAFT	Version 1	TECH-23020	Original: EN	Date: 17.5.2023

5.2 Innovative solutions

As stated in

Sections 6.2.3 of this UTP | Article 10a³⁰,

innovative solutions may require new specifications and/or new assessment methods. Such specifications and assessment methods shall be developed using the process described in point 6.2.3 whenever an innovative solution is envisaged for an IC.

5.3 IC specifications

5.3.1 Running gear

The running gear shall be designed for all application ranges, the areas of use, as defined by the following parameters:

- Track gauge
- Maximum speed
- Maximum cant deficiency
- Minimum tare of the unit
- Maximum axle load
- Range of distances between bogie pivots or range of wheelbase of “two-axle units”
- Maximum height of centre of gravity of empty unit
- Coefficient of height of centre of gravity of loaded unit minimum torsional stiffness coefficient of car body
- Maximum mass distribution coefficient for empty units with:

$$\frac{1}{2a^*} \cdot \sqrt{\frac{I_{zz}}{m}}$$

I_{zz} moment of inertia of the car body relative to the vertical axis through the centre of gravity of the car body

m mass of the car body

$2a^*$ wheelbase

- Minimum nominal wheel diameter
- Rail inclination

The parameters speed and axle load may be considered in combination in order to define the appropriate area of use (e.g. maximum speed and tare weight).

³⁰ Article 10a of ~~the Commission Regulation (EU) No 321/2013 of 13 March 2013, as last amended by [add reference...]~~ [concerning the technical specification for interoperability relating to the subsystem rolling stock – freight wagons](#), ~~Commission Regulation (EU) 2015/924 amending the WAG TSI as last amended by Commission Implementing Regulation (EU) 2019/776 of 16 May 2019~~

 OTIF	Uniform Technical Prescription (UTP)			UTP WAG
	ROLLING STOCK - FREIGHT WAGONS			Page 44 of 148
Status: DRAFT	Version 1	TECH-23020	Original: EN	Date: 17.5.2023

The running gear shall comply with the requirements expressed in points 4.2.3.5.2 and 4.2.3.6.1. These requirements shall be assessed at IC level.

5.3.2 Wheelset

For the purpose of this UTP, wheelsets include the main parts ensuring the mechanical interface with the track (wheels and connecting elements: e.g. transverse axle, independent wheel axle). Accessory parts (axle bearings, axle boxes and brake discs) are assessed at subsystem level.

The wheelset shall be assessed and designed for the area of use as defined by:

- track gauge,
- nominal wheel tread diameter and
- maximum vertical static force.

A wheelset shall comply with the requirements on geometrical and mechanical parameters defined in point 4.2.3.6.2. These requirements shall be assessed at IC level.

5.3.3 Wheel

A wheel shall be designed and assessed for an area of use defined by

- nominal tread diameter,
- maximum vertical static force,
- maximum speed,
- in-service limits, and
- maximum braking energy.

A wheel shall comply with the requirements on geometrical, mechanical and thermomechanical parameters defined in point 4.2.3.6.3. These requirements shall be assessed at IC level.

5.3.4 Axle

An axle shall be designed and assessed for an area of use defined by

- maximum vertical static force.

An axle shall comply with the requirements on mechanical parameters defined in point 4.2.3.6.4. These requirements shall be assessed at IC level.

5.3.4a. Friction elements for wheel tread brakes

Friction element for wheel tread brakes. The friction element for wheel tread brakes shall be designed and assessed for an area of use defined by:

- dynamic friction coefficients and their tolerance bands,
- minimum static friction coefficient,
- maximum permitted brake forces applied on the element,
- suitability for train detection by systems based on track circuits,
- suitability for severe environmental conditions.

 OTIF	Uniform Technical Prescription (UTP)			UTP WAG
	ROLLING STOCK - FREIGHT WAGONS			Page 45 of 148
Status: DRAFT	Version 1	TECH-23020	Original: EN	Date: 17.5.2023

A friction element for wheel tread brakes shall comply with the requirements defined in point 4.2.4.3.5. These requirements shall be assessed at IC level.

5.3.4b. Automatic variable gauge system

An IC “automatic variable gauge system” shall be designed and assessed for an area of use defined by:

- the track gauges the system is designed for,
- the range of maximum static axle loads,
- the range of nominal wheel tread diameters,
- the maximum design speed of the unit, and
- the types of track gauge changeover facility(ies) the system is designed for, including the nominal speed through the track changeover facility(ies) and the maximum axial forces during the automatic gauge changeover process.

An automatic variable gauge system shall comply with the requirements set out in point 4.2.3.6.6; these requirements shall be assessed at IC level as set out in point 6.1.2.6.

5.3.5 Rear-end signal

The rear-end signal, as described in Appendix E, is an independent IC. There are no requirements in section 4.2 dealing with the rear-end signal.

Its assessment by the notified body is not part of the EC verification of the subsystem.

6. CONFORMITY ASSESSMENT AND VERIFICATION

6.1 Interoperability constituent (IC)

6.1.1 Modules

The conformity assessment of an IC shall be performed in accordance with the module(s) described in table 8.

Table 8 Assessment procedures for ICs

Module CA1	Internal production control plus product verification by individual examination
Module CA2	Internal production control plus product verification at random intervals
Module CB	Type examination
Module CD	Conformity to type based on quality management system of the production process
Module CF	Conformity to type based on product verification

 OTIF	Uniform Technical Prescription (UTP)			UTP WAG
	ROLLING STOCK - FREIGHT WAGONS			Page 46 of 148
Status: DRAFT	Version 1	TECH-23020	Original: EN	Date: 17.5.2023

Module CH	Conformity based on full quality management system
Module CH1	Conformity based on full quality management system plus design examination
Module CV	Type validation by in-service experience (suitability for use)

These modules are specified in detail in

UTP GEN-D General Provisions – Assessment Procedures (Modules).

the Commission Decision 2010/713/EU.

6.1.2 Conformity Assessment procedures

In accordance with UTP GEN-D, Contracting States may require ~~the mandatory separate assessment of~~ that ICs be assessed for conformity as isolated products, in a procedure that is separate from the assessment of the subsystem.

~~If Contracting States may also permit the assessment of ICs as part of the subsystem, without requiring a separate procedure for ICs. not required by the Contracting State, If this integrated assessment is permitted, applicants may still chose to assess ICs separately.~~ assessment of ICs may be carried out on a voluntary basis.

In case of conformity assessment of an IC as part of the subsystem, the compliance of the IC with the applicable provisions is verified by applying the modules for subsystem in accordance with section 6.2 of this UTP.

ICs for which module CV applies shall be assessed separately from the subsystem.

In the case of separate IC assessment, the manufacturer bears full responsibility for the UTP compliance of the IC product within its specified area of use.

In the case of separate IC assessment, the manufacturer shall

The manufacturer or his authorised representative established within the Union shall

choose one of the modules or module combinations indicated in table 9 in accordance with the required IC.

 OTIF	Uniform Technical Prescription (UTP)			UTP WAG
	ROLLING STOCK - FREIGHT WAGONS			Page 47 of 148
Status: DRAFT	Version 1	TECH-23020	Original: EN	Date: 17.5.2023

Table 9 Assessment procedures for the verification of ICs

Point	Constituent	Modules					
		CA1 or CA2	CB+CD	CB+CF	CH	CH1	CV
4.2.3.6.1	Running gear		X	X		X	
	Running gear - established	X			X		
4.2.3.6.2	Wheelset	X ^(*)	X	X	X ^(*)	X	
4.2.3.6.3	Wheel	X ^(*)	X	X	X ^(*)	X	
4.2.3.6.4	Axle	X ^(*)	X	X	X ^(*)	X	
4.2.3.6.6	Automatic variable gauge system	X ^(*)	X	X	X ^(*)	X	X ^(**)
4.2.4.3.5	Friction elements for wheel tread brakes	X ^(*)	X	X	X ^(*)	X	X ^(**)
5.3.5	Rear-end signal	X			X		

(*) Modules CA1, CA2 or CH may be used only in the case of products placed on the market, and therefore developed, before

1 January 2014,

the entry into force of this TSI,

provided that the manufacturer demonstrates to the assessing entity that design review and type examination were performed for previous applications under comparable conditions, and are in conformity with the requirements of this UTP; this demonstration shall be documented, and is considered as providing the same level of proof as module CB or design examination according to module CH1.

(**) Module CV shall be used in case the manufacturer of friction element for wheel tread brakes has no sufficient return of experience (according to its own judgment) for the proposed design.

Within the application of the chosen module or module combination the interoperability constituent shall be assessed against the requirements mentioned in section 4.2. If necessary, additional requirements concerning the assessment of particular interoperability constituents are given in the following clauses.

For a specific case applicable to a component defined as an interoperability constituent in section 5.3, the corresponding requirement can be part of the verification at interoperability constituent level only if the component remains compliant with chapters 4 and 5 and where the specific case does not refer to a national technical requirement.

a national rule (i.e. additional requirement compatible with the core TSI and fully specified in the TSI).

 OTIF	Uniform Technical Prescription (UTP)			UTP WAG
	ROLLING STOCK - FREIGHT WAGONS			Page 48 of 148
Status: DRAFT	Version 1	TECH-23020	Original: EN	Date: 17.5.2023

In other cases, the verification shall be made at subsystem level; when a national rule applies to a component, the Contracting State concerned may define relevant applicable conformity assessment procedures.

6.1.2.1 Running gear

The demonstration of conformity for running dynamic behaviour is set out in ~~EN 16235:2013~~ the specification referenced in Appendix D Index [8].

Units equipped with an established running gear as described in ~~chapter 6 of EN 16235:2013~~ that specification are presumed to be in conformity with the relevant requirement provided that the running gears are operated within their established area of use.

The minimum axle load and maximum axle load during operation of a wagon equipped with an established running gear shall be compliant with the loading conditions between tare and loaded masses specified for the established running gear, as in the specification referenced in Appendix D Index [8].

If the minimum axle load is not achieved by the mass of the vehicle in tare condition, conditions for use can be applied to the wagon requiring that it always be operated with a minimum payload or a ballast (for example with an empty loading device) in order to comply with the parameters of the specification referenced in Appendix D Index [8].

In such case, the parameter 'Mass of wagon in tare conditions' may be substituted by 'Minimum axle load' in the justification for not carrying out on-track tests with established running gear. This shall be reported in the Technical File as a condition for use.

The assessment of the bogie frame strength shall be based on ~~clause 6.2 of EN 13749:2011~~ the specification referenced in Appendix D Index [9].

6.1.2.2 Wheelset

The demonstration of conformity for the mechanical behaviour of the wheelset assembly shall be carried out ~~according to clause 3.2.1 of EN13260:2009+A1:2010~~ in accordance with the specification referenced in Appendix D Index [10], which defines limit values for the axial assembly force and the associated verification test.

~~Alternative demonstration of conformity is allowed in accordance with point 6.1.2.4a.~~

~~A verification procedure shall exist to ensure at the assembly phase that no defects may detrimentally affect safety due to any change in the mechanical characteristics of the fitted parts of the axle. This procedure shall contain the determination of the interference values and, in case of press-fitted wheelsets, the corresponding press-fitting diagram.~~

6.1.2.3 Wheel

- (a) Forged and rolled wheels: The mechanical characteristics shall be proven following the procedure ~~as specified in clause 7 of EN 13979-1:2003+A1:2009+A2:2011~~ described in the specification referenced in Appendix D Index [11].

If the wheel is intended to be used with brake blocks acting on the wheel running surface, the wheel shall be thermo-mechanically proven by taking into account the maximum braking energy foreseen. A type test, as described in ~~clause 6.2 of EN 13979-1:2003+A1:2009+A2:2011~~ the specification referenced in Appendix D Index [11], shall be

 OTIF	Uniform Technical Prescription (UTP)			UTP WAG
	ROLLING STOCK - FREIGHT WAGONS			Page 49 of 148
Status: DRAFT	Version 1	TECH-23020	Original: EN	Date: 17.5.2023

performed in order to check that the lateral displacement of the rim during braking and the residual stress are within the specified tolerance limits.

The decision criteria of residual stresses for forged and rolled wheels are set out in ~~EN 13979-1:2003+A1:2009+A2:2011~~ [the same specification](#).

Alternative demonstration of conformity is allowed in accordance with point 6.1.2.4a.

- (b) Other types of wheels: Other types of wheels are permitted for units in national use. In that case the decision criteria and the fatigue stress criteria shall be specified in

national technical requirements. Such national technical requirements may only be applied to international traffic when they are in force in accordance with Article 12 of [the APTU UR, Appendix F to the Convention](#).

national rules. Those national rules shall be notified by Member States in accordance with Article 14 of Directive (EU) 2016/797.

A verification procedure shall exist to ensure at the production phase that no defects may detrimentally affect safety due to any change in the mechanical characteristics of the wheels. The tensile strength of the material in the wheel, the hardness in the rim, the fracture toughness (only for tread-braked wheels), resistance to impact, the material characteristics and the material cleanliness shall be verified. The verification procedure shall specify the batch sampling used for each characteristic to be verified.

6.1.2.4 Axle

In addition to the requirement ~~on~~ [for](#) the assembly above, the demonstration of conformity of [the](#) mechanical resistance and fatigue characteristics of the axle shall be based on ~~clauses 4, 5 and 6 of EN 13103:2009+A2:2012~~ [the specification referenced in Appendix D, Index \[12\]](#).

[That specification includes](#) the decision criteria for the permissible stress ~~are specified in clause 7 of EN 13103:2009+A2:2012~~. A verification procedure shall exist to ensure at the production phase that no defects may ~~detrimentally~~ [adversely](#) affect safety due to any change in the mechanical characteristics of the axles. The tensile strength of the material in the axle, the resistance to impact, the surface integrity, the material characteristics and the material cleanliness shall be verified. The verification procedure shall specify the batch sampling used for each characteristic to be verified.

Alternative demonstration of conformity is allowed in accordance with point 6.1.2.4a.

6.1.2.4a Alternative assessment procedure applicable to wheelsets, wheels and axles

~~Where the EN standards referred to in points 6.1.2.2, 6.1.2.3 and 6.1.2.4 do not cover the proposed technical solution, it is permitted to use other standards to demonstrate conformity of the mechanical behaviour of the wheelset assembly, the mechanical characteristics of the wheels and the mechanical resistance and fatigue characteristics of the axle respectively; in that case the assessing entity shall verify that the alternative standards form part of a technically consistent set of standards applicable to the design, construction and testing of the~~

~~Where the EN standards referred to in points 6.1.2.2, 6.1.2.3 and 6.1.2.4 do not cover the proposed technical solution, it is permitted to use other standards to demonstrate conformity of the mechanical behaviour of the wheelset assembly, the mechanical characteristics of the wheels and the mechanical resistance and fatigue characteristics of the axle respectively; in that case the notified body shall verify that the alternative standards form part of a technically consistent set of standards applicable to the design, construction and testing of the wheelsets;~~

 OTIF	Uniform Technical Prescription (UTP)			UTP WAG
	ROLLING STOCK - FREIGHT WAGONS			Page 50 of 148
Status: DRAFT	Version 1	TECH-23020	Original: EN	Date: 17.5.2023

~~wheelsets, containing specific requirements for wheelset, wheels and axles covering:~~

- ~~— wheelset assembly,~~
- ~~— mechanical resistance,~~
- ~~— fatigue characteristics,~~
- ~~— permissible stress limits,~~
- ~~— thermomechanical characteristics.~~

~~Only standards that are publicly available can be referred to in the demonstration required above. The verification carried out by the assessing entity shall ensure the consistency between the methodology of the alternative standards, the assumptions taken by the applicant, the intended technical solution and the intended area of use.~~

~~containing specific requirements for wheelset, wheels and axles covering:~~

- ~~— wheelset assembly,~~
- ~~— mechanical resistance,~~
- ~~— fatigue characteristics,~~
- ~~— permissible stress limits,~~
- ~~— thermomechanical characteristics.~~

~~Only standards that are publicly available can be referred to in the demonstration required above. The verification carried out by the notified body shall ensure the consistency between the methodology of the alternative standards, the assumptions taken by the applicant, the intended technical solution and the intended area of use.~~

Where the EN standards referred to in points 6.1.2.2, 6.1.2.3 and 6.1.2.4 do not cover the proposed technical solution, it is permitted to use other standards to demonstrate conformity of the mechanical behaviour of the wheelset assembly, the mechanical characteristics of the wheels and the mechanical resistance and fatigue characteristics of the axle respectively; in that case, the assessing entity shall verify that the alternative standards form part of a technically consistent set of standards applicable to the design, construction and testing of the wheelsets, containing specific requirements for wheelset, wheels and axles covering:

- wheelset assembly,
- mechanical resistance,
- fatigue characteristics,
- permissible stress limits,
- thermomechanical characteristics.

Only standards that are publicly available can be referred to in the demonstration required above. The verification carried out by the assessing entity shall ensure the consistency between the methodology of the alternative standards, the assumptions taken by the applicant, the intended technical solution and the intended area of use.

6.1.2.5 Friction elements for wheel tread brakes

The demonstration of conformity of friction elements for wheel tread brakes shall be carried out by determining the following friction element properties in accordance with

Appendix O:

the European Railway Agency (ERA) technical document ERA/TD/2013-02/INT version 3.0 of 27.11.2015 published on the ERA website (<http://www.era.europa.eu>):

- dynamic friction performance (chapter 4);
- static friction coefficient (chapter 5);

 OTIF	Uniform Technical Prescription (UTP)			UTP WAG
	ROLLING STOCK - FREIGHT WAGONS			Page 51 of 148
Status: DRAFT	Version 1	TECH-23020	Original: EN	Date: 17.5.2023

- mechanical characteristics including properties in respect to shear strength test and flexural strength test (chapter 6).

Demonstration of the following suitabilities shall be carried out in accordance with chapters 7 and/or 8 of

Appendix O,

the ERA technical document ERA/TD/2013-02/INT version 3.0 of 27.11.2015 published on the ERA website (<http://www.era.europa.eu>),

if the friction element is intended to be suitable for:

- train detection by systems based on track circuits; and/or
- severe environmental conditions.

If a manufacturer does not have sufficient return of experience (according with its own judgement) for the proposed design, the type validation by in-service experience procedure (module CV) shall be part of the assessment procedure for suitability for use. Before commencing in-service tests, a suitable module (CB or CH1) shall be used to certify the design of the interoperability constituent.

The in-service tests shall be organised on request from the manufacturer, who must obtain agreement from a railway undertaking that will contribute to such an assessment.

The suitability for train detection by systems based on track circuits for friction elements intended to be used in subsystems beyond the scope set out in chapters 7 of

Appendix O,

the ERA technical document ERA/TD/2013-02/INT version 3.0 of 27.11.2015 published on the ERA website (<http://www.era.europa.eu>),

may be demonstrated using the procedure for innovative solutions described in point 6.1.3.

The suitability for severe environmental conditions by a dynamometer test for friction elements intended to be used in subsystems beyond the scope set out in clause 8.2.1 of

Appendix O,

the ERA technical document ERA/TD/2013-02/INT version 3.0 of 27.11.2015 published on the ERA website (<http://www.era.europa.eu>),

may be demonstrated using the procedure for innovative solutions described in point 6.1.3.

Despite a positive assessment in accordance with chapter 8 of Appendix O, friction elements for wheel tread brakes may require particular operational measures to be implemented in order to ensure their safe use under severe Nordic winter conditions ³¹.

6.1.2.6 Automatic variable gauge system

The assessment procedure shall be based on a validation plan covering all aspects mentioned in points 4.2.3.6.6 and 5.3.4b.

³¹ The European Commission and the EU Agency for railways are investigating the subject at EU level, which may lead to further recommendations. See <https://ec.europa.eu/transparency/regdoc/rep/10102/2020/EN/SWD-2020-240-F1-EN-MAIN-PART-1.PDF>

 OTIF	Uniform Technical Prescription (UTP)			UTP WAG
	ROLLING STOCK - FREIGHT WAGONS			Page 52 of 148
Status: DRAFT	Version 1	TECH-23020	Original: EN	Date: 17.5.2023

The validation plan shall be consistent with the safety analysis required in point 4.2.3.6.6 and shall define the assessment needed in all the following different phases:

- Design review
- Static tests (bench tests and integration-in-the-wheelset/unit tests)
- Test on track gauge changeover facility(ies), representative of in-service conditions
- On-track tests, representative of in-service conditions.

Regarding the demonstration of compliance to the safety level required in point 4.2.3.6.6, the assumptions considered for the safety analysis related to the unit the system is intended to be integrated in, and related to the mission profile of that unit, shall be clearly documented.

The automatic variable gauge system may be subject to an assessment of suitability for use (module CV). Before commencing in-service tests, a suitable module (CB or CH1) shall be used to certify the design of the interoperability constituent. The in-service tests shall be organised on request from the manufacturer, who must obtain an agreement from a railway undertaking for its contribution to such assessment.

The certificate issued by the assessing entity in charge of the conformity assessment shall include both the conditions for use as per point 5.3.4b and the type(s) and operating conditions of the track gauge changeover facility(ies) the automatic variable gauge system has been assessed for.

6.1.3 Innovative solutions

If an innovative solution referred to in

Point 6.2.3

| Article 10a

is proposed for an interoperability constituent, the manufacturer or his authorised representative

| established within the Union

shall apply

mutatis mutandis the procedure set out in point 6.2.3.

| the procedure set out in Article 10a.

6.2 Subsystem

6.2.1 Modules

For requirements applicable to the functional subsystems³², conformity with the requirement shall be ensured during operation. Assessment of the functional parts is not included in the tasks of the [Assessing e](#)Entity. The

The EC

verification of the subsystem “Rolling stock – freight wagons” shall be performed in accordance with the module(s) described in table 10.

³² This UTP contains requirements applicable to two functional subsystems in accordance with UTP GEN-B; the first being Operation and traffic management, the second being maintenance. The requirements related to the [functiona](#) subsystem concern (part of the) sections 4.2.3.6.4, 4.3.2, 4.4, 4.5.1, 4.6 and UTP Marking, which apply to the use of freight wagons.

 OTIF	Uniform Technical Prescription (UTP)			UTP WAG
	ROLLING STOCK - FREIGHT WAGONS			Page 53 of 148
Status: DRAFT	Version 1	TECH-23020	Original: EN	Date: 17.5.2023

Table 10 Assessment procedures for the verification of subsystems

(OTIF) Type examination	SB	EC-Type Examination
Quality management system of the production process	SD	EC verification based on quality management system of the production process
Verification based of product verification	SF	EC verification based on product verification
Verification based on full quality management system plus design examination	SH1	EC verification based on full quality management system plus design examination

These modules are specified in detail in

~~APTU Uniform Rules, Appendix F to COTIF 1999-~~ the Decision 2010/713/EU.
UTP GEN-D.

6.2.2 Verification procedures

The applicant shall choose one of the following combinations of modules or module for the
| EC

verification of the subsystem.

- (SB+SD) or
- (SB+SF) or
- (SH1).

Within the application of the chosen module or module combination the subsystem shall be assessed against the requirements mentioned in section 4.2. If necessary, additional requirements concerning the assessment of particular constituents are given in the following clauses.

6.2.2.1 Strength of unit

The demonstration of conformity shall be in accordance with ~~chapters 6 and 7 of EN 12663-2:2010, or alternatively with chapter 9.2 of EN 12663-1:2010+A1:2014~~ [one of the specifications referenced in Appendix D, either Index \[3\] or Index \[1\]](#).

Regarding joints, a recognised verification procedure shall exist to ensure at the production phase that no defect may decrease the intended mechanical characteristics of the structure.

6.2.2.2 Safety against derailment running on twisted track

The demonstration of conformity shall be carried out in accordance with ~~chapters 4, 5 and 6.1 of EN 14363:2016~~ [the specification referenced in Appendix D Index \[7\]](#).

 OTIF	Uniform Technical Prescription (UTP)			UTP WAG
	ROLLING STOCK - FREIGHT WAGONS			Page 54 of 148
Status: DRAFT	Version 1	TECH-23020	Original: EN	Date: 17.5.2023

6.2.2.3 Running dynamic behaviour

On-track tests

The demonstration of conformity shall be carried out in accordance with ~~chapters 4, 5 and 7 of EN 14363:2016~~ [the specification referenced in Appendix D Index \[7\]](#).

For units operated on the 1668 mm track gauge network, the evaluation of the estimated value for the guiding force normalized to the radius $R_m = 350$ m ~~in accordance to EN 14363:2016, clause 7.6.3.2.6 (2) with that specification,~~ shall be calculated ~~in accordance to~~ [with the following formula:](#)

$$Y_{a,nf,qst} = Y_{a,f,qst} - (11\,550 \text{ m} / R_m - 33) \text{ kN.}$$

The limit value of the quasi-static guiding force $Y_{j,a,qst}$ shall be 66 kN.

Values of cant deficiency can be adapted to 1668 mm track gauge by multiplying the corresponding 1435 mm parameter values by the following conversion factor: 1 733/1 500.

The combination of the highest equivalent conicity and speed for which the unit meets the stability criterion in ~~chapters 4, 5 and 7 of EN 14363:2016~~ [the specification referenced in Appendix D Index \[7\]](#) shall be recorded in the report.

6.2.2.4 Axle box / bearings

The demonstration of conformity for mechanical resistance and fatigue characteristics of the rolling bearing shall be in accordance with ~~clause 6 of EN 12082:2007+A1:2010~~ [the specification referenced in Appendix D Index \[13\]](#).

It is permitted to use other standards for the above demonstration of conformity where the EN standards do not cover the proposed technical solution; in that case the assessing entity shall verify that the alternative standards form part of a technically consistent set of standards applicable to the design, construction and testing of the bearings.

Only standards that are publicly available can be referred to in the demonstration required above.

In the case of bearings manufactured according to a design developed and already used

| to place products on the market

before the entry into force of relevant UTPs applicable to those products, the applicant is allowed to deviate from the demonstration of conformity above and refer to design review and type examination performed for previous applications under comparable conditions instead; this demonstration shall be documented and is considered to provide the same level of proof as type examination according to module SB or design examination according to module SH1.

6.2.2.4a. Automatic variable gauge systems

The safety analysis required in point 4.2.3.6.6, and performed at IC level, shall be consolidated at the level of the unit; in particular, the assumptions made in accordance with point 6.1.2.6 may need to be reviewed to take into account the unit and its mission profile.

 OTIF	Uniform Technical Prescription (UTP)			UTP WAG
	ROLLING STOCK - FREIGHT WAGONS			Page 55 of 148
Status: DRAFT	Version 1	TECH-23020	Original: EN	Date: 17.5.2023

6.2.2.5 Running gear for manual change of wheelsets

Changeover between 1435 mm and 1668 mm track gauges

The technical solutions described in the ~~following figures of the UIC leaflet 430-1:2012~~ [specification referenced in Appendix D Index \[14\]](#) for axle units and for bogie units are deemed to be compliant with the requirements in point 4.2.3.6.7:

- ~~— for axle units: figures 9 and 10 of Annex B.4, and figure 18 of Annex H of UIC leaflet 430-1:2012,~~
- ~~— for bogie units: figure 18 of Annex H and figures 19 and 20 of Annex I of UIC leaflet 430-1:2012.~~

Changeover between 1435 mm and 1524 mm track gauges

The technical solution described in ~~Appendix 7 of UIC leaflet 430-3:1995~~ [the specification referenced in Appendix D Index \[15\]](#) is deemed to be compliant with the requirements in point 4.2.3.6.7.

6.2.2.6 Thermal capacity

Calculations, simulations or tests shall demonstrate that the temperature of the brake block, brake pad or brake disc does not exceed their thermal capacity. The following shall be taken into account:

- (a) Concerning the emergency brake application: the critical combination of speed and payload considering straight and level track, minimum wind and dry rails
- (b) Concerning the continuous brake application:
 - the range up to the maximum braking power,
 - the range up to the maximum speed and
 - the corresponding brake application time.

6.2.2.7 Environmental conditions

Steel materials are deemed to comply with all the ranges indicated in point 4.2.5 if the material properties are determined down to -20°C.

6.2.2.8 Fire safety

6.2.2.8.1 Barriers

Barriers shall be tested in accordance with ~~EN1363-1:2012. Steel sheets of at least 2 mm thickness and aluminium sheets of at least 5 mm thickness are deemed to comply with the integrity requirements without testing~~ [the specification referenced in Appendix D Index \[19\]](#).

6.2.2.8.2 Materials

Testing of the materials ignitability and flame spread properties shall be performed in accordance with ~~ISO 5658-2:2006/Am1:2011~~ [the specification referenced in Appendix D Index \[20\]](#) for which the limit value shall be $CFE \geq 18 \text{ kW/m}^2$.

For rubber parts of bogies, the testing shall be performed in accordance with ~~ISO 5660-1:2015~~ [the specification referenced in Appendix D Index \[23\]](#) for which the limit value shall be

 OTIF	Uniform Technical Prescription (UTP)			UTP WAG
	ROLLING STOCK - FREIGHT WAGONS			Page 56 of 148
Status: DRAFT	Version 1	TECH-23020	Original: EN	Date: 17.5.2023

MARHE ≤ 90 kW/m² under the test conditions ~~specified in reference T03.02 of Table 6 of EN 45545-2:2013+A1:2015~~ set out in the specification referenced in Appendix D Index [22].

For the following materials and components, the fire safety requirements are deemed to comply with the required ignitability and flame spread properties:

- Wheelsets, coated or uncoated.
- Metals and alloys with inorganic coatings (such as, but not limited to: galvanized coating, anodic coating, chromate film, phosphate conversion coating).
- Metals and alloys with an organic coating with a nominal thickness less than 0.3 mm (such as, but not limited to paints, plastic coating, asphaltic coating).
- Metals and alloys with a combined inorganic and organic coating of which the nominal thickness of the organic layer is less than 0.3 mm.
- Glass, stoneware, ceramic and natural stone products.
- Materials that meet the requirements of category C-s₃, d₂ or higher in accordance with ~~EN 13501-1:2007+A1:2009~~ the specification referenced in Appendix D Index [21].

6.2.2.8.3 Cables

The electrical cables shall be selected and installed in accordance with ~~EN 50355:2013 and EN 50343:2014~~ the specification referenced in Appendix D Indexes [24] and [25].

6.2.2.8.4 Flammable liquids

The measures taken shall be in accordance with ~~EN 45545-7:2013~~ the specification referenced in Appendix D Index [26].

6.2.3 Innovative solutions

If an innovative solution

referred to in Article 10a

is proposed for the “Rolling stock – freight wagons” subsystem, the applicant shall apply the procedure set out

below:

in Article 10a³³

In order to keep pace with technological progress, innovative solutions may be required that do not comply with the specifications set out in this UTP or for which the assessment methods set out in this UTP cannot be applied. In that case, new specifications and/or new assessment methods associated with those innovative solutions shall be developed.

³³ Article 10a of Commission Regulation (EU) No 321/2013 of 13 March 2013, as last amended by [\[add reference...\]](#) concerning the technical specification for interoperability relating to the subsystem rolling stock – freight wagons, of the Commission Regulation (EU) 2015/924 amending the WAG TSI as last amended by Commission Implementing Regulation (EU) 2019/776 of 16 May 2019

 OTIF	Uniform Technical Prescription (UTP)			UTP WAG
	ROLLING STOCK - FREIGHT WAGONS			Page 57 of 148
Status: DRAFT	Version 1	TECH-23020	Original: EN	Date: 17.5.2023

Innovative solutions may be related to the “rolling stock — freight wagons” subsystem, its parts and its elements of construction.

If an innovative solution is proposed, the manufacturer or his authorised representative shall declare how it intends to deviate from or complement the relevant provisions of this UTP. On the basis of this declaration, one of the entities listed in Article 6 § 2 of [the APTU UR](#), or the Secretary General may submit the new specifications and/or new assessment methods to the Committee of Technical Experts (CTE) for analysis and approval.

If the CTE supports the new specifications and/or new assessment methods, the appropriate functional and interface specifications, which must be included in the UTP in order to allow the use of this innovative solution, shall be developed and subsequently integrated in the UTP during its revision process.

Pending the revision of the UTP, the ~~Committee of Technical Experts~~ CTEs may already consider the new specifications and/or new assessment methods as an acceptable means of compliance with the essential requirements of UTP GEN-A. In such case the ~~Committee of Technical Experts~~ CTE shall instruct the Secretary General as to how the new specifications and/or new assessment methods shall be communicated to the Contracting States and be made public.

6.3 Subsystem containing components corresponding to an interoperability constituent not holding an EC declaration

[reserved]

A Notified Body is permitted to issue an EC certificate of verification of a subsystem, even if one or more of the components corresponding to interoperability constituents incorporated within the subsystem are not covered by a relevant EC declaration of conformity in accordance with this TSI (non-certified ICs) if the constituent was manufactured before the entry into force of this TSI and the type of constituent has been

- used in a subsystem already approved, and
- placed in service in at least one

Member State before the entry in force of this TSI.

The EC verification of the subsystem shall be carried out by the Notified Body against the

 OTIF	Uniform Technical Prescription (UTP)			UTP WAG
	ROLLING STOCK - FREIGHT WAGONS			Page 58 of 148
Status: DRAFT	Version 1	TECH-23020	Original: EN	Date: 17.5.2023

requirements of Chapter 4 by using the corresponding requirements concerning assessment in Chapter 6 together with Chapter 7 except for specific cases. For this verification the modules of the subsystem, set out in point 6.2.2, apply.

EC declarations of conformity or suitability for use shall not be drawn up for the components assessed in this manner.

6.4 Project phases where assessment is required

The assessment shall cover the following two phases as identified by “X” in the table F.1 of Appendix F. In particular, where a type test is identified the conditions and requirements of section 4.2 shall be considered.

- (a) Design and development phase:
 - Design review and/or design examination
 - Type test: test to verify the design, if and as defined in the section 4.2.
- (b) Production phase:
 - Routine test to verify the conformity of production. The entity in charge of the assessment of the routine tests is determined according to the assessment module chosen.

Appendix F is structured according to section 4.2. Where relevant, a reference to the points of sections 6.1 and 6.2 is given.

6.5 ICs holding a declaration of conformity

Where an element
has been identified as an IC and held
either

- a declaration of conformity issued in accordance with a previous version of the UTP Wagons, or
- an EC declaration of conformity issued in accordance with EU regulations equivalent to a previous version of the UTP Wagons,

Where a constituent

an EC declaration of conformity

before the entry into force of this UTP, its treatment under this UTP is set out as follows:

- (a) In the case this constituent is not recognised as an IC in this UTP neither the certificate nor the declaration are valid for the verification procedure related to this UTP.
- (b) The

 OTIF	Uniform Technical Prescription (UTP)			UTP WAG
	ROLLING STOCK - FREIGHT WAGONS			Page 59 of 148
Status: DRAFT	Version 1	TECH-23020	Original: EN	Date: 17.5.2023

certificates issued in accordance with a previous version of the UTP WAG, or the equivalent

EC certificates of conformity, EC-type examination certificates and EC-design examination certificates of the following ICs shall remain valid under this UTP until their expiry:

- Wheelset;
- Wheel;
- Axle.

7. IMPLEMENTATION

7.1 Admission to operation³⁴

~~7.1 Admission to operation~~

~~Authorisation for placing on the market~~

(1) This UTP is applicable to the subsystem “rolling stock - freight wagons” within the scope set out in its ~~sections~~ points 1.1, 1.2 and 2.1, which

are admitted for use in international traffic after the entry into force of this UTP.

are placed on the market after the date of application of this TSI, except where point 7.1.1 ‘Application to ongoing projects’ applies.

(2) This UTP is also applicable on a voluntary basis to:

- units referred to in ~~section~~ point 2.1 ~~point~~ (a) in ~~transport (running mode) configuration~~, in case they correspond to a ‘unit’ as defined in this UTP, and
- units as defined in ~~section~~ point 2.1 ~~point~~ (c), in case they are in empty configuration.

In case the applicant chooses to apply this UTP, the corresponding UTP declaration of verification shall be recognised as such by Contracting States.

(3) Rolling stock that is in compliance with the UTP WAG 2021 or the UTP WAG 2022 is deemed also to comply with this UTP, with the exception of the elements listed in Appendix A.

Compliance with this Annex³⁵ in its version applicable before [Publications Office: please insert the date of entry into force of this amending act] is deemed equivalent to compliance with this TSI, except for changes listed in Appendix A.

³⁴ The title in the TSI reads: “Authorisation for placing on the market”.

³⁵ The Annex to Commission Regulation (EU) No 321/2013, as last amended by [add new reference] concerning the technical specification for interoperability relating to the subsystem ‘rolling stock — freight wagons’.

 OTIF	Uniform Technical Prescription (UTP)		UTP WAG	
	ROLLING STOCK - FREIGHT WAGONS		Page 60 of 148	
Status: DRAFT	Version 1	TECH-23020	Original: EN	Date: 17.5.2023

~~7.1.1 Admission to operation of a new vehicle in conformity with the previous WAG UTP~~

~~A UTP certificate of verification and a UTP declaration of verification of a vehicle³⁶ which is in conformity with the UTP WAG: 2012³⁷ shall be valid until the end of a transitional period ending on 1 January 2017.~~

~~ATMF Article 6 § 4 applies to wagons meeting the conditions prescribed in sections 4, 5 and 6 of this UTP, but not meeting the conditions of section 7.1.2.~~

~~Vehicles not subject to a specific case and meeting the conditions prescribed in section 7.1.2 meet the conditions of ATMF Article 3a § 2 and Article 6 § 3. Such a vehicle may circulate in international traffic in accordance with ATMF Article 6 § 3. Compatibility with the infrastructure shall be ensured by the rail transport undertaking under its responsibility in accordance with ATMF Article 6 § 2.~~

7.1.1 Application to ongoing projects

(1) Competent Authorities may issue a Certificate of Operation for a vehicle that has been assessed for conformity on the basis of a previous version of the UTP WAG, provided that it complies with phase A or phase B, as defined in points 7.2.3.1.1 and 7.2.3.1.2 of the previous version of UTP WAG.

(2) Without prejudice to Appendix A, Table A.2, the application of the requirements of Chapters 4, 5 and 6 to projects referred to in point (1) is possible on a voluntary basis.

(3) If the applicant chooses not to apply this UTP version to an ongoing project, the version of this UTP applicable at the beginning of phase A, as referred to in point (1), remains applicable.

Authorisation for placing in service of a new vehicle in conformity with the previous WAG TSIs

~~⁽³⁸⁾The declaration of verification and/or conformity to type of a new vehicle established in accordance with Decision 2006/861/EC shall be considered valid until the end of a transition period ending on 1 January 2017.~~

The application of this TSI applicable from [Publications Office: please insert the date of entry into force of this amending act] is not mandatory for projects that, on that date, are in phase A or phase B as defined in points 7.2.3.1.1 and 7.2.3.1.2 of the 'previous TSI' (i.e. this Regulation, as amended by Commission Implementing Regulation (EU) 2020/387

³⁶ The validity of certificates and declarations referred to in this paragraph is indicated for the purpose of delivery of admission to operation according to Article 6 of ATMF

³⁷ A 94-02/3.2011

³⁸ Article 9 of Commission Regulation (EU) No 321/2013 enacting the WAG TSI as last amended by Commission Implementing Regulation (EU) 2020/387 of 9 March 2020

 OTIF	Uniform Technical Prescription (UTP)			UTP WAG
	ROLLING STOCK - FREIGHT WAGONS			Page 61 of 148
Status: DRAFT	Version 1	TECH-23020	Original: EN	Date: 17.5.2023

7.1.2 [Mutual recognition of the first admission to operation](#)³⁹

~~7.1.3 Mutual recognition of the first admission to operation~~

The admission to operation of a vehicle which meets the conditions set out in section 7.1.2 of this UTP shall be valid in all Contracting States in accordance with Article 6 § 3 of ~~ATMF~~[the ATMF UR](#).

The conditions in this section shall be complementary to the requirements in section 4.2 and must be fulfilled in their entirety.

~~Mutual recognition of the first authorisation of placing on the market~~

In accordance with Article 21(3)(b) of Directive (EU) 2016/797 the authorisation for placing on the market of a vehicle (as defined in this TSI) is granted on the basis of:

- in accordance with point (a) of Article 21(3): the ‘EC’ declaration of verification as provided for in Article 15 of the same directive, and
- in accordance with (d) of Article 21(3): evidence of the technical compatibility of the unit with the network in the area of use covering the EU network.

Points (b) and (c) of Article 21(3) of Directive (EU) 2016/797 do not represent any additional requirement. The technical compatibility of the vehicle with the network being covered by rules (TSIs or national rules), this aspect is also considered at the level of the ‘EC’ verification.

Therefore, the conditions for having an area of use not limited to particular national networks are specified below as additional requirements to be covered in the EC verification of the subsystem rolling stock. These conditions shall be seen as complementary to the requirements in Section 4.2 and must be fulfilled in their entirety:

- a) The unit must be equipped with forged and rolled wheels assessed according to point 6.1.2.3 (a).
- b) The compliance/non-compliance with the requirements regarding the axle bearing condition monitoring by line side equipment as set out in point 7.3.2.2. (a) must be recorded in the technical file.
- c) The reference profile established for the unit as per point 4.2.3.1 must be allocated to one of the target reference profile(s) G1, GA, GB and GC including those used for the lower part GI1 and GI2.
- d) The unit must be compatible with the train detection systems based on track circuits, on axle counters and on loop equipment

where the values of the parameters set out in clauses 4.2.3.3(a), 4.2.3.3(b) and as specified in clauses 4.2.3.3(a) and 4.2.3.3(b) and 4.2.3.3(c).

³⁹ [The title in the TSI reads: “Mutual recognition of the first authorisation of placing on the market”.](#)

 OTIF	Uniform Technical Prescription (UTP)		UTP WAG	
	ROLLING STOCK - FREIGHT WAGONS		Page 62 of 148	
Status: DRAFT	Version 1	TECH-23020	Original: EN	Date: 17.5.2023

4.2.3.3(c) shall be as defined in Appendix ~~H~~D.2 Index [A] of this UTP.

d₁) If the unit has electronic equipment on board emitting interference current via the rail, the 'influencing unit' (as defined in the technical document referenced in Appendix D.2 Index [A]) of which the unit is planned to be part shall be compliant with

track circuits requirements captured in coordination with the authorities competent for the area of use of the unit

specific cases for track circuits notified under Article 13 of CCS TSI

by applying the harmonised vehicle test methods and vehicle impedance referred to in the technical document referenced in Appendix D.2 Index [A]. Compliance of the unit can be demonstrated based on the

same technical document and is assessed by the assessing entity as part of the UTP verification procedure.

technical document referred in Article 13 of CCS TSI and is checked by the Notified Body as part of EC verification.

d₂) If the unit has electrical or electronic equipment on board emitting interference electromagnetic fields:

- close to the wheel sensor of an axle counter, or

- induced by the return current via the rail if applicable.-

The 'influencing unit' (as defined in the technical document referenced in Appendix D.2 Index [A]) of which the unit is planned to be part shall be compliant with

the applicable axle counters requirements. These requirements should be captured in coordination with the authorities competent for the area of use of the unit

specific cases for axle counters notified under Article 13 of CCS TSI

by applying the harmonised vehicle test methods referred to in the technical document referenced in Appendix D.2 index [A]. Compliance of the unit can be demonstrated based on the

ERA document ERA/ERTMS/033281 V5 and is assessed by the assessing entity as part of the UTP verification procedure.

technical document referred in Article 13 of CCS TSI and is checked by the Notified Body as part of EC verification.

e) The unit must be equipped with the manual coupling system in accordance with the prescriptions set out in Appendix C ~~S~~section 1 including the fulfilment of ~~S~~section 8 or with any semi-automatic or automatic ~~standardised~~ coupling system.

f) The brake system must be in accordance with the conditions of Appendix C sections 9, 14 and 15 when applying the reference case set out in point 4.2.4.2.

g) The unit must be marked with all applicable markings in accordance with ~~EN 15877-1:2012, except the marking defined in its clause 4.5.25(b)~~ the specification referenced in Appendix D Index [2].

h) The minimum and, where relevant, maximum parking brake force, ~~shall be marked as set out in Figure 3, 30 mm below the marking defined in clause 4.5.3 of EN 15877-1~~ the number of wheelsets (N) and the number of wheelsets on which the parking brake is applied (n) shall be marked as set out in Figure 1:

 OTIF	Uniform Technical Prescription (UTP)		UTP WAG	
	ROLLING STOCK - FREIGHT WAGONS		Page 63 of 148	
Status: DRAFT	Version 1	TECH-23020	Original: EN	Date: 17.5.2023

Figure 3-1 Marking of the parking brake force



On the basis of Article 3a §1 of ~~ATMF~~[the ATMF UR](#), vehicles which have been authorised according to EU law which is equivalent to this UTP and which are compliant with all requirements set out in section 4.2 and in point 7.1.2 shall be deemed as admitted to operation by all Contracting States.

When an international agreement to which the European Union is party provides for reciprocal legal provisions units which have been authorised to operate according to said international agreement and comply with all requirements set out in section 4.2 and in this point 7.1.2 shall be deemed as authorised for placing on the market in the States of the European Union.

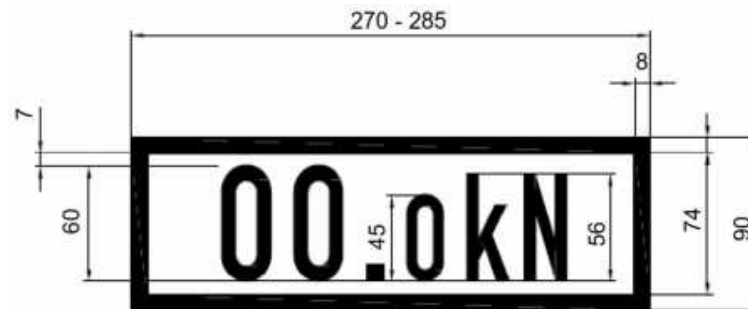
7.2 General rules for implementation

7.2.1 Substitution of interoperability constituents

This section deals with substitutions of constituents

ICs) as defined in Article 2(g) of ~~ATMF~~[the ATMF UR](#), ~~(Appendix G to the Convention)~~.

as referred to in Article 2 of Directive (EU) 2016/797.

The following categories have to be considered:

- Certified ICs: Components which correspond to an IC in Chapter 5 and which are holding a certificate of conformity.
- Other components: Any component, which is not corresponding to an IC in Chapter 5.

- Non-certified ICs: Components which correspond to an IC in Chapter 5 but are not holding a certificate of conformity and which are produced before the expiry of the

 OTIF	Uniform Technical Prescription (UTP)			UTP WAG
	ROLLING STOCK - FREIGHT WAGONS			Page 64 of 148
Status: DRAFT	Version 1	TECH-23020	Original: EN	Date: 17.5.2023

transitional period referred to in ~~section 6.3~~
[Article 8⁴⁰](#).

Table 11 shows the possible permutations.

Table 11 Substitution permutation table

	... substituted by ...		
	... certified ICs	... other components	... non-certified ICs
Certified ICs ...	check	not possible	check
Other components ...	not possible	check	not possible
Non-certified ICs ...	check	not possible	check

The word “check” in table 11 means that the entity in charge of maintenance (ECM) may under its responsibility substitute a component by another one utilising the same function and at least the same performance in accordance with the relevant UTP requirements considering that these components are

- suitable, i.e. conform to the relevant UTP(s),
- used within its area of use,
- enabling interoperability,
- meeting the essential requirements, and
- in line with restrictions stated in the technical file.

7.2.2 Changes to ~~an existing unit in operation~~ or to an existing unit type

7.2.2.1 Introduction

Point 7.2.2 defines the principles to be applied by

the entity managing the changes.

The entity managing the change is either the holder of the Certificate of Operation of a vehicle, which, in accordance with Article 11 § 8 of ~~ATMF~~[the ATMF UR](#), is the keeper, or, if the change concerns a type, the holder of the Design Type Certificate.

the entities managing the change and authorising entities in line with the EC verification procedure described in Article 15(9), Article 21(12) and Annex IV of Directive (EU) 2016/797. This procedure is further developed in Article 13, 15

⁴⁰ [Article 8 of Commission Regulation \(EU\) No 321/2013 of 13 March 2013, as last amended by \[\\[add new reference\\]\]\(#\) concerning the technical specification for interoperability relating to the subsystem ‘rolling stock — freight wagons’.](#)

 OTIF	Uniform Technical Prescription (UTP)			UTP WAG
	ROLLING STOCK - FREIGHT WAGONS			Page 65 of 148
Status: DRAFT	Version 1	TECH-23020	Original: EN	Date: 17.5.2023

and 16 of Commission Implementing Regulation (EU) 2018/545⁴¹ and in Decision 2010/713/EC⁴².

This point 7.2.2 applies in case of any change(s) to ~~an existing~~ unit in operation or to an existing unit type, including renewal or upgrade.

It does not apply in case of changes:

- that do not introduce a deviation from the technical files accompanying the UTP declarations for verification for the subsystems, if any, and
- that do not have an impact on basic parameters not covered by the UTP declaration, if any.

The holder of the

Design Type Certificate, if this is not itself the entity managing the change, | vehicle type authorisation

shall provide, under reasonable conditions, the information necessary for assessing the changes to the entity managing the change.

7.2.2.2 Rules to manage changes in both a unit or a unit type

Parts and basic parameters of the unit that are not affected by the change(s) are exempt from conformity assessment against the provisions in this UTP.

Without prejudice to clause 7.2.2.3, compliance with the requirements of this UTP or ~~the~~

UTP Noise or the equivalent TSI

~~TSI Noise~~ (Commission Regulation EU No 1304/2014⁴³ (TSI NOI), see clause 7.2 of that TSI)

shall only be needed for the basic parameters in this UTP which may be affected by the change(s).

Any basic parameter of a vehicle or a vehicle type affected by the changes shall be analysed and categorised in one of the following categories:

1. Changes that do not introduce a deviation from the technical file.
2. Changes that do not fall into category 1 and which do not change the basic design characteristics as per table 11a.
3. Changes that do not fall into category 2 and which do not require a new admission

In accordance with Articles 15 and 16 of Commission Implementing Regulation (EU) 2018/545 and Decision 2010/713/EU and by application of modules SB, SD/SF or SH1 for the EC verification, and if relevant in accordance with Article 15(5) of Directive (EU) 2016/797, the entity managing the change shall inform a notified body of all changes affecting the conformity of the subsystem with requirements of the relevant TSI(s) requiring new checks by a notified body. This information shall be provided by the entity managing the change with

⁴¹ Commission Implementing Regulation (EU) 2018/545 of 4 April 2018 establishing practical arrangements for the railway vehicle authorisation and railway vehicle type authorisation process pursuant to Directive (EU) 2016/797 of the European Parliament and of the Council. (OJ L 90, 6.4.2018, p. 66).

⁴² Commission Decision 2010/713/EU of 9 November 2010 on modules for the procedures for assessment of conformity, suitability for use and EC verification to be used in the technical specifications for interoperability adopted under Directive 2008/57/EC of the European Parliament and of the Council. (OJ L 319, 4.12.2010, p. 1).

⁴³ Commission Regulation (EU) No 1304/2014 of 26 November 2014, as last amended by [new reference] on the technical specification for interoperability relating to the subsystem 'rolling stock – noise', amending Decision 2008/232/EC and repealing Decision 2011/229/EU (OJ L 356, 12.12.2014, p. 421).

 OTIF	Uniform Technical Prescription (UTP)			UTP WAG
	ROLLING STOCK - FREIGHT WAGONS			Page 66 of 148
Status: DRAFT	Version 1	TECH-23020	Original: EN	Date: 17.5.2023

in accordance with the criteria in this section.

4. Changes that do not fall into categories 1-3 and specific changes described in this section.

For category 1 no further action is required.

For categories 2 and 3 the technical file shall be updated and the holder of the Design Type Certificate or, if there is no Design Type Certificate, the holder of the Certificate of Operation shall make the relevant information available to the competent authorities upon request.

For category 4, a new admission in accordance with Article 10 § 11 of ~~ATMF~~ [the ATMF UR](#) is required. An assessing entity shall be informed by the entity managing the change of all changes to the subsystem that affect the conformity with requirements of the relevant UTPs(s) and which require new checks by the assessing entity.

Modules SB, SD/SF or SH1 as defined in UTP GEN—D shall apply mutatis mutandis to the assessment of changes.

The assessing entity shall be provided with all relevant technical documentation relating to the existing Design Type Certificate and, if available, the Certificate of Operation.

For physical vehicles this information shall be provided by the keeper, as holder of the Certificate of Operation.

If the change is to a type of vehicle, the holder of the Design Type Certificate shall provide this information.

In case of changes requiring reassessment of the safety requirements set out in clauses 4.2.4.2 for the brake system, a new vehicle admission shall be required, unless one of the following conditions is met:

- After the change, the brake system fulfils the conditions of C.9 and C.14 of Appendix C, or
- Both the original and changed brake systems fulfil the safety requirements set out in clause 4.2.4.2

corresponding references to the technical documentation relating to the existing EC type or design examination certificate.

Without prejudice of the general safety judgement mandated in article 21(12)(b) of Directive (EU) 2016/797, in case of changes requiring reassessment of the safety requirements set out in clauses 4.2.4.2 for the brake system, a new authorization for placing on the market will be required unless one of the following conditions are met:

- The brake system fulfils the conditions of C.9 and C.14 of Appendix C after change or,
- Both the original and changed brake systems fulfil the safety requirements set out in clause 4.2.4.2

 OTIF	Uniform Technical Prescription (UTP)			UTP WAG
	ROLLING STOCK - FREIGHT WAGONS			Page 67 of 148
Status: DRAFT	Version 1	TECH-23020	Original: EN	Date: 17.5.2023

Changes of category 3 and 4 require assessment as to whether the overall safety level of the vehicle is adversely affected by the changes.

The following changes shall fall into category 3:

- Changes above the thresholds set out in column 3 and below thresholds set out in column 4 of Table 11a and which do not adversely affect the overall safety level of the vehicle.

The following changes shall fall into category 4:

- Changes above the thresholds set out in column 4 of Table 11a and changes which may adversely affect the overall safety level of the vehicle.

Whether the changes are beyond or above the thresholds mentioned above shall be determined in reference to the values of the parameters at the time

of the most recent admission of the rolling stock or rolling stock type.

Changes not referred to in the paragraph above are deemed not to have any impact on the basic design characteristics and

will fall into category 1 or 2, unless the assessment of the overall safety level of the vehicle concludes that safety is adversely affected by the changes. In such case the changes fall into category 4.

The assessment as to whether the overall safety level of the vehicle is adversely affected shall be carried out in accordance with UTP GEN-G and shall cover all changes concerning basic parameters of table 1, related to all the essential requirements, in particular the requirements “Safety” and “Technical compatibility”.

National migration strategies related to the implementation of other TSIs (e.g. TSIs covering fixed installations) shall be taken into account when defining to what extent the TSIs covering rolling stock needs to be applied.

The basic design characteristics of the rolling stock are defined in Table 11a.

Based on these tables and on the safety judgement mandated in Article 21(12)(b) of Directive (EU) 2016/797, the changes shall be categorised as follows:

- 15(1)(c) of Commission Implementing Regulation (EU) 2018/545 if they are above the thresholds set out in column 3 and below thresholds set out in column 4 unless the safety judgement mandated in Article 21(12)(b) of Directive (EU) 2016/797 requires to categorise them as 15(1)(d), or
- 15(1)(d) of Commission Implementing Regulation (EU) 2018/545 if they are above the thresholds set out in column 4 or if the safety judgement mandated in Article 21(12)(b) of Directive (EU) 2016/797 requires to categorise them as 15(1)(d).

of the last authorisation of the rolling stock or rolling stock type.

will be categorised as 15(1)(a) or 15(1)(b) of Commission Implementing Regulation (EU) 2018/545, unless the safety judgement mandated in Article 21(12)(b) of Directive (EU) 2016/797 requires to categorise them as 15(1)(d).

The safety judgement mandated in Article 21(12)(b) of Directive (EU) 2016/797 shall cover all changes concerning basic parameters of table 1, related to all the essential requirements, in particular the requirements “Safety” and “Technical compatibility”.

 OTIF	Uniform Technical Prescription (UTP) ROLLING STOCK - FREIGHT WAGONS			UTP WAG Page 68 of 148
	Status: DRAFT	Version 1	TECH-23020	Original: EN

Without prejudice to clause 7.2.2.3, all changes shall remain compliant with the applicable UTPs, regardless of their classification.

Without prejudice to clause 7.2.2.3, all changes shall remain compliant with the applicable TSIs regardless their classification.

The replacement of a whole element within a rake of permanently connected elements after severe damage does not require a conformity assessment against this UTP, as long as the element is identical to the one it replaces. Such element must be traceable and certified in accordance with any national or international rule, or any code of practice widely acknowledged in the railway domain.

Table 11a Basic design characteristics related to basic parameters set out in the UTP WAG

1. Clause	2. Related basic design characteristic(s)	3. Changes ⁴⁴ impacting the basic design characteristic which remain within the range of acceptable parameters with respect to technical compatibility with the area of use	4. Changes ⁴⁵ impacting the basic design characteristic which go beyond the range of acceptable parameters with respect to technical compatibility with the area of use
4.2.2.1.1 End coupling	Type of end coupling	Change of end coupler type	N/A
4.2.3.1 Gauging	Reference profile	N/A	Change of reference profile the vehicle is conform to
	Minimum vertical convex curve radius capability	Change in minimum vertical convex curve radius capability the unit is compatible with of more than 10%	N/A
	Minimum vertical concave curve radius capability	Change in minimum vertical concave curve radius capability the unit is compatible with of more than 10%	N/A

⁴⁴ EU title: "Changes impacting the basic design characteristic and not classified as 21(12)(a) of Directive (EU) 2016/797"

⁴⁵ EU title: "Changes impacting the basic design characteristic and classified as 21(12)(a) of Directive (EU) 2016/797"

 OTIF	Uniform Technical Prescription (UTP)		UTP WAG	
	ROLLING STOCK - FREIGHT WAGONS		Page 69 of 148	
Status: DRAFT	Version 1	TECH-23020	Original: EN	Date: 17.5.2023

1. Clause	2. Related basic design characteristic(s)	3. Changes ⁴⁴ impacting the basic design characteristic which remain within the range of acceptable parameters with respect to technical compatibility with the area of use	4. Changes ⁴⁵ impacting the basic design characteristic which go beyond the range of acceptable parameters with respect to technical compatibility with the area of use
4.2.3.2. Compatibility with load carrying capacity of lines	Permissible payload for different line categories	Change ^(*) of any of the vertical loading characteristics resulting in a change of the line category(ies) the wagon is compatible with	N/A
4.2.3.3 Compatibility with train detection systems	Compatibility with train detection systems	N/A	Change of declared compatibility with one or more of the three train detection systems: Track circuits Axle counters Loop equipment
4.2.3.4 Axle bearing condition monitoring	On-board detection system	N/A	Fitting/Removal of on-board detection system
4.2.3.5 Running safety	Combination of maximum speed and maximum cant deficiency for which the unit was assessed	N/A	Increase in maximum speed of more than 15 km/h or change of more than $\pm 10\%$ in maximum admissible cant deficiency
	Rail inclination	N/A	Change of rail inclination the vehicle is conform to ^(**)
4.2.3.5.3 Derailment detection and prevention function	Presence and type of derailment detection and prevention function(s)	Fitting/removal of prevention/detection function	N/A

 OTIF	Uniform Technical Prescription (UTP)		UTP WAG	
	ROLLING STOCK - FREIGHT WAGONS		Page 70 of 148	
Status: DRAFT	Version 1	TECH-23020	Original: EN	Date: 17.5.2023

1. Clause	2. Related basic design characteristic(s)	3. Changes ⁴⁴ impacting the basic design characteristic which remain within the range of acceptable parameters with respect to technical compatibility with the area of use	4. Changes ⁴⁵ impacting the basic design characteristic which go beyond the range of acceptable parameters with respect to technical compatibility with the area of use
4.2.3.6.2 Characteristics of wheelsets	Wheelset gauge	N/A	Change of track gauge the wheelset is compatible with
4.2.3.6.3 Characteristics of wheels	Minimum required in-service wheel diameter	Change of minimum required in-service diameter of more than 10 mm	N/A
4.2.3.6.6 Automatic variable gauge systems	Wheelset gauge changeover facility	Change in the unit leading to a change in the changeover facility(ies) the wheelset is compatible with	Change of track gauge(s) the wheelset is compatible with
4.2.4.3.2.1 Service brake	Stopping distance	Change of stopping distance of more than $\pm 10\%$ Note: Brake weight percentage (also called 'lambda' or 'braked mass percentage') or braked mass may also be used, and can be derived (directly or via stopping distance) from deceleration profiles by a calculation. The allowed change is the same ($\pm 10\%$)	N/A
	Maximum deceleration for the load condition 'design mass under normal payload' at the maximum design speed	Change of more than $\pm 10\%$ on the maximum average brake deceleration	N/A
4.2.4.3.2.2 Parking brake	Parking brake	Parking brake function installed/removed	N/A

 OTIF	Uniform Technical Prescription (UTP)			UTP WAG
	ROLLING STOCK - FREIGHT WAGONS			Page 71 of 148
Status: DRAFT	Version 1	TECH-23020	Original: EN	Date: 17.5.2023

1. Clause	2. Related basic design characteristic(s)	3. Changes ⁴⁴ impacting the basic design characteristic which remain within the range of acceptable parameters with respect to technical compatibility with the area of use	4. Changes ⁴⁵ impacting the basic design characteristic which go beyond the range of acceptable parameters with respect to technical compatibility with the area of use
4.2.4.3.3 Thermal capacity	Thermal capacity expressed in terms of Speed Gradient Brake distance	N/A	New reference case declared
4.2.4.3.4 Wheel slide protection (WSP)	Wheel slide protection	N/A	Fitting/removal of WSP function
4.2.5 Environmental conditions	Temperature range	Change of temperature range (T1, T2, T3)	N/A
	Snow, ice and hail conditions	Change of the selected range 'snow, ice and hail' (nominal or severe)	N/A

(*) Change of the loading characteristics is not to be re-assessed in operation (loading/unloading of the wagon)

(**) The rolling stock fulfilling one of the following conditions are deemed to be compatible with all rail inclinations:

- Rolling stock assessed according to EN 14363:2016
- Rolling stock assessed according to EN 14363:2005 (amended or not amended by ERA/TD/2012-17/INT) or UIC 518:2009 with the result, that there is no restriction to one rail inclination
- vehicles assessed according to EN 14363:2005 (amended or not amended by ERA/TD/2012-17/INT) or UIC 518:2009 with the result, that there is a restriction to one rail inclination and a new assessment of the wheel-rail-contact test conditions based on real wheel- and rail profiles and measured track gauge show compliance with the requirements on wheel-rail-contact conditions of EN 14363:2016

In order to establish the type or design examination certificate⁴⁶

⁴⁶ In EU law reference is made to the EC type or design examination certificate.

 OTIF	Uniform Technical Prescription (UTP)			UTP WAG
	ROLLING STOCK - FREIGHT WAGONS			Page 72 of 148
Status: DRAFT	Version 1	TECH-23020	Original: EN	Date: 17.5.2023

in accordance with UTP GEN-D, the assessing entity | , the notified body selected by the entity managing the change ~~is permitted to~~ may refer to:

- the original type or design examination certificate for parts of the design that are unchanged or those that are changed but do not affect the conformity of the subsystem, as far as it is still valid ~~(during 10 year phase B period).~~
- additional type or design examination certificate (amending the original certificate) for modified parts of the design that affect the conformity of the subsystem with the ~~latest revision of this UTP or equivalent TSI in force at that time~~ TSIs referred to in the certification framework defined in point 7.2.3.1.1.

~~If in case T~~ The validity period of the type or design examination certificate for the ~~modified original type, type variant⁴⁷ or type version⁴⁸ shall be~~ is limited to 10 years (due to the application of the former Phase A/B concept), from the date of issuing, without exceeding the validity period of the type or design examination certificate for the modified type, type variant⁴⁹ or type version⁵⁰ shall be limited to 14 years after the date of appointment of an assessing entity by the applicant for the initial rolling stock type (beginning of phase A of the original type or design examination certificate).

7.2.2.3 Particular rules for ~~existing~~ units

in operation of which the admission to international traffic was prior to 1 January 2015 and was not based on UTPs or equivalent EU provisions

in operation not covered by an EC declaration of verification with a first authorisation for placing in service before 1 January 2015

The following rules apply, in addition to clause 7.2.2.2, to ~~existing~~ units in operation with a first admission to international traffic before 1 January 2015, which were not assessed for compliance with the UTPs before their admission.

The following rules apply, in addition to clause 7.2.2.2, to ~~existing~~ units in operation with a first authorisation for placing in service before 1 January 2015, where the scope of the change has an impact on basic parameters not covered by the EC declaration.

Changes shall be deemed compliant with the technical requirements in this UTP if:

- the values of the parameters set out in the UTP are improved in the direction of the value defined in the UTP and
- the entity managing the change demonstrates that the essential

The compliance with technical requirements of this TSI is deemed established when a basic parameter is improved in the direction of the TSI defined performance and the entity managing the change demonstrates that the corresponding essential requirements are met and the safety

⁴⁹ In Commission Implementing Regulation (EU) 2018/545, ‘vehicle type variant’ means an option for the configuration of a vehicle type that is established during a first authorisation of the vehicle type in accordance with Article 24(1) or changes within an existing vehicle type during its life cycle that require a new authorisation of the vehicle type in accordance with Articles 24(1) and 21(12) of Directive (EU) 2016/797.

⁵⁰ In Commission Implementing Regulation (EU) 2018/545, ‘vehicle type version’ means an option for the configuration of a vehicle type or type variant or changes within an existing type or type variant during its life cycle, created to reflect changes to the basic design characteristics that do not require a new authorisation of the vehicle type in accordance with Articles 24(1) and 21(12) of Directive (EU) 2016/797.

 OTIF	Uniform Technical Prescription (UTP) ROLLING STOCK - FREIGHT WAGONS			UTP WAG Page 73 of 148
	Status: DRAFT	Version 1	TECH-23020	Original: EN

<p>requirements which are concerned by the change are met and</p> <ul style="list-style-type: none"> – the safety level is not reduced. <p>The entity managing the change shall, in cases where the UTP requirement was not met, justify the reason why the UTP requirement was not met.</p>	<p>level is maintained and, where reasonably practicable, improved.</p> <p>The entity managing the change shall in this case justify the reasons for which the TSI defined performance was not met, taking into account migration strategies of other TSIs as stated in section 7.2.2.2.</p>
---	--

This justification shall be in the technical file, if any, or in the original technical documentation of the unit.

The particular rule set out in the above paragraph is not applicable in changes impacting the basic parameters

as | and classified as 21(12)a⁵¹

set out in table 11b. For those changes, compliance with the UTP requirements is mandatory.

Table 11b Changes to basic parameters of vehicles of which the admission to international traffic was not based on UTPs or equivalent EU provisions⁵²

UTP clause	Related basic design characteristic(s)	Changes which shall comply with the UTP requirements ⁵³
4.2.3.1 Gauging	Reference profile	Change of reference profile the unit is conform to
4.2.3.3 Compatibility with train detection systems	Compatibility with train detection systems	Change of declared compatibility with one or more of the three train detection systems: Track circuits Axle counters Loop equipment

⁵¹ Article 21(12) of European Union Directive (EU) 2016/797, which reads: “In the event of renewal or upgrading of existing vehicles which already have a vehicle authorisation for placing on the market, a new vehicle authorisation for placing on the market shall be required if:

- (a) changes are made to the values of the parameters referred to in point (b) of paragraph 10 which are outside the range of acceptable parameters as defined in the TSIs;
- (b) the overall safety level of the vehicle concerned may be adversely affected by the works envisaged; or
- (c) it is required by the relevant TSIs.”

⁵² Title of this table in the TSI: “Changes to basic parameters for which compliance with TSI requirements is mandatory for rolling stock not holding an EC type or design examination certificate”.

⁵³ Title of this column in the TSI: “Changes impacting the basic design characteristic and classified as 21(12)(a) of Directive (EU) 2016/797”.

 OTIF	Uniform Technical Prescription (UTP)			UTP WAG
	ROLLING STOCK - FREIGHT WAGONS			Page 74 of 148
Status: DRAFT	Version 1	TECH-23020	Original: EN	Date: 17.5.2023

4.2.3.4 Axle bearing condition monitoring	On-board detection system	Fitting/Removal of on-board detection system
4.2.3.6.2 Characteristics of wheelsets	Wheelset gauge	Change of track gauge the wheelset is compatible with
4.2.3.6.6 Automatic variable gauge systems	Wheelset gauge changeover facility	Change of track gauge(s) the wheelset is compatible with

7.2.2.4 Rules for the extension of the area of use for ~~existing~~ units in operation

having an authorisation in accordance with Directive 2008/57/EC or in operation before 19 July 2010

- (1) This clause sets out rules for the extension of the area of use of existing units which are not in full compliance with this UTP.

In accordance with Article 10 § 4 of ~~ATMF~~the ATMF UR, where the applicant wishes to extend the area of use of a vehicle which has already been admitted to operation, it shall update the vehicle's documentation concerning this additional area of use and apply for the process defined in Article 6 § 4 of ~~ATMF~~the ATMF UR.

In the absence of full conformity with this TSI, point 2 applies to units that fulfils the following conditions when requesting the extension of its area of use in accordance with Article 21(13) of Directive (EU) 2016/797:

- (a) they have been authorised in accordance with Directive 2008/57/EC or put in operation before 19 July 2010;
- (b) they are registered with "Valid" registration code "00", in the National Vehicle Register in accordance with Commission Decision 2007/756/EC⁵⁴ or in the European Vehicle Register in accordance with Commission Implementing Decision (EU) 2018/1614⁵⁵ and maintained in a safe state of running in accordance with Commission Implementing Regulation (EU) 2019/779⁵⁶.

The following provisions for extension of area of use apply also in combination with a new

⁵⁴ Commission Decision 2007/756/EC of 9 November 2007 adopting a common specification of the national vehicle register provided for under Articles 14(4) and (5) of Directives 96/48/EC and 2001/16/EC. [\(OJ L 305, 23.11.2007, p. 30\)](#)

⁵⁵ Commission Implementing Decision (EU) 2018/1614 of 25 October 2018 laying down specifications for the vehicle registers referred to in Article 47 of Directive (EU) 2016/797 of the European Parliament and of the Council and amending and repealing Commission Decision 2007/756/EC. [\(OJ L 268, 26.10.2018, p. 53\)](#)

⁵⁶ Commission Implementing Regulation (EU) 2019/779 of 16 May 2019 laying down detailed provisions on a system of certification of entities in charge of maintenance of vehicles pursuant to Directive (EU) 2016/798 of the European Parliament and of the Council and repealing Commission Regulation (EU) No 445/2011. [\(OJ L 139 I, 27.5.2019, p. 360\)](#)

 OTIF	Uniform Technical Prescription (UTP) ROLLING STOCK - FREIGHT WAGONS			UTP WAG Page 75 of 148
	Status: DRAFT	Version 1	TECH-23020	Original: EN

- (2) Extending the area of use of the units referred to in point 1 by complementary vehicle admission shall be based on the existing admission, if any, and on the technical compatibility between the units and the network(s) of the state(s) concerned and compliance with the Basic Design Characteristics of Table 11a of this UTP, taking into account any restrictions or limitations.

The applicant shall provide the Competent Authority with the technical certificates defined in Article 11 of ~~ATMF~~[the ATMF UR](#), including all attachments and any other evidence of compliance with the requirements set out in this UTP

or with provisions having equivalent effect, for each basic parameter referred to in column 1 of Table 11a of this UTP, through one or a combination of the following:

- (a) compliance with requirements set out in this UTP as referred above;
- (b) compliance with corresponding requirements set out in a previous UTP as referred above;
- (c) compliance with alternative specifications deemed to have equivalent effect to the relevant requirements set out in this UTP as referred above;
- (d) evidence that the requirements for technical compatibility with the network of the extended area of use are equivalent to the requirements for technical compatibility with the network for which the units is already admitted or in operation.

Such evidence shall be provided by the applicant.

authorisation as defined in point (a) of Article 14(3) of Regulation (EU) 2018/545.

Authorisation for an extended area of use of the units referred to in point 1 shall be based on the existing authorisation, if any, the technical compatibility between the unit and the network in accordance with point (d) of Article 21(3) of Directive (EU) 2016/797 and compliance with the Basic Design Characteristics of Table 11a of this TSI, taking into account any restrictions or limitations.

The applicant shall provide an 'EC' declaration of verification' accompanied by technical files giving evidence of compliance with the requirements set out in this TSI,

Such evidence shall be provided by the applicant and may be based on the information of the register of railway infrastructure (RINF).

- (3) The equivalent effect of alternative specifications to the requirements of this UTP (point 2(c)) and the equivalence of requirements for technical compatibility with the network (point 2(d)) shall be justified and documented by the applicant by applying the risk management process set out in Annex I of UTP GEN-G. The applicant shall provide a positive assessment by an assessment body in accordance with UTP GEN-G.

- (4) In addition to the requirements mentioned in point 2 and where applicable, the applicant shall provide

an 'EC' declaration of verification accompanied by technical files giving

evidence of compliance with the following:

 OTIF	Uniform Technical Prescription (UTP)			UTP WAG
	ROLLING STOCK - FREIGHT WAGONS			Page 76 of 148
Status: DRAFT	Version 1	TECH-23020	Original: EN	Date: 17.5.2023

- (a) specific cases relating to any part of the extended area of use, listed in this UTP, or the UTP Noise, or the equivalent TSIs⁵⁷.
- (b) the national technical requirements in the meaning of Article 12 of the APTU UR.

(5) (reserved)

The authorising entity shall make publicly available through the Agency website details of the alternative specifications referred to in point 2 (c) and of the requirements for technical compatibility with the network referred to in point 2 (d) on the basis of which it granted authorisations for the extended area of use.

(6) (reserved)

Where an authorised vehicle benefited from non-application of TSIs or part of them pursuant to Article 9 of Directive 2008/57/EC, the applicant shall seek derogation(s) in the Member States of the extended area of use in accordance to Article 7 of Directive (EU) 2016/797.

(7) In accordance with Article 19 of ~~ATMF~~the ATMF UR, wagons accepted under the Regolamento Internazionale dei Veicoli (RIV) shall be deemed admitted in accordance with the conditions under which they were used, including the area of use where they are operated.

In accordance with Article 54(2) of Directive (EU) 2016/797, wagons used under Regolamento Internazionale Veicoli (RIV) shall be deemed authorised in accordance with the conditions under which they were used, including the area of use where they are operated. Following a change which requires a new authorisation for placing on the market in accordance with Article 21(12) of Directive (EU) 2016/797, wagons accepted under the latest RIV agreement shall conserve the area of use in which they were operating without further checks on the unchanged parts.

Wagons accepted under the latest RIV agreement that are changed shall keep their area of use according to their registration without further checks on the unchanged parts.

The changes shall be assessed in accordance with point 7.2.2.2 of this UTP.

7.2.3 Rules related to the type or design examination certificates

7.2.3.1 Rolling stock subsystem

This point concerns the procedure referred to in Article 10 of ~~ATMF~~the ATMF UR according to which a Design Type Certificate related to a vehicle type and a Certificate of Operation related to a vehicle are granted.

This point concerns a rolling stock type (unit type in the context of this TSI), as defined in Article 2(26) of Directive (EU) 2016/797, which is subject to an EC type or design verification procedure in accordance with section 6.2 of this TSI. It also applies to the EC type or design verification procedure in accordance with the TSI NOise, which refers to this TSI for its scope of application to freight units.

The basis of assessment is defined in columns ‘Design review’ and ‘Type test’ of Appendix F of this UTP and of Appendix C of the UTP Noise.

⁵⁷ For Member States of the European Union, the specific cases are set out in the TSI NOise (Regulation (EU) No 1304/2014) and CCS TSI (Regulation (EU) 2016/919).

 OTIF	Uniform Technical Prescription (UTP)		UTP WAG	
	ROLLING STOCK - FREIGHT WAGONS		Page 77 of 148	
Status: DRAFT	Version 1	TECH-23020	Original: EN	Date: 17.5.2023

The TSI assessment basis for an EC type or design examination is defined in columns 'Design review' and 'Type test' of Appendix F of this TSI and of Appendix C of the TSI Noise.

7.2.3.1.1 ~~Phase A~~ Definitions

~~Phase A starts at the moment an assessing entity is appointed and ends when the Design Type Certificate is issued, or after four years, whichever comes first.~~

~~During Phase A, the applicable technical requirements shall not change.~~

~~When a revision of this UTP or of the UTP Noise comes into force during the phase A period, it is permissible (but not mandatory) to use the revised version(s), either totally or for particular sections, unless explicitly otherwise specified in the revision of these UTPs. In case of application limited to particular sections, the applicant has to justify and document that applicable requirements remain consistent, and this has to be approved by the Competent Authority.~~

~~Phase A starts once a notified body, which is responsible for EC verification, is appointed by the applicant and ends when the EC type or design examination certificate is issued.~~

~~The TSI assessment basis for a type is defined for a phase A period, with a duration of maximum four years. During the phase A period the assessment basis for EC verification to be used by the notified body will not change.~~

~~When a revision of this TSI or of the TSI Noise comes into force during the phase A period, it is permissible (but not mandatory) to use the revised version(s), either totally or for particular sections, unless explicitly otherwise specified in the revision of these TSIs. In case of application limited to particular sections, the applicant has to justify and document that applicable requirements remain consistent, and this has to be approved by the notified body.~~

(1) Initial assessment framework

The initial assessment framework is the set of UTPs (this UTP and the UTP Noise) applicable at the beginning of the design phase when the assessing entity is appointed by the applicant.

(2) Certification framework

The certification framework is the set of UTPs (this UTP and the UTP Noise) -applicable at the time ~~of issuing~~ the type or design examination certificate is issued. It is the initial assessment framework amended with the revisions of UTPs that came into force during the design phase.

(3) Design phase

The design phase is the period starting once an assessing entity, which is responsible for UTP verification, is appointed by the applicant and ending when the type or design examination certificate is issued.

A design phase can cover a type and one or several type variant(s) and type version(s). For all type variant(s) and type version(s), the design phase is considered as starting at the same time as for the main type.

(4) Production phase

The production phase is the period during which units may receive a Certificate of Operation, in the meaning of Article 11 of the ATMF UR, on the basis

Production phase

The production phase is the period during which units may be placed on the market on the basis of

 OTIF	Uniform Technical Prescription (UTP)		UTP WAG	
	ROLLING STOCK - FREIGHT WAGONS		Page 78 of 148	
Status: DRAFT	Version 1	TECH-23020	Original: EN	Date: 17.5.2023

of the same type or design examination certificate.

(5) Unit in operation

A unit is in operation when it has a valid Certificate of Operation, or equivalent status in accordance with EU law and is registered as such in a vehicle register in accordance with Article 13 of the ATMF UR.

an EC declaration of verification referring to a valid EC type or design examination certificate.

Unit in operation

A unit is in operation when it is registered with 'Valid' registration code '00', in the National Vehicle Register in accordance with Decision 2007/756/EC or in the European Vehicle Register in accordance with Implementing Decision (EU) 2018/1614 and maintained in a safe state of running in accordance with Implementing Regulation (EU) 2019/779.

7.2.3.1.2 ~~Phase B~~ Rules related to the type or design examination certificate

~~Phase B starts at the moment the Design Type Certificate is issued and ends 10 years later.~~

~~During the Phase B period, Certificates of Operation may be issued for vehicles complying with the Design Type Certificate.~~

~~Modifications to this UTP or the UTP Noise shall not apply during the Phase B period, unless specified otherwise in these revised UTPs.~~

~~The phase B period defines the period of validity of the EC type or design examination certificate once it is issued by the notified body. During this time, units may be EC certified on the basis of conformity to type.~~

~~The EC type or design examination certificate of EC verification for the subsystem is valid for a ten year phase B period after its issue date, even if a revision of this TSI or of the TSI Noise come into force, unless explicitly otherwise specified in the revision of these TSIs. During this period of validity, new rolling stock of the same type is permitted to be placed on the market on the basis of an EC declaration of verification referring to the type certificate of verification.~~

~~The updated technical documentation related to the EC type or design examination certificate is referred to in the technical file accompanying the EC declaration of verification issued by the applicant for rolling stock declared as conformant to the modified type.~~

(1) The assessing entity shall issue the type or design examination certificate referring to the certification framework.

(2) When a revision of this UTP or of the UTP Noise comes into force during the design phase, the assessing entity shall issue the type or design examination certificate in accordance with the following rules:

- For changes in the UTPs that are not referenced in Appendix A, conformity with the initial assessment framework leads to conformity with the certification framework. The assessing entity shall issue the type or design examination certificate referring to the certification framework without additional assessment.

 OTIF	Uniform Technical Prescription (UTP)			UTP WAG
	ROLLING STOCK - FREIGHT WAGONS			Page 79 of 148
Status: DRAFT	Version 1	TECH-23020	Original: EN	Date: 17.5.2023

– For changes in the UTPs that are referenced in Appendix A, their application is mandatory in accordance with the transition regime laid down in that Appendix. During the transition period, the assessing entity may issue the type or design examination certificate referring to the certification framework without additional assessment. The assessing entity shall list in the type or design examination certificate all the points assessed in accordance with the initial assessment framework.

- (3) When several revisions of this UTP or of the UTP Noise come into force during the design phase, point (2) shall apply to all revisions successively.
- (4) It is always permitted (but not mandatory) to use the most recent version of any UTP, either totally or for particular sections, unless explicitly otherwise specified in the revision of those UTPs. If the application is limited to particular sections, the applicant has to justify and document that the applicable requirements remain consistent. This consistency has to be approved by the assessing entity.

7.2.3.1.3 Validity of the type or design examination certificate

- (1) When a revision of this UTP or of the UTP Noise comes into force, the type or design examination certificate for the subsystem remains valid unless it is required to be revised in accordance with the specific transition regime of a UTP change.
- (2) Only the changes to the UTPs with a specific transition regime can apply to units in production phase or to units in operation.

7.2.3.2 Interoperability constituents

- (1) In accordance with UTP GEN-D, Contracting States may require the mandatory separate assessment of ICs. If not required by the Contracting State, separate assessment of ICs may be carried out on a voluntary basis.

In case of conformity assessment of an IC as part of the subsystem, the compliance of the IC with the applicable provisions is verified by applying the modules for subsystem in accordance with section 6.2 of this UTP.

This point concerns interoperability constituents which are subject to ~~EC~~-type examination (~~module CB~~), or design examination (~~module CH~~) or to suitability for use (~~module CV~~) in accordance with section 6.1 of this TSI.

- (2) The ~~EC~~-type or design examination or suitability for use ~~certificate is~~ remains valid ~~for a ten year period even if a revision of this UTP or of the UTP Noise comes into force, unless explicitly otherwise specified in the revision of those UTPs.~~

During this time, new constituents of the same type are permitted ~~to be placed on the market without a new type assessment, unless explicitly otherwise specified in the revision of this TSI. Before the end of the ten year period, the constituent shall be assessed according to the latest revision of this TSI in force at that time, for those requirements that have changed or are new in comparison to the certification basis:~~

to be used in vehicles

to be placed on the market

without a new type assessment.

 OTIF	Uniform Technical Prescription (UTP)			UTP WAG
	ROLLING STOCK - FREIGHT WAGONS			Page 80 of 148
Status: DRAFT	Version 1	TECH-23020	Original: EN	Date: 17.5.2023

7.3 Specific cases

7.3.1 Introduction

The specific cases, as listed in point 7.3.2, are classified as:

- “P” cases: “permanent” cases.
- “T0”: “temporary” cases of indefinite duration, where the target system shall be reached by a date still to be determined.
- “T2” cases: “temporary” cases, where ~~that~~ the target system shall be reached by 31 December 2023⁵.

All specific cases and their relevant dates shall be re-examined in the course of future revisions of the TSI with a view to limiting their technical and geographical scope based on an assessment of their impact on safety, interoperability, cross border services, TEN-T corridors, and the practical and economic impacts of retaining or eliminating them. Special account shall be given to availability of EU funding.

Specific cases shall be limited to the route or network where they are strictly necessary and taken account of through route compatibility procedures.

In case of a specific case applicable to a component defined as interoperability constituent in section 5.3 of this TSI, the conformity assessment has to be performed according to point 6.1.2.

7.3.2 List of specific cases

Specific cases for Contracting States which are also EU Member States are those which are included in the WAG TSI.

This section sets out specific cases which apply to the Great Britain⁵⁸ network of the United Kingdom.

~~The specific cases for the Great Britain network of the United Kingdom have been taken over from the WAG TSI.~~

(see section 7.3.2 of WAG TSI)

⁵⁸ Specific cases which apply on the Northern-Ireland network of the United Kingdom and are set out in the TSI, as these are harmonised with the network of the Republic of Ireland. Specific cases which apply for the Channel Tunnel are set out in the TSI.

 OTIF	Uniform Technical Prescription (UTP)			UTP WAG
	ROLLING STOCK - FREIGHT WAGONS			Page 81 of 148
Status: DRAFT	Version 1	TECH-23020	Original: EN	Date: 17.5.2023

Specific cases which apply only to domestic traffic on the Great Britain network of the United Kingdom are reproduced in the right hand column⁵⁹.

~~7.3.2.1 Safety against derailment running on twisted track (point 4.2.3.5.1)~~

~~**Specific Case United Kingdom (for Great Britain) (“P”)**~~

~~The limitations to the use of Method 3 set out in EN 14363:2016 clause 6.1.5.3.1 are not applicable for units that are intended for national use on the UK mainline network only.~~

~~This specific case does not prevent the access of TSI compliant rolling stock to the national network.~~

~~7.3.2.2~~ 7.3.2.1 Running dynamic behaviour (point 4.2.3.5.2)

~~**Specific Case United Kingdom (for Great Britain) (“P”)**~~

~~Base condition for use of simplified measuring method specified in EN 14363:2016 clause 7.2.2 should be extended to nominal static vertical wheelset forces (PF0) up to 250 kN. For technical compatibility with the existing network it is permissible to use national technical rules amending EN 14363:2016 and notified for the purpose of running dynamic behaviour.~~

~~This specific case does not prevent the access of UTP compliant rolling stock to the national network.~~

Specific Case United Kingdom (for Great Britain) (“P”)

The base condition for use of simplified measuring method specified in EN 14363:2016 clause 7.2.2 should be extended to nominal static vertical wheelset forces (PF0) up to 250 kN. For technical compatibility with the existing network, it is permissible to use national technical rules amending EN 14363:2016 and notified for the purpose of running dynamic behaviour.

This specific case does not prevent the access of UTP compliant rolling stock to the national network.

~~7.3.2.3~~ 7.3.2.2 Characteristics of wheelsets, wheels and axles (points 4.2.3.6.2 and 4.2.3.6.3)

~~**Specific Case United Kingdom (for Great Britain) (“P”)**~~

~~For units intended to operate solely on the railway network of Great Britain the characteristics of the wheelsets, wheels and axles may be in accordance with the national technical rules notified for this purpose.~~

⁵⁹ Specific cases relevant for vehicles exclusively used in domestic traffic are not within the scope of the UTP.

 OTIF	Uniform Technical Prescription (UTP)			UTP WAG
	ROLLING STOCK - FREIGHT WAGONS			Page 82 of 148
Status: DRAFT	Version 1	TECH-23020	Original: EN	Date: 17.5.2023

~~This specific case does not prevent the access of UTP compliant rolling stock to the national network.~~

Specific Case United Kingdom (for Great Britain) (“P”)

For units intended to operate solely on the railway network of Great Britain, the characteristics of the wheelsets, wheels and axles may be in accordance with the national technical rules notified for this purpose.

This specific case does not prevent the access of UTP compliant rolling stock to the national network.

~~7.3.2.4~~7.3.2.3 Rules to manage changes in both rolling stock and rolling stock type (7.2.2.2)

~~**Specific Case United Kingdom (for Great Britain) (“P”)**~~

~~Any change to a vehicle swept envelope as defined in the national technical requirements notified for the gauging process (for example as described in RIS 2773 RST) will be categorised as 15(1)(c) of Implementing Regulation (EU) 2018/545, and will not be classified as 21(12)(a) of Directive (EU) 2016/797.~~

Specific Case United Kingdom (for Great Britain) (“P”)

Any change to a vehicle swept envelope as defined in the national technical requirements notified for the gauging process (for example as described in RIS-2773-RST) will be categorised as 15(1)(c) of Implementing Regulation (EU) 2018/545, and will not be classified as 21(12)(a) of Directive (EU) 2016/797.

7.4 Specific environmental conditions

Specific environmental conditions for Contracting States which are also EU Member States are those which are included in the WAG TSI.

(see section 7.4 of WAG TSI)

7.5 Freight wagons operating under national, bilateral, multilateral or international agreements

Not applicable within the scope of this UTP.

(see section 7.5 of WAG TSI)

~~**7.6 Aspects that have to be considered in the revision process or in other activities of the Agency**~~

~~[Reserved]~~

~~Further to the analysis performed during the drafting process of this TSI, particular aspects have been identified as of interest for the future development of the EU railway system.~~

 OTIF	Uniform Technical Prescription (UTP)			UTP WAG
	ROLLING STOCK - FREIGHT WAGONS			Page 83 of 148
Status: DRAFT	Version 1	TECH-23020	Original: EN	Date: 17.5.2023

These aspects are identified below.

Rules for implementation

~~On 24 January 2020 the Commission sent a request to the European Union Agency for Railways for the preparation of the Digital rail and Green freight TSI revision package (2022 revision).~~

~~Pursuant to Commission Delegated Decision (EU) 2017/1474, the Digital rail and Green freight TSI revision package shall include provisions reviewing and if possible simplifying the strategy for the application of the TSIs in a way ensuring a gradual, but timely reduction of the divergences from the target system while providing the predictability and legal certainty necessary to the sector. These provision shall cover future transition periods as well as the issue of the validity period of the certificates for interoperability constituents and subsystems.~~

~~Furthermore, with the same objective of ensuring a gradual, but timely reduction of the divergences from the target system while providing the predictability and legal certainty necessary to the sector, provisions providing flexibility in the application of updated versions of standards shall be considered, including for those introduced in Annex I (WAG 2019 TSI) to Commission Implementing Regulation (EU) 2019/776⁶⁰.~~

⁶⁰ Commission Implementing Regulation (EU) 2019/776 of 16 May 2019 amending Commission Regulations (EU) No 321/2013, (EU) No 1299/2014, (EU) No 1301/2014, (EU) No 1302/2014, (EU) No 1303/2014 and (EU) 2016/919 and Commission Implementing Decision 2011/665/EU as regards the alignment with Directive (EU) 2016/797 of the European Parliament and of the Council and the implementation of specific objectives set out in Commission Delegated Decision (EU) 2017/1474

 OTIF	Uniform Technical Prescription (UTP)		UTP WAG	
	ROLLING STOCK - FREIGHT WAGONS		Page 84 of 148	
Status: DRAFT	Version 1	TECH-23020	Original: EN	Date: 17.5.2023

Appendix A: Changes of requirements and transition regimes

Not used.

For UTP points other than those listed in Table A.1 and Table A.2,

With the exception of the points listed in Table A.1 and Table A.2, compliance with the UTP WAG 2022 is deemed as compliance with this UTP.

compliance with the ‘previous TSI’ (i.e. this Regulation⁶¹, as amended by Commission Implementing Regulation (EU) 2020/387⁶²) imply compliance with this TSI applicable from [Publications Office: please insert the date of entry into force of this amending act].

Changes with a generic transition regime of 7 years:

For UTP points listed in Table A.1,

With regard to the points listed in Table A.1, compliance with the UTP WAG 2022 (or any previous version) does not constitute compliance with this UTP.

compliance with the previous TSI does not imply compliance with the version of this TSI applicable from [Publications Office: please insert the date of entry into force of this amending act].

Projects that were already in their design phase on [1 January 2024] shall comply with the requirements of this UTP from [insert EU date...].

Projects already in design phase on [Publications Office: please insert the date of entry into force of this amending act] shall comply with the requirement of this TSI from [Publications Office: please insert the date of entry into force of this amending act + 7 years].

Projects in production phase and units in operation are not affected by the UTP requirements listed in Table A.1.

Projects in production phase and units in operation are not affected by the TSI requirements listed in Table A.1.

Table A.1 – transition regime of 7 years

<u>UTP point(s)</u>	<u>UTP point(s) in previous UTP</u>	<u>Explanation of the UTP change</u>
<u>4.2.2.3 Second paragraph</u>	<u>New requirement</u>	<u>Inclusion of a requirement on the securing devices</u>
<u>4.2.3.5.3 Derailment detection and prevention function</u>	<u>No point</u>	<u>Inclusion of requirements for the derailment detection and prevention function</u>

⁶¹ Commission Regulation (EU) No 321/2013 of 13 March 2013 concerning the technical specification for interoperability relating to the subsystem rolling stock — freight wagons

 OTIF	Uniform Technical Prescription (UTP)		UTP WAG	
	ROLLING STOCK - FREIGHT WAGONS		Page 85 of 148	
Status: DRAFT	Version 1	TECH-23020	Original: EN	Date: 17.5.2023

4.2.4.3.2.1 Service brake	4.2.4.3.2.1 Service brake	Evolution of the specification referenced in Appendix D.1, Indexes [16] and [17]
4.2.4.3.2.2 Parking brake	4.2.4.3.2.2 Parking brake	Evolution of the specification referenced in Appendix D.1 Index [17]
4.2.4.3.2.2 Parking brake	4.2.4.3.2.2 Parking brake	Change in the calculation of the parking brake parameters
6.2.2.8.1 Testing of barriers	6.2.2.8.1 Testing of barriers	Evolution of the specification referenced in Appendix D.1 Index [19]
7.1.2 (h) Marking of the parking brake	7.1.2 (h) Marking of the parking brake	Change in the required marking
Point 9 of Appendix C	Point 9 of Appendix C	Evolution of the specification referenced in Appendix D.1, Indexes [38], [39], [46], [48], [49], [58]
Points referring to Appendix H and Appendix D.2 index [B]	New requirement	Inclusion of requirements on the codification of units intended to be used in combined transport
Points referring to Appendix D.2 index [A] except to point 3.2.2	Points referring to ERA/ERTMS/033281 V4except to point 3.2.2	ERA/ERTMS/033281 V5 replaces ERA/ERTMS/033281 V4, main changes concern frequency management for interference current limits and closure of open points

Changes with a specific transition regime:

For TSI points listed in Table A.2,

With regard to the points listed in Table A.2, compliance with the UTP WAG 2022 does not constitute compliance with this UTP.

Projects already in design phase on [1 January 2024], projects in production phase, and units in operation shall comply with the requirement of this UTP in accordance with the respective transition regime set out in Table A.2 starting from [1 January 2024].

compliance with the previous TSI does not imply compliance with this TSI applicable from [Publications Office: please insert the date of entry into force of this amending act].

Projects already in design phase on [Publications Office: please insert the date of entry into force of this amending act], projects in production phase, and units in operation shall comply with the requirement of this TSI in accordance with the respective transition regime set out in Table A.2 starting from [Publications Office: please insert the date of entry into force of this amending act].

 OTIF	Uniform Technical Prescription (UTP)			UTP WAG
	ROLLING STOCK - FREIGHT WAGONS			Page 86 of 148
Status: DRAFT	Version 1	TECH-23020	Original: EN	Date: 17.5.2023

Table A.2 – Specific transition regime

<u>UTP point(s)</u>	<u>UTP point(s) in previous UTP</u>	<u>Explanation of UTP change</u>	<u>Transition regime</u>			
			<u>Design phase not started</u>	<u>Design phase started</u>	<u>Producti on phase</u>	<u>Units in operation</u>
<u>Points referring to point 3.2.2 Appendix D.2 Index [A]</u>	<u>Points referring to point 3.2.2 of ERA/ERTMS/0332 81 V4</u>	<u>ERA/ERTMS/033281 V5 replaces ERA/ERTMS/033281 V4</u>	<u>The transition regime for states that apply EU law is defined in Table B1 in Appendix B to the CCS TSI⁶³.</u>			

There is no OTIF specification for the Command-Control and Signalling (CCS) subsystem. This means that applicants seeking admission in states that do not apply EU law for wagons with electrical or electronic equipment on-board that might interfere with the CCS subsystem should ask the relevant competent authorities for advice on the applicable interface requirements.

Appendix B

Not used

⁶³ Table B1.1 in Appendix B to the CCS TSI concerns the Transition Regime for CCS On-Board Subsystem and Table B.1.2 concerns the Transition Regime for the RST Subsystem.

 OTIF	Uniform Technical Prescription (UTP)			UTP WAG
	ROLLING STOCK - FREIGHT WAGONS			Page 87 of 148
Status: DRAFT	Version 1	TECH-23020	Original: EN	Date: 17.5.2023

Appendix C: Additional optional conditions

The compliance with the following set of conditions C.1 to C.18-20 is optional. If the applicant selects this option, an aAssessing eEntity has to assess compliance within the UTP verification procedure.

1. Manual coupling system

The manual coupling system shall comply with the following requirements:

- The screw coupling system excluding the draw hook, and the draw hook itself, shall respectively comply with the requirements related to freight wagons—~~of EN15566:2009+A1:2010 except clause 4.4 defined in Appendix D Index [31]~~,
- The ~~draw hook~~wagon shall comply with the requirements related to freight wagons—~~of EN15566:2009+A1:2010 except clause 4.4 and except the dimension “a” in Annex A Figure A.1 which shall be treated as informative defined in Appendix D Index [59]~~.
- ~~The draw hook shall be located at a height between 920 and 1045 mm above rail level in all loading and wear conditions.~~
- ~~The centreline of the draw hook shall be located within a range of 0 to 20mm below the buffing centre.~~
- ~~The clearance for the draw hook shall be in accordance with clause 6.3.2 of EN 16116-2:2013.~~
- The buffer shall comply with the requirements related to freight wagons—~~of EN15551:2009+A1:2010 defined in Appendix D Index [32]~~.
- ~~The buffing centre line shall be located at a height between 940 and 1065 mm above rail level in all loading and wear conditions.~~
- ~~There shall be no fixed parts within 40 mm of a vertical plane placed at the end of the fully compressed buffers.~~
- ~~The space for shunting staff operation shall be in accordance with clause 6.2.1 of EN 16116-2:2013. For manual coupling systems equipped with 550 mm wide buffers the calculation of the free space may be done considering that the coupling gear components are lateral centrally positioned (D = 0 mm as defined in Annex A of EN 16116-2:2013).~~

Where a combined automatic and screw coupler is fitted, it is permissible for the auto coupler head to infringe the space ~~specified above~~ for shunting staff on the left hand side when it is stowed and the screw coupler is in use. In this case the marking ~~in figure 75 of EN15877-1:2012 defined in the specification referenced in Appendix D Index [2]~~ is mandatory.

~~Interaction of buffers and draw gear:~~

~~The characteristics of the buffers and draw gear shall be designed in order to enable the safe transit of curves in the track with a radius of 150 m. Two units with bogies coupled on straight track with touching buffers shall generate compressive forces not higher than 250 kN on a 150 m radius curve. There is no requirement specified for two axle units.~~

~~The distance between the front edge of a draw hook opening and the front side of the fully extended buffers shall be 355 mm +45/ -20 mm in the new condition as shown in Figure C.1:~~

 OTIF	Uniform Technical Prescription (UTP)			UTP WAG
	ROLLING STOCK - FREIGHT WAGONS			Page 88 of 148
Status: DRAFT	Version 1	TECH-23020	Original: EN	Date: 17.5.2023

Fig. C.1 Configuration of buffers and draw gear

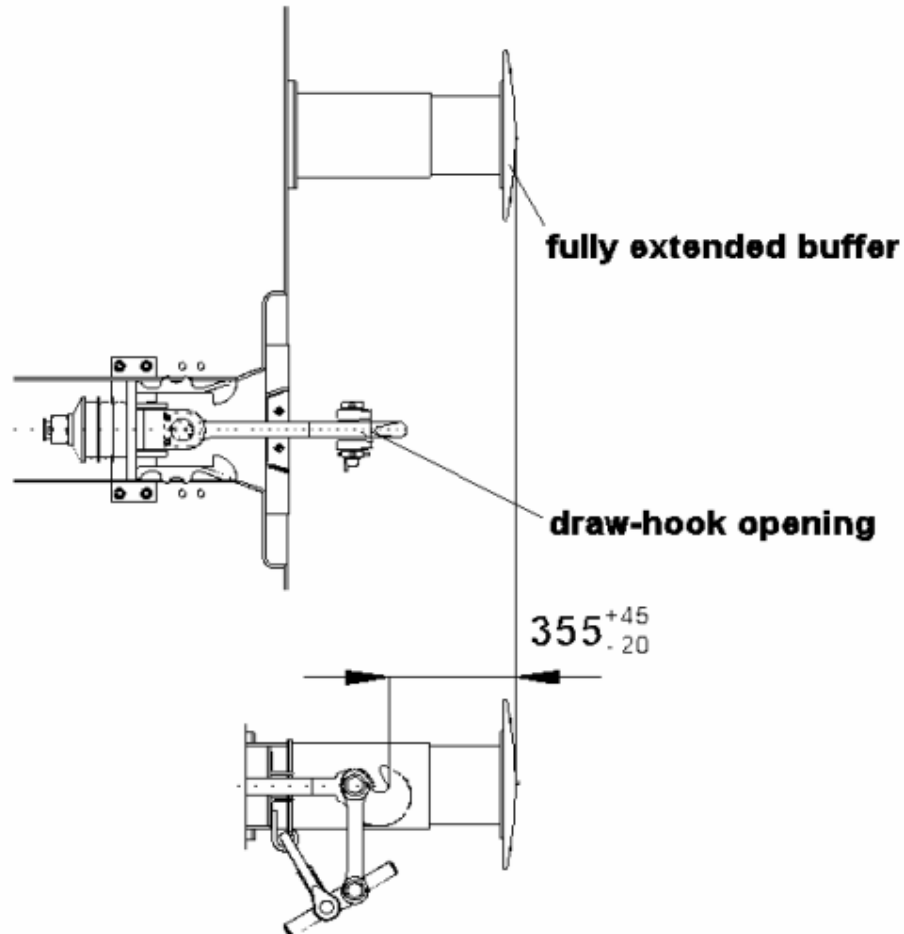

Units designed for 1435 mm and 1520 mm or 1435 mm and 1524 mm, or 1435 mm and 1668 mm gauge network(s), equipped with manual coupling and “UIC” pneumatic brake system, shall be compatible with both;

- the interface requirements for “End Coupling” mentioned before, and
- specific buffer layouts related to broad gauge networks.

In order to provide this full compatibility, it is permitted to have a different value of the distance between buffer centrelines, 1790 mm (Finland) and 1850 mm (Portugal and Spain) taking into account ~~clause 6.2.3.1 of EN 15551:2009+A1:2010~~ [the specification referenced in Appendix D Index \[32\]](#).

2. UIC footsteps and handrails

The unit shall be equipped with footsteps and handrails in accordance with ~~chapters 4 and 5 of EN 16116-2:2013~~ [the specification referenced in Appendix D Index \[28\]](#) and with clearances in accordance with ~~clause 6.2.2 of EN 16116-2:2013~~ [the same specification](#).

 OTIF	Uniform Technical Prescription (UTP)			UTP WAG
	ROLLING STOCK - FREIGHT WAGONS			Page 89 of 148
Status: DRAFT	Version 1	TECH-23020	Original: EN	Date: 17.5.2023

3. Ability to be hump shunted

In addition to the requirements of point 4.2.2.2 the unit shall be assessed in accordance with ~~clause 8 of EN 12663-2:2010~~ [the specification referenced in Appendix D Index \[1\]](#) and classified in Category F-I in accordance with ~~clause 5.1 of EN 12663-2:2010~~ [the same specification](#) with the following exception: for units designed to carry motor vehicles or combined transport units without long stroke shock absorbers the Category F-II may be used. The requirements concerning the buffing tests in ~~clause 8.2.5.1 of EN 12663-2:2010~~ [the same specification](#) apply.

4. Free space under lifting points

The unit shall comply with figure C.2 on the free space under the re-railing places for rerailing:

Fig. C.2 Free spaces under rerailing places

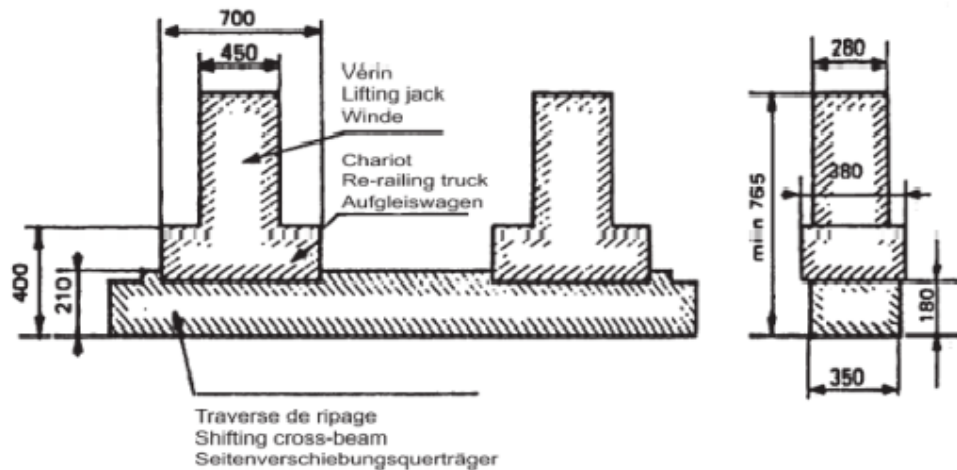

5. Marking of units

Units compliant with all requirements set out in section 4.2, fulfilling all conditions set out in point 7.1.2 and all conditions set out in Appendix C may receive the marking “GE”.

Wagons of the existing fleet which have been authorised in the EU in accordance with

- Commission Decision 2006/861/EC as amended by Decision 2009/107/EC or with
- Decision 2006/861/EC as amended by Decisions 2009/107/EC and 2012/464/EU and meeting the conditions set out in point 7.6.4 of Decision 2009/107/EC,

(64)

(c) with regards to the marking “GE” as depicted in point 5 of Appendix C of the Annex, wagons of the existing fleet which have been authorised in accordance with Commission Decision 2006/861/EC as amended by Decision 2009/107/EC or with Decision 2006/861/EC as amended by Decisions 2009/107/EC and 2012/464/EU and meeting the conditions set out in point 7.6.4 of Decision 2009/107/EC may

⁶⁴ Article 3(c) of Commission Regulation (EU) No 321/2013 enacting the WAG TSI as last amended by Commission Implementing Regulation (EU) 2020/387 of 9 March 2020.

 OTIF	Uniform Technical Prescription (UTP)			UTP WAG
	ROLLING STOCK - FREIGHT WAGONS			Page 90 of 148
Status: DRAFT	Version 1	TECH-23020	Original: EN	Date: 17.5.2023

Or which have been admitted to operation in accordance with

- UTP WAG with reference A 94-02/3.2011 of 1.12.2012 and meeting the conditions set out in point 7.6.4 of that UTP,

may receive this marking “GE” without any additional third party assessment or new admission to operation. The use of this marking on wagons in operation remains under the responsibility of the railway undertakings.

receive this marking “GE” without any additional third party assessment or new authorisation for placing on the market. The use of this marking in wagons in operation remains under the responsibility of the railway undertakings.

Units compliant with all requirements set out in section 4.2, fulfilling all conditions in point 7.1.2 and the conditions set out in Appendix C but not those set out in Appendix C sections 3 and/or 6 and/or 7.b may receive the marking “CW”.

If the additional marking is used, it shall be inscribed on the unit as outlined in figure C.3.

Fig. C.3 The additional markings “GE” and “CW”



The letters shall be of the same font type as the TEN marking. The size of the letters shall be at least 100 mm high. The outer measures of the frame shall be at least 275 mm wide and 140 mm high, the frame shall be 7 mm thick.

The marking shall be located on the right hand side of the area containing the European Vehicle Number and the TEN marking.

6. G1 gauge

The reference contour with which the unit complies with shall be G1 and G11 determined as defined in point 4.2.3.1.

7. Compliance with core UTP/TSI regarding train detection systems

- The unit shall be compatible with the train detection systems based on track circuits, on axle counters and on loop equipment as specified in

 OTIF	Uniform Technical Prescription (UTP)			UTP WAG
	ROLLING STOCK - FREIGHT WAGONS			Page 91 of 148
Status: DRAFT	Version 1	TECH-23020	Original: EN	Date: 17.5.2023

section 7.1.2 (h), with the values as defined in Appendix ~~H~~[D.2 Index \[A\]](#).⁶⁵ clauses 4.2.3.3(a), 4.2.3.3(b) and 4.2.3.3(c).

(b) The distance between two adjacent axles of the unit shall not exceed 17500 mm.

(c) If the unit has electronic equipment on board emitting interference current via the rail, the 'influencing unit' (as defined in the technical document referenced in Appendix D.2 Index [A]) of which the unit is planned to be part shall be compliant with

track circuits requirements captured in coordination with the authorities competent for the area of use of the unit

specific cases for track circuits notified under Article 13 of CCS TSI

by applying the harmonised vehicle test methods and vehicle impedance referred in the technical document referenced in Appendix D.2 Index [A]. Compliance of the unit can be demonstrated based on the

same technical document and is assessed by the assessing entity as part of the UTP verification procedure.

technical document referred in Article 13 of CCS TSI and is checked by the Notified Body as part of EC verification.

(d) If the unit has electrical or electronic equipment on board emitting interference electromagnetic fields:

- close to the wheel sensor of an axle counter, or

- induced by the return current via the rail if applicable.-

The 'influencing unit' (as defined in the technical document referenced in Appendix D.2 Index [A]) of which the unit is planned to be part shall be compliant with

axle counters requirements captured in coordination with the authorities competent for the area of use of the unit

specific cases for axle counters notified under Article 13 of CCS TSI

by applying the harmonised vehicle test methods referred in the technical document referenced in appendix D.2 index [A]. Compliance of the unit can be demonstrated based on the

same technical document and is assessed by the assessing entity as part of the UTP verification procedure.

technical document referred in Article 13 of CCS TSI and is checked by the Notified Body as part of EC verification.

8. Tests concerning longitudinal compressive forces

The verification of safe running under longitudinal compressive forces shall be in accordance with ~~EN 15839:2012+A1:2015~~ [the specification referenced in Appendix D Index \[33\]](#).

9. UIC brake

The brake system shall be compatible with vehicles equipped with UIC approved brake systems. The brake system of a unit is compatible with the UIC brake system if it fulfils the following requirements:

⁶⁵ According to clause 7.1.2 and Appendix ~~H~~[D.2 Index \[A\]](#), the distance between two adjacent axles shall not exceed 20000 mm and CW wagons must comply with this value. For wagons marked GE, this value in clause 7.1.2 and Appendix ~~H~~[D.2 Index \[A\]](#) is made stricter by the maximum value 17500 mm, as set out in point (b).

 OTIF	Uniform Technical Prescription (UTP)			UTP WAG
	ROLLING STOCK - FREIGHT WAGONS			Page 92 of 148
Status: DRAFT	Version 1	TECH-23020	Original: EN	Date: 17.5.2023

- (a) The unit shall be equipped with a pneumatic brake pipe with an inner diameter of 32 mm.
- (b) Brake modes have different brake application and release times and specific brake weight percentage.
- (c) Every unit shall be fitted with a brake system having at least brake modes G and P. The brake modes G and P shall be assessed in accordance with ~~UIC 540:2014~~ [the specification referenced in Appendix D Index \[36\]](#).
- (d) The minimum braking performance for brake-modes G and P shall be in accordance with table C.3.
- (e) If a unit is equipped with a brake system having in addition further brake modes the assessment procedure as described in point 4.2.4.3.2.1 shall be carried out for these additional brake modes. The brake application time of the P brake mode in accordance with ~~UIC 540:2014~~ [the specification referenced in Appendix D Index \[36\]](#) are also valid for further brake modes.
- (f) The energy storage has to be designed in such way that after a brake application with the maximum brake cylinder pressure and the maximum unit specific brake cylinder stroke at any load state the pressure in the auxiliary reservoir must be at least 0,3 bar more than the brake cylinder pressure without the addition of any further energy. Details for standardised air reservoirs are set out in ~~EN 286 3:1994 (steel) and EN 286 4:1994 (aluminium)~~ [the specifications referenced in Appendix D Index \[40\] and Index \[41\]](#).
- (g) The pneumatic energy of the brake system shall not be used for other applications different than those related to braking purposes.
- (h) The distributor and distributor isolating device shall be in accordance with ~~EN 15355:2008+A1:2010~~ [the specification referenced in Appendix D Index \[34\]](#). At least one distributor shall be installed per 31m unit length.
- (i) The pneumatic half coupling and its hose:
 - (i) The interface of the brake pipe shall be in accordance with ~~EN 15807:2011~~ [the specification referenced in Appendix D Index \[42\]](#).
 - (ii) The opening of the automatic air brake coupling head shall face the left when looking at the end of the vehicle.
 - (iii) The opening of the main reservoir coupling head shall face the right when looking at the end of the unit.
 - (iv) The end cocks shall be in accordance with ~~EN 14601:2005+A1:2010~~ [the specification referenced in Appendix D Index \[43\]](#).
- (j) The brake mode switching device shall be in accordance with ~~UIC 541 1:2010 Appendix E~~ [the specification referenced in Appendix D Index \[44\]](#).
- (k) Brake block holders shall be in accordance with ~~UIC 542:2015~~ [the specification referenced in Appendix D Index \[45\]](#).
- (l) If the brake system requires a “friction element for wheel tread brakes” interoperability constituent, the interoperability constituent shall, in addition to the requirements of point 6.1.2.5, comply with ~~UIC leaflet 541 4:2010. The manufacturer of the friction element for wheel tread brakes, or his authorised representative established within the Union, shall in that case obtain the UIC approval~~ [the specification referenced in Appendix D Index \[46\] or Index \[47\]](#).

 OTIF	Uniform Technical Prescription (UTP)			UTP WAG
	ROLLING STOCK - FREIGHT WAGONS			Page 93 of 148
Status: DRAFT	Version 1	TECH-23020	Original: EN	Date: 17.5.2023

- (m) Slack adjusters shall be in accordance with ~~chapters 4 and 5 of EN 16241:2014~~ [specification referenced in Appendix D Index \[48\]](#). The assessment of conformity shall be carried out in accordance with ~~clauses 6.3.2 to 6.3.5 of EN 16241:2014~~ [the same specification](#). Additionally, a life test shall be performed to demonstrate the suitability of the slack adjuster for service on the unit and to verify the maintenance requirements for the operational design life. This shall be carried out at the maximum rated load cycling through the full range of adjustment.
- (n) If the unit is equipped with a wheel slide protection system (WSP) it shall be in accordance with ~~EN 15595:2009+A1:2011~~ [the specification referenced in Appendix D Index \[49\]](#).
- ~~(n)~~(o) [For wagons with composite brake blocks and a nominal wheel diameter of max 1000 mm, minimal worn 840 mm and a braked weight per wheelset of more than 15.25 t \(14.5 t plus 5%\), a relay valve type E in accordance with the specification referenced in Appendix D Index \[35\] shall be used. For wagons with a nominal wheel diameter smaller than 920 mm, this brake weight limit value shall be adapted in line with the energy input into the wheel rim.](#)



 OTIF	Uniform Technical Prescription (UTP)			UTP WAG
	ROLLING STOCK - FREIGHT WAGONS			Page 94 of 148
Status: DRAFT	Version 1	TECH-23020	Original: EN	Date: 17.5.2023

Table C.3 Minimum braking performance for brake modes G and P

Braking mode	Command Equipment	unit type	Load status	Requirement for running speed at 100 km/h		Requirement for running speed at 120 km/h	
				Maximum braking distance	Minimum braking distance	Maximum braking distance	Minimum braking distance
Braking mode "P"	Changeover ^(4.1)	"S1" ⁽²⁾	Empty	$S_{max} = 700_m$ $\lambda_{min} = 65\%_{-f(4)}$ $a_{min} = 0,60_m/s^2_{(4)}$	$S_{min} = 390_m$, $\lambda_{max} = 125\%$, $(130\%)_{(3)}$, $a_{max} = 1,15_m/s^2$	$S_{max} = 700_m$ $\lambda_{min} = 100\%$ $a_{min} = 0,88_m/s^2$	$S_{min} = 580_m$, $\lambda_{max} = 125\%$, $(130\%)_{(3)}$, $a_{max} = 1,08m/s^2$
			Inter-mediate	$S_{max} = 810_m$ $\lambda_{min} = 55\%$ $a_{min} = 0,51_m/s^2$	$S_{min} = 390_m$, $\lambda_{max} = 125\%$, $a_{max} = 1,15_m/s^2$		
			Loaded	$S_{max} = 700_m$ $\lambda_{min} = 65\%$ $a_{min} = 0,60_m/s^2$	$S_{min} = \text{Max} [(S = 480_m$, $\lambda_{max} = 100\%$, $a_{max} = -0,91_m/s^2)$, (S obtained with a mean retardation force of 16,5 kN per axle)] ^(5.4) .		
	Variable load Relay ^(4.5)	"SS", "S2"	Empty	$S_{max} = 480_m$ $\lambda_{min} = 100\%$ ^(4.6) $a_{min} = 0,91_m/s^2$ ^(4.6)	$S_{min} = 390_m$, $\lambda_{max} = 125\%$, $(130\%)_{(1)}$, $a_{max} = 1,15_m/s^2$	$S_{max} = 700_m$ $\lambda_{min} = 100\%$ $a_{min} = 0,88_m/s^2$	$S_{min} = 580_m$, $\lambda_{max} = 125\%$, $(130\%)_{(1)}$, $a_{max} = 1,08_m/s^2$
			Loaded	$S_{max} = 700_m$ $\lambda_{min} = 65\%$ $a_{min} = 0,60_m/s^2$	$S_{min} = \text{Max} [(S = 480_m$, $\lambda_{max} = 100\%$, $a_{max} = 0,91_m/s^2)$, (S obtained with a mean retardation force of 16,5 kN per axle)] ^(6.8) .		
		"SS" ^(4.7)	Loaded (18 t per axle for brake blocks)			$S_{max}^{(10)} = \text{Max} [S = 700_m$, $\lambda_{max} = 100\%$, $a_{max} = 0,88_m/s^2)$, (S obtained with a mean retardation force of 16kN per axle)] ^(7.11) .	
Braking mode "G"				There shall be no separate assessment of the braking performance of units in position G. A unit's braked weight in position G is the result of the braked weight in position P (see UIC 544-1:2014 the specifications referenced in Appendix D, either Index [17] or Index [58])			

 OTIF	Uniform Technical Prescription (UTP)			UTP WAG
	ROLLING STOCK - FREIGHT WAGONS			Page 95 of 148
Status: DRAFT	Version 1	TECH-23020	Original: EN	Date: 17.5.2023

- ~~* only for two stage load brake (changeover command) and P10 (cast iron blocks with 10 % phosphor) or LL-brake blocks~~
- ~~(+) “a” = $((\text{Speed (Km/h)})/3,6)^2 / (2 \times S \cdot (T_e) \times (\text{Speed (Km/h)}/3,6))$, with $T_e = 2 \text{ sec}$. Distance calculation EN 14531 1:2015 section 4~~
- ~~(2) a unit “S1” is a unit with empty/load device. Maximum load per axle is 22,5 t.~~
- ~~(3) a unit “S2” is a unit with a variable load relay. Maximum load per axle is 22,5 t.~~
- ~~(4) a unit “SS” shall be equipped with a variable load relay. Maximum load per axle is 22,5 t.~~
- ~~(5) The maximum mean retardation force admitted (for running speed at 100km/h) is $18 \times 0,91 = 16,5 \text{ kN/axle}$. This value comes from the maximum braking energy input permitted on a clasp braked wheel with a nominal new diameter in the range of [920 mm; 1 000 mm] during braking (the brake weight shall be limited to 18 tonnes/axle).~~
- ~~(6) The maximum mean retardation force admitted (for running speed at 100km/h) is $18 \times 0,91 = 16,5 \text{ kN/axle}$. This value comes from the maximum braking energy input permitted on a clasp braked wheel with a nominal new diameter in the range of [920 mm; 1 000 mm] during braking (the brake weight shall be limited to 18 tonnes/axle). Usually a unit, with $V_{\text{max}} = 100 \text{ km/h}$ and fitted with a variable relay is designed to obtain $\lambda = 100\%$ up to 14.5 t/axle.~~
- ~~(7) The maximum mean retardation force admitted (for running speed at 120km/h) is $18 \times 0,88 = 16 \text{ kN/axle}$. This value comes from the maximum braking energy input permitted on a clasp braked wheel with a nominal new diameter in the range of [920 mm; 1 000 mm] during braking (the brake weight shall be limited to 18 tonnes). The mass/axle is limited to 20 t/axle and the corresponding λ is 90%. If it is required $\lambda > 100\%$ with mass/axle $> 18 \text{ t}$ then it is necessary to consider another kind of brake.~~
- ~~(8) λ must not exceed 125%, considering for brake only on wheels (brake blocks), the maximum mean retardation force admitted of 16 kN/axle (for running speed at 120km/h).~~
- ~~(9) Changeover in accordance with EN 15624:2008+A1:2010.~~
- ~~(10)(1) Variable load relay in accordance with EN 15611:2008+A1:2010 in combination with variable load sensing device in accordance with EN 15625:2008+A1:2010. Changeover in accordance with the specification referenced in Appendix D Index [38].~~
- (2) An “S1” unit is a unit with empty/load device. Maximum load per axle is 22,5 t.
- (3) Only for two stage load brake (changeover command) and P10 (cast iron blocks with 10 % phosphor)- or LL-brake blocks.
- (4) The maximum mean retardation force allowed (for running speed at 100 km/h) is $18 \times 0,91 = 16,5 \text{ kN/axle}$. This value comes from the maximum braking energy input permitted on a clasp braked wheel with a nominal new diameter in the range of [920 mm; 1000 mm] during braking (the brake weight shall be limited to 18 tonnes/axle).
- (5) Variable load relay in accordance with the specification referenced in Appendix D Index [35] in combination with a variable load sensing device in accordance with the specification referenced in Appendix D Index [39].
- (6) “a” = $((\text{Speed (km/h)})/3,6)^2 / (2 \times S \cdot (T_e) \times (\text{Speed (km/h)}/3,6))$, with $T_e = 2 \text{ sec}$. Distance calculation in accordance with the specification referenced in Appendix D Index [16].
- (7) An “S2” unit is a unit with a variable load relay. The maximum load per axle is 22,5 t.
- (8) The automatic-load controlled equipment of wagons worked under s conditions can provide a maximum braked weight of $\lambda = 100 \%$, up to load limit equal to 67 % of the maximum permissible wagon weight.
For standard wheelset ~~with~~ using the max. axle load:
- Max. 1000 mm; minimal worn 840 mm, max. axle load 22,5t,
Max. axle load for $\lambda=100$: 15 t
 - Max. 840 mm; minimal worn 760 mm, max. axle load 20 t,
Max. axle load for $\lambda=100$: 13 t
 - Max. 760 mm; minimal worn 680 mm, max. axle load 18 t,
Max. axle load for $\lambda=100$: 12 t

 OTIF	Uniform Technical Prescription (UTP)			UTP WAG
	ROLLING STOCK - FREIGHT WAGONS			Page 96 of 148
Status: DRAFT	Version 1	TECH-23020	Original: EN	Date: 17.5.2023

- [Max. 680 mm; minimal worn 620 mm, max. axle load 16 t, Max. axle load for \$\lambda=100\$: 10,5 t](#)

⁽⁹⁾ [An 'SS' unit shall be equipped with a variable load relay. The maximum load per axle is 22,5 t.](#)

⁽¹⁰⁾ [\$\lambda\$ must not exceed 125 %, considering for braking only on wheels \(brake blocks\), the maximum mean retardation force allowed of 16 kN/axle \(for running speed at 120 km/h\).](#)

⁽¹¹⁾ [The requirement at a running speed of 120 km/h is to fulfil \$\lambda = 100\$ % up to the SS load limit, with following derogation: the mean retardation force for tread brake with wheel diameter \[new max. 1.000mm, worn min. 840 mm\] shall be limited to 16 kN/wheelset. This limit is caused by the maximum admissible braking energy corresponding to 20 t axle load with \$\lambda = 90\$ % and 18 t braked weight per wheelset.](#)

[If a braked weight percentage of more than 100 % is required with an axle load of more than 18 t, it is necessary to use another type of brake system \(for example disc brakes\) to limit the thermal load on the wheel.](#)

10. Location of parking brake handles

If a unit is equipped with a parking brake the location of its operating handle or operating wheel shall be:

- on both sides of the unit if it is operated from the ground or
- on a platform, that can be accessed from both sides of the unit.

The operation from the ground shall be done by wheel.

11. Temperature ranges for air reservoirs, hoses and grease

The following requirements are deemed to comply with any temperature range indicated in point 4.2.5.

- Air reservoirs shall be designed for the temperature range of -40°C to +70°C.
- Brake cylinders and brake couplings shall be designed for the temperature range of -40°C to +70°C.
- Hoses for air brakes and air supply shall be specified for the temperature range -40°C to +70°C.

The following requirement is deemed to comply with the range T1 indicated in point 4.2.5:

- The grease for the lubrication of roller bearing shall be specified for ambient temperatures down to -20°C.

12. Welding

Welding shall be carried out in accordance with ~~EN 15085-1:2007+A1:2013, EN 15085-2:2007, EN 15085-3:2007, EN 15085-4:2007 and EN 15085-5:2007~~ [the specifications referenced in Appendix D Indexes \[50\] to \[54\]](#).

13. Track gauge

The unit shall be compatible with the 1435 mm track gauge.

14. Specific brake thermal capacity

The brake system shall resist a thermal load equivalent to the suggested reference case in point 4.2.4.3.3.

With regard to the use of wheel tread brake systems this condition is deemed to be met, if the “friction elements for wheel tread brakes” interoperability constituent is, in addition to the requirements of point

 OTIF	Uniform Technical Prescription (UTP)			UTP WAG
	ROLLING STOCK - FREIGHT WAGONS			Page 97 of 148
Status: DRAFT	Version 1	TECH-23020	Original: EN	Date: 17.5.2023

6.1.2.5, compliant with ~~UIC leaflet 541-4:2010~~ [the specification referenced in Appendix D, either Index \[46\] or Index \[47\]](#), and if the wheel:

- is assessed in accordance with point 6.1.2.3 and
- fulfils the conditions of Section 15 of Appendix C.

15. Specific product properties concerning the wheel

The wheels shall be in accordance with ~~EN 13262: 2004+A1:2008+A2:2011 and EN 13979-1:2003+A1:2009+A2:2011~~ [the specification referenced in Appendix D Index \[55\]](#). The thermal mechanical type test required in point 6.1.2.3 shall be carried out in accordance with ~~table C.4~~ [the specification referenced in Appendix D Index \[11\]](#) when the complete brake system is acting directly on the wheel tread.

Table C.4 Conditions for the thermal mechanical type test

Wheel diameter range [mm]	1000–920	920–840	840–760	760–680
Standard power value	50 kW	50 kW	42,5 kW	38 kW
Application time	45 min	45 min	45 min	45 min
Running speed	60 km/h	60 km/h	60 km/h	60 km/h

16. Tow hooks

Units shall be provided with tow hooks, each one being fixed to the side of the unit underframe in accordance with ~~clause 1.4 of UIC 535-2:2006~~ [the specification referenced in Appendix D Index \[56\]](#).

Alternative technical solutions are allowed as far as conditions ~~1.4.2 to 1.4.9 of UIC 535-2:2006~~ [listed in the same specification](#) are respected. If the alternative solution is a cable eye bracket, it shall in addition have a minimum diameter of 85 mm.

17. Protective devices on protruding parts

To ensure the safety of staff, protruding (e.g. angular or pointed) parts of the unit located up to 2 m above rail level or above passageways, working surfaces or tow hooks which are liable to cause accidents, shall be fitted with protective devices as described in ~~clause 1.3 of UIC 535-2:2006~~ [the specification referenced in Appendix D Index \[56\]](#).

18. Label holders and attachment devices for rear-end signal

All units shall be equipped with a label holder in accordance with ~~clause 1 of UIC 575:1995~~ [the specification referenced in Appendix D Index \[57\]](#) and at both ends with attachment devices as set out in point 4.2.6.3.

 OTIF	Uniform Technical Prescription (UTP)			UTP WAG
	ROLLING STOCK - FREIGHT WAGONS			Page 98 of 148
Status: DRAFT	Version 1	TECH-23020	Original: EN	Date: 17.5.2023

19. Axle bearing condition monitoring

It shall be possible to monitor the axle bearing condition of the unit by means of line side detection equipment.

20. Running dynamic behaviour

The combination of maximum operating speed and maximum admissible cant deficiency shall be ~~as shown in table H.1 of EN 14363:2016~~ in accordance with the specification referenced in Appendix D Index [7].

Units equipped with established running gear as ~~described~~ specified in ~~chapter 6 of EN 16235:2013~~ point 6.1.2.1 are presumed to be in conformity with this requirement.

 OTIF	Uniform Technical Prescription (UTP)			UTP WAG
	ROLLING STOCK - FREIGHT WAGONS			Page 99 of 148
Status: DRAFT	Version 1	TECH-23020	Original: EN	Date: 17.5.2023

Appendix D:

D.1 Mandatory standards or normative documents referred to in this UTP

UTP		Standard/document	
Characteristics to be assessed		References to Standard or document	Clauses
Structure and mechanical part	4.2.2		
Strength of unit	4.2.2.2	EN12663-2:2010	5
		EN-15877-1:2012	4.5.14
	6.2.2.1	EN-12663-1:2010+A1:2014	9.2
		EN-12663-2:2010	6,7
Gauging and track interaction	4.2.3		
Gauging	4.2.3.1	EN-15273-2:2013+A1:2016	all
Compatibility with load-carrying capacity of lines	4.2.3.2	EN-15528:2015	6.1, 6.2
Compatibility with train detection systems	4.2.3.3	ERA Technical document ERA/ERTMS/033281 rev.04 The relevant specifications in the scope of this UTP are included in Appendix H to this UTP	See Appendix H
Axle bearing condition monitoring	4.2.3.4	EN-15437-1:2009	5.1, 5.2
Safety against derailment running on twisted track	4.2.3.5.1	-	-
	6.2.2.2	EN-14363:2016	4, 5, 6.1
Running dynamic behaviour	4.2.3.5.2	EN-14363:2016	4, 5, 7
	6.1.2.1	EN-16235:2013	4, 5, 7
	6.2.2.3	EN-16235:2013	all
	6.1.2.1	EN-13749:2011	6.2
Structural design of bogie frame	4.2.3.6.1	EN-13749:2011	6.2
	6.1.2.1	EN-13749:2011	6.2
Characteristics of wheelsets	4.2.3.6.2	-	-
	6.1.2.2	EN-13260:2009+A1:2010	3.2.1
Characteristics of wheels	4.2.3.6.3	-	-
	6.1.2.3	EN-13979-1:2003+A1:2009+A2:2011	7, 6.2
Characteristics of axles	4.2.3.6.4	-	-
	6.1.2.4	EN-13103:2009+A2:2012	4, 5, 6, 7

 OTIF	Uniform Technical Prescription (UTP)		UTP WAG	
	ROLLING STOCK - FREIGHT WAGONS		Page 100 of 148	
Status: DRAFT	Version 1	TECH-23020	Original: EN	Date: 17.5.2023

UTP		Standard/document	
Characteristics to be assessed		References to Standard or document	Clauses
Axle boxes / bearings	4.2.3.6.5	-	-
	6.2.2.4	EN 12082:2007+A1:2010	6
Running gear for manual change of wheelsets	4.2.3.6.7	-	-
	6.2.2.5	UIC 430 1:2012 UIC 430 3:1995	Ann. B, H, I Ann. 7
Brake	4.2.4		
Service brake	4.2.4.3.2.1	EN 14531 6:2009	All
		UIC 544 1:2014	All
Parking brake	4.2.4.3.2.2	EN 14531 6:2009	6
Friction elements for wheel tread brakes	4.2.4.3.5	-	-
	6.1.2.5	ERA technical document ERA/TD/2013-02/INT version 3.0 of 27.11.2015	All
Environmental conditions	4.2.5		
Environmental conditions	4.2.5	EN 50125 1:2014	4.7
	6.2.2.7	-	-
System protection	4.2.6		
Barriers	4.2.6.1.2.1	-	-
	6.2.2.8.1	EN 1363 1:2012	All
Materials	4.2.6.1.2.2	-	-
	6.2.2.8.2	ISO 5658 2:2006/Am1:2011	All
		EN 13501 1:2007+A1:2009	All
		EN 45545 2:2013+A1:2015 ISO 5660 1:2015	Table 6 All
Cables	6.2.2.8.3	EN 50355:2013	All
		EN 50343:2014	All
Flammable liquids	6.2.2.8.4	EN 45545 7:2013	All
Protective measures against indirect contact (protective bonding)	4.2.6.2.1	EN 50153:2014	6.4
Protective measures against direct contact	4.2.6.2.2	EN 50153:2014	5
Attachment devices for rear end signals	4.2.6.3	EN 16116 2:2013	Figure 11

 OTIF	Uniform Technical Prescription (UTP)			UTP WAG
	ROLLING STOCK - FREIGHT WAGONS			Page 101 of 148
Status: DRAFT	Version 1	TECH-23020	Original: EN	Date: 17.5.2023

<u>Index</u>	<u>Standard name</u>	<u>Standard reference</u>	<u>Standard version</u>
	<u>Parameter</u>	<u>UTP Point</u>	<u>Standard Point</u>
[1]	<u>EN 12663-2:2010</u> <u>Railway applications - Structural requirements of railway vehicle bodies - Part 2: Freight wagons</u>		
[1.1]	<u>Strength of unit</u>	<u>4.2.2.2</u>	<u>5</u>
[1.2]	<u>Strength of unit – demonstration of conformity</u>	<u>6.2.2.1</u>	<u>6.7</u>
[1.3]	<u>Ability to be hump shunted</u>	<u>Appendix C, point 3</u>	<u>8</u>
[1.4]	<u>Classification</u>	<u>Appendix C, point 3</u>	<u>5.1</u>
[1.5]	<u>Requirements concerning the buffing tests</u>	<u>Appendix C, point 3</u>	<u>8.2.5.1</u>
[2]	<u>EN 15877-1:2012+A1:2018</u> <u>Railway applications - Marking on railway vehicles - Part 1: Freight wagons</u>		
[2.1]	<u>Lifting and jacking position marking</u>	<u>4.2.2.2</u>	<u>4.5.14</u>
[2.2]	<u>Marking of DDAF</u>	<u>4.2.3.5.3.4</u>	<u>4.5.59</u>
[2.3]	<u>Applicable markings</u>	<u>7.1.2 (g)</u>	<u>all points except 4.5.25(b)</u>
[2.4]	<u>Marking for combined automatic and screw coupler</u>	<u>Appendix C, point 1</u>	<u>Figure 75</u>
[3]	<u>EN 12663-1:2010+A1:2014</u> <u>Railway applications - Structural requirements of railway vehicle bodies - Part 1: Locomotives and passenger rolling stock (and alternative method for freight wagons)</u>		
[3.1]	<u>Strength of unit – demonstration of conformity</u>	<u>6.2.2.1</u>	<u>9.2, 9.3</u>
[3.2]	<u>Strength of unit - fatigue strength</u>	<u>6.2.2.1</u>	<u>5.6</u>
[4]	<u>EN 15273-2:2013+A1 :2016</u> <u>Railway applications - Gauges - Part 2: Rolling stock gauge</u>		
[4.1]	<u>Gauging</u>	<u>4.2.3.1</u>	<u>5, annexes A to J, L, M, P</u>
[5]	<u>EN 15528:2021</u> <u>Railway applications - Line categories for managing the interface between load limits of vehicles and infrastructure</u>		
[5.1]	<u>Compatibility with load carrying capacity of lines</u>	<u>4.2.3.2</u>	<u>6.1, 6.2</u>
[6]	<u>EN 15437-1:2009+A1:2022</u> <u>Railway applications – Axle box condition monitoring – Interface and design requirements - Part 1: Track side equipment and rolling stock axle box</u>		
[6.1]	<u>Axle bearing condition monitoring</u>	<u>4.2.3.4</u>	<u>5.1, 5.2</u>
[7]	<u>EN 14363:2016+A2:2022</u> <u>Railway applications - Testing and Simulation for the acceptance of running characteristics of railway vehicles - Running Behaviour and stationary tests</u>		

 OTIF	Uniform Technical Prescription (UTP)		UTP WAG
	ROLLING STOCK - FREIGHT WAGONS		Page 102 of 148
Status: DRAFT	Version 1	TECH-23020	Original: EN Date: 17.5.2023

<u>Index</u>	<u>Standard name</u>	<u>Standard reference</u>	<u>Standard version</u>
	<u>Parameter</u>	<u>UTP Point</u>	<u>Standard Point</u>
[7.1]	<u>Safety against derailment running on twisted track</u>	<u>6.2.2.2</u>	<u>4, 5, 6.1</u>
[7.2]	<u>Running dynamic behaviour</u>	<u>4.2.3.5.2</u>	<u>4, 5, 7</u>
[7.3]	<u>Running dynamic behaviour - On-track tests</u>	<u>6.2.2.3</u>	<u>4, 5, 7</u>
[7.4]	<u>Application to units operated on the 1668mm track gauge network</u>	<u>6.2.2.3</u>	<u>7.6.3.2.6 (2)</u>
[7.5]	<u>Running dynamic behaviour</u>	<u>C.20</u>	<u>Table H.1</u>
[8]	<u>EN 16235:2013</u> <u>Railway application - Testing for the acceptance of running characteristics of railway vehicles - Freight wagons - Conditions for dispensation of freight wagons with defined characteristics from on-track tests in accordance with EN 14363</u>		
[8.1]	<u>Running dynamic behaviour</u>	<u>6.1.2.1</u>	<u>5</u>
[8.2]	<u>Established running gear</u>	<u>6.1.2.1</u>	<u>6</u>
[8.3]	<u>Minimum axle load for established running gears</u>	<u>6.1.2.1</u>	<u>Table 7, 8, 10, 13, 16 and 19, in chapter 6</u>
[9]	<u>EN 13749:2021</u> <u>Railway applications - Wheelsets and bogies - Method of specifying the structural requirements of bogie frames</u>		
[9.1]	<u>Structural design of bogie frame</u>	<u>4.2.3.6.1</u>	<u>6.2</u>
[9.2]	<u>Assessment of the bogie frame strength</u>	<u>6.1.2.1</u>	<u>6.2</u>
[10]	<u>EN 13260:2020</u> <u>Railway applications - Wheelsets and bogies - Wheelsets - Product requirements</u>		
[10.1]	<u>Characteristics of wheelsets</u>	<u>6.1.2.2</u>	<u>4.2.1</u>
[11]	<u>EN 13979-1:2020</u> <u>Railway applications - Wheelsets and bogies - Monobloc wheels - Technical approval procedure - Part 1: Forged and rolled wheels</u>		
[11.1]	<u>Mechanical characteristics of wheels</u>	<u>6.1.2.3</u>	<u>8</u>
[11.2]	<u>Thermomechanical behaviour and criteria for residual stress</u>	<u>6.1.2.3</u>	<u>7</u>
[11.3]	<u>Specific product properties concerning the wheel</u>	<u>Appendix C, point 15</u>	<u>7</u>
[11.4]	<u>Specific product properties concerning the wheel - Thermomechanical type test</u>	<u>Appendix C, point 15</u>	<u>Table A.1</u>
[12]	<u>EN 13103-1:2017+A1:2022</u> <u>Railway applications - Wheelsets and bogies - Part 1: Design method for axles with external journals</u>		
[12.1]	<u>Method of verification</u>	<u>6.1.2.4</u>	<u>5, 6, 7</u>
[12.2]	<u>Decision criteria for permissible stress</u>	<u>6.1.2.4</u>	<u>8</u>

 OTIF	Uniform Technical Prescription (UTP)		UTP WAG
	ROLLING STOCK - FREIGHT WAGONS		Page 103 of 148
Status: DRAFT	Version 1	TECH-23020	Original: EN Date: 17.5.2023

<u>Index</u>	<u>Standard name</u>	<u>Standard reference</u>	<u>Standard version</u>
	Parameter	UTP Point	Standard Point
[13]	EN 12082:2017+A1:2021 Railway applications – Axle boxes - Performance testing		
[13.1]	Mechanical resistance and fatigue characteristics of the rolling bearing	6.2.2.4	7
[14]	UIC 430-1:2012 Conditions with which wagons must comply in order to be accepted for transit between standard gauge railways and the Spanish and Portuguese broad gauge railways		
[14.1]	Changeover between 1435 mm and 1668 mm track gauges, for axle units	6.2.2.5	Figures 9 and 10 of Annex B.4, and Figure 18 of Annex H
[14.2]	Changeover between 1435 mm and 1668 mm track gauges, for bogie units	6.2.2.5	Figure 18 of Annex H and Figures 19 and 20 of Annex I
[15]	UIC 430-3:1995 Goods wagons - Conditions to be satisfied by goods wagons to make them acceptable for running on both standard-gauge networks and the network of the Finnish state railways		
[15.1]	Changeover between 1435 mm and 1524 mm track gauges	6.2.2.5	Annex 7
[16]	EN 14531-1:2015+A1 :2018 Railway applications - Methods for calculation of stopping distances, slowing distances and immobilization braking - Part 1: General algorithms utilizing mean value calculation for train sets or single vehicles		
[16.1]	Service brake	4.2.4.3.2.1	4
[16.2]	Parking brake	4.2.4.3.2.2	5
[16.3]	Distance calculation	Appendix C, point 9, Table C.3	4
[17]	UIC 544-1:2014 Brakes - Braking performance		
[17.1]	Service brake - calculation	4.2.4.3.2.1	1 to 3 and 5 to 8
[17.2]	Service brake - validation	4.2.4.3.2.1	Appendix B
[17.3]	Assessment of braking mode G	C.9 - Table C.3	1 to 3 and 5 to 8
[18]	EN 50125-1:2014 Railway applications - Environmental conditions for equipment -Part 1: Rolling stock and on-board equipment		
[18.1]	Environmental conditions	4.2.5	4.7
[19]	EN 1363-1:2020 Fire resistance tests - Part 1: General Requirements		
[19.1]	Barriers	6.2.2.8.1	4 to 12

 OTIF	Uniform Technical Prescription (UTP)		UTP WAG	
	ROLLING STOCK - FREIGHT WAGONS		Page 104 of 148	
Status: DRAFT	Version 1	TECH-23020	Original: EN	Date: 17.5.2023

<u>Index</u>	<u>Standard name</u>	<u>Standard reference</u>	<u>Standard version</u>
	Parameter	UTP Point	Standard Point
[20]	ISO 5658- 2:2006/Am1:2011 Reaction to fire tests — Spread of flame — Part 2: Lateral spread on building and transport products in vertical configuration		
[20.1]	Testing of the materials ignitability and flame spread properties	6.2.2.8.2	5 to 13
[21]	EN 13501-1:2018 Fire classification of construction products and building elements - Part 1: Classification using data from reaction to fire tests		
[21.1]	Material properties	6.2.2.8.2	8
[22]	EN 45545-2:2020 Railway applications - Fire protection on railway vehicles -Part 2: Requirements for fire behaviour of materials and components		
[22.1]	Test conditions	6.2.2.8.2	Ref T03.02 of Table 6
[23]	ISO 5660-1:2015+Amd1:2019 Reaction-to-fire tests — Heat release, smoke production and mass loss rate —Part 1: Heat release rate (cone calorimeter method) and smoke production rate (dynamic measurement)		
[23.1]	Testing of rubber parts of bogies	6.2.2.8.2	5 to 13
[24]	EN 50355:2013 Railway applications - Railway rolling stock cables having special fire performance -Guide to use		
[24.1]	Cables	6.2.2.8.3	1, 4 to 9
[25]	EN 50343:2014/A1:2017 Railway applications -Rolling stock -Rules for installation of cabling		
[25.1]	Cables	6.2.2.8.3	1, 4 to 7
[26]	EN 45545-7:2013 Railway applications -Fire protection on railway vehicles -Part 7: Fire safety requirements for flammable liquid and flammable gas installations		
[26.1]	Flammable liquids	6.2.2.8.4	4 to 9
[27]	EN 50153:2014+A2:2020 Railway applications -Rolling stock -Protective provisions relating to electrical hazards		
[27.1]	Protective measures against indirect contact (protective bonding)	4.2.6.2.1	6.4
[27.2]	Protective measures against direct contact	4.2.6.2.2	5
[28]	EN 16116-2:2021 Railway applications - Design requirements for steps, handrails and associated access for staff - Part 2: Freight wagons		
[28.1]	Attachment devices for rear-end signal	4.2.6.3	Figure 10

 OTIF	Uniform Technical Prescription (UTP)		UTP WAG
	ROLLING STOCK - FREIGHT WAGONS		Page 105 of 148
Status: DRAFT	Version 1	TECH-23020	Original: EN Date: 17.5.2023

<u>Index</u>	<u>Standard name</u>	<u>Standard reference</u>	<u>Standard version</u>
	<u>Parameter</u>	<u>UTP Point</u>	<u>Standard Point</u>
[28.2]	<u>UIC footsteps and handrails</u> <u>Clearances</u>	<u>Appendix C, point 2</u>	<u>4, 5</u> <u>6,2</u>
[29]	<u>EN 15153-1:2020</u> <u>Railway applications -External visible and audible warning devices for trains -Part 1:</u> <u>Head, marker and tail lamps</u>		
[29.1]	<u>Rear-end signal - colour of tail lamps</u>	<u>Appendix E, point 1</u>	<u>5.5.3</u>
[29.2]	<u>Rear-end signal - lighting intensity of tail lamps</u>	<u>Appendix E, point 1</u>	<u>Table 8</u>
[30]	<u>EN 12899-1:2007</u> <u>Fixed, vertical road traffic signs - Part 1: Fixed signs</u>		
[30.1]	<u>Reflective plates</u>	<u>Appendix E, point 2</u>	<u>Class Ref. 2</u>
[31]	<u>EN 15566:2022</u> <u>Railway applications - Railway rolling stock - Draw gear and screw coupling</u>		
[31.1]	<u>Manual coupling system</u>	<u>Appendix C, point 1</u>	<u>4, 5, 6, 7 except</u> <u>clause 4.3 and the</u> <u>dimension 'a' in</u> <u>Annex B Figure</u> <u>B.1 which shall be</u> <u>treated as</u> <u>informative.</u>
[32]	<u>EN 15551:2022</u> <u>Railway applications - Railway rolling stock - Buffers</u>		
[32.1]	<u>Buffers</u>	<u>Appendix C, point 1</u>	<u>4 (except 4.3), 5, 6</u> <u>(except 6.2.2.3 and</u> <u>E.4), and 7</u>
[33]	<u>EN 15839:2012+A1:2015</u> <u>Railway applications - Testing for the acceptance of running characteristics of railway</u> <u>vehicles - Freight wagons - Testing of running safety under longitudinal compressive forces</u>		
[33.1]	<u>Tests concerning longitudinal compressive forces</u>	<u>Appendix C, point 8</u>	<u>All</u>
[34]	<u>EN 15355:2019</u> <u>Railway applications - Braking - Distributor valves and distributor-isolating devices</u>		
[34.1]	<u>Distributor and distributor isolating device</u>	<u>Appendix C, point</u> <u>9(h)</u>	<u>5, 6</u>
[35]	<u>EN 15611:2020+A1:2022</u> <u>Railway applications - Braking - Relay valves</u>		
[35.1]	<u>Variable load relay</u>	<u>Appendix C, point 9,</u> <u>Table C.3</u>	<u>5, 6, 7, 10</u>
[35.2]	<u>Type of relay valve</u>	<u>Appendix C, point</u> <u>9(o)</u>	<u>5, 6, 7, 10</u>
[36]	<u>UIC 540:2016</u> <u>Brakes - Air brakes for freight trains and passenger trains</u>		

 OTIF	Uniform Technical Prescription (UTP)		UTP WAG
	ROLLING STOCK - FREIGHT WAGONS		Page 106 of 148
Status: DRAFT	Version 1	TECH-23020	Original: EN Date: 17.5.2023

<u>Index</u>	<u>Standard name</u>	<u>Standard reference</u>	<u>Standard version</u>
	Parameter	UTP Point	Standard Point
[36.1]	UIC brake	Appendix C, points 9(c) and (e)	2
[37]	EN 14531-2:2015 Railway applications - Methods for calculation of stopping and slowing distances and immobilization braking - Part 2: Step by step calculations for train sets or single vehicles		
[37.1]	Service brake	4.2.4.3.2.1	4 & 5
[38]	EN 15624:2021 Railway applications - Braking - Empty-loaded changeover devices		
[38.1]	Changeover specification	Appendix C, point 9, Table C.3	4, 5, 8
[39]	EN 15625:2021 Railway applications - Braking - Automatic variable load sensing devices		
[39.1]	Variable load sensing devices	Appendix C, point 9, Table C.3	5, 6, 9
[40]	EN 286-3:1994 Simple unfired pressure vessels designed to contain air or nitrogen – Part 3: Steel pressure vessels designed for air braking equipment and auxiliary pneumatic equipment for railway rolling stock		
[40.1]	Air reservoirs - steel	Appendix C, point 9(f)	4, 5, 6, 7
[41]	EN 286-4:1994 Simple unfired pressure vessels designed to contain air or nitrogen – Part 4: Aluminium alloy pressure vessels designed for air braking equipment and auxiliary pneumatic equipment for railway rolling stock		
[41.1]	Air reservoirs - aluminium	Appendix C, point 9(f)	4, 5, 6, 7
[42]	EN 15807:2021 Railway applications - Pneumatic half couplings		
[42.1]	Interface of the brake pipe	Appendix C, point 9 (i)	5, 6, 9
[43]	EN 14601:2005+A1:2010+A2 :2021 Railway applications - Straight and angled end cocks for brake pipe and main reservoir pipe		
[43.1]	End cocks	Appendix C, point 9(i)	4, 5, 7, 9
[44]	UIC 541-1:2013 Brakes - Regulations concerning the design of brake components		
[44.1]	Brake mode switching device	Appendix C, point 9(i)	Appendix E

 OTIF	Uniform Technical Prescription (UTP)		UTP WAG
	ROLLING STOCK - FREIGHT WAGONS		Page 107 of 148
Status: DRAFT	Version 1	TECH-23020	Original: EN Date: 17.5.2023

<u>Index</u>	<u>Standard name</u>	<u>Standard reference</u>	<u>Standard version</u>
	Parameter	UTP Point	Standard Point
[45]	UIC 542:2015 Brake parts – Interchangeability		
[45.1]	Brake block holders	Appendix C, point 9 (k)	1 to 5
[46]	UIC 541-4:2020 Composite brake blocks - General conditions for certification and use		
[46.1]	Friction element for wheel tread brakes	Appendix C, point 9(l)	1, 2
[47]	EN 16452:2015+A1:2019 Railway applications - Braking - Brake blocks		
[47.1]	Friction element for wheel tread brakes	Appendix C, point 9(l)	4 to 11
[48]	EN 16241:2014+A1 :2016 Railway applications - Slack adjuster		
[48.1]	Slack adjusters Assessment of conformity	Appendix C, point 9(m)	4, 5, 6.2 6.3.2 to 6.3.5
[49]	EN 15595:2018+AC :2021 Railway applications - Braking - Wheel slide protection		
[49.1]	Wheel slide protection system	Appendix C, point 9 (n)	5 to 9, 11
[50]	EN 15085-1:2007+A1:2013 Railway applications -Welding of railway vehicles and components -Part 1: General		
[50.1]	Welding	Appendix C, point 12	4
[51]	EN 15085-2:2020 Railway applications - Welding of railway vehicles and components - Part 2: Requirements for welding manufacturer		
[51.1]	Welding	Appendix C, point 12	4, 5, 6, 7
[52]	EN 15085-3:2022 Railway applications - Welding of railway vehicles and components - Part 3: Design requirements		
[52.1]	Welding	Appendix C, point 12	4, 5, 6, 7
[53]	EN 15085-4:2007 Railway applications - Welding of railway vehicles and components - Part 4: Production requirements		
[53.1]	Welding	Appendix C, point 12	4, 5, 6
[54]	EN 15085-5:2007 Railway applications - Welding of railway vehicles and components - Part 5: Inspection, testing and documentation		

 OTIF	Uniform Technical Prescription (UTP)		UTP WAG
	ROLLING STOCK - FREIGHT WAGONS		Page 108 of 148
Status: DRAFT	Version 1	TECH-23020	Original: EN Date: 17.5.2023

<u>Index</u>	<u>Standard name</u>	<u>Standard reference</u>	<u>Standard version</u>
	Parameter	UTP Point	Standard Point
[54.1]	Welding	Appendix C, point 12	4 to 10
[55]	EN 13262:2020 Railway applications - Wheelsets and bogies - Wheels - Product requirements		
[55.1]	Specific product properties concerning the wheel	Appendix C, point 15	4, 5 and 6
[56]	UIC 535-2:2006 Standardisation and positioning on wagons of steps, end platforms, gangways, handrails, tow hooks, automatic coupler (AC), draw-only automatic coupler and brake valve controls on the UIC member RUs and OSJD member RUs		
[56.1]	Tow hooks Conditions for alternative solutions	Appendix C, point 16	1.4 1.4.2 to 1.4.9
[56.2]	Protective devices on protruding parts	Appendix C, point 17	1.3
[57]	IRS 50575:2020, Ed1 Railway applications -Wagons – Label-holders and hazard identification panels: interchangeability		
[57.1]	Label holders and attachment devices for rear end signal	Appendix C, point 18	2
[58]	EN 16834:2019 Railway applications - Braking – Brake performance		
[58.1]	Service brake	4.2.4.3.2.1	Annex D
[58.2]	Validation of brake performance calculated with Index [17]	4.2.4.3.2.1	6, 8, 9, 10, 12
[58.3]	Assessment of braking mode G	Appendix C, point 9, Table C.3	6, 8, 9, 12
[59]	EN 16839:2022 Railway applications - Rolling stock - Head stock layout		
[59.1]	Head stock layout	Appendix C, point 1	4 except 4.3, 5 except 5.5.2.3 and 5.5.2.4, 6, 7, 8

 OTIF	Uniform Technical Prescription (UTP)		UTP WAG
	ROLLING STOCK - FREIGHT WAGONS		Page 109 of 148
Status: DRAFT	Version 1	TECH-23020	Original: EN Date: 17.5.2023

D.2 Technical documents

<u>Index</u>	<u>Document name</u>	<u>reference</u>	<u>version</u>
	<u>Parameter</u>	<u>TSI Point</u>	<u>Standard Point</u>
[A]	<u>Interfaces between Control-Command and Signalling Trackside and other Subsystems Appendix A of CCS TSI, index [77] ERA/ERTMS/033281 V5.0</u>		
[A.1]	<u>train detection system based on track circuits</u>	<u>4.2.3.3(a)</u>	<u>axle distances (3.1.2.1, 3.1.2.3, 3.1.2.4, 3.1.2.5), vehicle axle load (3.1.7.1), impedance between wheels (3.1.9), use of composite brake blocks (3.1.6), if the rolling stock is equipped: use of shunt assisted devices (3.1.8), if the rolling stock has electrical or electronic equipment on board creating interference current in the rail: conducted interference (3.2.2).</u>
[A.2]	<u>train detection system based on axle counters</u>	<u>4.2.3.3(b)</u>	<u>axle distances (3.1.2.1, 3.1.2.2, 3.1.2.4, 3.1.2.5), wheel geometry (3.1.3.1-3.1.3.4), metal/inductive components-free space between wheels (3.1.3.5), wheel material (3.1.3.6), if the rolling stock has electrical or electronic equipment on board creating interference electromagnetic fields close to the wheel sensor: electromagnetic fields (3.2.1).</u>
[A.3]	<u>train detection system based on loop equipment</u>	<u>4.2.3.3(c)</u>	<u>vehicle metal construction (3.1.7.2).</u>
[A.4]	<u>Influencing unit</u>	<u>7.1.2 (d1)</u>	<u>Point 3.2</u>
[A.5]	<u>Vehicle impedance</u>	<u>7.1.2 (d1)</u>	<u>Point 3.2.2</u>
[A.6]	<u>Harmonised test method</u>	<u>7.1.2 (d1)</u>	<u>Point 3.2.1</u>
[A.7]	<u>Influencing unit</u>	<u>Appendix C, point 7</u>	<u>Point 3.2</u>
[A.8]	<u>Vehicle impedance</u>	<u>Appendix C, point 7</u>	<u>Point 3.2.2</u>
[A.9]	<u>Harmonised test method</u>	<u>Appendix C, point 7</u>	<u>Point 3.2.1</u>
[B]	<u>ERA Technical Document on codification of combined transport ERA/TD/CT version 1.1 (released on 2023-03-21)</u>		
[B.1]	<u>Codification of units intended to be used in combined transport</u>	<u>4.2.3.1 Appendix H</u>	<u>R2.2</u>

 OTIF	Uniform Technical Prescription (UTP)			UTP WAG
	ROLLING STOCK - FREIGHT WAGONS			Page 110 of 148
Status: DRAFT	Version 1	TECH-23020	Original: EN	Date: 17.5.2023

Standards and documents referred to in the additional optional conditions set out in Appendix C:

Additional optional conditions for units	App. C	Standard / UIC leaflet / document	
Manual coupling system	C.1	EN 15566:2009+A1:2010	All except 4.4
		EN 15551:2009+A1:2010	All
		EN 16116-2:2013	6.2.1, 6.3.2
		EN15877-1:2012	Figure 75
UIC footsteps and handrails	C.2	EN 16116-2:2013	4, 5, 6.2.2
Ability to be hump shunted	C.3	EN 12663-2:2010	5, 8
Tests concerning longitudinal compressive forces	C.8	EN 15839:2012+A1:2015	All
UIC brake	C.9	EN 15355:2008+A1:2010	All
		EN 15611:2008+A1:2010	All
		UIC 540:2014	All
		EN 14531-1:2015	4
		EN 15624:2008+A1:2010	All
		EN 15625:2008+A1:2010	All
		EN 286-3:1994	All
		EN 286-4:1994	All
		EN 15807:2011	All
		EN 14601:2005+A1:2010	All
		UIC 544-1:2014	All
		UIC 542:2015	All
		UIC 541-4:2010	All
		EN 16241:2014	4, 5, 6.3.2 to 6.3.5
EN 15595:2009+A1:2011	All		
Welding	C.12	EN 15085-1:2007+A1:2013	All
		EN 15085-2:2007	All
		EN 15085-3:2007	All
		EN 15085-4:2007	All
		EN 15085-5:2007	All
Specific product properties concerning the wheel	C.15	EN 13262: 2004 +A1:2008+A2:2011	All
		EN 13979-1:2003 +A1:2009+A2:2011	All
Tow hooks	C.16	UIC 535-2:2006	1.4
Protective devices on protruding parts	C.17	UIC 535-2:2006	1.3
Label holders and attachment devices for rear end signal	C.18	UIC 575:1995	1

 OTIF	Uniform Technical Prescription (UTP)			UTP WAG
	ROLLING STOCK - FREIGHT WAGONS			Page 111 of 148
Status: DRAFT	Version 1	TECH-23020	Original: EN	Date: 17.5.2023

Appendix E: Rear-end signal

1. Lamps

The colour of tail lamps shall be in accordance with ~~clause 5.5.3 of EN 15153-1:2013+A1:2016~~ [the specification referenced in Appendix D Index \[29\]](#).

The tail lamp shall be designed to display a lighting intensity in accordance with ~~table 8 of EN 15153-1:2013+A1:2016~~ [the specification referenced in Appendix D Index \[29\]](#).

The lamp shall be suitable to be attached to units complying with the attachment devices and the clearance set out in point 4.2.6.3. The lamp shall be equipped with:

- a switch (on/off)
- a warning light which indicates the battery status.

2. Reflective plates

The reflective plates shall be suitable to be attached to units complying with the attachment devices and the clearance set out in point 4.2.6.3. The reflective section of the plates shall be at least 150 by at least 200 mm as illustrated in figure E.1. The side triangles shall be white, the top and the bottom triangles shall be red. The plate shall be retro-reflective in accordance with ~~EN 12899-1:2007 Class Ref. 2~~ [the specification referenced in Appendix D Index \[30\]](#).

Fig. E.1 Reflective plate

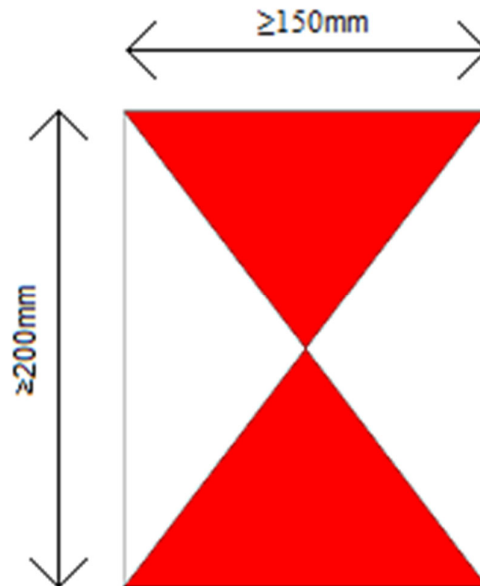

 OTIF	Uniform Technical Prescription (UTP)			UTP WAG
	ROLLING STOCK - FREIGHT WAGONS			Page 112 of 148
Status: DRAFT	Version 1	TECH-23020	Original: EN	Date: 17.5.2023

Appendix F: Assessment assigned to the production phases

Table F.1 Assessment assigned to the production phases

Characteristics to be assessed, as specified in section 4.2		Design and development phase		Production phase	Particular assessment procedure
		Design review	Type Test	Routine Test	
Element of the Rolling Stock sub-system	Point				Point
Structure and mechanical part	4.2.2				
End coupling	4.2.2.1.1	X	n.a.	n.a.	-
Inner coupling	4.2.2.1.2	X	n.a.	n.a.	-
Strength of unit	4.2.2.2	X	X	n.a.	6.2.2.1
Integrity of the unit	4.2.2.3	X	n.a.	n.a.	-
Vehicle track interaction and gauging	4.2.3				
Gauging	4.2.3.1	X	n.a.	n.a.	-
Compatibility with load carrying capacity of lines	4.2.3.2	X	X	n.a.	-
Compatibility with train detection systems	4.2.3.3	X	X	n.a.	-
Axle bearing condition monitoring	4.2.3.4	X	X	n.a.	-
Safety against derailment running on twisted track	4.2.3.5.1	X	X	n.a.	6.2.2.2
Running dynamic behaviour	4.2.3.5.2	X	X	n.a.	6.1.2.1 / 6.2.2.3
Derailment detection and prevention function	4.2.3.5.3	X	X	n.a.	-
Structural design of bogie frame	4.2.3.6.1	X	X.	n.a.	6.1.2.1
Characteristics of wheelsets	4.2.3.6.2	X	X	X	6.1.2.2
Characteristics of wheels	4.2.3.6.3	X	X	X	6.1.2.3
Characteristics of axles	4.2.3.6.4	X	X	X	6.1.2.4
Axle boxes / bearings	4.2.3.6.5	X	X	X	6.2.2.4
Automatic variable gauge system	4.2.3.6.6	X	X	X	6.1.2.6 / 6.2.2.4a

 OTIF	Uniform Technical Prescription (UTP)			UTP WAG
	ROLLING STOCK - FREIGHT WAGONS			Page 113 of 148
Status: DRAFT	Version 1	TECH-23020	Original: EN	Date: 17.5.2023

Characteristics to be assessed, as specified in section 4.2		Design and development phase		Production phase	Particular assessment procedure
		Design review	Type Test	Routine Test	
Running gear for manual change of wheelsets	4.2.3.6.7	X	X	n.a.	6.2.2.5
Brake	4.2.4				
Safety requirements	4.2.4.2	X	n.a	n.a	-
Functional and technical requirements	4.2.4.3	X	X	n.a	-
In-service brake	4.2.4.3.2.1	X	X	n.a.	-
Parking brake	4.2.4.3.2.2	X	n.a	n.a	-
Thermal capacity	4.2.4.3.3	X	X	n.a	6.2.2.6
Wheel slide protection (WSP)	4.2.4.3.4	X	X	n.a	-
Friction elements for wheel tread brakes	4.2.4.3.5	X	X	X	6:1:2:5
Environmental conditions	4.2.5				
Environmental conditions	4.2.5	X	n.a. / X ⁽¹⁾	n.a.	6.2.2.7
⁽¹⁾ Type test if and as defined by the applicant					
System protection	4.2.6				
Fire safety	4.2.6.1	X	X	n.a	6.2.2.8
Protection against electric hazard	4.2.6.2	X	X	n.a	-
Attachment devices for rear end signal	4.2.6.3	X	X	n.a	-

Appendix G: ~~List of fully approved composite brake blocks for international transport~~ exempted from a declaration of conformity as referred to in Article 8b

This Appendix is the “List of fully approved composite brake blocks for international transport”, reference: ERA/TD/2009-02/INT version 15.0 of 23 July 2015.

This Appendix, [referenced ERA/TD/2009-02/INT, Version 15.0](http://www.era.europa.eu) is published on the ERA website (<http://www.era.europa.eu>).

 OTIF	Uniform Technical Prescription (UTP)		UTP WAG	
	ROLLING STOCK - FREIGHT WAGONS		Page 114 of 148	
Status: DRAFT	Version 1	TECH-23020	Original: EN	Date: 17.5.2023

Appendix H: Interfaces with control command and signalling systems

This appendix is based on ERA document ERA/ERTMS/033281 rev. 4.0 as published on the ERA website and as referred to in the WAG TSI. The parameters in the Appendix define the interface between trains and train detection systems. The parameters and values are limited to those relevant for freight wagons within the technical scope of this UTP as defined in point 1.1. For corresponding EU texts see ERA document ERA/ERTMS/033281 rev. 4.0.

~~Axle distances (these values are used to define the distance between two consecutive axles in a train):~~

(66)

- ~~— For 1435 mm, 1600 mm and 1668 mm track gauges, the greatest distance between two consecutive axles shall not exceed 20,000 mm. For 1520 mm and 1524 mm track gauges the greatest distance between two consecutive axles shall not exceed 19,000 mm.~~
- ~~— The shortest distance between two consecutive axles [in mm] shall not be less than 7.2 times the maximum operational speed in km/h with a minimum of 720mm.~~
- ~~— The distance between the end axles of the wagon shall not be less than 3,000 mm.~~
- ~~— For 1435 mm, 1524 mm, 1600 mm and 1668 mm track gauges, the distance between the end of the vehicle (e.g. buffer) and the first axle of the unit shall not exceed 4,200 mm. For 1520 mm track gauge the distance shall not exceed 3,500 mm.~~

~~Impedance between wheels:~~

- ~~— The electrical resistance between the running surfaces of the opposite wheels of a wheelset shall not exceed 0.05 Ohm, measured at a voltage of between 1.8 VDC and 2.0 VDC (open circuit).~~

~~Wheel Geometry:~~

- ~~— Minimum wheel rim width shall be as specified in section 4.2.3.6.3 “Characteristics of wheels” of this UTP.~~
- ~~— The wheel diameter of hooped and massive wheels shall not be less than 330 mm for wagons with a maximum~~

⁶⁶ The corresponding EU requirements are set out in ERA document ERA/ERTMS/033281 version 4.0. Only the specifications relevant to freight wagons within the scope of this UTP are listed.

 OTIF	Uniform Technical Prescription (UTP)		UTP WAG	
	ROLLING STOCK - FREIGHT WAGONS		Page 115 of 148	
Status: DRAFT	Version 1	TECH-23020	Original: EN	Date: 17.5.2023

~~operational speed of 100 km/h or less. For wagons with a maximum operational speed of more than 100 km/h, the wheel diameter shall not be less than 150 mm ± 1.8 times the maximum operational speed in km/h. The wheel diameter of spoked wheels shall be at least 600 mm.~~

~~Minimum flange thickness shall be as specified in section 4.2.3.6.3 “Characteristics of wheels” of this UTP.~~

~~Flange height shall be as specified in section 4.2.3.6.3 “Characteristics of wheels” of this UTP.~~

~~The metal free space around wheels:~~

~~Only wheels and their parts (gearboxes, brake parts, etc.) or non ferromagnetic and non inductive components shall be mounted in the area defined in figure H.1.~~



Figure H.1

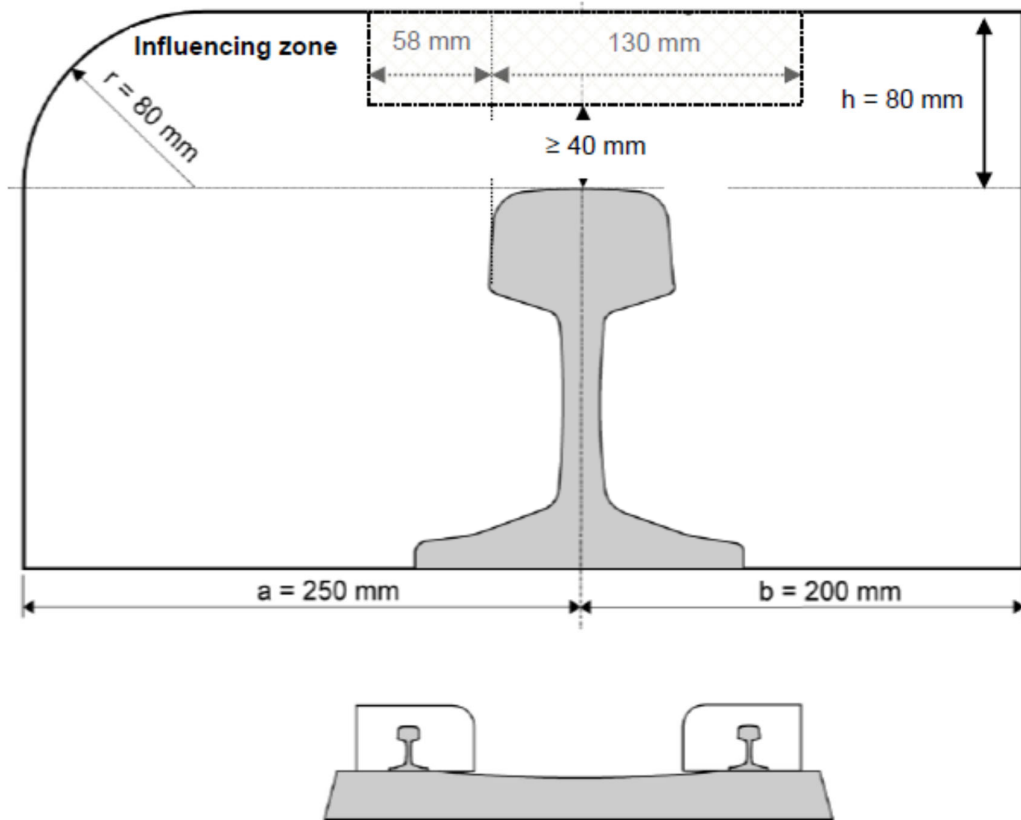

~~The characteristics of the wheel material regarding magnetic fields:~~

- ~~— The wheels shall have ferromagnetic characteristics and shall be electrically conductive.~~

~~Use of composite brake blocks~~

- ~~— If brake blocks are fitted these shall be assessed for the effects on the contact resistance between wheel and rail. Brake blocks listed in the list referred to in Appendix G of this UTP are deemed to be in conformity with this requirement.~~

~~Load and mass:~~

- ~~— For 1435 mm, 1524 mm, 1600 mm and 1668 mm track gauges, the minimum axle load in all load conditions shall be 3.5t for wagons with more than 4 axles and wheel~~



~~tread brakes; 4t for wagons with 4 axles and wheel tread brakes; 5t for other wagons. For 1520 mm track gauge the axle load shall be at least 11t for all types of wagons.~~

~~Use of shunt assisting devices~~

~~For 1520 mm track gauges the use of shunting assisting devices is required for axle loads less than 11t.~~

Figure H.2

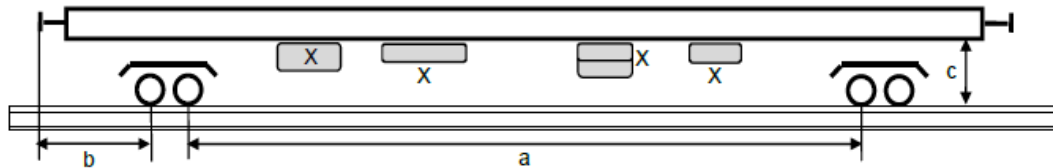

A: Defined distances and areas (the illustrated bogies with two axles are only an example; a bogie can consist of different numbers of axles)

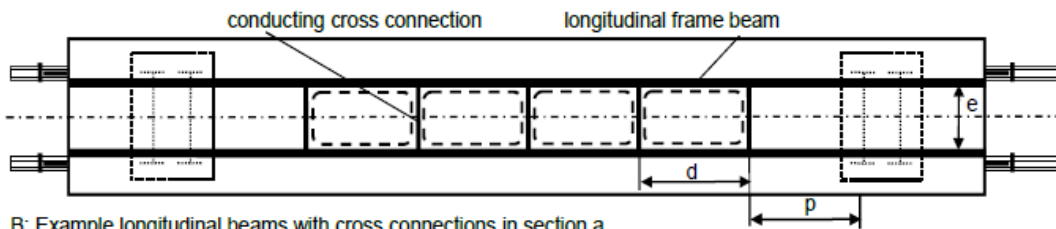

B: Example longitudinal beams with cross connections in section a

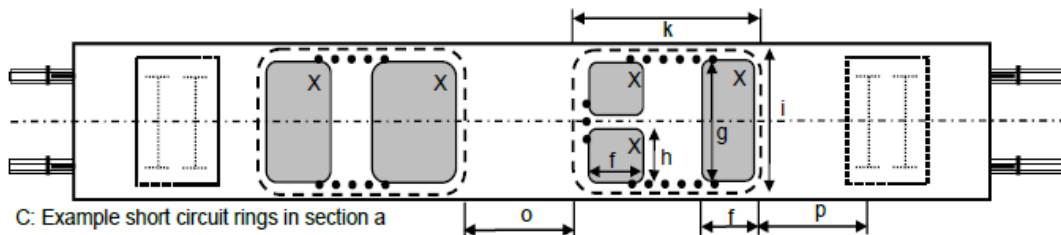

C: Example short circuit rings in section a

Resulting short circuit ring (electrically conducting loop)

Principle routing of the cables for the electrical connection of electrically conductive constituents

~~Harmonised parameter for 1435 mm track gauge:~~

~~In the following, “length” refers to the direction in parallel to the track and “width” refers to the direction orthogonal to the track.~~

 OTIF	Uniform Technical Prescription (UTP)			UTP WAG
	ROLLING STOCK - FREIGHT WAGONS			Page 118 of 148
Status: DRAFT	Version 1	TECH-23020	Original: EN	Date: 17.5.2023

~~The description of this parameter is done with reference to figure H.2:~~

- ~~— a: section (distance) between the inner axles of two adjacent bogies or wheel sets~~
- ~~— b: section (distance) between the first (respectively the last) axle and the nearest end of the vehicle (excluding the coupling systems)~~
- ~~— c: distance between top of rail and vehicle floor (bottom side)~~
- ~~— d: distance between adjacent conducting cross connections / length of short circuit rings (electrically conducting loops) formed by frame beams and conducting cross connections~~
- ~~— e: distance of adjacent longitudinal frame beams~~
- ~~— f, g, h: dimensions of electrically connected conducting constituents (X)~~
- ~~— i, k: dimensions of short circuit rings (electrically conducting loops) formed by electrically connected conducting constituents (X)~~
- ~~— o: distance between adjacent short circuit rings~~
- ~~— p: distance between short circuit rings and adjacent wheel sets~~
- ~~— X: conductive constituents mounted below vehicle floor~~

~~For the scope of this parameter, the vehicle is subdivided in different sections as shown in Figure H.2 [A]: a central section (a), two outer sections (b) and the sections of the bogies or single wheel sets. The parameter is respected when the design of the vehicle is such that at least one of the conditions 1, 2 or 3 is fulfilled in section (a) and section (b) and condition 4 (or alternatively at least one of the conditions 1, 2 or 3) is fulfilled in the sections of bogies or single wheel sets (in case of vehicles without bogies):~~

- ~~1. The distance (c) between rail level and vehicle floor (bottom side) is less than 1.06 m and the vehicle has a metal floor over its full length (excluding the coupling~~

 OTIF	Uniform Technical Prescription (UTP)		UTP WAG	
	ROLLING STOCK - FREIGHT WAGONS		Page 119 of 148	
Status: DRAFT	Version 1	TECH-23020	Original: EN	Date: 17.5.2023

~~systems) with a minimum width of 2 m and with a conductivity greater than 1 m/(Ω mm²).~~

- ~~2. The vehicle has constructive structures at least inside section (a) and (b) consisting of longitudinal frame beams symmetrically on both sides with a minimum distance (e) of 1.0 m. These are electrically connected with conducting cross connections in a distance (d) less than or equal to 3 m to form short circuit rings (electrically conducting loops) as illustrated in Figure H.2 [B], showing an example for section (a).~~

~~The electrical DC resistance of the resulting short circuit rings is lower than 1 Ω .~~

~~The distance (o) between adjacent short circuit rings does not exceed 3 m. The distance (p) between a short circuit ring and an adjacent wheel set of a bogie does not exceed 3 m, the distance to a single wheel set does not exceed 1.5 m.~~

~~The distance between rail level and short circuit rings on the bottom side of vehicle floor is less than 1.06 m.~~

- ~~3. The vehicle has electrically conducting constituents (X) mounted below the floor at least inside section (a) and (b). These are electrically connected to form short circuit rings (electrically conducting loops) as illustrated in Figure H.2 [C], showing an example for section (a). The dimensions of the constituents fulfil at least one of the following conditions:~~

~~a) minimum width (g) of 2 m and minimum longitudinal length (f) of 1 m;~~

~~b) minimum width (h) of 1 m and minimum longitudinal length (f) of 1 m on both long sides of the vehicle.~~

~~The electrical connection is done in a way that short circuit rings with a length (k) equal or more than 2.5 m but less or equal than 3 m and a minimum width (i) of 2 m~~

 OTIF	Uniform Technical Prescription (UTP)		UTP WAG	
	ROLLING STOCK - FREIGHT WAGONS		Page 120 of 148	
Status: DRAFT	Version 1	TECH-23020	Original: EN	Date: 17.5.2023

~~result. Figure H.2 [C] illustrates the principle routing of the cabling.~~

~~The conductivity of the conducting constituents is greater than $1 \text{ m}/(\Omega \cdot \text{mm}^2)$. The electrical DC resistance of the resulting short circuit rings is lower than 1Ω .~~

~~The distance (o) between adjacent short circuit rings does not exceed 3 m. The distance (p) between a short circuit ring and an adjacent wheel set of a bogie does not exceed 3 m, the distance to a single wheel set does not exceed 1.5 m.~~

~~The distance between rail level and short circuit rings on the bottom side of vehicle floor is less than 1.06 m.~~

- ~~4. Bogies consist of metal parts with a conductivity greater than $1 \text{ m}/(\Omega \cdot \text{mm}^2)$. Constructive supporting metal parts of a bogie frame are electrically connected with an electrical DC resistance lower than 1Ω . The distance between rail level and the bottom side of the bogie frame is less than 1.06 m.~~

~~Alternatively, if these requirements are not fulfilled at least condition 1, 2 or 3 shall be fulfilled in the section of the bogie.~~

~~This parameter ensures compatibility with loops.~~

~~Other equivalent solutions (e.g. field tests demonstrating that the passing vehicle creates sufficient change of inductivity of trackside loops) to demonstrate compatibility with such trackside loops are allowed.~~

~~There are no harmonised parameters for 1520 mm, 1524 mm, 1600 mm and 1668 mm track gauges.~~

 OTIF	Uniform Technical Prescription (UTP)			UTP WAG
	ROLLING STOCK - FREIGHT WAGONS			Page 121 of 148
Status: DRAFT	Version 1	TECH-23020	Original: EN	Date: 17.5.2023

Appendix H: Codification of units intended to be used in combined transport

The codification of units intended to be used in combined transport shall be in accordance with the specification referenced in Appendix D.2, Index [B].

The following requirements are applicable to units intended to be used in combined transport and requiring a Wagon Compatibility Code.

H.1 Wagon Compatibility Code

- (1) The Wagon Compatibility Code (WCC) specifies the type of Intermodal Loading Unit that can be loaded on the unit.
- (2) The WCC shall be determined for all units and assessed by a Notified Body.

H.2 Wagon Correction Digit

- (1) The Wagon Correction Digit (WCD) is the result of a comparison between the geometric characteristics of the unit under assessment and the characteristics of the reference wagons defined in point H.3.
- (2) This comparison shall be performed for all units and assessed by a Notified Body. The result of the assessment shall be included in the report of the Notified Body.
- (3) On the basis of the assessment:
 - For units having equivalent or more favourable geometric characteristics than the reference wagon, the WCD may be calculated if requested by the applicant.
 - For units having less favourable geometric characteristics than the reference wagon, the calculation of the WCD is not required by this TSI.

H.3 Characteristics of the reference wagons

The combined transport 'P' profiles are calculated on the basis of the characteristics of the reference recess wagon defined as:

- –Distance between bogie pivots (a) 11200mm
- –Bogie wheelbase (p) 1800mm
- –Height of semi-trailer (ST) loading plane 330mm
- –Maximum overhang (na) 2000mm
- –Load tolerance 10mm
- –Dissymmetry 1°
- –Height of ST + wagon roll centre (Hc) 1000mm

 OTIF	Uniform Technical Prescription (UTP)		UTP WAG	
	ROLLING STOCK - FREIGHT WAGONS		Page 122 of 148	
Status: DRAFT	Version 1	TECH-23020	Original: EN	Date: 17.5.2023

- -q+w play 11.5mm
- -Play in side bearers (J) 12mm
- -Half-distance between side bearers (bG) 850mm
- -ST + wagon flexibility (s) 0.3

The combined transport 'C' and ISO profiles are calculated on the basis of the characteristics of the reference wagon defined as:

- Distance between bogie pivots (a) 13500mm
- Bogie wheelbase (p) 1800mm
- Height of swap body loading plane 1175mm
- Maximum overhang (na) 2000mm
- Load tolerance 10mm
- Dissymmetry 1°
- Height of wagon roll centre (Hc) 500mm
- -q+w play 11.5mm
- -Play in side bearers (J) 12mm
- -Half-distance between side bearers (bG) 850mm
- -Wagon flexibility (s) 0.15".

 OTIF	Uniform Technical Prescription (UTP) ROLLING STOCK - FREIGHT WAGONS			UTP WAG Page 123 of 148
Status: DRAFT	Version 1	TECH-23020	Original: EN	Date: 17.5.2023

Appendix I

Not used.

Appendix J

Not used.

Appendix K

Not used.

Appendix L

Not used.

Appendix M

Not used.

Appendix N

Not used.

 OTIF	Uniform Technical Prescription (UTP)			UTP WAG
	ROLLING STOCK - FREIGHT WAGONS			Page 124 of 148
Status: DRAFT	Version 1	TECH-23020	Original: EN	Date: 17.5.2023

Appendix O: Conformity assessment of friction elements for wheel tread brakes

This appendix is a transcription of the ERA technical document ERA/TD/2013-02/INT version 3.0 of 27.11.2015 published on the ERA website and as referred to in the WAG TSI. It appears in full width in order to keep the drawings and tables readable.

1. INTRODUCTION

The present document provides the necessary specifications to perform the assessment of conformity of friction elements for wheel tread brakes. It is referred to in point 6.1.2.5 and Appendix D of the technical specification for interoperability relating to the subsystem ‘rolling stock – freight wagons’ following its amendment related to ‘friction elements for wheel tread brakes’ (ready for adoption in 2015).

The present document is based on EN 16452:2015 Railway applications - Braking - Brake blocks.

2. TERMS AND DEFINITIONS

For the purposes of this document the following terms and definitions apply:

Bg arrangement:	arrangement with one friction element per friction element holder
Bgu arrangement:	arrangement with two friction elements per friction element holder
1Bg:	unilateral configuration with one friction element per friction element holder
2Bg:	bilateral configuration with one friction element per friction element holder
1Bgu:	unilateral configuration with two friction elements per friction element holder
2Bgu:	bilateral configuration with two friction elements per friction element holder
friction element:	stator part of a tread brake adapted to generate a friction force when engaged with a wheel tread
friction element force:	force with which the friction element is made to come into contact with the wheel tread
friction element back plate:	element onto which the friction element is fixed, acting as the interface between the friction element and friction element holder
friction material:	consumable portion of the friction element that acts on the wheel tread in order to provide the specified brake performance
size of friction element:	product of height and width of the friction element without any correction for grooves
instantaneous friction coefficient:	value of friction coefficient at any one instant
mean friction coefficient:	value of instantaneous friction coefficient integrated over distance
dynamic friction coefficient:	coefficient of friction achieved by the friction material during relative movement between the friction material surface and wheel tread
static friction coefficient:	coefficient of friction achieved by the friction material at the point where relative movement between the friction material surface and wheel tread starts to take place
parking brake:	brake used to prevent a stationary train from moving under specified conditions, until intentionally released (also called ‘immobilization braking’)
wheel tread temperature:	average temperature out of three values measured by three rubbing thermocouples spaced equally across the wheel tread

 OTIF	Uniform Technical Prescription (UTP)			UTP WAG
	ROLLING STOCK - FREIGHT WAGONS			Page 125 of 148
Status: DRAFT	Version 1	TECH-23020	Original: EN	Date: 17.5.2023

3. ABBREVIATIONS

m [t]	Mass to be braked per wheel for design mass (including rotating mass) in conformity with EN 15663
m_1 [t]	Mass m in working order
m_2 [t]	Mass m under normal payload
m_{1W} [t]	Mass m in working order divided by the number of wheels
F_B [kN]	Nominal brake application force per wheel
F_{B1} [kN]	Total friction element application force per wheel for braked mass m_1
F_{B2} [kN]	Total friction element application force per wheel for braked mass m_2
F_b [kN]	Instantaneous application force per wheel
F_{PB} [kN]	Parking brake application force
v [km/h]	Theoretical initial speed at the brake application initiation
v_m [km/h]	Maximum service speed
μ_a [-]	Instantaneous friction coefficient determined at every instance of the braking by the ratio between the total brake force F_{IR} and the total application force F_b
μ_m [-]	Mean friction coefficient determined from reaching 95 % of the nominal application force F_B of the instantaneous friction coefficient μ_a for the stopping distance s_2
μ_{dyn} [-]	Dynamic friction coefficient
μ_{stat} [-]	Static friction coefficient
θ_0 [°C]	Mean initial temperature of the wheel tread at the beginning of the brake application
s_1 [m]	Stopping distance from beginning of the brake application to rest
s_2 [m]	Stopping distance from the moment on when $F_b = 0.95 F_B$ to rest
D [mm]	Diameter of wheel
P [-]	Brake type – P = passenger

4. DYNAMIC FRICTION COEFFICIENT

4.1. Test programme

The dynamometer test program for friction elements for wheel tread brakes to determine the dynamic friction coefficient μ_{dyn} is set out in table 1. The corresponding terms, definitions and abbreviations are explained in sections 2 and 3.



 OTIF	Uniform Technical Prescription (UTP)			UTP WAG
	ROLLING STOCK - FREIGHT WAGONS			Page 126 of 148
Status: DRAFT	Version 1	TECH-23020	Original: EN	Date: 17.5.2023

Table 1: Dynamometer test program to determine the dynamic friction coefficient

Friction element arrangement			To be defined by the applicant					
Wheel type			In conformity with EN 13979-1					
Wheel diameter			$\varnothing X \pm 5$ mm last machining size before wheel is fully worn in accordance with EN 13979-1					
Water flow rate			X l/h (without specific requirements 14 l/h should be used)					
No. of brake application			Initial speed	Total F_B per wheel	Initial temp.	Mass to brake per wheel	Weighting after	Remarks
			v	F_B	θ_0	m		
			[km/h]	[kN]	[°C]	[t]	No.	
1.1 - 1.X			$3/4 v_m$	$2/3 F_{B2}$	20-100	m_2	1.X	Brake applications to rest under dry conditions to allow bedding of the friction elements up to at least 85 % of the friction element surface
1	3	5	$3/4 v_m$	F_{B2}	50-60	m_2		Brake applications to rest under dry conditions, after a period of cooling
2	4	6	v_m					
7 to 26			$3/4 v_m$	$2/3 F_{B1}$	20-100	m_1		Conditioning stops
27	39		$3/4 v_m$	$2/3 F_{B1}$	50-60	m_1		Brake applications to rest under dry conditions, after a period of cooling
28	40		$1/4 v_m$					
29	41		v_m					
30	42		$1/2 v_m$					
31	43		$3/4 v_m$	$1/3 F_{B1}$	50-60	m_1		Brake applications to rest under dry conditions, after a period of cooling
32	44		$1/4 v_m$					
33	45		v_m					
34	46		$1/2 v_m$					
35	47		$3/4 v_m$	F_{B1}	50-60	m_1		Brake applications to rest under dry conditions, after a period of cooling
36	48		$1/4 v_m$					
37	49		v_m					
38	50		$1/2 v_m$					
51			$3/4 v_m$	-	-	-		10 kW drag brake application for a period of 15 min in dry condition done immediately after brake n° 50 without interruption. This is to evenly distribute the residual stress within the wheel

 OTIF	Uniform Technical Prescription (UTP)			UTP WAG
	ROLLING STOCK - FREIGHT WAGONS			Page 127 of 148
Status: DRAFT	Version 1	TECH-23020	Original: EN	Date: 17.5.2023

No. of brake application			Initial speed	Total F_B per wheel	Initial temp.	Mass to brake per wheel	Weighing after	Remarks
			v	F_B	θ_0	m		
			[km/h]	[kN]	[°C]	[t]	No.	
52	64	76	$3/4 v_m$	$2/3 F_{B1}$	20-30	m_1		Brake applications to rest under wet conditions, after a period of cooling
53	65	77	$1/4 v_m$					
54	66	78	v_m					
55	67	79	$1/2 v_m$					
56	68	80	$3/4 v_m$	$1/3 F_{B1}$	20-30	m_1		Brake applications to rest under wet conditions, after a period of cooling
57	69	81	$1/4 v_m$					
58	70	82	v_m					
59	71	83	$1/2 v_m$					
60	72	84	$3/4 v_m$	F_{B1}	20-30	m_1		Brake applications to rest under wet conditions, after a period of cooling
61	73	85	$1/4 v_m$					
62	74	86	v_m					
63	75	87	$1/2 v_m$					
88		92	$3/4 v_m$	F_{B2}	20-30	m_2		Brake applications to rest under wet conditions, after a period of cooling
89		93	$1/4 v_m$					
90		94	v_m					
91		95	$1/2 v_m$					
96			$3/4 v_m$	-	-	-	96	10 kW drag brake application for a period of 15 min in dry condition done immediately after brake n° 95 without interruption to dry the friction element
97		109	$3/4 v_m$	$2/3 F_{B2}$	50-60	m_2		Brake applications to rest under dry conditions, after a period of cooling
98		110	$1/4 v_m$					
99		111	v_m					
100		112	$1/2 v_m$					
101		113	$3/4 v_m$	$1/3 F_{B2}$	50-60	m_2		Brake applications to rest under dry conditions, after a period of cooling
102		114	$1/4 v_m$					
103		115	v_m					
104		116	$1/2 v_m$					
105		117	$3/4 v_m$	FB2	50-60	m_2		Brake applications to rest under dry conditions, after a period of cooling
106		118	$1/4 v_m$					
107		119	v_m					
108		120	$1/2 v_m$					
121			$3/4 v_m$	F_{B2}	110-120 ^a	m_2		Brake applications to rest under dry conditions with high initial temperature, after a period of cooling
122			$1/4 v_m$					
123			v_m					
124			$1/2 v_m$					

 OTIF	Uniform Technical Prescription (UTP)			UTP WAG
	ROLLING STOCK - FREIGHT WAGONS			Page 128 of 148
Status: DRAFT	Version 1	TECH-23020	Original: EN	Date: 17.5.2023

No. of brake application	Initial speed	Total F _B per wheel	Initial temp.	Mass to brake per wheel	Weighing after	Remarks
	v	F_B	θ_0	m		
	[km/h]	[kN]	[°C]	[t]	No.	
125 126 127 128	$3/4 v_m$ $1/4 v_m$ v_m $1/2 v_m$	$2/3 F_{B2}$	50-60	m_2	128	Brake applications to rest under dry conditions, after a period of cooling
129	$3/4 v_m$	-	20-60	-		Simulation of a downhill brake application with a power of 45 kW for a period of 34 min
130	$3/4 v_m$	F_{B2}	-	m_2		Brake application to rest under dry conditions immediately after the simulation of a downhill brake application, without any cooling break
131 to 140	v_m	$2/3 F_{B2}$	50-60	m_2		Conditioning stops
141 142 143 144	145 146 147 148	F_{B2}	50-60	m_2	148	Brake applications to rest under dry conditions, after a period of cooling
149	$3/4 v_m$	-	-	-		10 kW drag brake application for a period of 10 min in dry condition done immediately after brake n° 148 without interruption. This is to evenly distribute the residual stress within the wheel
^a If the temperature obtained during stop numbers 120 and 122 is below 110 °C, stop numbers 121 and 123 shall be performed with the temperature achieved at the time.						

During the tests described in table 1 the following conditions shall be respected:

- The speed and ventilation conditions shall be as set out in table 2.

 OTIF	Uniform Technical Prescription (UTP)			UTP WAG
	ROLLING STOCK - FREIGHT WAGONS			Page 129 of 148
Status: DRAFT	Version 1	TECH-23020	Original: EN	Date: 17.5.2023

Table 2: Speed and ventilation conditions

	Speed simulated on the test bench [km/h]		Speed of the cooling air [km/h]	
	Under dry conditions	Under wet conditions	Under dry conditions	Under wet conditions
During braking at				
$v \leq 80\text{km/h}$	v	v	$v/2$	10
$v > 80\text{km/h}$	v	v	40	10
Between the brake applications	100	50	40	10

- The time to reach 95 % of the demanded FB shall be $4\text{ s} \pm 0,2\text{ s}$.
- During bedding-in the following minimum numbers of brake stops shall be carried out: 40 for organic friction elements and 80 for sintered friction elements.
- If interruptions of the test program occur, before recommencing the program the previous 5 stops shall be repeated. In this case the initial temperature for the first stop shall be in the range from 20 °C to 60 °C.
- In the case of an interruption prior to the first wet stop, one brake application identical to the last brake application under dry conditions shall be carried out outside of the program.
- Concerning the brake applications under wet conditions, the wheel wetting shall not be interrupted during each entire set of stops under wet conditions (including cooling period). For any first stop under wet conditions after a stop under dry conditions, the start of the wheel tread wetting shall take place only when the temperature of the wheel tread is below 80 °C.
- During the test under wet conditions the water shall be equally distributed over the wheel tread.
- During the simulation of a downhill the chosen power and speed shall be kept constant.

4.2. Values to be determined in order to define the area of use

The values for the following parameters shall be determined and recorded within the area of use:

- a) Tested configuration consisting of
 - friction element arrangement
 - wheel type
 - nominal and tested wheel diameter
- b) Mean dynamic friction coefficient of non-bedded and bedded state. The mean dynamic friction coefficient of the non-bedded and bedded state are defined as the average of the first 5 and the last 5 measured values of brake application n° 1.1 to 1.X.
- c) Mean dynamic friction coefficient under dry conditions versus the initial operating speed v for the different brake forces F_B applied and the mass to brake per wheel m using the template diagrams set out in table 3.



 OTIF	Uniform Technical Prescription (UTP)			UTP WAG
	ROLLING STOCK - FREIGHT WAGONS			Page 130 of 148
Status: DRAFT	Version 1	TECH-23020	Original: EN	Date: 17.5.2023

Table 3: Template diagrams and allocated brake application n°

		
Brake application n° 31 to 34 and 43 to 46	Brake application n° 27 to 30 and 39 to 42	Brake application n° 35 to 38 and 47 to 50
		
Brake application n° 101 to 104 and 113 to 116	Brake application n° 97 to 100 and 109 to 112	Brake application n° 105 to 108 and 117 to 120

- d) Mean dynamic friction coefficient variation under wet conditions. The variation shall be expressed as the averages of the measured mean dynamic friction coefficients under wet conditions (brake application n° 52 to 95) in proportion to the corresponding averages of mean dynamic friction coefficients under dry conditions (brake application n° 27 to 50, 105 to 108 and 117 to 120). Example: the average value of brake applications n° 57, 69 and 81 divided by the average value of brake applications n° 32 and 44.
- e) Mean dynamic friction coefficient variation at high initial temperature. The variation shall be expressed as the mean dynamic friction coefficients at a wheel tread temperature above 110 °C (brake application n° 121 to 124) in proportion to the corresponding mean dynamic friction coefficients at a wheel tread temperature below 60 °C (brake application n° 125 to 128). Example: The value of brake application n° 122 divided by the value of brake applications n° 126.
- f) Chart of the instantaneous dynamic friction coefficient and wheel tread temperature versus time of brake application n° 129.
- g) Mean dynamic friction coefficient variation after simulation of a downhill brake application. The variation shall be expressed as the averages of the measured mean dynamic friction coefficients after downhill braking (brake application n° 141 to 148) in proportion to the corresponding averages of mean dynamic friction coefficients before downhill braking (brake application n° 105 to 108 and 117 to 120). Example: the average value of brake applications n° 142 and 146 divided by the average value of brake applications n° 106 and 118.

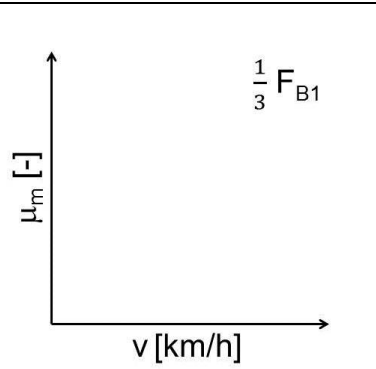
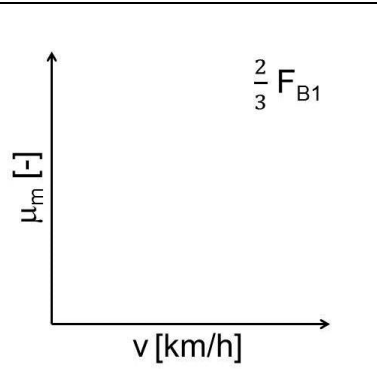
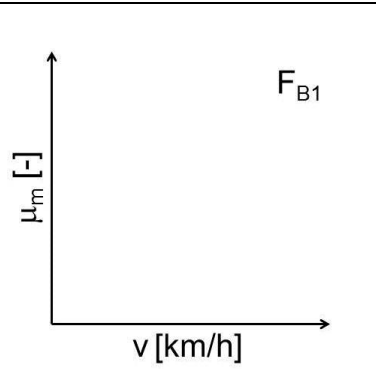
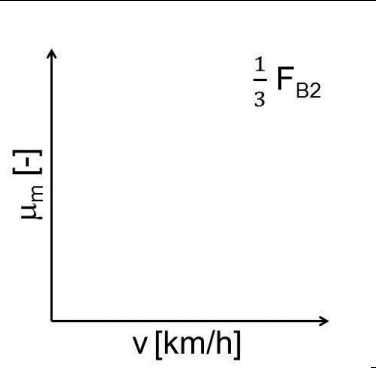
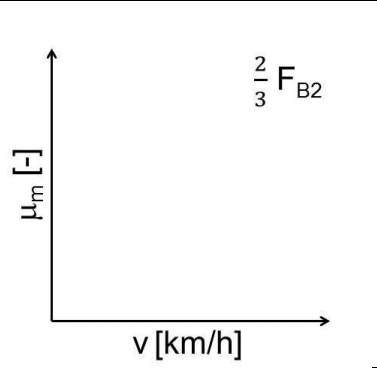
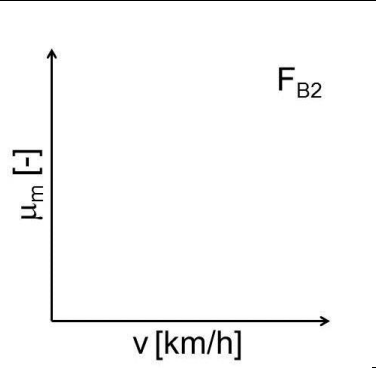
 OTIF	Uniform Technical Prescription (UTP)			UTP WAG
	ROLLING STOCK - FREIGHT WAGONS			Page 131 of 148
Status: DRAFT	Version 1	TECH-23020	Original: EN	Date: 17.5.2023

In relation to the characteristics described in this chapter, in case the manufacturer chooses to apply some of the harmonised acceptance criteria for dynamic friction performance as specified in EN 16452:2015, the compliance to these harmonised acceptance criteria have to be stated in the technical documentation as part of the area of use of the friction element for wheel tread brakes.

5. STATIC FRICTION COEFFICIENT

5.1. Test program

The dynamometer test program to determine the static friction coefficient μ_{stat} of friction elements for wheel tread brakes is set out in table 4. The corresponding terms, definitions and abbreviations are explained in sections 2 and 3.

Table 4: Dynamometer test program to determine the static friction coefficient

Friction element configuration	To be defined by the applicant				
Wheel type	In conformity with EN 13979-1				
Wheel diameter	$\varnothing X \pm 5$ mm last machining size before wheel is fully worn in accordance with EN 13979-1				
No. of brake application	Initial speed	Parking brake application force	Initial temp.	Mass to brake per wheel	Remarks
	v	F_{PB}	θ_0	m	
	[km/h]	[kN]	[°C]	[t]	
R.1 - R.X	v_m	$2/3 F_{PBmax}$	20-100	m_2	Brake applications to rest under dry conditions to allow bedding of the friction elements up to a contact pattern of 100 % is reached
1 to 5 6 to 10 11 to 15 16 to 20	-	$1/4 F_{PBmax}$ $1/2 F_{PBmax}$ $3/4 F_{PBmax}$ F_{PBmax}	< 30	-	-

During the test described in table 4 the following conditions shall be respected:

- The wheel tread hollow wear at the start of the test shall not exceed 1 mm. The state of the surface of the wheel tread shall be documented in the test report.
- The torque shall be continuously increased. The start of the rotation shall occur between 0,3 s and 2,0 s after the beginning of the build-up of the rotating torque.
- The relative movement between wheel and friction element shall be measured with an accuracy of at least 30 milliradian. It shall be ensured that displacements due to clearances are excluded.

For each brake application (n°1 to 20) the static friction coefficient shall be determined which is the value of the instantaneous friction coefficient at the time corresponding to the commencement of sliding (mean value calculated from the measurement records for the intersection between the linearised characteristic line of the rotation angle and the time axis) as described in figure 1.

 OTIF	Uniform Technical Prescription (UTP)			UTP WAG
	ROLLING STOCK - FREIGHT WAGONS			Page 132 of 148
Status: DRAFT	Version 1	TECH-23020	Original: EN	Date: 17.5.2023

Figure 1: Principles for the determination of the static friction coefficient



Key

- A friction coefficient (μ) / rotation angle of wheel
- B time axis
- C example of friction coefficient curve
- D rotation angle of wheel
- E straight regression line
- F intersection between straight regression line and time axis
- G value of static coefficient

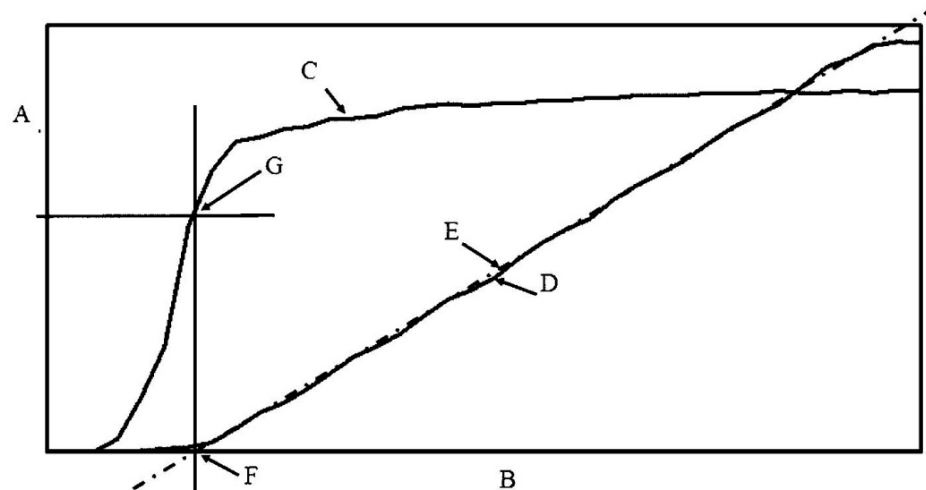
5.2. Values to be determined in order to define the area of use

For each force the average value of the 5 measurements shall be determined. The lowest average value is the characterising static friction coefficient.

6. MECHANICAL CHARACTERISTICS

The mechanical characteristics of the assembly between back plate and friction element for wheel tread brakes shall be tested in accordance with the test procedures set out in sections 6.1 and 6.2.

6.1. Shear strength

The test shall be performed with the mounting as set out in figure 2. In the case of a friction element consisting of two parts or a mono-bloc friction element with a central groove, a wedge (g) shall be placed in the central groove as shown.

 OTIF	Uniform Technical Prescription (UTP)		UTP WAG
	Rolling stock - FREIGHT WAGONS		Page 133 of 148
Status: ADOPTED		TECH-20042 Annex	Original: EN
			Date: 22.6.2021

Figure 2: Shear strength test mounting arrangement



Key

- a brake shoe insert back plate
- b brake shoe insert fixing key
- c friction element
- d side panel
- e force application fixing
- f test force F_{test}
- g brake shoe insert groove filling device

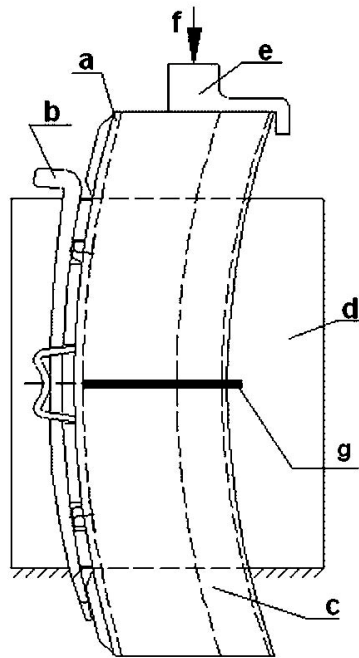
The test force F_{test} shall be applied in a continuous and progressive way up to 1.5 times the maximum permissible braking force applied at one friction element within 4 s and shall be kept for a period of at least 2 min.

At the end of the test there shall not be any indication of detachment of the back plate from the friction element or any other visible mechanical damage.

6.2. Flexural strength

Two tests shall be performed, one with the mounting 1 and one with the mounting 2 as set out in figure 3. The end of the supports shall have a radius of 5 mm. For both tests new friction elements shall be used and the test force F_{test} shall be applied five times. F_{test} is the maximum permissible application force applied at one friction element.

The following distances shall be respected:

- $L_s 1$ = friction element length - 50 mm.
- $L_s 2$ = half friction element length - 50 mm.

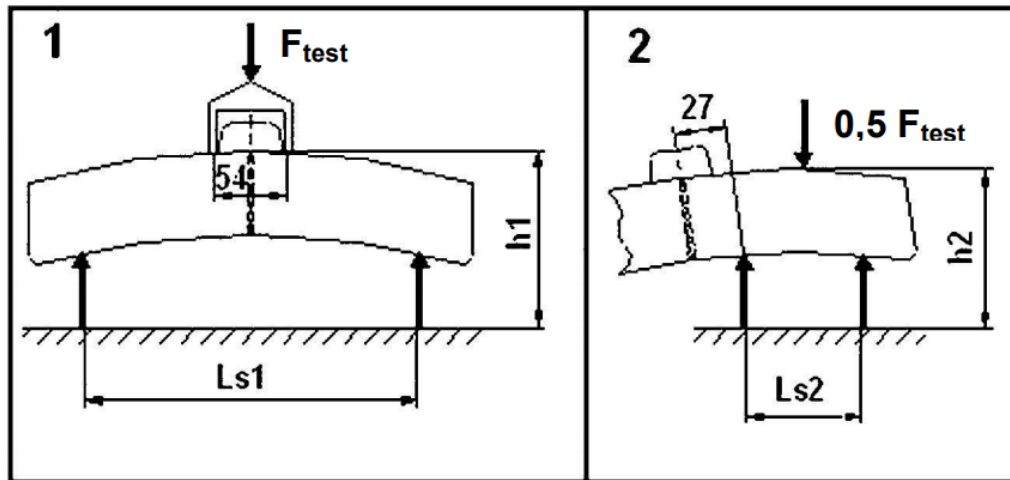

Figure 3: Flexural strength test mounting arrangement

**Key**

- 1 mounting for performing test n°1
- 2 mounting for performing test n°2

Within 4 s the test force shall be applied progressively until either the maximum test force F_{test} is achieved or the maximum displacement $\Delta h1$ respectively $\Delta h2$ for the intended application occurs taking into account the nominal geometry of a new friction element and a new wheel.

The force respectively the displacement shall be kept for a period of at least 2 minutes.

At the end of the test, the friction element shall not show any crack initiation or fracture of the back plate. In the case of a friction element that has a groove or slot as shown in figure 3 cracking is permitted in the area where the friction element is at its thinnest where the groove meets the back plate.

7. SUITABILITY FOR TRAIN DETECTION BY SYSTEMS BASED ON TRACK CIRCUITS

The following rig test to demonstrate the suitability for train detection by systems based on track circuits is only applicable if the friction element is intended to be used in subsystems which fall under the following scope:

- Nominal wheel diameters of 680 mm to 920 mm
- Friction element configurations 1Bg, 1Bgu, 2Bg and 2Bgu
- Mass per wheel ≥ 1.8 t

Cast iron brake blocks are deemed to be suitable for train detection by systems based on track circuits.

7.1. Test program

A number of 10 friction element samples of a given size as set out in clause 7.1.3 shall be subject to the test program provided in figure 4 and further described in clauses 7.1.1 to 7.1.6.



Figure 4: Flow chart of the test program

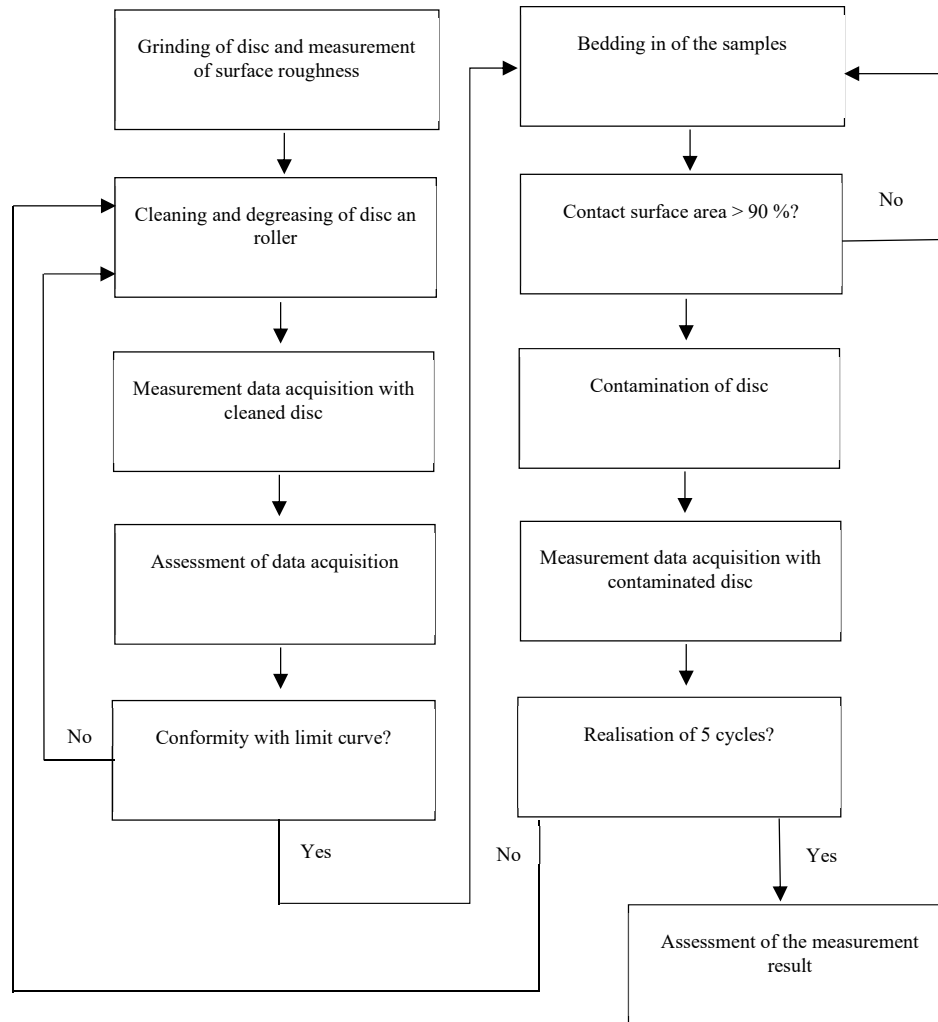

7.1.1. Grinding of disc and measurement of surface roughness

Before the first test of each pair of friction element samples the disc shall be grinded and the surface roughness R_z (maximum height of profile) shall be lower than or equal to 12 µm.

7.1.2. Cleaning and degreasing of disc and roller

The disc shall be cleaned and degreased with emery paper of grade 180, cloths in micro-fibres and of water/spray acetone in order to remove the residual material and satins from previous tests.

The roller and the surface of the carbon brush shall be cleaned and degreased in order to remove dust particles adhering to the surface.

7.1.3. Cutting of the samples

The cutting of samples shall be carried out without lubrication. The samples shall be cut along the friction surface of the friction element. The friction surface of the samples shall be the one which was originally the closest to the

 OTIF	Uniform Technical Prescription (UTP)		UTP WAG
	Rolling stock - FREIGHT WAGONS		Page 136 of 148
Status: ADOPTED		TECH-20042 Annex	Original: EN
			Date: 22.6.2021

friction surface of the friction element in order to maintain the original application orientation of the material. The sample dimensions are provided in figure 5.

Figure 5: Sample

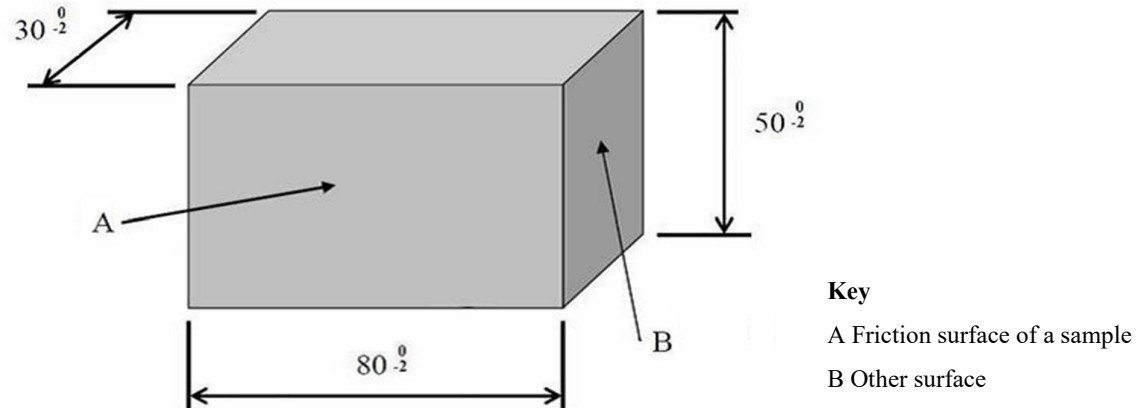

7.1.4. Bedding in of samples

For each cycle two new samples shall be bedded in. The bedding in shall be performed by stop brakings on the cleaned and degreased disc under the following conditions:

- Speed of 100 km/h in the centre of the samples' friction surface
- Braked mass of 0,41 t
- Surface pressure of 40 N/cm²

The bedding in shall achieve a contact surface area of more than 90 %.

7.1.5. Contamination of disc

The disc shall be contaminated by continuous braking under the following conditions:

- Speed of 70 km/h in the centre of the samples' friction surface
- Brake torque of 51 Nm
- The contamination phase ends as soon as the disc temperature has reached 400 °C or after 2 400 s of continuous braking

Before carrying out the measurement as described in clause 7.1.6 the disc shall be cooled down below 40 °C.

7.1.6. Measurements

The measurement of the impedance shall be carried out with a measurement set up as schematically described in figure 6.

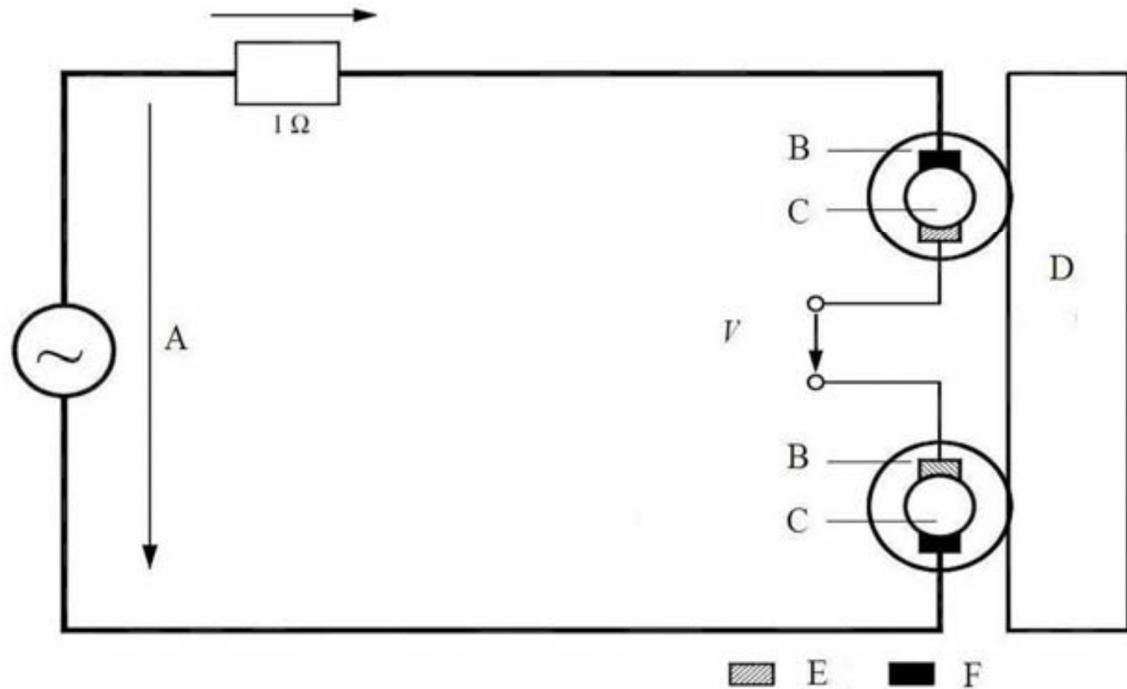

Figure 6: Schematic diagram of the measurement set up

**Key**

A	Applied voltage (electrical cycle)	B	Roller made of rail steel
C	Shaft made of copper	D	Disc made of wheel steel (clean/contaminated)
E	Carbon brush – measured voltage	F	Carbon brush – applied voltage
V	Measured voltage		

The electrical contact to the disc is achieved by means of two rollers with a contact force of 14 N each (view of rollers, shaft and brushes in figure 6 are rotated by 90°).

The impedance measurement:

- of the cleaned disc and
- of the contaminated disc

relates to four different measuring traces equally distributed over the radius in the contaminated area. In accordance with figure 4 five measurement cycles shall be conducted, so that the impedance of 20 traces is measured at a total.

The impedance on each trace is measured both statically and dynamically by applying the electrical cycle as defined in figure 7. During the dynamical measurement the disc shall rotate at a speed of 60 rpm.



Figure 7: Electrical cycle

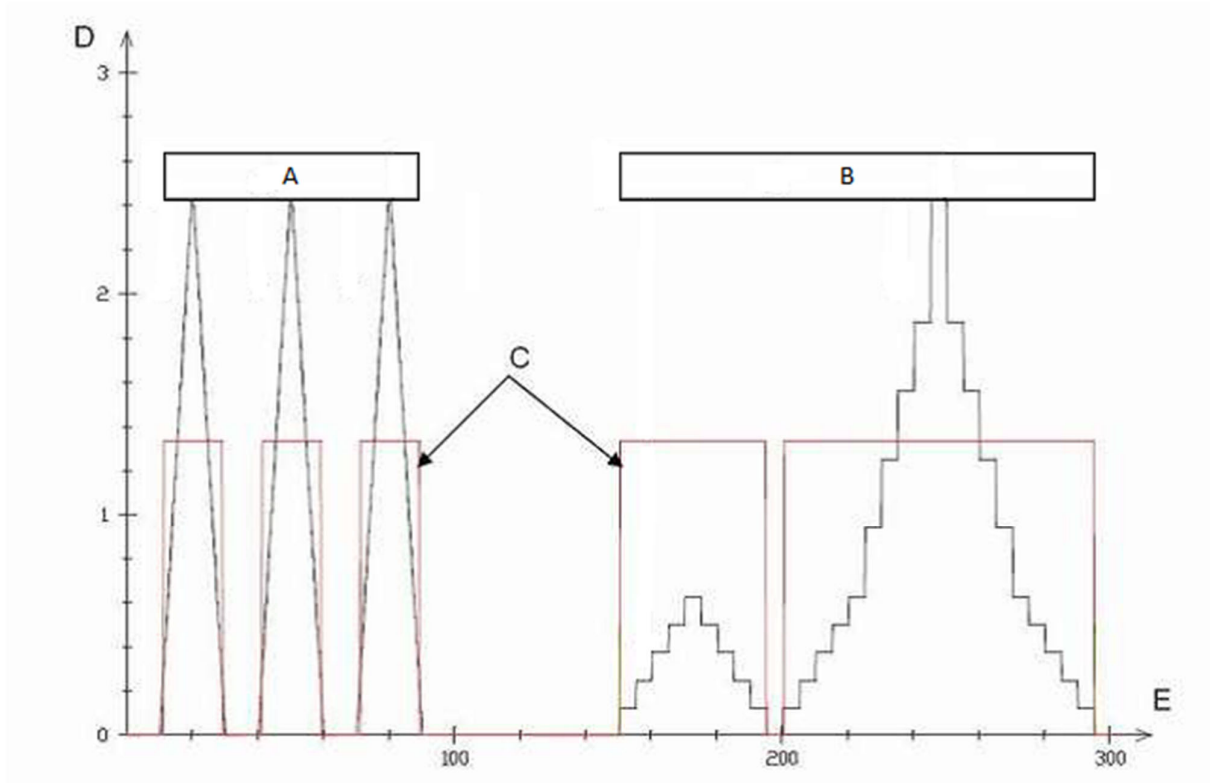

Key

- A Static tests
- B Dynamic tests
- C Area for measurements
- D Applied voltage [V]
- E Time [s]

The resulting current and voltage are measured by a four-wire impedance measurement method and digitalized. The frequency of applied voltage and current is set to 42 Hz. A summation and a verified sliding mean value averaging provide a new impedance value every 10 ms.

7.2. Assessment of the measurement results

An automatic evaluation of the results shall be carried out.

The (several hundred thousand) impedance values obtained during the course of the measurements shall be allocated to the impedance classes indicated as 'B' in figures 8 and 9. The total number of impedance values of each impedance class shall be compared with the limit values indicated as 'C' in figures 8 and 9.

The number of impedance values measured with the cleaned disc shall be lower in each impedance class than the corresponding limit values as set out in figure 8. If the limit values are not respected, the cleaning of the disc shall be carried out once again as described in figure 4.



Figure 8: Limit values per impedance class for cleaned disc

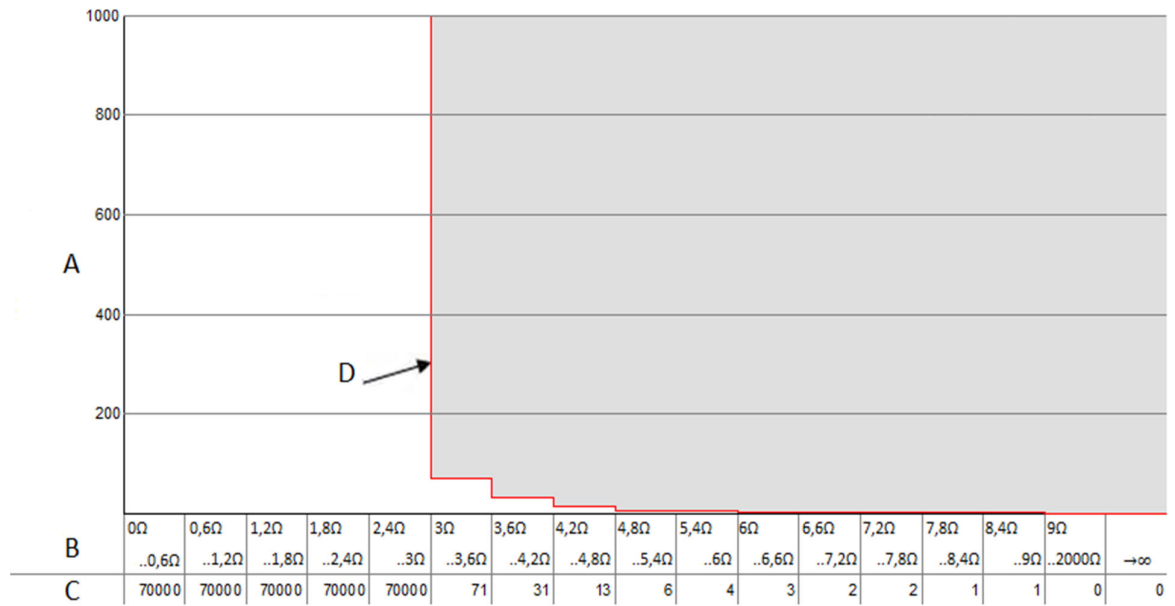

Key

- A Frequency distribution of impedance per class
- B Impedance classes
- C Limit values of frequency distribution of impedance per class
- D Limit curve

The number of impedance values measured with the contaminated disc shall be lower in each impedance class than the corresponding limit values as set out in figure 9.

 OTIF	Uniform Technical Prescription (UTP)		UTP WAG
	Rolling stock - FREIGHT WAGONS		Page 140 of 148
Status: ADOPTED		TECH-20042 Annex	Original: EN Date: 22.6.2021

Figure 9: Limit values per impedance class for contaminated disc



Key

- A Frequency distribution of impedance per class
- B Impedance classes
- C Limit values of frequency distribution of impedance per class
- D Limit curve

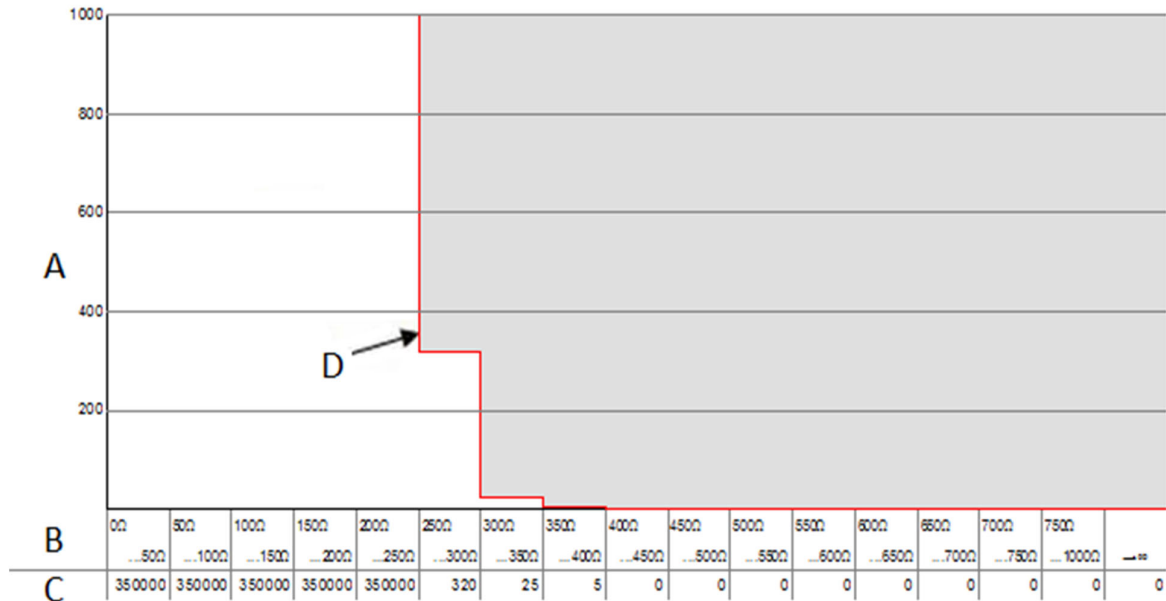
8. SUITABILITY FOR SEVERE ENVIRONMENTAL CONDITIONS

The suitability of the friction element acting on wheel tread brakes for severe environmental conditions shall be tested in accordance with the test procedures set out in sections 8.1 or 8.2. The corresponding terms, definitions and abbreviations are explained in sections 2 and 3.

Cast iron brake blocks are deemed to be suitable for severe environmental conditions.

8.1. Test run

8.1.1. Test program to demonstrate the braking properties under severe environmental conditions

The goal of this test run is to compare the results of tests without snow fly-off ('reference tests') with those with snow fly-off ('winter tests') and to determine the braking properties of friction elements acting on wheel tread brakes for severe environmental conditions under real conditions of use.

'Reference tests' and 'winter tests' shall be performed consecutively within one single period of up to 4 weeks. A running period of at least 10 min is to be observed between brake applications, with a maximum of 4 brake applications performed per hour.

The brake initiation speeds shall be:

- 60 km/h (for information purposes, to monitor the plausibility and comparability of the efficiency between 'reference tests' and 'winter tests'),
- if the maximum speed is 100 km/h or more: 85 % of the intended maximum speed but not more than 100 km/h, and



- 100 % of the intended maximum speed
respectively.

The tests shall be performed...

- ...with a train consisting of one locomotive and 5 wagons fulfilling the following:
 - The locomotive shall have disconnected dynamic and indirect braking.
 - The maximum dynamic mass of the locomotive shall be lower than 100 t.
 - The test wagons shall be of the same design with the same equipment and have an 'open' bogie design e.g. Y25.
 - The wheelset load when empty (without payload) shall be max. 7 t.
 - The arrangement of the friction elements shall be the one with the lowest intended specific pressure at emergency brake.
 - The emergency brake shall be applied.
 - The bedding in shall achieve a contact surface area of more than 85 %.
- ...on lines with mean gradient over the stopping distance lower than 3 ‰; maximum gradient lower than or equal to 5 ‰ and curve radii higher than or equal to 1000 m
- ...under the following environmental conditions:
 - 'Reference test': No snow fly-off (snow level 0, see figure 10) at external temperatures of up to +5°C.
 - 'Winter tests': During the winter semester with snow on the lines and with snow fly-off (snow level 3 to 5, see figures 11 and 12) at external temperatures between zero and -10 °C.

Figure 10: Reference test (snow level 0)





OTIF

Uniform Technical Prescription (UTP)

Rolling stock - FREIGHT WAGONS

UTP WAG

Page 142 of 148

Status: **ADOPTED**

TECH-20042 Annex

Original: EN

Date: 22.6.2021

Figure 11: Winter test (snow level 2 to 3)



Figure 12: Winter test (snow level 4 to 5)



 OTIF	Uniform Technical Prescription (UTP)		UTP WAG
	Rolling stock - FREIGHT WAGONS		Page 143 of 148
Status: ADOPTED		TECH-20042 Annex	Original: EN
			Date: 22.6.2021

The number of ‘reference tests’ shall be at least 8 and maximum 20 for each brake initiation speed (60 km/h excluded) whereby the quotient of the standard deviation and the average braking distance shall not exceed 10 %.

The number of ‘winter tests’ shall be at least 8 (60 km/h excluded) whereby the quotient of the standard deviation and the average braking distance shall not exceed 20 % to ensure that the braking distance is representative for the assessment.

The following values shall be measured:

- Speed
- Braking distance
- Time
- Brake pipe pressure
- External temperature

8.1.2. Values to be determined in order to define the area of use

The average braking distances of the ‘winter tests’ at each speed and the average braking distances of the ‘reference tests’ shall be determined.

8.2. Dynamometer test

8.2.1. Test program to demonstrate the braking properties under severe environmental conditions

The dynamometer test program to demonstrate the extreme winter braking properties is set out in table 6 and table 7 and is only applicable if the friction element...

- ...is intended to be used in subsystems which fall under the following scope:
 - Nominal wheel diameters of 680 mm to 920 mm
 - Friction element configuration
 - 1Bg (if the test was performed in configuration 1Bg or 2Bgu)
 - 1Bgu (if the test was performed in configuration 1Bgu or 2Bgu)
 - 2Bg (if the test was performed in configuration 2Bg or 2Bgu)
 - 2Bgu (if the test was performed in configuration 2Bgu)
 - Mass per wheel ≥ 1.8 t
- ...complies with one of the following cases of the mean dynamic friction coefficient as determined in accordance with section 4.2 point b):

Table 5: Cases of the mean dynamic friction coefficient

Case	Mean dynamic friction coefficient	Total F_B per wheel	Initial speed
		F_B	v
		[kN]	[km/h]
1	$0,28 < \mu_m < 0,32$	9	100
2	$0,27 < \mu_m < 0,31$	9	120
3	$0,17 < \mu_m < 0,19$	16	100
4	$0,16 < \mu_m < 0,18$	16	120



To demonstrate the extreme winter braking properties of friction elements complying with cases 1 and 2 of table 5 the test program of table 6 shall be applied, for friction elements complying with cases 3 and 4 of table 5 the test program of table 7 shall be applied.

Table 6: Dynamometer test program – friction elements cases 1 and 2

Friction element configuration						1Bg, 1Bgu, 2Bg or 2Bgu					
Wheel type						In conformity with EN 13979-1					
Wheel diameter						$\varnothing X \pm 5$ mm last machining size before wheel is fully worn to EN 13979-1					
No. of brake application						Initial speed	Total F_B per wheel	Initial temp.	Mass to brake per wheel	Remarks	
						v	F_B	θ_0	m_{IW}		
						[km/h]	[kN]	[°C]	[t]		
R.1 - R.X						100	12	20 to 100	7,5	Brake applications to rest under dry conditions to allow bedding of the friction elements up to a contact pattern of 100 % is reached	
R.X + 1 to R.X + 20						100	12	20 to 100	2,5	20 brake applications to a stop (dry)	
1 to 5						100	9	-5 to 60	2,5	Conditioning	
6	8	10	12	14	100	9	50 to 60	2,5	Dry brake applications, warm		
7	9	11	13	15	120			2,5			
16	18	20	22	24	100	9	-5 to -3	2,5	Dry brake applications, cold (reference brake applications)		
17	19	21	23	25	120			2,5			
										Test snow machine and snow quality	
26 to 28						120	9	-5 to 90	2,5	Conditioning	
a29	a33	a37	a42	a46	20				Cooling, dry to -3°C		
b29	b33	b37	b42	b46	100				Rotating, dry, over 240 s		
c29	c33	c37	c42	c46	100				Rotating, with artificial snow over 340 s		
29	33	37	42	46	100	9		2,5	Braking with artificial snow		
30	34	38	43	47	120	9	-5 to 90	2,5	Conditioning, dry		



No. of brake application					Initial speed	Total F_B per wheel	Initial temp.	Mass to brake per wheel	Remarks
					v	F_B	θ_0	m_W	
					[km/h]	[kN]	[°C]	[t]	
a31	a35	a39	a44	a48	20				Cooling, dry to -3 °C
b31	b35	b39	b44	b48	120				Rotating, dry, over 240 s
c31	c35	c39	c44	c48	120				Rotating with artificial snow over 900 s
31	35	39	44	48	120	9		2,5	Braking with artificial snow
32	36	40	45	49	120	9	-5 to 90	2,5	Conditioning, dry
		41			120	9	-5 to 90	2,5	Conditioning, dry

Table 7: Dynamometer test program – friction elements cases 3 and 4

Friction element configuration	1Bg, 1Bgu, 2Bg or 2Bgu				
Wheel type	In conformity with EN 13979-1				
Wheel diameter	$\emptyset X \pm 5$ mm last machining size before wheel is fully worn to EN 13979-1				
No. of brake application	Initial speed	Total F_B per wheel	Initial temp.	Mass to brake per wheel	Remarks
	v	F_B	θ_0	m_{IW}	
	[km/h]	[kN]	[°C]	[t]	
R.1 - R.X	100	30	20 to 100	7,5	Brake applications to rest under dry conditions to allow bedding of the friction elements up to a contact pattern of 100 % is reached
R.X + 1 to R.X + 20	100	30	20 to 100	2,63	20 brake applications to a stop (dry)
1 to 5	100	16	-5 to 60	2,63	Conditioning



No. of brake application					Initial speed	Total F _B per wheel	Initial temp.	Mass to brake per wheel	Remarks
					v	F_B	θ_0	m_W	
					[km/h]	[kN]	[°C]	[t]	
6	8	10	12	14	100	16	50 to 60	2,63	Dry brake applications, warm
7	9	11	13	15	120			2,63	
16	18	20	22	24	100	16	-5 to -3	2,63	Dry brake applications, cold (reference brake applications)
17	19	21	23	25	120			2,63	
									Test snow machine and snow quality
26 to 28					120	16	-5 to 90	2,63	Conditioning
a29	a33	a37	a42	a46	20				Cooling, dry to -3 °C
b29	b33	b37	b42	b46	100				Rotating, dry, over 240 s
c29	c33	c37	c42	c46	100				Rotating with artificial snow over 340 s
29	33	37	42	46	100	16		2,63	Braking with artificial snow
30	34	38	43	47	120	16	-5 to 90	2,63	Conditioning, dry
a31	a35	a39	a44	a48	20				Cooling, dry to -3 °C
b31	b35	b39	b44	b48	120				Rotating, dry, over 240 s
c31	c35	c39	c44	c48	120				Rotating with artificial snow over 900 s
31	35	39	44	48	120	16		2,63	Braking with artificial snow
32	36	40	45	49	120	16	-5 to 90	2,63	Conditioning, dry
		41			120	16	-5 to 90	2,63	Conditioning, dry

During the tests described in tables 6 and 7 the following conditions shall be respected:

- The cooling air speed shall be as set out in table 8.

*Table 8: Cooling air speed*

	Speed simulated on the test bench [km/h]		Speed of the cooling air [km/h]	
	Under dry conditions	With snow	Under dry conditions	With snow
During braking	v	v	25	25
Between the brake applications	v	v	25	25

- The brake build-up time shall be $8 \text{ s} \pm 0,2 \text{ s}$.
- During bedding-in the following minimum numbers of brake stops shall be carried out: 40 for organic friction elements and 80 for sintered friction elements.
- All test equipment shall initially have a homogeneous temperature of $-7 \text{ °C} \pm 2 \text{ °C}$. The test chamber temperature shall be $-7 \text{ °C} \pm 2 \text{ °C}$. The required temperature should therefore be reached in the test chamber at least 12 h before the start of the programme (brake application n° 1).
- The snow shall be dry. Its calculated weight shall be 45 - 52 g per 250 ml measuring cup. It shall fall apart after being pressed in a palm. During the cooling periods with artificial snow and the subsequent brake applications with artificial snow, the flow of artificial snow shall not be interrupted.
- Five valid brake applications under snow (at 100 km/h and 120 km/h) are required.
- Any irregularities during testing on the friction element and the wheel contact surfaces are to be recorded and documented.
- If interruptions occur between brake applications n° 29 to 49 (e. g. due to equipment problems as a result of iced-over snow nozzles), the programme is to be continued by repeating the last conditioning brake application and the subsequent cooling operations. These interruptions are to be recorded in the test report.

8.2.2. Values to be determined in order to define the area of use

The test program shall be carried out three times and the establishment of the suitability shall be done for a maximum test speed of 100 km/h and 120 km/h as follows:

- For a maximum speed of 100 km/h the deviation of the average value of the measured stopping distances s_1 under snow (brake application n° 29, 33, 37, 42 and 46) from the average value of the measured stopping distances s_1 under dry conditions (brake application n° 16, 18, 20, 22 and 24) shall be determined.
- For a maximum speed of 120 km/h the deviation of the average value of the measured stopping distances s_1 under snow (brake application n° 31, 35, 39, 44 and 48) from the average value of the measured stopping distances s_1 under dry conditions (brake application n° 17, 19, 21, 23 and 25) shall be determined.

 OTIF	Uniform Technical Prescription (UTP)		UTP WAG
	Rolling stock - FREIGHT WAGONS		Page 148 of 148
Status: ADOPTED		TECH-20042 Annex	Original: EN
			Date: 22.6.2021

9. THERMOMECHANICAL CHARACTERISTICS

The thermomechanical analysis to be performed at subsystem level (freight wagon) is specified in the point 4.2.4.3.3 of the UTP WAG for the brake system and in the point 4.2.3.6.3 of the UTP WAG for the wheel, taking into account the area of use of the freight wagon.

At the interoperability constituent level (friction element for wheel tread brakes) it is allowed to take into account for the brake application No 129 of Table 1 a more demanding slope than those suggested in the column Remarks; the slope taken into account has then to be recorded in the technical documentation as part of the area of use of the friction element for wheel tread brakes.

At the interoperability constituent level (friction element for wheel tread brakes), in case the manufacturer chooses to perform the test to simulate 'locked brake' as specified in EN 16452:2015, the result of this test has to be recorded in the technical documentation as part of the area of use of the friction element for wheel tread brakes.