

OTIF



**ORGANISATION INTERGOUVERNEMENTALE POUR
LES TRANSPORTS INTERNATIONAUX FERROVIAIRES**

**ZWISCHENSTAATLICHE ORGANISATION FÜR DEN
INTERNATIONALEN EISENBAHNVERKEHR**

**INTERGOVERNMENTAL ORGANISATION FOR INTER-
NATIONAL CARRIAGE BY RAIL**

OTIF/RID/CE/2007/27

9 November 2007

Original: English/French/German

**RID: 44th Session of the Committee of Experts on the Transport of Dangerous Goods
(Zagreb, 19 – 23 November 2007)**

**Subject: Amendments adopted by the RID/ADR/ADN Joint Meeting in 2006 and 2007 and
by the RID Committee of Experts Meeting in 2006**

transmitted by the Secretariat of OTIF

For reasons of cost, only a limited number of copies of this document have been made. Delegates are asked to bring their own copies of documents to meetings. OTIF only has a small number of copies available.

Tel. (+41) 31 - 359 10 17 • Fax (+41) 31 - 359 10 11 • E-Mail info@otif.org • Gryphenhübeliweg 30 • CH - 3006 Berne/Bern

TABLE OF CONTENTS

- 1.1.3.4 Replace "in limited quantities" with:
"in limited or excepted quantities".
- 1.3.2.4 Delete.
- 1.7.1 Amend to read as follows:
"Scope and application".
- 2.2.7 Amend the whole section to read as follows:
"2.2.7 Class 7: Radioactive material"
- 2.2.7.1 Definitions
- 2.2.7.2 Classification
 - 2.2.7.2.1 General provisions
 - 2.2.7.2.2 Determination of activity levels
 - 2.2.7.2.3 Determination of other material characteristics
 - 2.2.7.2.4 Classification of packages or unpacked material
 - 2.2.7.2.5 Special arrangements"
- Part 3** Amend to read as follows:
"Dangerous goods lists, special provisions and exemptions related to limited and excepted quantities"
- 3.4 Amend to read as follows:
"Dangerous goods packed in limited quantities".
Insert the following new Chapter 3.5:
"3.5 Dangerous goods packed in excepted quantities"
- 3.5.1 Excepted quantities
- 3.5.2 Packagings
- 3.5.3 Tests for packages
- 3.5.4 Marking of packages
- 3.5.5 Maximum number of packages in any wagon or container
- 3.5.6 Documentation".

- 6.2 Amend the whole Chapter to read as follows:
 - "6.2 Requirements for the construction and testing of pressure receptacles, aerosol dispensers, small receptacles containing gas (gas cartridges) and fuel cell cartridges containing liquefied flammable gas**
[Ref. doc.: ST/SG/AC.10/C.3/2006/82]
 - 6.2.1 General requirements
 - 6.2.1.1 Design and construction
 - 6.2.1.2 Materials
 - 6.2.1.3 Service equipment
 - 6.2.1.4 Approval of pressure receptacles
 - 6.2.1.5 Initial inspection and test
 - 6.2.1.6 Periodic inspection and test
 - 6.2.1.7 Requirements for manufacturers
 - 6.2.1.8 Requirements for inspection bodies
 - 6.2.2 Requirements for UN pressure receptacles
 - 6.2.2.1 Design, construction and initial inspection and test
 - 6.2.2.2 Materials
 - 6.2.2.3 Service equipment
 - 6.2.2.4 Periodic inspection and test
 - 6.2.2.5 Conformity assessment system and approval for manufacture of pressure receptacles
 - 6.2.2.6 Approval system for periodic inspection and test of pressure receptacles
 - 6.2.2.7 Marking of refillable UN pressure receptacles
 - 6.2.2.8 Marking of non-refillable UN pressure receptacles
 - 6.2.2.9 Equivalent procedures for conformity assessment and periodic inspection and test
 - 6.2.3 General requirements for non-UN pressure receptacles
 - 6.2.3.1 Design and construction
 - 6.2.3.2 (Reserved)
 - 6.2.3.3 Service equipment
 - 6.2.3.4 Initial inspection and test

- 6.2.3.5** Periodic inspection and test
- 6.2.3.6** Approval of pressure receptacles
- 6.2.3.7** Requirements for manufacturers
- 6.2.3.8** Requirements for inspection bodies
- 6.2.3.9** Marking of refillable pressure receptacles
- 6.2.3.10** Marking of non-refillable pressure receptacles
- 6.2.4** Requirements for non-UN pressure receptacles designed, constructed and tested according to standards
- 6.2.5** Requirements for non-UN pressure receptacles not designed, constructed and tested according to standards
 - 6.2.5.1** Materials
 - 6.2.5.2** Service equipment
 - 6.2.5.3** Metal cylinders, tubes, pressure drums and bundles of cylinders
 - 6.2.5.4** Additional provisions relating to aluminium-alloy pressure receptacles for compressed gases, liquefied gases, dissolved gases and non pressurized gases subject to special requirements (gas samples) as well as articles containing gas under pressure other than aerosol dispensers and small receptacles containing gas (gas cartridges)
 - 6.2.5.5** Pressure receptacles in composite materials
 - 6.2.5.6** Closed cryogenic receptacles
- 6.2.6** General requirements for aerosol dispensers, small receptacles containing gas (gas cartridges) and fuel cell cartridges containing liquefied flammable gas
[Ref. doc.: ST/SG/AC.10/C.3/2006/82]
 - 6.2.6.1** Design and construction
 - 6.2.6.2** Hydraulic pressure test
 - 6.2.6.3** Tightness (leakproofness) test
 - 6.2.6.4** Reference to standards".
- 6.3** Replace "substances" with:
"infectious substances of Category A".
- 6.3.2** Amend to read as follows:
"Requirements for packagings".

6.3.3 Amend to read as follows:
"Code for designating types of packagings".
Insert the following new 6.3.4 and 6.3.5:

"6.3.4 Marking

6.3.5 Test requirements for packagings".

6.5.6.13 Amend to read as follows:

"Vibration test".

Insert the following new 6.5.6.14:

"6.5.6.14 Test report".

PART 1

Chapter 1.1

1.1.3.1 In paragraph (a), add a new second sentence to read as follows:

"When these goods are flammable liquids carried in refillable receptacles filled by, or for, a private individual, the total quantity shall not exceed 60 litres per receptacle."

[Ref. doc.: ECE/TRANS/WP.15/AC.1/2007/22/Rev.1 + INF.62 JM 09/07]

In the Note, replace "2.2.7.1.2" with:

"1.7.1.4".

[Consequential amendment in relation with 1.7.1.4]

1.1.3.2 (c) Amend the first sentence to read as follows:

"gases of Groups A and O (according to 2.2.2.1), if the pressure of the gas in the receptacle or tank at a temperature of 20 °C does not exceed 200 kPa (2 bar) and if the gas is not a liquefied or a refrigerated liquefied gas."

1.1.3.4 In the heading, replace "in limited quantities" with:

"in limited or excepted quantities".

1.1.3.4.2 Move the Note after the title of 1.1.3.4 and replace "2.2.7.1.2" with:

"1.7.1.4".

[Consequential amendment in relation with 1.7.1.4]

1.1.3.4.2 Delete:

"packed in limited quantities".

Insert a new paragraph 1.1.3.4.3 to read as follows:

"1.1.3.4.3 Certain dangerous goods may be subject to exemptions provided that the conditions of Chapter 3.5 are met."

1.1.3.6.3 In the Table, for Transport category 3, insert a new line in column (2) to read as follows:

"Class 4.3: UN No. 3476".

For Transport category 3, in column (2), for Class 8, replace "and 3028" with:

", 3028 and 3477".

Amend the first indent after the Table to read as follows:

"– for articles, gross mass in kilograms (for articles of Class 1, net mass in kg of the explosive substance; for dangerous goods in machinery and equipment specified in RID, the total quantity of dangerous goods contained therein in kilograms or litres as appropriate);".

[Ref. doc.: ECE/TRANS/WP.15/AC.1/2007/24 as amended]

Add a new sub-section 1.1.3.7 to read as follows:

"1.1.3.7 Exemptions related to the carriage of lithium batteries

The provisions laid down in RID do not apply to:

- (a) Lithium batteries installed in a means of transport, performing a transport operation and destined for its propulsion or for the operation of any of its equipment;
- (b) Lithium batteries contained in equipment for the operation of this equipment used or intended for use during carriage (e.g. a laptop)."

[Ref. doc.: ECE/TRANS/WP.15/AC.1/2007/14 + INF.41 JM 03/07 as amended]

Chapter 1.2

1.2.1 In the definition for "**Aerosol or aerosol dispenser**", replace "6.2.4" with:

"6.2.6".

[Ref. doc.: INF.32 JM 03/07]

In the definition of "**Container**":

- Add a new fifth indent to read as follows:

"– having an internal volume of not less than 1 m³, except for containers for the carriage of radioactive material."

- Before "A swap body", delete:

"(see also "*Closed container*", "*Large container*", "*Open container*", "*Sheeted container*" and "*Small container*")".

- At the end of the definition, add a new paragraph to read as follows:

"In addition:" followed by the existing definitions of "*Small container* (as amended, see below)", "*Large container*" (as amended, see below), "*Closed container*", "*Open container*" and "*Sheeted container*".

At the places where the definitions of "*Open container*", "*Closed container*", "*Large container*", "*Sheeted container*" and "*Small container*" currently appear, replace the definition with:

", see "*Container*"."

- In the Note after the definition add:

"Nevertheless, a container may be used as a packaging for the carriage of radioactive material."

In the definition of "**Composite IBC with plastics inner receptacle**", add the following new note:

"NOTE: "Plastics material", when used in connection with inner receptacles for composite IBCs, is taken to include other polymeric materials such as rubber."

[Consequential amendment, see under 6.5.5.4.6]

In the Note after the definition of "**Full load**", delete:

", see 2.2.7.2". "exclusive use" shall appear in italics.

In the definition of "**Large container**", amend (a) to read as follows:

"(a) a *container* which does not meet the definition of a *small container*,".

In the definition of "**Maximum working pressure**", Note 2, replace "6.2.1.3.3.5" with:

"6.2.1.3.6.5".

[Ref. doc.: ECE/TRANS/WP.15/AC.1/2007/18]

Amend the definition of "**Small container**" to read as follows:

"Small container" means a container which has either any overall outer dimension (length, width or height) less than 1.5 m, or an internal volume of not more than 3 m³."

In the definition of "**Packaging**", amend the text before the parenthesis to read as follows:

"Packaging" means one or more *receptacles* and any other components or materials necessary for the *receptacles* to perform their containment and other safety functions."

Delete the Note after the definitions of "**Package**", "**Packaging**", "**Large container**" and "**Small container**".

In the Note after the definition of "**Wagon load**", delete:

", see 2.2.7.2". "exclusive use" shall appear in italics.

Insert the following new definitions in alphabetical order:

"ADN" means the European Agreement concerning the International Carriage of *Dangerous Goods* by Inland Waterways;

[Ref. doc.: ECE/TRANS/WP.15/AC.1/2007/32, consequential amendment]

"Animal material" means animal carcasses, animal body parts, or animal food-stuffs;

"Applicant" means, in the case of conformity assessment, the manufacturer or its authorised representative in a Member State. In the case of periodic testing and exceptional checks, *applicant* means the testing facility, the operator or their authorised representative in a Member State;

NOTE: Exceptionally a third party (for instance an operator in accordance with the definition of 1.2.1) may apply for the conformity assessment.

"Approval"

"Multilateral approval", for the carriage of Class 7 material, means approval by the relevant competent authority of the country of origin of the *design* or shipment, as applicable, and by the *competent authority* of each country through or into which the consignment is to be carried. The term "through or into" specifically excludes "over", i.e. the approval and notification requirements shall not apply to a country over which radioactive material is carried in an aircraft, provided that there is no scheduled stop in that country;

"Unilateral approval", for the carriage of Class 7 material, means an approval of a *design* which is required to be given by the *competent authority* of the country of origin of the *design* only.

If the country of origin is not a COTIF Member State, the approval shall require validation by the *competent authority* of the first COTIF Member State reached by the consignment (see 6.4.22.6);

"Confinement system", for the carriage of Class 7 material, means the assembly of fissile material and packaging components specified by the designer and agreed to by the *competent authority* as intended to preserve criticality safety;

"Conformity assessment" means the process of verifying the conformity of a product according to the provisions of sections 1.8.6 and 1.8.7 related to type approval, supervision of manufacture and initial inspection and testing;

[Ref. doc.: ECE/TRANS/WP.15/AC.1/2007/18 + INF.23 JM 03/07 + INF.46 JM 03/07]

"Containment system", for the carriage of Class 7 material, means the assembly of components of the *packaging* specified by the designer as intended to retain the radioactive material during *carriage*;

"Criticality safety index (CSI)" assigned to a package, overpack or container containing fissile material, for the carriage of Class 7 material, means a number which is

used to provide control over the accumulation of *packages, overpacks* or *containers* containing fissile material;

"Design", for the carriage of Class 7 material, means the description of special form radioactive material, low dispersible radioactive material, *package* or *packaging* which enables such an item to be fully identified. The description may include specifications, engineering drawings, reports demonstrating compliance with regulatory requirements, and other relevant documentation;

"Exclusive use", for the carriage of Class 7 material, means the sole use, by a single consignor, of a *wagon* or of a *large container*, in respect of which all initial, intermediate and final loading and unloading is carried out in accordance with the directions of the *consignor* or *consignee*;

[Consequential amendments see under definition of "Full load" and "Wagon load".]

"Maximum normal operating pressure", for the carriage of Class 7 material, means the maximum pressure above atmospheric pressure at mean sea-level that would develop in the *containment system* in a period of one year under the conditions of temperature and solar radiation corresponding to environmental conditions in the absence of venting, external cooling by an ancillary system, or operational controls during *carriage*;

"Radiation level", for the carriage of Class 7 material, means the corresponding dose rate expressed in millisieverts per hour;

"Radioactive contents", for the carriage of Class 7 material, mean the radioactive material together with any contaminated or activated *solids, liquids, and gases* within the *packaging*;

"Transport index (TI)" assigned to a package, overpack or container, or to unpackaged LSA-I or SCO-I, for the carriage of Class 7 material, means a number which is used to provide control over radiation exposure;"

Chapter 1.3

1.3.1 Current Note becomes Note 1. Add the following new notes:

"2: (Reserved)

3: For training with regard to Class 7, see also 1.7.2.7.

4: The training shall be effected before taking on responsibilities concerning the carriage of dangerous goods."

[Ref. doc.: INF.18 JM 09/07 as amended + ECE/TRANS/WP.15/AC.1/2007/5 as amended]

1.3.2.4 Delete.

Chapter 1.4

1.4.2.2.1 (d) Add a new note at the end to read as follows:

"NOTE: Tanks, battery-wagons and MEGCs may however be carried after the expiry of this date under the conditions of 4.1.6.10 (in the case of battery-wagons and MEGCs containing pressure receptacles as elements), 4.2.4.4, 4.3.2.4.4, 6.7.2.19.6, 6.7.3.15.6 or 6.7.4.14.6."

[Ref. doc.: TRANS/WP.15/AC.1/2006/18 + INF.34 JM 09/06 + INF.45 JM 09/07+ INF.52 JM 09/07]

Chapter 1.6

1.6.1 Add the following new transitional measures:

"1.6.1.13 Plates in accordance with the provisions of 5.3.2.2.1 and 5.3.2.2.2 applicable until 31 December 2008 may be used until 31 December 2009.

[Ref. doc.: INF.24 JM 03/07]

1.6.1.14 IBCs manufactured before 1 January 2011 in accordance with the requirements in force up to 31 December 2010 and conforming to a design type which has not passed the vibration test of 6.5.6.13 may still be used.

1.6.1.15 IBCs manufactured, remanufactured or repaired before 1 January 2011 need not be marked with the maximum permitted stacking load in accordance with 6.5.2.2.2. Such IBCs, not marked in accordance with 6.5.2.2.2, may still be used after 31 December 2010 but must be marked in accordance with 6.5.2.2.2 if they are remanufactured or repaired after that date.

[Ref. doc. INF.46 JM 09/07]

1.6.1.16 Animal material affected by pathogens included in Category B, other than those which would be assigned to Category A if they were in culture (see 2.2.62.1.12.2), may be carried in accordance with provisions determined by the competent authority until 31 December 2014.*

* Regulations for dead infected animals are contained e.g. in Regulation (EC) No. 1774/2002 of the European Parliament and of the Council of 3 October 2002 laying down health rules concerning animal by-products not intended for human consumption (Official Journal of the European Communities, No. L 273 of 10 October 2002, p. 1).

1.6.1.17 Substances of classes 1 to 9 other than those assigned to UN Nos. 3077 or 3082 to which the classification criteria of 2.2.9.1.10 have not been applied and which are not marked in accordance with 5.2.1.8 and 5.3.6 may still be carried until 31 December 2010 without application of the provisions concerning the carriage of environmentally hazardous substances.

[Ref. doc.: INF.58 JM 09/07]

1.6.1.18 The provisions of sections 3.4.9 to 3.4.12 need only be applied as from 1 January 2011."

[Ref. doc.: ECE/TRANS/WP.15/AC.1/2007/60 as amended]

- 1.6.2** Amend the heading to read as follows:
- "Pressure receptacles and receptacles for class 2".
- [Ref. doc.: TRANS/WP.15/AC.1/2006/15 + TRANS/WP.15/AC.1/2006/30 + INF.35 JM 09/06 as amended]
- 1.6.2.4** Replace "6.2.3" with:
- "6.2.5".
- [Ref. doc.: INF.32 JM 03/07]
- 1.6.2.5** Replace "but no longer listed in 6.2.2 or 6.2.5" with:
- "(see 6.2.4) according to the provisions of RID which were applicable at that time".
- [Ref. doc.: INF.44/Rev.1 JM 09/07]
- 1.6.2.6** Add a new transitional measure to read as follows:
- "1.6.2.6** Pressure receptacles for substances other than those of class 2, built before 1 July 2009 in accordance with the requirements of 4.1.4.4 in force up to 31 December 2008, but which do not conform to the requirements of 4.1.3.6 applicable as from 1 January 2009, may continue to be used provided that the requirements of 4.1.4.4 in force up to 31 December 2008 are complied with."
- [Ref. doc.: TRANS/WP.15/AC.1/2006/15 + TRANS/WP.15/AC.1/2006/30 + INF.35 JM 09/06 as amended]
- 1.6.3.31** Amend to read as follows:
- "1.6.3.31** Tank-wagons designed and constructed in accordance with a technical code which was recognized at the time of their construction according to the provisions of 6.8.2.7 which were applicable at that time may still be used."
- [Ref. doc.: ECE/TRANS/WP.15/AC.1/2007/55]
- 1.6.4.9** Amend to read as follows:
- "1.6.4.9** Tank-containers designed and constructed in accordance with a technical code which was recognized at the time of their construction according to the provisions of 6.8.2.7 which were applicable at that time may still be used."
- [Ref. doc.: ECE/TRANS/WP.15/AC.1/2007/55]
- Add the following new transitional measures:
- "1.6.4.31** For substances where TP 35 is assigned in column (11) of Table A of Chapter 3.2, portable tank instruction T 14 prescribed in RID applicable up to 31 December 2008 may continue to be applied until 31 December 2014.
- 1.6.4.32** When the shell of a tank-container was already divided by partitions or surge plates into sections of not more than 7 500 litres capacity before 1 January 2009, the capacity of the shell need not be supplemented with the symbol "S" in the particulars required by 6.8.2.5.1 until the next periodic inspection according to 6.8.2.4.2 is performed.

[Ref. doc.: ECE/TRANS/WP.15/AC.1/2007/29 + INF.52 JM 09/07]

- 1.6.4.33** Notwithstanding the provisions of 4.3.2.2.4, tank-containers intended for the carriage of liquefied gases or refrigerated liquefied gases, which meet the applicable construction requirements of RID but which were divided, before 1 July 2009, by partitions or surge plates into sections of more than 7 500 litres capacity may still be filled to more than 20% and less than 80% of their capacity."

[Ref. doc.: INF.11 JM 09/07 + INF.52 JM 09/07 + INF.53 JM 09/07]

- 1.6.6.1** In the first sub-paragraph, replace "2.2.7.7" with:

"2.2.7.2.2, 2.2.7.2.4.1, 2.2.7.2.4.4, 2.2.7.2.4.5, 2.2.7.2.4.6, special provision 336 of Chapter 3.3 and 4.1.9.3".

[Consequential amendment; ref. doc.: INF.18 JM 09/07]

- 1.6.6.2.1 and**

- 1.6.6.2.2** Replace "2.2.7.7" with:

"2.2.7.2.2, 2.2.7.2.4.1, 2.2.7.2.4.4, 2.2.7.2.4.5, 2.2.7.2.4.6, special provision 337 of Chapter 3.3 and 4.1.9.3".

[Consequential amendment; ref. doc.: INF.18 JM 09/07]

Chapter 1.7

In the heading of the Chapter, replace "requirements" with "provisions".

- 1.7.1** Amend the heading to read as follows:

"1.7.1 Scope and application".

Add the following notes under the heading:

"NOTE 1: In the event of accidents or incidents during the carriage of radioactive material, emergency provisions, as established by relevant national and/or international organizations, shall be observed to protect persons, property and the environment. Appropriate guidelines for such provisions are contained in "Planning and Preparing for Emergency Response to Transport Accidents Involving Radioactive Material", Safety Standard Series No. TS-G-1.2 (ST-3), IAEA, Vienna (2002).

2: Emergency procedures shall take into account the formation of other dangerous substances that may result from the reaction between the contents of a consignment and the environment in the event of an accident."

- 1.7.1.1** [Unchanged. The reference to TS-G-1.1 need to be updated when the revised edition will be published by IAEA.]

1.7.1.4 Insert new sub-sections 1.7.1.4 and 1.7.1.5 to read as follows:

"1.7.1.4 The provisions laid down in RID do not apply to the carriage of:

- (a) Radioactive material that is an integral part of the means of transport;
- (b) Radioactive material moved within an establishment which is subject to appropriate safety regulations in force in the establishment and where the movement does not involve public roads or railways;
- (c) Radioactive material implanted or incorporated into a person or live animal for diagnosis or treatment;
- (d) Radioactive material in consumer products which have received regulatory approval, following their sale to the end user;
- (e) Natural material and ores containing naturally occurring radionuclides which are either in their natural state, or have only been processed for purposes other than for extraction of the radionuclides, and which are not intended to be processed for use of these radionuclides provided the activity concentration of the material does not exceed 10 times the values specified in 2.2.7.2.2.1 (b), or calculated in accordance with 2.2.7.2.2.2 to 2.2.7.2.2.6;
- (f) Non-radioactive solid objects with radioactive substances present on any surfaces in quantities not in excess of the limit set out in the definition for "contamination" in 2.2.7.1.2.

[Consequential amendments see under 1.1.3.1, 1.1.3.4.1 and 1.8.3.2]

1.7.1.5 **Specific provisions for the carriage of excepted packages**

Excepted packages as specified in 2.2.7.2.4.1 shall be subject only to the following provisions of Parts 5 to 7:

- (a) The applicable requirements in 5.1.2, 5.1.3.2, 5.1.4, 5.2.1.2, 5.2.1.7.1 to 5.2.1.7.3, 5.2.1.9, 5.4.1.1.1 (a), (g) and (h) and 7.5.11 CW 33 (5.2);
- (b) The requirements for excepted packages specified in 6.4.4; and
- (c) If the excepted package contains fissile material, one of the fissile exceptions provided by 2.2.7.2.3.5 shall apply and the requirement of 6.4.7.2 shall be met.

Excepted packages are subject to the relevant provisions of all other parts of RID."

[Ref. doc.: ECE/TRANS/WP.15/AC.1/2007/58 as amended]

[Consequential amendment see under Chapter 3.3 special provision 290]

Amend 1.7.2.2 and 1.7.2.3 to read as follows:

"1.7.2.2 Doses to persons shall be below the relevant dose limits. Protection and safety shall be optimized in order that the magnitude of individual doses, the number of persons exposed, and the likelihood of incurring exposure shall be kept as low as reasonably achievable, economic and social factors being taken into account within the restriction that the doses to individuals be subject to dose constraints. A structured and systematic approach shall be adopted and shall include consideration of the interfaces between carriage and other activities.

1.7.2.3 The nature and extent of the measures to be employed in the programme shall be related to the magnitude and likelihood of radiation exposures. The programme shall incorporate the requirements in 1.7.2.2, 1.7.2.4 to 1.7.2.7. Programme documents shall be available, on request, for inspection by the relevant competent authority."

1.7.2.4 Add the following new note at the end:

"NOTE: For occupational exposures arising from transport activities, where it is assessed that the effective dose is most unlikely to exceed 1 mSv in a year, no special work patterns, detailed monitoring, dose assessment programmes or individual record keeping need be required."

Add the following new 1.7.2.5:

"1.7.2.5 Workers (see 7.5.11, CW 33 Note 3) shall receive appropriate training concerning radiation protection including the precautions to be observed in order to restrict their occupational exposure and the exposure of other persons who might be affected by their actions."

[Ref. doc.: INF.18 JM 09/07]

1.7.4.1 Delete "of radioactive material" after "consignments" and replace "the applicable requirements of RID" with "the requirements of RID applicable to radioactive material".

Chapter 1.8

1.8.3.2 In paragraph (b), replace "2.2.7.1.2 and in Chapters 3.3 and 3.4" with:

"1.7.1.4 and in Chapters 3.3, 3.4 und 3.5".

[Consequential amendment in relation with 1.7.1.4]

Add the following new sections 1.8.6 and 1.8.7:

"1.8.6 **Administrative controls for application of the conformity assessments, periodic inspections, and exceptional checks described in 1.8.7**

1.8.6.1 The competent authority may approve inspection bodies for conformity assessments, periodic inspections, exceptional checks and surveillance of the in-house inspection service as specified in section 1.8.7.

[Ref. doc.: INF.32 JM 09/07]

1.8.6.2 The competent authority shall ensure the monitoring of the inspection bodies and shall revoke or restrict the approval given, if it notes that an approved body is no longer in compliance with the approval and the requirements of 1.8.6.4 or does not follow the procedures specified in the provisions of RID.

1.8.6.3 If the approval is revoked or restricted or when the inspection body has ceased activity, the competent authority shall take the appropriate steps to ensure that the files are either processed by another inspection body or kept available.

1.8.6.4

The inspection body shall:

- (a) Have a staff with an organisational structure, capable, trained, competent and skilled, to satisfactorily perform its technical functions;
- (b) Have access to suitable and adequate facilities and equipment;
- (c) Operate in an impartial manner and be free from any influence which could prevent it from doing so;
- (d) Ensure commercial confidentiality of the commercial and proprietary activities of the manufacturer and other bodies;
- (e) Maintain clear demarcation between actual inspection body functions and unrelated functions;
- (f) Have a documented quality system;
- (g) Ensure that the tests and inspections specified in the relevant standard and in RID are performed; and
- (h) Maintain an effective and appropriate report and record system in accordance with 1.8.7.

The inspection body shall additionally be accredited according to the standard EN ISO/IEC 17020:2004, as specified in 6.2.3.6 and TA4 and TT9 of 6.8.4.

An inspection body starting a new activity may be approved temporarily. Before temporary designation, the competent authority shall ensure that the inspection body meets the requirements of the standard EN ISO/IEC 17020:2004. The inspection body shall be accredited in its first year of activity to be able to continue this new activity.

1.8.7

Procedures for conformity assessment and periodic inspection

NOTE: In this section, "relevant body" means a body assigned in 6.2.2.9 when certifying UN pressure receptacles, in 6.2.3.6 when approving non-UN pressure receptacles and in special provisions TA4 and TT9 of 6.8.4.

1.8.7.1

General provisions

1.8.7.1.1

The procedures in section 1.8.7 shall be applied according to the Table in 6.2.3.6 when approving non-UN pressure receptacles and according to TA4 and TT9 of 6.8.4 when approving tanks, battery-wagons and MEGCs.

The procedures in section 1.8.7 may be applied according to the Table in 6.2.2.9 when certifying UN pressure receptacles.

1.8.7.1.2

Each application for

- (a) The type approval in accordance with 1.8.7.2 or;
- (b) The supervision of manufacture in accordance with 1.8.7.3 and the initial inspection and test in accordance with 1.8.7.4; or
- (c) The periodic inspection and exceptional checks in accordance with 1.8.7.5

shall be lodged by the applicant with a single competent authority, its delegate or an approved inspection body of his choice.

1.8.7.1.3 The application shall include:

- (a) The name and address of the applicant;
- (b) For conformity assessment where the applicant is not the manufacturer, the name and address of the manufacturer;
- (c) A written declaration that the same application has not been lodged with any other competent authority, its delegate or inspection body;
- (d) The relevant technical documentation specified in 1.8.7.7;
- (e) A statement allowing the competent authority, its delegate or inspection body access for inspection purposes to the locations of manufacture, inspection, testing and storage and providing it with all necessary information.

1.8.7.1.4 Where the applicant can demonstrate to the satisfaction of the competent authority or its delegated inspection body conformity with 1.8.7.6 the applicant may establish an in-house inspection service which may perform part or all of the inspections and tests when specified in 6.2.2.9 or 6.2.3.6.

[Ref. doc.: INF.32 JM 09/07]

1.8.7.2 Type approval

1.8.7.2.1 The applicant shall:

- (a) In the case of pressure receptacles, place at the disposal of the relevant body representative samples of the production envisaged. The relevant body may request further samples if required by the test programme;
- (b) In the case of tanks, battery-wagons or MEGCs, give access to the prototype for type testing.

1.8.7.2.2 The relevant body shall:

- (a) Examine the technical documentation specified in 1.8.7.7.1 to verify that the design is in accordance with the relevant provisions of RID, and the prototype or the prototype lot has been manufactured in conformity with the technical documentation and is representative of the design;
- (b) Perform the examinations and witness the tests specified in RID, to determine that the provisions have been applied and fulfilled, and the procedures adopted by the manufacturer meet the requirements;
- (c) Check the certificate(s) issued by the materials manufacturer(s) against the relevant provisions of RID;
- (d) As applicable, approve the procedures for the permanent joining of parts or check that they have been previously approved, and verify that the staff undertaking the permanent joining of parts and the non-destructive tests are qualified or approved;

- (e) Agree with the applicant the location and testing facilities where the examinations and necessary tests are to be carried out.

The relevant body shall issue a type-examination report to the applicant.

1.8.7.2.3 Where the type satisfies all applicable provisions, the competent authority, its delegate or the inspection body, shall issue a type approval certificate.

This certificate shall contain:

- (a) The name and address of the issuer;
- (b) The name and address of the manufacturer;
- (c) A reference to the version of RID and standards used for the type examination;
- (d) Any requirements resulting from the examination;
- (e) The necessary data for identification of the type and variation, as defined by the relevant standard; and
- (f) The reference to the type examination report(s).

A list of the relevant parts of the technical documentation shall be annexed to the certificate (see 1.8.7.7.1).

1.8.7.3 Supervision of manufacture

1.8.7.3.1 The manufacturing process shall be subject to a survey by the relevant body to ensure the product is produced in conformity with the provisions of the type approval.

1.8.7.3.2 The applicant shall take all the necessary measures to ensure that the manufacturing process complies with the applicable provisions of RID and of the type approval certificate and its annexes.

1.8.7.3.3 The relevant body shall:

- (a) Verify the conformity with the technical documentation specified in 1.8.7.7.2;
- (b) Verify that the manufacturing process produces products in conformity with the requirements and the documentation which apply to it;
- (c) Verify the traceability of materials and check the material certificate(s) against the specifications;
- (d) As applicable, verify that the personnel undertaking the permanent joining of parts and the non-destructive tests are qualified or approved;
- (e) Agree with the applicant on the location where the examinations and necessary tests are to be carried out; and
- (f) Record the results of its survey.

1.8.7.4 Initial inspection and tests

1.8.7.4.1 The applicant shall:

- (a) Affix the marks specified in RID; and
- (b) Supply to the relevant body the technical documentation specified in 1.8.7.7.

1.8.7.4.2 The relevant body shall:

- (a) Perform the necessary examinations and tests in order to verify that the product is manufactured in accordance with the type approval and the relevant provisions;
- (b) Check the certificates supplied by the manufacturers of service equipment against the service equipment;
- (c) Issue an initial inspection and test report to the applicant relating to the detailed tests and verifications carried out and the verified technical documentation; and
- (d) Draw up a written certificate of conformity of the manufacture and affix its registered mark when the manufacture satisfies the provisions.

The certificate and report may cover a number of items of the same type (group certificate or report).

1.8.7.4.3 The certificate shall contain as a minimum:

- (a) The name and address of the relevant body;
- (b) The name and address of the manufacturer and the name and address of the applicant, if not the manufacturer;
- (c) A reference to the version of the RID and standards used for the initial inspections and tests;
- (d) The results of the inspections and tests;
- (e) The data for identification of the inspected product(s), at least the serial number or for non refillable cylinders the batch number; and
- (f) The type approval number.

1.8.7.5 Periodic inspection and exceptional checks

The relevant body shall:

- (a) Perform the identification and verify the conformity with the documentation;
- (b) Carry out the inspections and witness the tests in order to check that the requirements are met;
- (c) Issue reports of the results of the inspections and tests, which may cover a number of items; and
- (d) Ensure that the required marks are applied.

1.8.7.6 Surveillance of the applicant's in-house inspection service

1.8.7.6.1 The applicant shall:

- (a) Implement an in-house inspection service with a quality system for inspections and tests documented in 1.8.7.7.5 and subject to surveillance;
- (b) Fulfil the obligations arising out of the quality system as approved and to ensure that it remains satisfactory and efficient;
- (c) Appoint trained and competent personnel for the in-house inspection service; and
- (d) Affix the registered mark of the inspection body where appropriate.

1.8.7.6.2 The inspection body shall carry out an initial audit. If satisfactory the inspection body shall issue an authorisation for a period not exceeding three years. The following provisions shall be met:

- (a) This audit shall confirm that the inspections and tests performed on the product are in compliance with the requirements of RID;
- (b) The inspection body may authorise the in-house inspection service of the applicant to affix the registered mark of the inspection body to each approved product;
- (c) The authorisation may be renewed after a satisfactory audit in the last year prior to the expiry. The new period of validity shall begin with the date of expiry of the authorisation; and
- (d) The auditors of the inspection body shall be competent to carry out the assessment of conformity of the product covered by the quality system.

1.8.7.6.3 The inspection body shall carry out periodic audits within the duration of the authorisation to make sure that the applicant maintains and applies the quality system. The following provisions shall be met:

- (a) A minimum of two audits shall be carried out in a 12 month period;
- (b) The inspection body may require additional visits, training, technical changes, modifications of the quality system, restrict or prohibit the inspections and tests to be done by the applicant;
- (c) The inspection body shall assess any changes in the system and decide whether the modified quality system will still satisfy the requirements of the initial audit or whether a full reassessment is required;
- (d) The auditors of the inspection body shall be competent to carry out the assessment of conformity of the product covered by the quality system; and
- (e) The inspection body shall provide the applicant with a visit or audit report and, if a test has taken place, with a test report.

1.8.7.6.4 In cases of non conformity with the relevant requirements the inspection body shall ensure that corrective measures are taken. If corrective measures are not taken in due time, the inspection body shall suspend or withdraw the permission for the in-house inspection service to carry out its activities. The notice of suspension or with-

drawal shall be transmitted to the competent authority. A report shall be provided to the applicant giving detailed reasons for the decisions taken by the inspection body.

1.8.7.7 Documents

The technical documentation shall enable an assessment to be made of conformity with the relevant requirements.

1.8.7.7.1 Documents for type approval

The applicant shall provide as appropriate:

- (a) The list of standards used for the design and manufacture;
- (b) A description of the type including all variations;
- (c) The instructions according to the relevant column of Table A of Chapter 3.2 or a list of dangerous goods to be transported for dedicated products;
- (d) A general assembly drawing or drawings;
- (e) The detailed drawings including the dimensions used for the calculations of the product, the service equipment, the structural equipment, the marking and/or the labelling necessary to verify the conformity;
- (f) The calculation notes, results and conclusions;
- (g) The list of the service equipment with the relevant technical data and information on the safety devices including the calculation of the relief capacity if relevant;

[Ref. doc.: INF.8 JM 09/07 as amended]

- (h) The list of material requested in the standard for manufacture used for every part, sub-part, lining, service and structural equipment and the corresponding material specifications or the corresponding declaration of conformity to RID;
- (i) The approved qualification of permanent joining process;
- (j) The description of the heat treatment process(es); and
- (k) The procedures, descriptions and records of all relevant tests listed in the standards or RID for the type approval and for the manufacture.

1.8.7.7.2 Documents for the supervision of manufacture

The applicant shall make available as appropriate:

- (a) The documents listed in 1.8.7.7.1;
- (b) The manufacturing procedures including test procedures;
- (c) The manufacturing records;
- (d) The approved qualifications of permanent joining operators;
- (e) The approved qualifications of the non destructive test operators;

- (f) The reports of the destructive and non destructive tests;
- (g) The heat treatment records; and
- (h) The calibration records.

1.8.7.7.3 Documents for initial inspection and tests

The applicant shall make available as appropriate:

- (a) The documents listed in 1.8.7.7.1 and 1.8.7.7.2;
- (b) The material certificates of the product and any sub-parts;
- (c) The declarations of conformity and material certificates of the service equipment; and
- (d) A declaration of conformity including the description of the product and all the variations adopted from the type approval.

1.8.7.7.4 Documents for periodic inspections and exceptional checks

The applicant shall make available as appropriate:

- (a) For pressure receptacles, the documents specifying special requirements when the manufacturing and periodic inspections and tests standards so require;
- (b) For tanks;
 - (i) the tank record; and
 - (ii) one or more of the documents mentioned in 1.8.7.7.1 to 1.8.7.7.3.

1.8.7.7.5 Documents for the assessment of in-house inspection service

The applicant for in-house inspection service shall make available the quality system documentation as appropriate:

- (a) The organisational structure and responsibilities;
- (b) The relevant inspection and test, quality control, quality assurance and process operation instructions, and systematic actions that will be used;
- (c) The quality records, such as inspection reports, test data, calibration data and certificates;
- (d) The management reviews to ensure the effective operation of the quality system arising from the audits in accordance with 1.8.7.6;
- (e) The process describing how customer and regulation requirements are met;
- (f) The process for control of documents and their revision;
- (g) The procedures for dealing with non-conforming products; and
- (h) The training programmes and qualification procedures for relevant personnel.

1.8.7.8 Products manufactured, approved, inspected and tested according to standards

The requirements of 1.8.7.7 are considered to have been complied with if the following standards, as relevant, are applied:

Applicable subsection and paragraph	References	Title of the document
1.8.7.7.1 to 1.8.7.7.4	EN 12972:2007	Tanks for transport of dangerous goods – Testing, inspection and marking of metallic tanks

[Ref. doc.: ECE/TRANS/WP.15/AC.1/2007/18]

Chapter 1.10

1.10.5 In the heading row, add a reference "(c)" to a footnote after "Tank (l)". The footnote reads as follows:

"(c) A value indicated in this column is applicable only if carriage in tanks is authorized, in accordance with Chapter 3.2, Table A, column (10) or (12). For substances that are not authorized for carriage in tanks, the instruction in this column is not relevant."

In the heading row, add a reference "(d)" to a footnote after "Bulk (kg)". The footnote reads as follows:

"(d) A value indicated in this column is applicable only if carriage in bulk is authorized, in accordance with Chapter 3.2, Table A, column (10) or (17). For substances that are not authorized for carriage in bulk, the instruction in this column is not relevant."

[Ref. doc.: ECE/TRANS/WP.15/AC.1/2007/50 as amended]

In the Table, add a new fourth line for Class 1 to read as follows:

Class	Division	Substance or article	Quantity		
			Tank (l) ^(c)	Bulk (kg) ^(d)	Packages (kg)
	1.4	Explosives of UN Nos. 0104, 0237, 0255, 0267, 0289, 0361, 0365, 0366, 0440, 0441, 0455, 0456 and 0500	(a)	(a)	0

In the Table, for Class 3, in the entry for "Desensitized explosives", in the fourth column (Tank (l)), replace "a" with:

"0".

[Ref. doc.: ECE/TRANS/WP.15/AC.1/2007/50 as amended]

In the Table, amend the second entry for Class 5.1 to read as follows:

Class	Division	Substance or article	Quantity		
			Tank (l) ^(c)	Bulk (kg) ^(d)	Packages (kg) ^(b)
		Perchlorates, ammonium nitrate, ammonium nitrate fertilisers and ammonium nitrate emulsions or suspensions or gels	3000	3000	

PART 2

Chapter 2.1

Add a new paragraph 2.1.3.5.5 as follows:

"2.1.3.5.5 If the substance to be carried is a waste, with a composition that is not precisely known, its assignment to a UN number and packing group in accordance with 2.1.3.5.2 may be based on the consignor's knowledge of the waste, including all available technical and safety data as requested by safety and environmental legislation in force*.

In case of doubt, the highest danger level shall be taken.

If however, on the basis of the knowledge of the composition of the waste and the physical and chemical properties of the identified components, it is possible to demonstrate that the properties of the waste do not correspond to the properties of the packing group I level, the waste may be classified by default in the most appropriate n.o.s. entry of packing group II.

This procedure may not be used for wastes containing substances mentioned in 2.1.3.5.3, substances of Class 4.3, substances of the case mentioned in 2.1.3.7 or substances which are not accepted for carriage in accordance with 2.2.x.2."

* Such legislation is for instance the Commission Decision 2000/532/EC of 3 May 2000 replacing Decision 94/3/EC establishing a list of wastes pursuant to Article 1(a) of Council Directive 75/442/EEC on waste (replaced by the Directive of the European Parliament and of the Council 2006/12/EC (Official Journal of the European Communities No. L 114 of 27 April 2006, page 9) and Council Decision 94/904/EC establishing a list of hazardous wastes pursuant to Article 1(4) of Council Directive 91/689/EEC on hazardous wastes (Official Journal of the European Communities No. L 226 of 6 September 2000, page 3)."

[Ref. doc.: INF.21 JM 03/07]

2.1.3.8 Amend to read as follows:

"Substances of classes 1 to 9, other than those assigned to UN Nos. 3077 or 3082, meeting the criteria of 2.2.9.1.10 are additionally to their hazards of classes 1 to 9 considered to be environmentally hazardous substances. Other substances meeting the criteria of 2.2.9.1.10 are to be assigned to UN Nos. 3077 or 3082 as appropriate."

[Ref. doc.: ECE/TRANS/WP.15/AC.1/2007/51 Annex 1, as amended]

Chapter 2.2

Section 2.2.1

2.2.1.1.7.5 In the Table, against "Shell, spherical or cylindrical" / "Preloaded mortar, shell in mortar", insert new third entry as follows:

Type	Includes: / Synonym:	Definition	Specification	Classification
			Colour shell: > 25% flash composition as loose powder and/or report effects	1.1 G

Amend Note 2 to read as follows:

"2: "Flash composition" in this Table refers to pyrotechnic compositions in powder form or as pyrotechnic units as presented in the fireworks, that are used to produce an aural effect, or used as a bursting charge or lifting charge, unless the time taken for the pressure rise is demonstrated to be more than 8 ms for 0.5 g of pyrotechnic composition in Test Series 2 (c) (i) "Time/pressure test" of the Manual of Tests and Criteria."

2.2.1.1.8 For "SIGNALS, DISTRESS, ship", add at the end:

", 0505, 0506".

For "SIGNALS, SMOKE", add at the end:

", 0507".

[Consequential amendment]

Section 2.2.2

2.2.2.3 For Classification code "6F", add the following new entries:

"3478 FUEL CELL CARTRIDGES, containing liquefied flammable gas or

3478 FUEL CELL CARTRIDGES CONTAINED IN EQUIPMENT, containing liquefied flammable gas or

3478 FUEL CELL CARTRIDGES PACKED WITH EQUIPMENT, containing liquefied flammable gas

3479 FUEL CELL CARTRIDGES, containing hydrogen in metal hydride or

3479 FUEL CELL CARTRIDGES CONTAINED IN EQUIPMENT, containing hydrogen in metal hydride or

3479 FUEL CELL CARTRIDGES PACKED WITH EQUIPMENT, containing hydrogen in metal hydride".

[Consequential amendment]

Section 2.2.3

- 2.2.3.1.5** At the beginning, replace "and non-corrosive" with:
"non-corrosive and non-environmentally hazardous".

Section 2.2.41

- 2.2.41.1.18** Replace "and 3380" with:
", 3380 and 3474".
- 2.2.41.3** Under "Solid desensitized explosive", classification code D, for UN 3344, insert after "PENTAERYTHRITE TETRANITRATE":
"(PENTAERYTHRITOL TETRANITRATE, PETN)".
[Consequential amendment]

Section 2.2.42

- 2.2.42.1.5** In Note 3, replace "2.3.6" with:
"2.3.5".
[Ref. doc.: ECE/TRANS/WP.15/AC.1/2007/51 Annex 1]

Section 2.2.43

- 2.2.43.1.5** In the Note, replace "2.3.6" with:
"2.3.5".
[Ref. doc.: ECE/TRANS/WP.15/AC.1/2007/51 Annex 1]
- 2.2.43.2** Delete "solids, flammable, assigned to UN No. 3132, water-reactive" and "and water-reactive solids, self-heating, assigned to UN No. 3135".
[Ref. doc.: TRANS/WP.15/AC.1/2006/29]
- 2.2.43.3** Under "WF2" for UN No. 3132, delete:
"(not allowed, see 2.2.43.2)".
[Ref. doc.: TRANS/WP.15/AC.1/2006/29]
- Under "WS" for UN No. 3135, delete:
"(not allowed, see 2.2.43.2)".
[Ref. doc.: TRANS/WP.15/AC.1/2006/29]

Section 2.2.52

2.2.52.4 In the Table, amend the entries listed below as follows:

Organic peroxide		Column	Amendment
tert-AMYLPEROXY-3,5,5-TRIMETHYLHEXANOATE		Packing method	Replace "OP5" with: "OP7".
		Number	Replace "3101" with: "3105"
DICUMYL PEROXIDE (<i>Concentration > 52-100</i>)	(1 st row)	Inert solid	Delete: " ≤ 57 ".
DI-(2-ETHYLHEXYL) PEROXYDICARBONATE (<i>Concentration ≤ 62 as a stable dispersion in water</i>)	(3 rd row)	Number	Replace "3117" with: "3119".
DI-(2-ETHYLHEXYL) PEROXYDICARBONATE (<i>Concentration ≤ 52 as a stable dispersion in water</i>)	(4 th row)	Delete.	

In the Table, insert the following new entries:

Organic peroxide	(2)	(3)	(4)	(5)	(6)	(7)	(8)	(9)
tert-AMYL PEROXYNEO-DECANOATE	≤ 47	≥ 53					3119	prohibited
tert-BUTYL PEROXY 3,5,5-TRIMETHYLHEXANOATE	≤ 42			≥ 58		OP7	3106	
CUMYL PEROXYNEO-DECANOATE	≤ 87	≥ 13					3115	prohibited
2,2-DI-(tert-AMYLPEROXY)-BUTANE	≤ 57	≥ 43				OP7	3105	
1,1-DI-(tert-BUTYL-PEROXY)-CYCLOHEXANE	≤ 72		≥ 28			OP5	3103	(30)
1,1-DI-(tert-BUTYL-PEROXY)-CYCLOHEXANE + tert-BUTYL PEROXY-2-ETHYLHEXANOATE	$\leq 43 + \leq 16$	≥ 41				OP7	3105	
1,1-DI-(tert-BUTYL-PEROXY)-3,3,5-TRIMETHYLCYCLOHEXANE	≤ 90		≥ 10			OP5	3103	(30)
DI-2,4-DICHLOROBENZOYL PEROXIDE	≤ 52 as a paste						3118	prohibited
3-HYDROXY-1,1-DIMETHYLBUTYL PEROXYNEODECANOATE	≤ 77	≥ 23					3115	prohibited
3-HYDROXY-1,1-DIMETHYLBUTYL PEROXYNEODECANOATE	≤ 52 as a stable dispersion in water						3119	prohibited
3-HYDROXY-1,1-DIMETHYLBUTYL PEROXYNEODECANOATE	≤ 52	≥ 48					3117	prohibited
METHYL ISOPROPYL KETONE PEROXIDE(S)	See remark 31)	≥ 70				OP8	3109	(31)
3,3,5,7,7-PENTAMETHYL-1,2,4-TRIOXEPANE	≤ 100					OP8	3107	

After the Table, add the following new notes:

"(30) Diluent type B with boiling point > 130 °C.

(31) Active oxygen ≤ 6.7%."

Section 2.2.62

2.2.62.1.5.6 Renumber existing Note as Note 1.

In Note 1 (existing Note) after "antibody detection in humans or animals", add:

"in the absence of any concern for infection (e.g. evaluation of vaccine induced immunity, diagnosis of autoimmune disease, etc.)".

Add a new Note 2 to read as follows:

"2: For air transport, packagings for specimens exempted under this paragraph shall meet the conditions in (a) to (c)."

2.2.62.1.11.2 Add at the end, before the notes:

"For the assignment, international, regional or national waste catalogues may be taken into account."

2.2.62.1.12.2 Amend to read as follows:

"2.2.62.1.12.2 Animal material affected by pathogens of Category A or by pathogens which would be assigned to Category A in cultures only, shall be assigned to UN 2814 or UN 2900 as appropriate. Animal material affected by pathogens of Category B, other than those which would be assigned to Category A if they were in cultures, shall be assigned to UN 3373."

Section 2.2.7

Amend 2.2.7 to read as follows:

[Consequential amendments see under 1.6.6.1, 1.6.6.2.1, 1.6.6.2.2, 3.2.1 column (5), 4.1.9.1.1, 4.1.9.2.3 (b) und (c), 5.2.2.1.11.2 (a) (i), 6.4.8.8, 6.4.10.3, 6.4.12.1, 6.4.12.2 and 6.4.14]

"2.2.7 **Class 7: Radioactive material**

2.2.7.1 **Definitions**

2.2.7.1.1 **Radioactive material** means any material containing radionuclides where both the activity concentration and the total activity in the consignment exceed the values specified in 2.2.7.2.2.1 to 2.2.7.2.2.6.

2.2.7.1.2 **Contamination**

Contamination means the presence of a radioactive substance on a surface in quantities in excess of 0.4 Bq/cm² for beta and gamma emitters and low toxicity alpha emitters, or 0.04 Bq/cm² for all other alpha emitters.

Non-fixed contamination means contamination that can be removed from a surface during routine conditions of carriage.

Fixed contamination means contamination other than non-fixed contamination.

2.2.7.1.3 **Definitions of specific terms**

A₁ and A₂

A₁ means the activity value of special form radioactive material which is listed in the Table in 2.2.7.2.2.1 or derived in 2.2.7.2.2.2 and is used to determine the activity limits for the requirements of RID.

A₂ means the activity value of radioactive material, other than special form radioactive material, which is listed in the Table in 2.2.7.2.2.1 or derived in 2.2.7.2.2.2 and is used to determine the activity limits for the requirements of RID.

Fissile material means uranium-233, uranium-235, plutonium-239, plutonium-241, or any combination of these radionuclides. Excepted from this definition is:

- (a) Natural uranium or depleted uranium which is unirradiated; and
- (b) Natural uranium or depleted uranium which has been irradiated in thermal reactors only.

Low dispersible radioactive material means either a solid radioactive material or a solid radioactive material in a sealed capsule, that has limited dispersibility and is not in powder form.

Low specific activity (LSA) material means radioactive material which by its nature has a limited specific activity, or radioactive material for which limits of estimated average specific activity apply. External shielding materials surrounding the LSA material shall not be considered in determining the estimated average specific activity.

Low toxicity alpha emitters are: natural uranium; depleted uranium; natural thorium; uranium-235 or uranium-238; thorium-232; thorium-228 and thorium-230 when contained in ores or physical and chemical concentrates; or alpha emitters with a half-life of less than 10 days.

Specific activity of a radionuclide means the activity per unit mass of that nuclide. The specific activity of a material shall mean the activity per unit mass of the material in which the radionuclides are essentially uniformly distributed.

Special form radioactive material means either:

- (a) An indispersible solid radioactive material; or
- (b) A sealed capsule containing radioactive material.

Surface contaminated object (SCO) means a solid object which is not itself radioactive but which has radioactive material distributed on its surfaces.

Unirradiated thorium means thorium containing not more than 10^{-7} g of uranium-233 per gram of thorium-232.

Unirradiated uranium means uranium containing not more than 2×10^3 Bq of plutonium per gram of uranium-235, not more than 9×10^6 Bq of fission products per gram of uranium-235 and not more than 5×10^{-3} g of uranium-236 per gram of uranium-235.

Uranium – natural, depleted, enriched means the following:

Natural uranium means uranium (which may be chemically separated) containing the naturally occurring distribution of uranium isotopes (approximately 99.28% uranium-238, and 0.72% uranium-235 by mass).

Depleted uranium means uranium containing a lesser mass percentage of uranium-235 than in natural uranium.

Enriched uranium means uranium containing a greater mass percentage of uranium-235 than 0.72%.

In all cases, a very small mass percentage of uranium-234 is present.

2.2.7.2 Classification

2.2.7.2.1 General provisions

2.2.7.2.1.1 Radioactive material shall be assigned to one of the UN number specified in Table 2.2.7.2.1.1 depending on the activity level of the radionuclides contained in a package, the fissile or non-fissile properties of these radionuclides, the type of package to be presented for carriage, and the nature or form of the contents of the package, or special arrangements governing the carriage operation, in accordance with the provisions laid down in 2.2.7.2.2 to 2.2.7.2.5.

Table 2.2.7.2.1.1: Assignment of UN numbers

Excepted packages (1.7.1.5)	
UN 2908	RADIOACTIVE MATERIAL, EXCEPTED PACKAGE – EMPTY PACKAGING
UN 2909	RADIOACTIVE MATERIAL, EXCEPTED PACKAGE – ARTICLES MANUFACTURED FROM NATURAL URANIUM or DEPLETED URANIUM or NATURAL THORIUM
UN 2910	RADIOACTIVE MATERIAL, EXCEPTED PACKAGE – LIMITED QUANTITY OF MATERIAL
UN 2911	RADIOACTIVE MATERIAL, EXCEPTED PACKAGE – INSTRUMENTS or ARTICLES
Low specific activity radioactive material (2.2.7.2.3.1)	
UN 2912	RADIOACTIVE MATERIAL, LOW SPECIFIC ACTIVITY (LSA-I), non-fissile or fissile-excepted
UN 3321	RADIOACTIVE MATERIAL, LOW SPECIFIC ACTIVITY (LSA-II), non fissile or fissile-excepted
UN 3322	RADIOACTIVE MATERIAL, LOW SPECIFIC ACTIVITY (LSA-III), non fissile or fissile-excepted
UN 3324	RADIOACTIVE MATERIAL, LOW SPECIFIC ACTIVITY (LSA-II), FISSILE
UN 3325	RADIOACTIVE MATERIAL, LOW SPECIFIC ACTIVITY, (LSA-III), FISSILE
Surface contaminated objects (2.2.7.2.3.2)	
UN 2913	RADIOACTIVE MATERIAL, SURFACE CONTAMINATED OBJECTS (SCO-I or SCO-II), non-fissile or fissile-excepted
UN 3326	RADIOACTIVE MATERIAL, SURFACE CONTAMINATED OBJECTS (SCO-I or SCO-II), FISSILE

Type A packages (2.2.7.2.4.4)	
UN 2915	RADIOACTIVE MATERIAL, TYPE A PACKAGE, non-special form, non-fissile or fissile-excepted
UN 3327	RADIOACTIVE MATERIAL, TYPE A PACKAGE, FISSILE, non-special form
UN 3332	RADIOACTIVE MATERIAL, TYPE A PACKAGE, SPECIAL FORM, non fissile or fissile-excepted
UN 3333	RADIOACTIVE MATERIAL, TYPE A PACKAGE, SPECIAL FORM, FISSILE
Type B(U) packages (2.2.7.2.4.6)	
UN 2916	RADIOACTIVE MATERIAL, TYPE B(U) PACKAGE, non-fissile or fissile-excepted
UN 3328	RADIOACTIVE MATERIAL, TYPE B(U) PACKAGE, FISSILE
Type B(M) packages (2.2.7.2.4.6)	
UN 2917	RADIOACTIVE MATERIAL, TYPE B(M) PACKAGE, non-fissile or fissile-excepted
UN 3329	RADIOACTIVE MATERIAL, TYPE B(M) PACKAGE, FISSILE
Type C packages (2.2.7.2.4.6)	
UN 3323	RADIOACTIVE MATERIAL, TYPE C PACKAGE, non fissile or fissile-excepted
UN 3330	RADIOACTIVE MATERIAL, TYPE C PACKAGE, FISSILE
Special arrangement (2.2.7.2.5)	
UN 2919	RADIOACTIVE MATERIAL, TRANSPORTED UNDER SPECIAL ARRANGEMENT, non-fissile or fissile-excepted
UN 3331	RADIOACTIVE MATERIAL, TRANSPORTED UNDER SPECIAL ARRANGEMENT, FISSILE
Uranium hexafluoride (2.2.7.2.4.5)	
UN 2977	RADIOACTIVE MATERIAL, URANIUM HEXAFLUORIDE, FISSILE
UN 2978	RADIOACTIVE MATERIAL, URANIUM HEXAFLUORIDE, non-fissile or fissile-excepted

2.2.7.2.2 Determination of activity level

2.2.7.2.2.1 The following basic values for individual radionuclides are given in Table 2.2.7.2.2.1:

- (a) A_1 and A_2 in TBq;
- (b) Activity concentration for exempt material in Bq/g; and
- (c) Activity limits for exempt consignments in Bq.

Table 2.2.7.2.2.1: Basic radionuclides values for individual radionuclides

[Insert here the Table of existing 2.2.7.7.2.1 with its footnotes (a) – (g)]

2.2.7.2.2.2 For individual radionuclides which are not listed in Table 2.2.7.2.2.1 the determination of the basic radionuclide values referred to in 2.2.7.2.2.1 shall require multilateral approval. It is permissible to use an A_2 value calculated using a dose coefficient for the appropriate lung absorption type as recommended by the International Commission on Radiological Protection, if the chemical forms of each radionuclide under both normal and accident conditions of carriage are taken into consideration. Alternatively, the radionuclide values in Table 2.2.7.2.2.2 may be used without obtaining competent authority approval.

Table 2.2.7.2.2.2: Basic radionuclide values for unknown radionuclides or mixtures

Radioactive contents	A ₁	A ₂	Activity concentration for exempt material	Activity limit for exempt consignments
	(TBq)	(TBq)	(Bq/g)	(Bq)
Only beta or gamma emitting nuclides are known to be present	0.1	0.02	1 x 10 ¹	1 x 10 ⁴
Alpha emitting nuclides but no neutron emitters are known to be present	0.2	9 x 10 ⁻⁵	1 x 10 ⁻¹	1 x 10 ³
Neutron emitting nuclides are known to be present or no relevant data are available	0.001	9 x 10 ⁻⁵	1 x 10 ⁻¹	1 x 10 ³

2.2.7.2.2.3 In the calculations of A₁ and A₂ for a radionuclide not in Table 2.2.7.2.2.1, a single radioactive decay chain in which the radionuclides are present in their naturally occurring proportions, and in which no daughter nuclide has a half-life either longer than 10 days or longer than that of the parent nuclide, shall be considered as a single radionuclide; and the activity to be taken into account and the A₁ or A₂ value to be applied shall be those corresponding to the parent nuclide of that chain. In the case of radioactive decay chains in which any daughter nuclide has a half-life either longer than 10 days or greater than that of the parent nuclide, the parent and such daughter nuclides shall be considered as mixtures of different nuclides.

2.2.7.2.2.4 For mixtures of radionuclides, the determination of the basic radionuclide values referred to in 2.2.7.2.2.1 may be determined as follows:

$$X_m = \frac{1}{\sum_i \frac{f(i)}{X(i)}}$$

where

f (i) is the fraction of activity or activity concentration of radionuclide i in the mixture;

X (i) is the appropriate value of A₁ or A₂, or the activity concentration for exempt material or the activity limit for an exempt consignment as appropriate for the radionuclide i; and

X_m is the derived value of A₁ or A₂, or the activity concentration for exempt material or the activity limit for an exempt consignment in the case of a mixture.

2.2.7.2.2.5 When the identity of each radionuclide is known but the individual activities of some of the radionuclides are not known, the radionuclides may be grouped and the lowest radionuclide value, as appropriate, for the radionuclides in each group may be used in applying the formulas in 2.2.7.2.2.4 and 2.2.7.2.4.4. Groups may be based on the total alpha activity and the total beta/gamma activity when these are known, using the lowest radionuclide values for the alpha emitters or beta/gamma emitters, respectively.

2.2.7.2.2.6 For individual radionuclides or for mixtures of radionuclides for which relevant data are not available, the values shown in Table 2.2.7.2.2.2 shall be used.

2.2.7.2.3 Determination of other material characteristics

2.2.7.2.3.1 Low specific activity (LSA) material

2.2.7.2.3.1.1 (Reserved)

2.2.7.2.3.1.2 LSA material shall be in one of three groups:

(a) LSA-I

- (i) uranium and thorium ores and concentrates of such ores, and other ores containing naturally occurring radionuclides which are intended to be processed for the use of these radionuclides;
- (ii) natural uranium, depleted uranium, natural thorium or their compounds or mixtures, providing they are unirradiated and in solid or liquid form;
- (iii) radioactive material for which the A_2 value is unlimited, excluding material classified as fissile according to 2.2.7.2.3.5; or
- (iv) other radioactive material in which the activity is distributed throughout and the estimated average specific activity does not exceed 30 times the values for activity concentration specified in 2.2.7.2.2.1 to 2.2.7.2.2.6, excluding material classified as fissile according to 2.2.7.2.3.5;

(b) LSA-II

- (i) water with tritium concentration up to 0.8 TBq/l; or
- (ii) other material in which the activity is distributed throughout and the estimated average specific activity does not exceed $10^{-4} A_2/g$ for solids and gases, and $10^{-5} A_2/g$ for liquids;

(c) LSA-III – Solids (e.g. consolidated wastes, activated materials), excluding powders, in which:

- (i) the radioactive material is distributed throughout a solid or a collection of solid objects, or is essentially uniformly distributed in a solid compact binding agent (such as concrete, bitumen, ceramic, etc.);
- (ii) the radioactive material is relatively insoluble, or it is intrinsically contained in a relatively insoluble matrix, so that, even under loss of packaging, the loss of radioactive material per package by leaching when placed in water for seven days would not exceed $0.1 A_2$; and
- (iii) the estimated average specific activity of the solid, excluding any shielding material, does not exceed $2 \times 10^{-3} A_2/g$.

2.2.7.2.3.1.3 LSA-III material shall be a solid of such a nature that if the entire contents of a package were subjected to the test specified in 2.2.7.2.3.1.4 the activity in the water would not exceed $0.1 A_2$.

2.2.7.2.3.1.4 LSA-III material shall be tested as follows:

A solid material sample representing the entire contents of the package shall be immersed for 7 days in water at ambient temperature. The volume of water to be used in the test shall be sufficient to ensure that at the end of the 7 day test period the free volume of the unabsorbed and unreacted water remaining shall be at least 10% of the volume of the solid test sample itself. The water shall have an initial pH of 6-8 and a maximum conductivity of 1 mS/m at 20 °C. The total activity of the free volume of water shall be measured following the 7 day immersion of the test sample.

2.2.7.2.3.1.5 Demonstration of compliance with the performance standards in 2.2.7.2.3.1.4 shall be in accordance with 6.4.12.1 and 6.4.12.2.

2.2.7.2.3.2 Surface contaminated object (SCO)

SCO is classified in one of two groups:

(a) SCO-I: A solid object on which:

- (i) the non-fixed contamination on the accessible surface averaged over 300 cm² (or the area of the surface if less than 300 cm²) does not exceed 4 Bq/cm² for beta and gamma emitters and low toxicity alpha emitters, or 0.4 Bq/cm² for all other alpha emitters; and
- (ii) the fixed contamination on the accessible surface averaged over 300 cm² (or the area of the surface if less than 300 cm²) does not exceed 4×10^4 Bq/cm² for beta and gamma emitters and low toxicity alpha emitters, or 4×10^3 Bq/cm² for all other alpha emitters; and
- (iii) the non-fixed contamination plus the fixed contamination on the inaccessible surface averaged over 300 cm² (or the area of the surface if less than 300 cm²) does not exceed 4×10^4 Bq/cm² for beta and gamma emitters and low toxicity alpha emitters, or 4×10^3 Bq/cm² for all other alpha emitters;

(b) SCO-II: A solid object on which either the fixed or non-fixed contamination on the surface exceeds the applicable limits specified for SCO-I in (a) above and on which:

- (i) the non-fixed contamination on the accessible surface averaged over 300 cm² (or the area of the surface if less than 300 cm²) does not exceed 400 Bq/cm² for beta and gamma emitters and low toxicity alpha emitters, or 40 Bq/cm² for all other alpha emitters; and
- (ii) the fixed contamination on the accessible surface, averaged over 300 cm² (or the area of the surface if less than 300 cm²) does not exceed 8×10^5 Bq/cm² for beta and gamma emitters and low toxicity alpha emitters, or 8×10^4 Bq/cm² for all other alpha emitters; and
- (iii) the non-fixed contamination plus the fixed contamination on the inaccessible surface averaged over 300 cm² (or the area of the surface if less than 300 cm²) does not exceed 8×10^5 Bq/cm² for beta and gamma emitters and low toxicity alpha emitters, or 8×10^4 Bq/cm² for all other alpha emitters.

2.2.7.2.3.3 Special form radioactive material

- 2.2.7.2.3.3.1** Special form radioactive material shall have at least one dimension not less than 5 mm. When a sealed capsule constitutes part of the special form radioactive material, the capsule shall be so manufactured that it can be opened only by destroying it. The design for special form radioactive material requires unilateral approval.
- 2.2.7.2.3.3.2** Special form radioactive material shall be of such a nature or shall be so designed that if it is subjected to the tests specified in 2.2.7.2.3.3.4 to 2.2.7.2.3.3.8, it shall meet the following requirements:
- (a) It would not break or shatter under the impact, percussion and bending tests 2.2.7.2.3.3.5 (a), (b), (c) or 2.2.7.2.3.3.6 (a) as applicable;
 - (b) It would not melt or disperse in the applicable heat test 2.2.7.2.3.3.5 (d) or 2.2.7.2.3.3.6 (b) as applicable; and
 - (c) The activity in the water from the leaching tests specified in 2.2.7.2.3.3.7 and 2.2.7.2.3.3.8 would not exceed 2 kBq; or alternatively for sealed sources, the leakage rate for the volumetric leakage assessment test specified in ISO 9978:1992 "Radiation Protection – Sealed Radioactive Sources – Leakage Test Methods", would not exceed the applicable acceptance threshold acceptable to the competent authority.
- 2.2.7.2.3.3.3** Demonstration of compliance with the performance standards in 2.2.7.2.3.3.2 shall be in accordance with 6.4.12.1 and 6.4.12.2.
- 2.2.7.2.3.3.4** Specimens that comprise or simulate special form radioactive material shall be subjected to the impact test, the percussion test, the bending test, and the heat test specified in 2.2.7.2.3.3.5 or alternative tests as authorized in 2.2.7.2.3.3.6. A different specimen may be used for each of the tests. Following each test, a leaching assessment or volumetric leakage test shall be performed on the specimen by a method no less sensitive than the methods given in 2.2.7.2.3.3.7 for indispersible solid material or 2.2.7.2.3.3.8 for encapsulated material.
- 2.2.7.2.3.3.5** The relevant test methods are:
- (a) Impact test: The specimen shall drop onto the target from a height of 9 m. The target shall be as defined in 6.4.14;
 - (b) Percussion test: The specimen shall be placed on a sheet of lead which is supported by a smooth solid surface and struck by the flat face of a mild steel bar so as to cause an impact equivalent to that resulting from a free drop of 1.4 kg through 1 m. The lower part of the bar shall be 25 mm in diameter with the edges rounded off to a radius of (3.0 ± 0.3) mm. The lead, of hardness number 3.5 to 4.5 on the Vickers scale and not more than 25 mm thick, shall cover an area greater than that covered by the specimen. A fresh surface of lead shall be used for each impact. The bar shall strike the specimen so as to cause maximum damage;
 - (c) Bending test: The test shall apply only to long, slender sources with both a minimum length of 10 cm and a length to minimum width ratio of not less than 10. The specimen shall be rigidly clamped in a horizontal position so that one half of its length protrudes from the face of the clamp. The orientation of the specimen shall be such that the specimen will suffer maximum damage when its free end is struck by the flat face of a steel bar. The bar shall strike the specimen so as to cause an impact equivalent to that resulting from a free vertical

drop of 1.4 kg through 1 m. The lower part of the bar shall be 25 mm in diameter with the edges rounded off to a radius of (3.0 ± 0.3) mm;

- (d) Heat test: The specimen shall be heated in air to a temperature of 800 °C and held at that temperature for a period of 10 minutes and shall then be allowed to cool.

2.2.7.2.3.3.6 Specimens that comprise or simulate radioactive material enclosed in a sealed capsule may be excepted from:

- (a) The tests prescribed in 2.2.7.2.3.3.5 (a) and (b) provided the mass of the special form radioactive material:
 - (i) is less than 200 g and they are alternatively subjected to the Class 4 impact test prescribed in ISO 2919:1999 "Radiation protection – Sealed radioactive sources – General requirements and classification"; or
 - (ii) is less than 500 g and they are alternatively subjected to the Class 5 impact test prescribed in ISO 2919:1999 "Radiation protection – Sealed radioactive sources – General requirements and classification"; and
- (b) The test prescribed in 2.2.7.2.3.3.5 (d) provided they are alternatively subjected to the Class 6 temperature test specified in ISO 2919:1999 "Radiation protection – Sealed radioactive sources – General requirements and classification".

2.2.7.2.3.3.7 For specimens which comprise or simulate indispersible solid material, a leaching assessment shall be performed as follows:

- (a) The specimen shall be immersed for 7 days in water at ambient temperature. The volume of water to be used in the test shall be sufficient to ensure that at the end of the 7 day test period the free volume of the unabsorbed and unreacted water remaining shall be at least 10% of the volume of the solid test sample itself. The water shall have an initial pH of 6-8 and a maximum conductivity of 1 mS/m at 20 °C;
- (b) The water with specimen shall then be heated to a temperature of (50 ± 5) °C and maintained at this temperature for 4 hours;
- (c) The activity of the water shall then be determined;
- (d) The specimen shall then be kept for at least 7 days in still air at not less than 30 °C and relative humidity not less than 90%;
- (e) The specimen shall then be immersed in water of the same specification as in (a) above and the water with the specimen heated to (50 ± 5) °C and maintained at this temperature for 4 hours;
- (f) The activity of the water shall then be determined.

2.2.7.2.3.3.8 For specimens which comprise or simulate radioactive material enclosed in a sealed capsule, either a leaching assessment or a volumetric leakage assessment shall be performed as follows:

- (a) The leaching assessment shall consist of the following steps:
 - (i) the specimen shall be immersed in water at ambient temperature. The water shall have an initial pH of 6-8 with a maximum conductivity of 1 mS/m at 20 °C;
 - (ii) the water and specimen shall be heated to a temperature of (50 ± 5) °C and maintained at this temperature for 4 hours;
 - (iii) the activity of the water shall then be determined;
 - (iv) the specimen shall then be kept for at least 7 days in still air at not less than 30 °C and relative humidity of not less than 90%;
 - (v) the process in (i), (ii) and (iii) shall be repeated;
- (b) The alternative volumetric leakage assessment shall comprise any of the tests prescribed in ISO 9978:1992 "Radiation Protection – Sealed radioactive sources – Leakage test methods", which are acceptable to the competent authority.

2.2.7.2.3.4 Low dispersible material

2.2.7.2.3.4.1 The design for low dispersible radioactive material shall require multilateral approval. Low dispersible radioactive material shall be such that the total amount of this radioactive material in a package shall meet the following requirements:

- (a) The radiation level at 3 m from the unshielded radioactive material does not exceed 10 mSv/h;
- (b) If subjected to the tests specified in 6.4.20.3 and 6.4.20.4, the airborne release in gaseous and particulate forms of up to 100 µm aerodynamic equivalent diameter would not exceed 100 A₂. A separate specimen may be used for each test; and
- (c) If subjected to the test specified in 2.2.7.2.3.1.4 the activity in the water would not exceed 100 A₂. In the application of this test, the damaging effects of the tests specified in (b) above shall be taken into account.

2.2.7.2.3.4.2 Low dispersible material shall be tested as follows:

A specimen that comprises or simulates low dispersible radioactive material shall be subjected to the enhanced thermal test specified in 6.4.20.3 and the impact test specified in 6.4.20.4. A different specimen may be used for each of the tests. Following each test, the specimen shall be subjected to the leach test specified in 2.2.7.2.3.1.4. After each test it shall be determined if the applicable requirements of 2.2.7.2.3.4.1 have been met.

2.2.7.2.3.4.3 Demonstration of compliance with the performance standards in 2.2.7.2.3.4.1 and 2.2.7.2.3.4.2 shall be in accordance with 6.4.12.1 and 6.4.12.2.

2.2.7.2.3.5 Fissile material

Packages containing fissile radionuclides shall be classified under the relevant entry of Table 2.2.7.2.1.1 for fissile material unless one of the conditions (a) to (d) of this paragraph is met. Only one type of exception is allowed per consignment.

(a) A mass limit per consignment such that:

$$\frac{\text{mass of uranium - 235 (g)}}{X} + \frac{\text{mass of other fissile material (g)}}{Y} < 1$$

where X and Y are the mass limits defined in Table 2.2.7.2.3.5, provided that the smallest external dimension of each package is not less than 10 cm and that either:

- (i) each individual package contains not more than 15 g of fissile material; for unpackaged material, this quantity limitation shall apply to the consignment being carried in or on the wagon; or
- (ii) the fissile material is a homogeneous hydrogenous solution or mixture where the ratio of fissile nuclides to hydrogen is less than 5% by mass; or
- (iii) there are not more than 5 g of fissile material in any 10 litre volume of material.

Neither beryllium nor deuterium shall be present in quantities exceeding 1% of the applicable consignment mass limits provided in Table 2.2.7.2.3.5, except for deuterium in natural concentration in hydrogen.

- (b) Uranium enriched in uranium-235 to a maximum of 1% by mass, and with a total plutonium and uranium-233 content not exceeding 1% of the mass of uranium-235, provided that the fissile material is distributed essentially homogeneously throughout the material. In addition, if uranium-235 is present in metallic, oxide or carbide forms, it shall not form a lattice arrangement;
- (c) Liquid solutions of uranyl nitrate enriched in uranium-235 to a maximum of 2% by mass, with a total plutonium and uranium-233 content not exceeding 0.002% of the mass of uranium, and with a minimum nitrogen to uranium atomic ratio (N/U) of 2;
- (d) Packages containing, individually, a total plutonium mass not more than 1 kg, of which not more than 20% by mass may consist of plutonium-239, plutonium-241 or any combination of those radionuclides.

Table 2.2.7.2.3.5: Consignment mass limits for exceptions from the requirements for packages containing fissile material

Fissile material	Fissile material mass (g) mixed with substances having an average hydrogen density less than or equal to water	Fissile material mass (g) mixed with substances having an average hydrogen density greater than water
Uranium-235 (X)	400	290
Other fissile material (Y)	250	180

2.2.7.2.4 Classification of packages or unpacked material

The quantity of radioactive material in a package shall not exceed the relevant limits for the package type as specified below.

2.2.7.2.4.1 Classification as excepted package

2.2.7.2.4.1.1 Packages may be classified as excepted packages if:

- (a) They are empty packagings having contained radioactive material;
- (b) They contain instruments or articles in limited quantities;
- (c) They contain articles manufactured of natural uranium, depleted uranium or natural thorium; or
- (d) They contain radioactive material in limited quantities.

2.2.7.2.4.1.2 A package containing radioactive material may be classified as an excepted package provided that the radiation level at any point on its external surface does not exceed 5 µSv/h.

Table 2.2.7.2.4.1.2: Activity limits for excepted packages

Physical state of contents	Instruments or articles		Materials Package limits ^(a)
	Item limits ^(a)	Package limits ^(a)	
(1)	(2)	(3)	(4)
Solids			
special form	$10^{-2} A_1$	A_1	$10^{-3} A_1$
other form	$10^{-2} A_2$	A_2	$10^{-3} A_2$
Liquids	$10^{-3} A_2$	$10^{-1} A_2$	$10^{-4} A_2$
Gases			
tritium	$2 \times 10^{-2} A_2$	$2 \times 10^{-1} A_2$	$2 \times 10^{-2} A_2$
special form	$10^{-3} A_1$	$10^{-2} A_1$	$10^{-3} A_1$
other form	$10^{-3} A_2$	$10^{-2} A_2$	$10^{-3} A_2$

^(a) For mixtures of radionuclides, see 2.2.7.2.2.4 to 2.2.7.2.2.6.

2.2.7.2.4.1.3 Radioactive material which is enclosed in or is included as a component part of an instrument or other manufactured article may be classified under UN No. 2911 RADIOACTIVE MATERIAL, EXCEPTED PACKAGE – INSTRUMENTS or ARTICLES provided that:

- (a) The radiation level at 10 cm from any point on the external surface of any un-packaged instrument or article is not greater than 0.1 mSv/h; and
- (b) Each instrument or manufactured article bears the marking "RADIOACTIVE" except:
 - (i) radioluminescent time-pieces or devices;
 - (ii) consumer products that either have received regulatory approval according to 1.7.1.4 (d) or do not individually exceed the activity limit for an exempt consignment in Table 2.2.7.2.2.1 (column 5), provided such products are carried in a package that bears the marking "RADIOACTIVE" on an internal surface in such a manner that warning of the presence of radioactive material is visible on opening the package; and
- (c) The active material is completely enclosed by non-active components (a device performing the sole function of containing radioactive material shall not be considered to be an instrument or manufactured article); and

- (d) The limits specified in columns 2 and 3 of Table 2.2.7.2.4.1.2 are met for each individual item and each package, respectively.

2.2.7.2.4.1.4 Radioactive material with an activity not exceeding the limit specified in column 4 of Table 2.2.7.2.4.1.2, may be classified under UN No. 2910 RADIOACTIVE MATERIAL, EXCEPTED PACKAGE – LIMITED QUANTITY OF MATERIAL provided that:

- (a) The package retains its radioactive contents under routine conditions of carriage; and
- (b) The package bears the marking "RADIOACTIVE" on an internal surface in such a manner that a warning of the presence of radioactive material is visible on opening the package.

2.2.7.2.4.1.5 An empty packaging which had previously contained radioactive material with an activity not exceeding the limit specified in column 4 of Table 2.2.7.2.4.1.2 may be classified under UN No. 2908 RADIOACTIVE MATERIAL, EXCEPTED PACKAGE – EMPTY PACKAGING, provided that:

- (a) It is in a well-maintained condition and securely closed;
- (b) The outer surface of any uranium or thorium in its structure is covered with an inactive sheath made of metal or some other substantial material;
- (c) The level of internal non-fixed contamination, when averaged over any 300 cm², does not exceed:
 - (i) 400 Bq/cm² for beta and gamma emitters and low toxicity alpha emitters; and
 - (ii) 40 Bq/cm² for all other alpha emitters; and
- (d) Any labels which may have been displayed on it in conformity with 5.2.2.1.11.1 are no longer visible.

2.2.7.2.4.1.6 Articles manufactured of natural uranium, depleted uranium or natural thorium and articles in which the sole radioactive material is unirradiated natural uranium, unirradiated depleted uranium or unirradiated natural thorium may be classified under UN No. 2909 RADIOACTIVE MATERIAL, EXCEPTED PACKAGE – ARTICLES MANUFACTURED FROM NATURAL URANIUM or DEPLETED URANIUM or NATURAL THORIUM, provided that the outer surface of the uranium or thorium is enclosed in an inactive sheath made of metal or some other substantial material.

2.2.7.2.4.2 Classification as Low specific activity (LSA) material

Radioactive material may only be classified as LSA material if the conditions of 2.2.7.2.3.1 and 4.1.9.2 are met.

2.2.7.2.4.3 Classification as Surface contaminated object (SCO)

Radioactive material may be classified as SCO if the conditions of 2.2.7.2.3.2.1 and 4.1.9.2 are met.

2.2.7.2.4.4 Classification as Type A package

Packages containing radioactive material may be classified as Type A packages provided that the following conditions are met:

Type A packages shall not contain activities greater than the following:

- (a) For special form radioactive material: A_1 ; or
- (b) For all other radioactive material: A_2 .

For mixtures of radionuclides whose identities and respective activities are known, the following condition shall apply to the radioactive contents of a Type A package:

$$\sum_i \frac{B(i)}{A_1(i)} + \sum_j \frac{C(j)}{A_2(j)} \leq 1$$

where

$B(i)$ is the activity of radionuclide i as special form radioactive material;

$A_1(i)$ is the A_1 value for radionuclide i ;

$C(j)$ is the activity of radionuclide j as other than special form radioactive material;
and

$A_2(j)$ is the A_2 value for radionuclide j .

2.2.7.2.4.5 Classification of Uranium hexafluoride

Uranium hexafluoride shall only be assigned to UN Nos. 2977 RADIOACTIVE MATERIAL, URANIUM HEXAFLUORIDE, FISSIONABLE, or 2978 RADIOACTIVE MATERIAL, URANIUM HEXAFLUORIDE, non-fissionable or fissionable-excepted.

2.2.7.2.4.5.1 Packages containing uranium hexafluoride shall not contain:

- (a) A mass of uranium hexafluoride different from that authorized for the package design;
- (b) A mass of uranium hexafluoride greater than a value that would lead to an ullage smaller than 5% at the maximum temperature of the package as specified for the plant systems where the package shall be used; or
- (c) Uranium hexafluoride other than in solid form or at an internal pressure above atmospheric pressure when presented for carriage.

2.2.7.2.4.6 Classification as Type B(U), Type B(M) or Type C packages

2.2.7.2.4.6.1 Packages not otherwise classified in 2.2.7.2.4 (2.2.7.2.4.1 to 2.2.7.2.4.5) shall be classified in accordance with the competent authority approval certificate for the package issued by the country of origin of design.

2.2.7.2.4.6.2 A package may only be classified as a Type B(U) if it does not contain:

- (a) Activities greater than those authorized for the package design;
- (b) Radionuclides different from those authorized for the package design; or
- (c) Contents in a form, or a physical or chemical state different from those authorized for the package design;

as specified in the certificate of approval.

2.2.7.2.4.6.3 A package may only be classified as a Type B(M) if it does not contain:

- (a) Activities greater than those authorized for the package design;
- (b) Radionuclides different from those authorized for the package design; or
- (c) Contents in a form, or a physical or chemical state different from those authorized for the package design;

as specified in the certificate of approval.

2.2.7.2.4.6.4 A package may only be classified as a Type C if it does not contain:

- (a) Activities greater than those authorized for the package design;
- (b) Radionuclides different from those authorized for the package design; or
- (c) Contents in a form, or physical or chemical state different from those authorized for the package design;

as specified in the certificate of approval.

2.2.7.2.5 Special arrangements

Radioactive material shall be classified as transported under special arrangement when it is intended to be carried in accordance with 1.7.4."

Section 2.2.8

2.2.8.1.6 c) In the first sentence of the second indent, replace "corrosion rate on steel" with:

"corrosion rate on either steel".

At the end of the first sentence of the second indent, insert:

"when tested on both materials".

Add a new note at the end to read as follows:

"NOTE: Where an initial test on either steel or aluminium indicates the substance being tested is corrosive the follow up test on the other metal is not required."

Section 2.2.9

2.2.9.1.7 Insert the following new first sentence:

"The term "lithium battery" covers all cells and batteries containing lithium in any form."

At the beginning of the second sentence (current first sentence), replace "Lithium cells and batteries" with:

"They".

2.2.9.1.9 Amend to read as follows:

"2.2.9.1.9 (Reserved)".

2.2.9.1.10 Amend to read as follows:

"2.2.9.1.10 Environmentally hazardous substances (aquatic environment)

2.2.9.1.10.1 General definitions

2.2.9.1.10.1.1 Environmentally hazardous substances include, inter alia, liquid or solid substances pollutant to the aquatic environment and solutions and mixtures of such substances (such as preparations and wastes).

For the purposes of 2.2.9.1.10,

"*Substance*" means chemical elements and their compounds in the natural state or obtained by any production process, including any additive necessary to preserve the stability of the product and any impurities deriving from the process used, but excluding any solvent which may be separated without affecting the stability of the substance or changing its composition.

2.2.9.1.10.1.2 The aquatic environment may be considered in terms of the aquatic organisms that live in the water, and the aquatic ecosystem of which they are part¹. The basis, therefore, of the identification of hazard is the aquatic toxicity of the substance or mixture, although this may be modified by further information on the degradation and bioaccumulation behaviour.

2.2.9.1.10.1.3 While the following classification procedure is intended to apply to all substances and mixtures, it is recognised that in some cases, e.g. metals or poorly soluble inorganic compounds, special guidance will be necessary².

2.2.9.1.10.1.4 The following definitions apply for acronyms or terms used in this section:

- BCF: Bioconcentration Factor;
- BOD: Biochemical Oxygen Demand;
- COD: Chemical Oxygen Demand;
- GLP: Good Laboratory Practices;
- EC₅₀: the effective concentration of substance that causes 50% of the maximum response;
- ErC₅₀: EC₅₀ in terms of reduction of growth;
- K_{ow}: octanol/water partition coefficient;
- LC₅₀ (50% lethal concentration):
the concentration of a substance in water which causes the death of 50% (one half) in a group of test animals;
- L(E)C₅₀: LC₅₀ or EC₅₀;
- NOEC: No Observed Effect Concentration;

¹ This does not address aquatic pollutants for which there may be a need to consider effects beyond the aquatic environment such as the impacts on human health etc.

² This can be found in Annex 10 of the GHS.

- OECD Test Guidelines: Test guidelines published by the Organization for Economic Cooperation and Development (OECD).

2.2.9.1.10.2 Definitions and data requirements

2.2.9.1.10.2.1 The basic elements for classification of environmentally hazardous substances (aquatic environment) are:

- acute aquatic toxicity;
- potential for or actual bioaccumulation;
- degradation (biotic or abiotic) for organic chemicals; and
- chronic aquatic toxicity.

2.2.9.1.10.2.2 While data from internationally harmonised test methods are preferred, in practice, data from national methods may also be used where they are considered as equivalent. In general, freshwater and marine species toxicity data can be considered as equivalent data and are preferably to be derived using OECD Test Guidelines or equivalent according to the principles of Good Laboratory Practices (GLP). Where such data are not available, classification shall be based on the best available data.

2.2.9.1.10.2.3 **Acute aquatic toxicity** shall normally be determined using a fish 96 hour LC₅₀ (OECD Test Guideline 203 or equivalent), a crustacea species 48 hour EC₅₀ (OECD Test Guideline 202 or equivalent) and/or an algal species 72 or 96 hour EC₅₀ (OECD Test Guideline 201 or equivalent). These species are considered as surrogates for all aquatic organisms. Data on other species such as Lemna may also be considered if the test methodology is suitable.

2.2.9.1.10.2.4 **Bioaccumulation** means net result of uptake, transformation and elimination of a substance in an organism due to all routes of exposure (i.e. air, water, sediment/soil and food).

The potential for bioaccumulation shall normally be determined by using the octanol/water partition coefficient, usually reported as a log K_{ow} determined according to OECD Test Guideline 107 or 117. While this represents a potential to bioaccumulate, an experimentally determined Bioconcentration Factor (BCF) provides a better measure and shall be used in preference when available. A BCF shall be determined according to OECD Test Guideline 305.

2.2.9.1.10.2.5 **Environmental degradation** may be biotic or abiotic (eg. hydrolysis) and the criteria used reflect this fact. Ready biodegradation is most easily defined using the OECD biodegradability tests (OECD Test Guideline 301 (A – F)). A pass level in these tests may be considered as indicative of rapid degradation in most aquatic environments. As these are freshwater tests, use of results from OECD Test Guideline 306, which is more suitable for the marine environment, is also included. Where such data are not available, a BOD (5 days)/COD ratio ≥ 0.5 is considered as indicative of rapid degradation. Abiotic degradation such as hydrolysis, primary degradation, both abiotic and biotic, degradation in non-aquatic media and proven rapid degradation in the environment may all be considered in defining rapid degradability³.

Substances are considered rapidly degradable in the environment if the following criteria are met:

³ Special guidance on data interpretation is provided in Chapter 3.10 and Annex 8 of the GHS.

(a) In 28-day ready biodegradation studies, the following levels of degradation are achieved:

(i) Tests based on dissolved organic carbon: 70%;

(ii) Tests based on oxygen depletion or carbon dioxide generation: 60% of theoretical maxima;

These levels of biodegradation shall be achieved within 10 days of the start of degradation which point is taken as the time when 10% of the substance has been degraded; or

(b) In those cases where only BOD and COD data are available, when the ratio of BOD₅/COD is ≥ 0.5 ; or

(c) If other convincing scientific evidence is available to demonstrate that the substance or mixture can be degraded (biotically and/or abiotically) in the aquatic environment to a level above 70% within a 28 day period.

2.2.9.1.10.2.6 **Chronic toxicity** data are less available than acute data and the range of testing procedures less standardised. Data generated according to the OECD Test Guidelines 210 (Fish Early Life Stage) or 211 (Daphnia Reproduction) and 201 (Algal Growth Inhibition) may be accepted. Other validated and internationally accepted tests may also be used. The "No Observed Effect Concentrations" (NOECs) or other equivalent L(E)Cx shall be used.

2.2.9.1.10.3 **Substance classification categories and criteria**

Substances shall be classified as "environmentally hazardous substances (aquatic environment)", if they satisfy the criteria for Acute 1, Chronic 1 or Chronic 2, according to the following Tables:

Acute toxicity

Category: Acute 1	
Acute toxicity:	
96 hr LC ₅₀ (for fish)	≤ 1 mg/l and/or
48 hr EC ₅₀ (for crustacea)	≤ 1 mg/l and/or
72 or 96hr ErC ₅₀ (for algae or other aquatic plants)	≤ 1 mg/l

Chronic toxicity

Category: Chronic 1	
Acute toxicity:	
96 hr LC ₅₀ (for fish)	≤ 1 mg/l and/or
48 hr EC ₅₀ (for crustacea)	≤ 1 mg/l and/or
72 or 96hr ErC ₅₀ (for algae or other aquatic plants)	≤ 1 mg/l
and the substance is not rapidly degradable and/or the log K _{ow} ≥ 4 (unless the experimentally determined BCF < 500)	

Category: Chronic 2

Acute toxicity:

96 hr LC₅₀ (for fish) > 1 bis ≤ 10 mg/l and/or

48 hr EC₅₀ (for crustacea) > 1 bis ≤ 10 mg/l and/or

72 or 96hr ErC₅₀ (for algae or other aquatic plants) > 1 bis ≤ 10 mg/l

and the substance is not rapidly degradable and/or the log K_{ow} ≥ 4 (unless the experimentally determined BCF < 500), unless the chronic toxicity NOECs are > 1 mg/l

The classification flowchart below outlines the process to be followed:

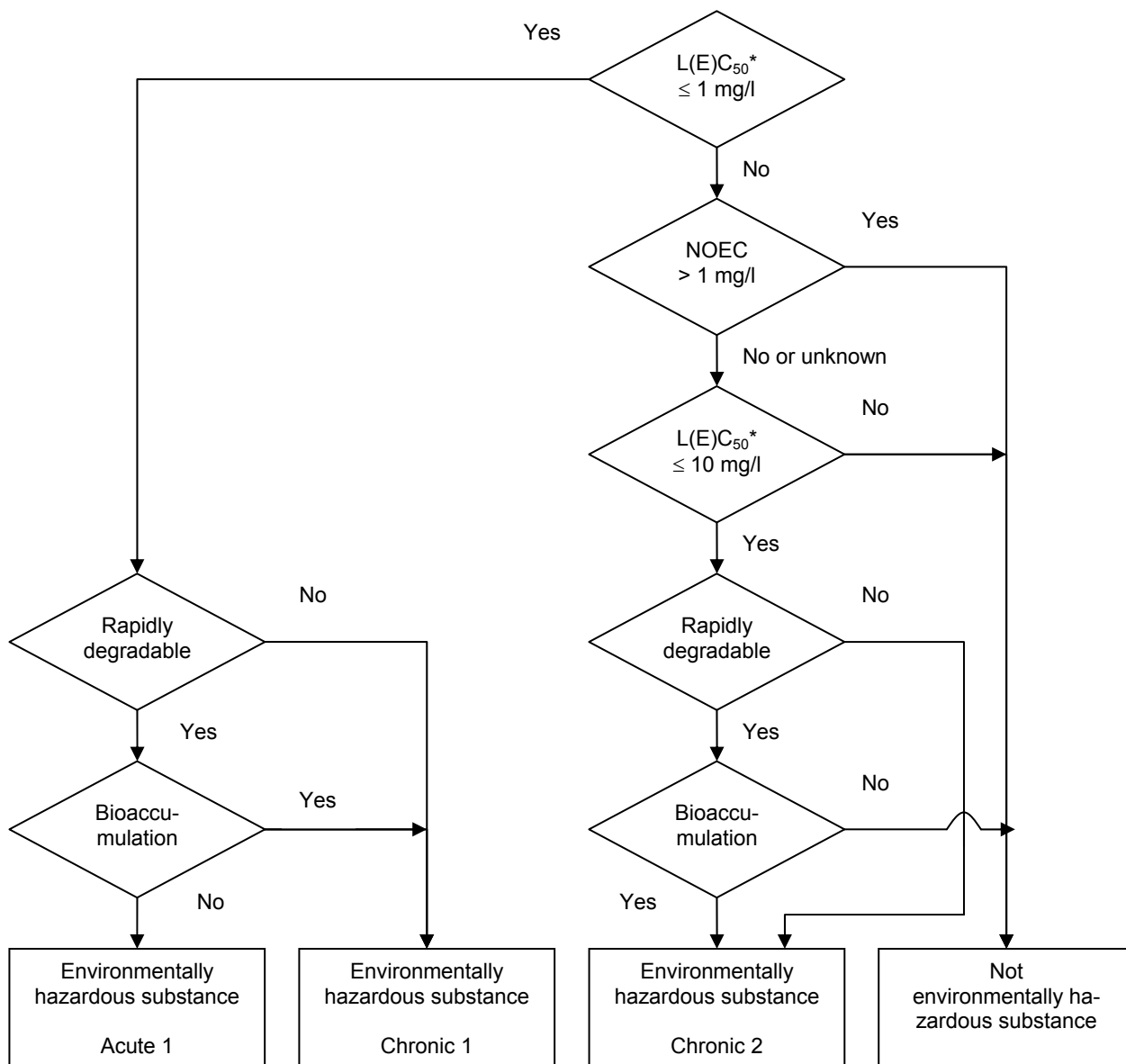

* Lowest value of 96-hour LC₅₀, 48-hour EC₅₀ or 72-hour or 96-hour ErC₅₀, as appropriate.

2.2.9.1.10.4 Mixtures classification categories and criteria

2.2.9.1.10.4.1 The classification system for mixtures covers the classification categories which are used for substances meaning acute category 1 and chronic categories 1 and 2. In order to make use of all available data for purposes of classifying the aquatic environmental hazards of the mixture, the following assumption is made and is applied where appropriate:

The "relevant ingredients" of a mixture are those which are present in a concentration of 1% (w/w) or greater, unless there is a presumption (e.g. in the case of highly toxic ingredients) that an ingredient present at less than 1% can still be relevant for classifying the mixture for aquatic environmental hazards.

2.2.9.1.10.4.2 The approach for classification of aquatic environmental hazards is tiered, and is dependent upon the type of information available for the mixture itself and for its ingredients. Elements of the tiered approach include:

- (a) Classification based on tested mixtures;
- (b) Classification based on bridging principles;
- (c) The use of "summation of classified ingredients" and /or an "additivity formula".

Figure 2.2.9.1.10.4.2 below outlines the process to be followed.

Figure 2.2.9.1.10.4.2: Tiered approach to classification of mixtures for acute and chronic aquatic environmental hazards

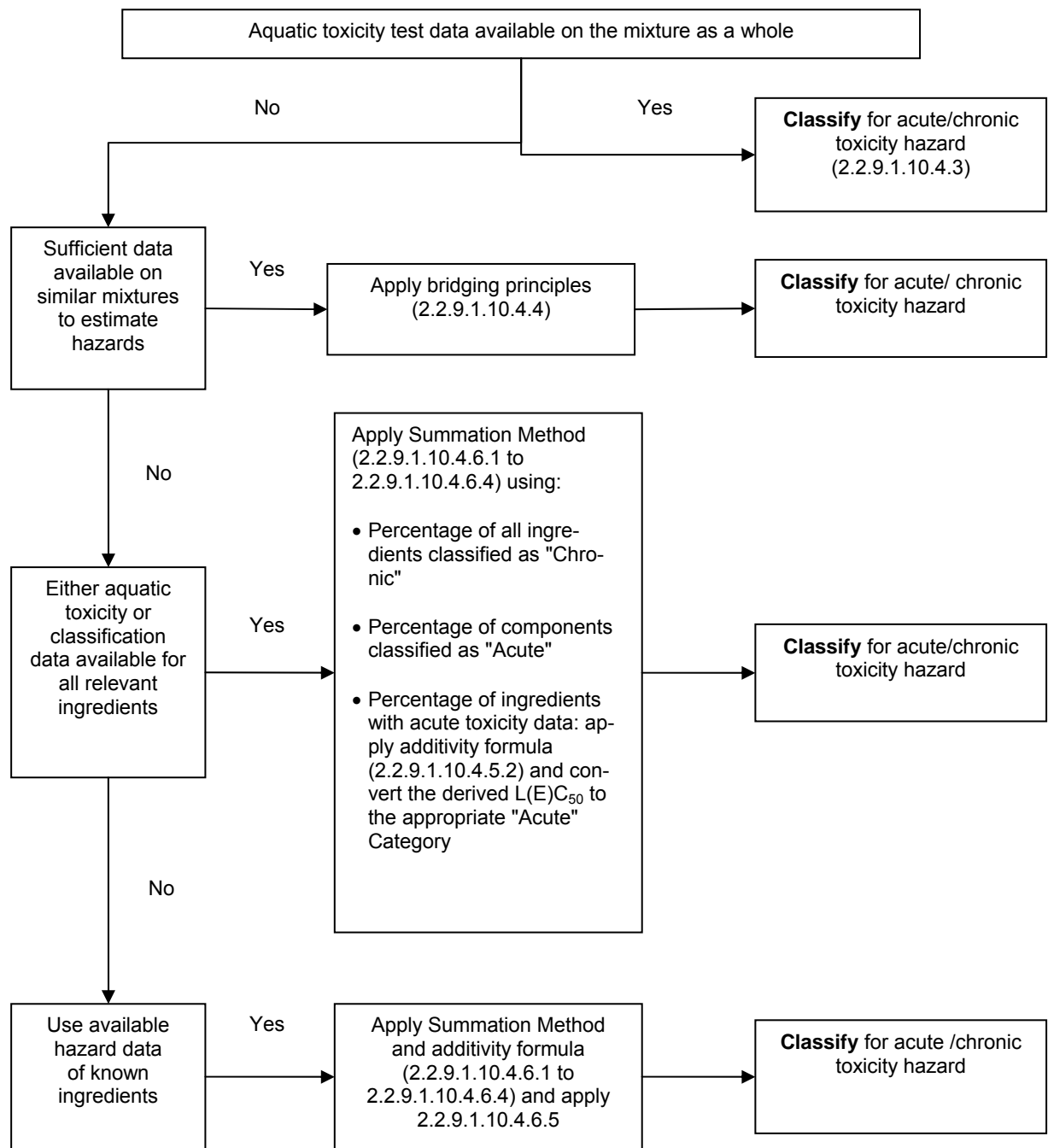

2.2.9.1.10.4.3 Classification of mixtures when data are available for the complete mixture

2.2.9.1.10.4.3.1 When the mixture as a whole has been tested to determine its aquatic toxicity, it shall be classified according to the criteria that have been agreed for substances, but only for acute toxicity. The classification is based on the data for fish, crustacea and algae/plants. Classification of mixtures by using LC₅₀ or EC₅₀ data for the mixture as a whole is not possible for chronic categories since both toxicity data and environmental fate data are needed, and there are no degradability and bioaccumulation data for mixtures as a whole. It is not possible to apply the criteria for chronic classification because the data from degradability and bioaccumulation tests of mixtures cannot be interpreted; they are meaningful only for single substances.

2.2.9.1.10.4.3.2 When there is acute toxicity test data (LC₅₀ or EC₅₀) available for the mixture as a whole, this data as well as information with respect to the classification of ingredients for chronic toxicity shall be used to complete the classification for tested mixtures as follows. When chronic (long term) toxicity data (NOEC) is also available, this shall be used in addition.

(a) L(E)C₅₀ (LC₅₀ or EC₅₀) of the tested mixture ≤ 1 mg/l and NOEC of the tested mixture ≤ 1.0 mg/l or unknown:

- classify mixture as category acute 1;
- apply summation of classified ingredients approach (see 2.2.9.1.10.4.6.3 and 2.2.9.1.10.4.6.4) for chronic classification (chronic 1, 2, or no need of chronic classification);

(b) L(E)C₅₀ of the tested mixture ≤ 1 mg/l and NOEC of the tested mixture > 1.0 mg/l:

- classify mixture as category acute 1;
- apply summation of classified ingredients approach (see 2.2.9.1.10.4.6.3 and 2.2.9.1.10.4.6.4) for classification as category chronic 1. If the mixture is not classified as category chronic 1, then there is no need for chronic classification;

(c) L(E)C₅₀ of the tested mixture > 1 mg/l, or above the water solubility, and NOEC of the tested mixture ≤ 1.0 mg/l or unknown:

- no need to classify for acute toxicity;
- apply summation of classified ingredients approach (see 2.2.9.1.10.4.6.3 and 2.2.9.1.10.4.6.4) for chronic classification or no need for chronic classification;

(d) L(E)C₅₀ of the tested mixture > 1 mg/l, or above the water solubility, and NOEC of the tested mixture > 1.0 mg/l:

- No need to classify for acute or chronic toxicity.

2.2.9.1.10.4.4 Bridging principles

2.2.9.1.10.4.4.1 Where the mixture itself has not been tested to determine its aquatic environmental hazard, but there are sufficient data on the individual ingredients and similar tested mixtures to adequately characterise the hazards of the mixture, this

data shall be used in accordance with the following agreed bridging rules. This ensures that the classification process uses the available data to the greatest extent possible in characterising the hazards of the mixture without the necessity for additional testing in animals.

2.2.9.1.10.4.4.2 Dilution

2.2.9.1.10.4.4.2.1 If a mixture is formed by diluting another classified mixture or a substance with a diluent which has an equivalent or lower aquatic hazard classification than the least toxic original ingredient and which is not expected to affect the aquatic hazards of other ingredients, then the mixture shall be classified as equivalent to the original mixture or substance.

2.2.9.1.10.4.4.2.2 If a mixture is formed by diluting another classified mixture or a substance with water or other totally non-toxic material, the toxicity of the mixture shall be calculated from the original mixture or substance.

2.2.9.1.10.4.4.3 Batching

The aquatic hazard classification of one production batch of a complex mixture shall be assumed to be substantially equivalent to that of another production batch of the same commercial product and produced by or under the control of the same manufacturer, unless there is reason to believe there is significant variation such that the aquatic hazard classification of the batch has changed. If the latter occurs, new classification is necessary.

2.2.9.1.10.4.4.4 Concentration of mixtures which are classified with the most severe classification categories (chronic 1 and acute 1)

If a mixture is classified as chronic 1 and/or acute 1, and ingredients of the mixture which are classified as chronic 1 and/or acute 1 are further concentrated, the more concentrated mixture shall be classified with the same classification category as the original mixture without additional testing.

2.2.9.1.10.4.4.5 Interpolation within one toxicity category

If mixtures A and B are in the same classification category and mixture C is made in which the toxicologically active ingredients have concentrations intermediate to those in mixtures A and B, then mixture C shall be in the same category as A and B. Note that the identity of the ingredients is the same in all three mixtures.

2.2.9.1.10.4.4.6 Substantially similar mixtures

Given the following:

(a) two mixtures:

- (i) A + B;
- (ii) C + B;

(b) the concentration of ingredient B is the same in both mixtures;

(c) the concentration of ingredient A in mixture (i) equals that of ingredient C in mixture (ii);

(d) classification for A and C are available and are the same, i.e. they are in the same hazard category and are not expected to affect the aquatic toxicity of

B,

then there shall be no need to test mixture (ii) if mixture (i) is already characterised by testing and both mixtures are classified in the same category.

2.2.9.1.10.4.5 Classification of mixtures when data are available for all ingredients or only for some ingredients of the mixture

2.2.9.1.10.4.5.1 The classification of a mixture shall be based on summation of the classification of its ingredients. The percentage of ingredients classified as "Acute" or "Chronic" will feed straight into the summation method. Details of the summation method are described in 2.2.9.1.10.4.6.1 to 2.2.9.1.10.4.6.4.

2.2.9.1.10.4.5.2 Mixtures are often made of a combination of both ingredients that are classified (as Acute 1 and/or Chronic 1, 2) and those for which adequate test data is available. When adequate toxicity data is available for more than one ingredient in the mixture, the combined toxicity of those ingredients shall be calculated using the following additivity formula, and the calculated toxicity shall be used to assign that portion of the mixture an acute toxicity hazard which is then subsequently used in applying the summation method.

$$\frac{\sum C_i}{L(E)C_{50m}} = \sum \frac{C_i}{L(E)C_{50i}}$$

where:

C_i = concentration of ingredient i (mass percentage);
 $L(E)C_{50i}$ = (mg/l) LC_{50} or EC_{50} for ingredient i;
 n = number of ingredients, and i is running from 1 to n;
 $L(E)C_{50m}$ = $L(E)C_{50}$ of the part of the mixture with test data.

2.2.9.1.10.4.5.3 When applying the additivity formula for part of the mixture, it is preferable to calculate the toxicity of this part of the mixture using for each substance toxicity values that relate to the same species (i.e. fish, daphnia or algae) and then to use the highest toxicity (lowest value) obtained (i.e. use the most sensitive of the three species). However, when toxicity data for each ingredient are not available in the same species, the toxicity value of each ingredient shall be selected in the same manner that toxicity values are selected for the classification of substances, i.e. the higher toxicity (from the most sensitive test organism) is used. The calculated acute toxicity shall then be used to classify this part of the mixture as Acute 1 using the same criteria described for substances.

2.2.9.1.10.4.5.4 If a mixture is classified in more than one way, the method yielding the more conservative result shall be used.

2.2.9.1.10.4.6 Summation method

2.2.9.1.10.4.6.1 Classification procedure

In general a more severe classification for mixtures overrides a less severe classification, e.g. a classification with chronic 1 overrides a classification with chronic 2. As a consequence the classification procedure is already completed if the result of the classification is chronic 1. A more severe classification than chronic 1 is not possible and it is not necessary therefore to undergo the further classification procedure.

2.2.9.1.10.4.6.2 Classification for the acute category 1

2.2.9.1.10.4.6.2.1 All ingredients classified as acute 1 shall be considered. If the sum of these ingredients is greater than 25% the whole mixture shall be classified as category acute 1. If the result of the calculation is a classification of the mixture as category acute 1, the classification process is completed.

2.2.9.1.10.4.6.2.2 The classification of mixtures for acute hazards based on this summation of classified ingredients, is summarised in Table 2.2.9.1.10.4.6.2.2 below.

Table 2.2.9.1.10.4.6.2.2: Classification of a mixture for acute hazards, based on summation of classified ingredients

Sum of ingredients classified as:	Mixture is classified as:
Acute 1 x M ^(a) > 25%	Acute 1

^(a) For explanation of the M factor, see 2.2.9.1.10.4.6.4.

2.2.9.1.10.4.6.3 Classification for the chronic categories 1, 2

2.2.9.1.10.4.6.3.1 First, all ingredients classified as chronic 1 are considered. If the sum of these ingredients is greater than 25% the mixture shall be classified as category chronic 1. If the result of the calculation is a classification of the mixture as category chronic 1 the classification procedure is completed.

2.2.9.1.10.4.6.3.2 In cases where the mixture is not classified as chronic 1, classification of the mixture as chronic 2 is considered. A mixture shall be classified as chronic 2 if 10 times the sum of all ingredients classified as chronic 1 plus the sum of all ingredients classified as chronic 2 is greater than 25%. If the result of the calculation is classification of the mixture as chronic 2, the classification process is completed.

2.2.9.1.10.4.6.3.3 The classification of mixtures for chronic hazards, based on this summation of classified ingredients, is summarised in Table 2.2.9.1.10.4.6.3.3 below.

Table 2.2.9.1.10.4.6.3.3: Classification of a mixture for chronic hazards, based on summation of classified ingredients

Sum of ingredients classified as:	Mixture is classified as:
Chronic 1 x M ^(a) > 25 %	Chronic 1
(M x 10 x Chronic 1) + Chronic 2 > 25 %	Chronic 2

^(a) For explanation of the M factor, see 2.2.9.1.10.4.6.4.

2.2.9.1.10.4.6.4 Mixtures with highly toxic ingredients

Acute category 1 ingredients with toxicities well below 1 mg/l may influence the toxicity of the mixture and are given increased weight in applying the summation of classification approach. When a mixture contains ingredients classified as acute or chronic category 1, the tiered approach described in 2.2.9.1.10.4.6.2 and 2.2.9.1.10.4.6.3 shall be applied using a weighted sum by multiplying the concentrations of acute category 1 ingredients by a factor, instead of merely adding up the percentages. This means that the concentration of "Acute 1" in the left column of Table 2.2.9.1.10.4.6.2 and the concentration of "Chronic 1" in the left column of Table 2.2.9.1.10.4.6.3.3 are multiplied by the appropriate multiplying factor. The multiplying factors to be applied to these ingredients are defined using the toxicity value, as summarised in Table 2.2.9.1.10.4.6.4 below. Therefore, in order to classify a mixture containing acute 1 and/or chronic 1 ingredients, the

classifier needs to be informed of the value of the M factor in order to apply the summation method. Alternatively, the additivity formula (see 2.2.9.1.10.4.5.2) may be used when toxicity data are available for all highly toxic ingredients in the mixture and there is convincing evidence that all other ingredients, including those for which specific acute toxicity data are not available, are of low or no toxicity and do not significantly contribute to the environmental hazard of the mixture.

Tabelle 2.2.9.1.10.4.6.4: Multiplying factors for highly toxic ingredients of mixtures

L(E)C₅₀ value	Multiplying factor (M)
$0.1 < L(E)C_{50} \leq 1$	1
$0.01 < L(E)C_{50} \leq 0.1$	10
$0.001 < L(E)C_{50} \leq 0.01$	100
$0.0001 < L(E)C_{50} \leq 0.001$	1000
$0.00001 < L(E)C_{50} \leq 0.0001$	10000
(continue in factor 10 intervals)	

2.2.9.1.10.4.6.5 Classification of mixtures with ingredients without any useable information

In the event that no useable information on acute and/or chronic aquatic hazard is available for one or more relevant ingredients, it is concluded that the mixture cannot be attributed (a) definitive hazard category(ies). In this situation the mixture shall be classified based on the known ingredients only with the additional statement that: "x percent of the mixture consists of ingredient(s) of unknown hazard to the aquatic environment".

2.2.9.1.10.5 **Substances or mixtures dangerous to the aquatic environment not otherwise classified under RID**

2.2.9.1.10.5.1 Substances or mixtures dangerous to the aquatic environment not otherwise classified under RID shall be designated:

UN No. 3077 ENVIRONMENTALLY HAZARDOUS SUBSTANCE, SOLID, N.O.S.
or
UN No. 3082 ENVIRONMENTALLY HAZARDOUS SUBSTANCE, LIQUID, N.O.S.

They shall be assigned to packing group III.

2.2.9.1.10.5.2 Notwithstanding the provisions of 2.2.9.1.10,

- (a) Substances which cannot be assigned to entries other than UN Nos. 3077 and 3082 in Class 9 or to other entries in classes 1 to 8, but which are identified in Council Directive 67/548/EEC of 27 June 1967 on the approximation of laws, regulations and administrative provisions relating to the classification, packaging and labelling of dangerous substances⁴, as amended, as substances to which letter N "Environmentally hazardous" (R50; R50/53; R51/53) has been allocated; and
- (b) Solutions and mixtures (such as preparations and wastes) of substances to which letter N "Environmentally hazardous" (R50; R50/53; R51/53) has been allocated in Directive 67/548/EEC, as amended, and which, according to Di-

⁴ Official Journal of the European Communities No.196, of 16 August 1967, pp. 1 – 5.

rective 1999/45/EC of the European Parliament and of the Council of 31 May 1999 concerning the approximation of the laws, regulations and administrative provisions of the Member States relating to the classification, packaging and labelling of dangerous preparations⁵, as amended, are also allocated letter N "Environmentally hazardous" (R50; R50/53; R51/53), and which cannot be assigned to entries other than UN Nos. 3077 and 3082 in Class 9 or to other entries in classes 1 to 8;

shall be assigned to UN Nos. 3077 or 3082 of Class 9 as appropriate."

[Ref. doc.: ECE/TRANS/WP.15/AC.1/2007/51 Annex 2 + INF.55 JM 09/07 + INF.58 JM 09/07 as amended]

2.2.9.1.15 Amend to read as follows:

"2.2.9.1.15 When indicated in column (4) of Table A of Chapter 3.2, substances and articles of Class 9 are assigned to one of the following packing groups according to their degree of danger:

Packing group II: substances presenting medium danger;
Packing group III: substances presenting low danger."

[Ref. doc.: ECE/TRANS/WP.15/AC.1/2006/7 + INF.36 JM 03/06]

2.2.9.3 Amend the entries under classification code M 4 to read as follows:

"3090 LITHIUM BATTERIES (including lithium alloy batteries)

3091 LITHIUM BATTERIES CONTAINED IN EQUIPMENT (including lithium alloy batteries) or

3091 LITHIUM BATTERIES PACKED WITH EQUIPMENT (including lithium alloy batteries)

3480 LITHIUM ION BATTERIES (including lithium ion polymer batteries)

3481 LITHIUM ION BATTERIES CONTAINED IN EQUIPMENT (including lithium ion polymer batteries) or

3481 LITHIUM ION BATTERIES PACKED WITH EQUIPMENT (including lithium ion polymer batteries)".

[Consequential amendment]

Chapter 2.3

2.3.5 Delete.

[Ref. doc.: ECE/TRANS/WP.15/AC.1/2007/51 Annex 1]

2.3.6 Renumber as **2.3.5**.

Replace "Figure 2.3.6" with:

"Figure 2.3.5" (twice).

[Ref. doc.: ECE/TRANS/WP.15/AC.1/2007/51 Annex 1]

⁵ Official Journal of the European Communities No. L 200, of 30 July 1999, pp. 1 – 68.

PART 3

Amend the heading to read as follows:

"Dangerous goods lists, special provisions and exemptions related to limited and excepted quantities".

Chapter 3.1

3.1.2.2 After examples (a) and (b), delete:

"each supplemented with the technical name of the goods (see 3.1.2.8.1)".

Chapter 3.2

3.2.1 In the third sub-paragraph of the explanatory note for **column (5)**, replace "2.2.7.8.4" with:

"5.1.5.3.4".

[Consequential amendment]

In the explanatory note for **column (7)**, replace "Column (7)" with:

"Column (7a)".

At the end of the second indent of the explanatory note for column (7a), delete the text between brackets.

After the explanatory note for column (7a), insert the following new explanatory note:

"Column (7b) "Excepted Quantities"

Contains an alphanumeric code with the following meaning:

- "E0" signifies that no exemption from the provisions of RID exists for the dangerous goods packed in excepted quantities;
- All the other alphanumerical codes starting with the letter "E" signify that the provisions of RID are not applicable if the conditions indicated in Chapter 3.5 are fulfilled."

In the explanatory notes for **column (8)**, delete the last indent.

[Ref. doc.: TRANS/WP.15/AC.1/2006/15 + TRANS/WP.15/AC.1/2006/30 + INF.35 JM 09/06 as amended]

Chapter 3.2
Table A

Add special provision "274" wherever special provision 61 is mentioned in **column (6)**, except for UN No. 3048.

[This modification concerns all packing groups for the following UN Nos.: 2588, 2757-2764, 2771, 2772, 2775-2784, 2786, 2787, 2902, 2903, 2991-2998, 3005, 3006, 3009-3021, 3024-3027, 3345-3352.

[Ref. doc.: ECE/TRANS/WP.15/AC.1/2007/4]

Renumber **column (7)** as (7a) and insert a new column (7b).

Insert a common heading for both columns (7a) and (7b) as follows:

" Limited and excepted quantities	
3.4.6 / 3.5.1.2	
(7a)	(7b)"

Add "E0" in column (7b) for:

- All goods of Class 1, except for UN Nos. 0020, 0021, 0074, 0113, 0114, 0129, 0130, 0135, 0224 and 0473;
- All goods of Class 5.2, except for UN Nos. 3111 to 3120;
- All goods of Class 6.2;
- All goods of Class 7;
- All goods of Class 2 for which only label 2.1 has been assigned in column (5);
- All goods of Class 2 for which label 2.3 (with or without other label) has been assigned in column (5);
- All goods of Class 2, for which labels "2.2+5.1" have been assigned in column (5) and UN Nos. 1044, 1950 (as far as not already taken into account under the fifth and sixth indent), 2037 (as far as not already taken into account under the fifth and sixth indent), 2857 and 3164;
- UN Nos. 1204, 2059 (4x), 3064, 3256, 3269 (3x), 3343, 3357, 3379 and 3473 in Class 3;
- All goods of Class 3, packing group I, for which labels "3+6.1", "3+8" or "3+6.1+8" have been assigned in column (5);
- All goods of Class 4.1, packing group I, and UN Nos. 2304, 2448, 2555, 2556, 2557, 2907, 3176 (packing groups II and III), 3221 to 3230, 3319 and 3344;
- All goods of Class 4.2, packing group I;
- All goods of Class 4.3, packing group I, and UN 3292;
- All goods of Class 5.1, packing group I, and UN Nos. 2426 and 3356;

- UN Nos. 1600, 1700, 2016, 2017, 2312 and 3250 of Class 6.1;
- All goods of Class 8, packing group I, and UN Nos. 1774, 2028, 2215 (MOLTEN), 2576, 2794, 2795, 2800, 2803, 2809 and 3028;
- UN Nos. 2990, 3072, 3090, 3091, 3245 (2x), 3257, 3258, 3268 and 3316 (2x) of Class 9.

Add "E1" in column (7b) for:

- All goods of Class 2, for which only label 2.2 has been assigned in column (5) except for those goods to which "E0" has already been assigned to and except for UN No.1043;
- All goods of Class 3, packing group III, for which only label 3 has been assigned in column (5), except for UN Nos. 2059, 3256 and 3269;
- All goods of Class 3, packing group III, for which labels "3+6.1" or "3+8" have been assigned in column (5);
- All goods of Class 4.1, packing group III, except for UN Nos. 2304, 2448 and 3176;
- All goods of Class 4.2, packing group III;
- All goods of Class 4.3, packing group III;
- All goods of Class 5.1, packing group III;
- All goods of Class 6.1, packing group III;
- All goods of Class 8, packing group III, except for UN Nos. 2215 (MOLTEN), 2803 and 2809;
- All goods of Class 9, packing group III, except for UN Nos. 3257, 3258 and 3268.

Add "E2" in column (7b) for:

- All goods of Class 3, packing group II, for which only label 3 has been assigned in column (5), except for UN Nos. 1204, 2059, 3064, 3269 and 3357;
- All goods of Class 3, packing group II, for which labels "3+6.1", "3+6.1+8" or "3+8" have been assigned in column (5);
- All goods of Class 4.1, packing group II, except for UN Nos. 2555, 2556, 2557, 2907, 3176, 3319 and 3344;
- All goods of Class 4.2, packing group II;
- All goods of Class 4.3, packing group II, except for UN 3292;
- All goods of Class 5.1, packing group II, except for UN 3356;
- All goods of Class 8, packing group II, except for UN Nos. 1774, 2028 and 2576;
- All goods of Class 9, packing group II, except for UN Nos. 3090, 3091 and 3316.

Add "E3" in column (7b) for:

- All goods of Class 3, packing group I, for which only label 3 has been assigned in column (5), except for UN Nos. 2059 and 3379.

Add "E4" in column (7b) for:

- All goods of Class 6.1, packing group II, except for UN Nos. 1600, 1700, 2016, 2017, 2312 and 3250.

Add "E5" in column (7b) for

- all goods of Class 6.1, packing group I.

Delete PR1 to PR7 wherever they appear in **column (8)**.

For the entries for which "LQ7" is listed in column (7), replace "MP15" with "MP19" each time it appears in **column (9b)**.

[Applicable to packing group III of the following UN Nos.:

1556, 1583, 1591, 1593, 1597, 1599, 1602, 1656, 1658, 1686, 1710, 1718, 1719, 1731, 1755, 1757, 1760, 1761, 1783, 1787, 1788, 1789, 1791, 1793, 1805, 1814, 1819, 1824, 1835, 1840, 1848, 1851, 1887, 1888, 1897, 1902, 1903, 1908, 1935, 1938, 2021, 2024, 2030, 2205, 2206, 2209, 2225, 2235, 2269, 2272, 2273, 2274, 2279, 2289, 2290, 2294, 2299, 2300, 2311, 2320, 2321, 2326, 2327, 2328, 2431, 2432, 2433, 2470, 2491, 2496, 2501, 2504, 2511, 2515, 2518, 2525, 2533, 2564, 2565, 2580, 2581, 2582, 2586, 2609, 2656, 2661, 2664, 2667, 2669, 2672, 2677, 2679, 2681, 2688, 2689, 2693, 2730, 2732, 2735, 2739, 2747, 2753, 2785, 2788, 2790, 2801, 2810, 2815, 2817, 2818, 2819, 2820, 2821, 2829, 2831, 2837, 2849, 2872, 2873, 2874, 2902, 2903, 2904, 2922, 2937, 2941, 2942, 2946, 2991, 2992, 2993, 2994, 2995, 2996, 2997, 2998, 3005, 3006, 3009, 3010, 3011, 3012, 3013, 3014, 3015, 3016, 3017, 3018, 3019, 3020, 3025, 3026, 3055, 3066, 3082, 3140, 3141, 3142, 3144, 3145, 3172, 3264, 3265, 3266, 3267, 3276, 3278, 3280, 3281, 3282, 3287, 3293, 3320, 3347, 3348, 3351, 3352, 3410, 3411, 3412, 3413, 3414, 3415, 3418, 3421, 3422, 3424, 3426, 3429, 3434, 3440, 3471 and 3472]

[Ref. doc.: 2006/13]

Delete "TP9" each time it appears in **column (11)** with the exception of UN 3375.

Delete "TP12" each time it appears in **column (11)**.

For all gases of Class 2 permitted for carriage in tanks, insert in **column (13)**:

"TA4 TT9".

[Ref. doc.: ECE/TRANS/WP.15/AC.1/2007/18]

Amend Table A as follows:

UN No.	Co-lumn	Amendment
0411	(2)	(does not apply to the English version)
1017	(3b)	Replace "2 TC" with: "2 TOC".
	(5)	After "2.3", insert: "+5.1".
	(20)	Replace "268" with: "265".
		[Consequential amendments see under 4.1.4.1 P 200 Table 2 and 4.3.3.2.5]
1052	(13)	Insert: "TA4 TT9". [Ref. doc.: ECE/TRANS/WP.15/AC.1/2007/18] Delete: "TM5". [Ref. doc.: INF.8 JM 03/07 + INF.49 JM 03/07]
1057	(6)	Add: "654". [Ref. doc.: INF.21 JM 03/07]
1092	(10)	Replace "T14" with: "T22".
	(11)	Add: "TP35".
1098	(10)	Replace "T14" with: "T20".
	(11)	Add: "T35".
1143	(10)	Replace "T14" with: "T20".
	11	Add: "T35".
1162	8	Replace "P001 IBC02" with: "P010".
	(10)	Replace "T7" with: "T10".
	11	Add: "TP7".
1163	(10)	Replace "T14" with: "T20".
	(11)	Add: "T35".
1170	(6)	Delete: "330" (twice).
1183	(9a)	Add: "RR7". [Ref. doc.: TRANS/WP.15/AC.1/2006/15 + TRANS/WP.15/AC.1/2006/30 + INF.35 JM 09/06 as amended]
	(10)	Replace "T10" with: "T14".
1185	(10)	Insert: "T22".
	(11)	Insert: "TP2".

UN No.	Co-lumn	Amendment
1196	(8)	Replace "P001 IBC02" with: "P010".
	(10)	Replace "T7" with: "T10".
	(11)	Add: "TP7".
1204	(6)	Insert: "601". [Ref. doc.: ECE/TRANS/WP.15/AC.1/2007/57]
1238	(10)	Replace "T14" with: "T22".
	(11)	Add: "TP35".
1239	(10)	Replace "T14" with: "T22".
	(11)	Add: "TP35".
1242	(9a)	Add: "RR7". [Ref. doc.: TRANS/WP.15/AC.1/2006/15 + TRANS/WP.15/AC.1/2006/30 + INF.35 JM 09/06 as amended]
	(10)	Replace "T10" with: "T14".
1244	(10)	Replace "T14" with: "T22".
	(11)	Add: "TP35".
1250	(4)	Replace "I" with: "II".
	(7a)	Replace "LQ3" with: "LQ4".
	(8)	Replace "P001" with: "P010".
	(9b)	Replace "MP7 MP17" with: "MP19".
	(10)	Replace "T11" with: "T10".
	(11)	Add: "TP7".
	(14)	Replace "1" with: "2".
	(19)	Add: "CE7".
1251	(9a)	Add: "RR7". [Ref. doc.: TRANS/WP.15/AC.1/2006/15 + TRANS/WP.15/AC.1/2006/30 + INF.35 JM 09/06 as amended]
1295	(9a)	Add: "RR7". [Ref. doc.: TRANS/WP.15/AC.1/2006/15 + TRANS/WP.15/AC.1/2006/30 + INF.35 JM 09/06 as amended]
1298	(8)	Replace "P001 IBC02" with: "P010".
	(10)	Replace "T7" with:

UN No.	Co-lumn	Amendment
		"T10".
	(11)	Add: "TP7".
1305	(4)	Replace "I" with: "II".
	(7a)	Replace "LQ3" with: "LQ4".
	(8)	Replace "P001" with: "P010".
	(9b)	Replace "MP7 MP17" with: "MP19".
	(10)	Replace "T11" with: "T10".
	(11)	Add: "TP7".
	(14)	Replace "1" with: "2".
	(19)	Add: "CE7".
1344	(2)	After "TRINITROPHENOL" insert: "(PICRIC ACID)".
1389	(9a)	Add: "RR8". [Ref. doc.: TRANS/WP.15/AC.1/2006/15 + TRANS/WP.15/AC.1/2006/30 + INF.35 JM 09/06 as amended]
1391	(9a)	Add: "RR8". [Ref. doc.: TRANS/WP.15/AC.1/2006/15 + TRANS/WP.15/AC.1/2006/30 + INF.35 JM 09/06 as amended]
1411	(9a)	Add: "RR8". [Ref. doc.: TRANS/WP.15/AC.1/2006/15 + TRANS/WP.15/AC.1/2006/30 + INF.35 JM 09/06 as amended]
1421	(9a)	Add: "RR8". [Ref. doc.: TRANS/WP.15/AC.1/2006/15 + TRANS/WP.15/AC.1/2006/30 + INF.35 JM 09/06 as amended]
1473	(16)	Insert: "W11".
1474	(6)	Insert: "332".
1484	(16)	Insert: "W11".
1485	(16)	Insert: "W11".
1487	(16)	Insert: "W11".
1488	(16)	Insert: "W11".
1490	(16)	Insert: "W11".
1493	(16)	Insert: "W11".
1494	(16)	Insert:

UN No.	Co-lumn	Amendment
		"W11".
1495	(16)	Insert: "W11".
1512	(16)	Insert: "W11".
1514	(16)	Insert: "W11".
1569	(10)	Replace "T3" with: "T20".
	(11)	Replace "TP33" with: "TP2".
1595	(10)	Replace "T14" with: "T20".
	(11)	Add: "T35".
1614	(9a)	Replace "RR3" with: "RR10". [Ref. doc.: TRANS/WP.15/AC.1/2006/15 + TRANS/WP.15/AC.1/2006/30 + INF.35 JM 09/06 as amended]
1647	(10)	Insert: "T20".
	(11)	Insert: "TP2".
1695	(10)	Replace "T14" with: "T20".
	(11)	Add: "T35".
1724	(8)	Replace "P001 IBC02" with: "P010".
	(10)	Replace "T7" with: "T10".
	(11)	Add: "TP7".
1728	(8)	Replace "P001 IBC02" with: "P010".
	(10)	Replace "T7" with: "T10".
	(11)	Add: "TP7".
1744	(8)	Replace "P601" with: "P804".
	(9a)	Delete: "PP82".
1747	(8)	Replace "P001 IBC02" with: "P010".
	(10)	Replace "T7" with: "T10".
	(11)	Add: "TP7".
1751	(16)	Insert: "W11".
1752	(10)	Replace "T14" with: "T20".
	(11)	Add:

UN No.	Co-lumn	Amendment
		"T35".
1753	(8)	Replace "P001 IBC02" with: "P010".
	(10)	Replace "T7" with: "T10".
	(11)	Add: "TP7".
1762	(8)	Replace "P001 IBC02" with: "P010".
	(10)	Replace "T7" with: "T10".
	(11)	Add: "TP7".
1763	(8)	Replace "P001 IBC02" with: "P010".
	(10)	Replace "T7" with: "T10".
	(11)	Add: "TP7".
1766	(8)	Replace "P001 IBC02" with: "P010".
	(10)	Replace "T7" with: "T10".
	(11)	Add: "TP7".
1767	(8)	Replace "P001 IBC02" with: "P010".
	(10)	Replace "T7" with: "T10".
	(11)	Add: "TP7".
1769	(8)	Replace "P001 IBC02" with: "P010".
	(10)	Replace "T7" with: "T10".
	(11)	Add: "TP7".
1771	(8)	Replace "P001 IBC02" with: "P010".
	(10)	Replace "T7" with: "T10".
	(11)	Add: "TP7".
1781	(8)	Replace "P001 IBC02" with: "P010".
	(10)	Replace "T7" with: "T10".
	(11)	Add: "TP7".
1784	(8)	Replace "P001 IBC02" with: "P010".
	(10)	Replace "T7" with: "T10".
	(11)	Add:

UN No.	Co-column	Amendment
		"TP7".
1790 (with more than 85% hydrogen fluoride)	(13)	Insert: "TA4 TT9". [Ref. doc.: ECE/TRANS/WP.15/AC.1/2007/18] Delete: "TM5". [Ref. doc.: INF.8 JM 03/07 + INF.49 JM 03/07]
1799	(8)	Replace "P001 IBC02" with: "P010".
	(10)	Replace "T7" with: "T10".
	(11)	Add: "TP7".
1800	(8)	Replace "P001 IBC02" with: "P010".
	(10)	Replace "T7" with: "T10".
	(11)	Add: "TP7".
1801	(8)	Replace "P001 IBC02" with: "P010".
	(10)	Replace "T7" with: "T10".
	(11)	Add: "TP7".
1804	(8)	Replace "P001 IBC02" with: "P010".
	(10)	Replace "T7" with: "T10".
	(11)	Add: "TP7".
1809	(10)	Replace "T14" with: "T20".
	(11)	Add: "T35".
1816	(8)	Replace "P001 IBC02" with: "P010".
	(10)	Replace "T7" with: "T10".
	(11)	Add: "TP7".
1818	(7a)	Replace "LQ22" with: "LQ0".
	(8)	Replace "P001 IBC02" with: "P010".
	(10)	Replace "T7" with: "T10".
1851, PG II and III	(9a)	Delete: "PP6".
1928	(9a)	Add:

UN No.	Co-lumn	Amendment
		"RR8". [Ref. doc.: TRANS/WP.15/AC.1/2006/15 + TRANS/WP.15/AC.1/2006/30 + INF.35 JM 09/06 as amended]
1987	(6)	Delete: "330" (three times).
1993	(6)	Delete: "330" (seven times).
1994	(10)	Insert: "T22".
	(11)	Insert: "TP2".
2031, PG II	(2)	After "with", add: "at least 65%, but".
	(5)	Insert: "+5.1"
	(9a)	Add: "B15".
	(20)	Replace "80" with: "85".
2059, PG II	(8)	After "P001", insert: "IBC02" (twice).
2059, PG III	(8)	After "P001", insert: "IBC03".
2212, PG II	(16)	Insert: "W11". [Ref. doc.: ECE/TRANS/WP.15/AC.1/2007/6]
2334	(10)	Replace "T14" with: "T20".
	(11)	Add: "T35".
2337	(10)	Replace "T14" with: "T20".
	(11)	Add: "T35".
2434	(8)	Replace "P001 IBC02" with: "P010".
	(10)	Replace "T7" with: "T10".
	(11)	Add: "TP7".
2435	(8)	Replace "P001 IBC02" with: "P010".
	(10)	Replace "T7" with: "T10".
	(11)	Add: "TP7".
2437	(8)	Replace "P001 IBC02" with: "P010".
	(10)	Replace "T7" with: "T10".
	(11)	Add: "TP7".
2465	(16)	Insert: "W11".

UN No.	Co-lumn	Amendment
2468	(16)	Insert: "W11".
2480	(10)	Insert: "T22".
	(11)	Insert: "TP2".
2590, PG III	(16)	Insert: "W11". [Ref. doc.: ECE/TRANS/WP.15/AC.1/2007/6]
2627	(16)	Insert: "W11".
2646	(10)	Replace "T14" with: "T20".
	(11)	Add: "T35".
2811, PG I	(16)	Insert: "W10/W12". [Ref. doc.: ECE/TRANS/WP.15/AC.1/2007/6]
2813, PG I	(10)	Insert: "T9".
	(11)	Insert: "TP7 TP33".
2814, third entry	(2)	Replace "(animal carcasses only)" with: "(animal material only)".
	(8)	Delete: "P099".
2823	(9a)	Insert: "B3".
2900, third entry	(2)	Replace "(animal carcasses and wastes only)" with: "(animal material only)".
	(8)	Delete: "P099".
2908	(8)	Replace "See 2.2.7" with: "See 1.7".
2909	(8)	Replace "See 2.2.7" with: "See 1.7".
2910	(8)	Replace "See 2.2.7" with: "See 1.7".
2911	(8)	Replace "See 2.2.7" with: "See 1.7".
2913	(6)	Insert: "336".
2916	(6)	Insert: "337".
2917	(6)	Insert: "337".
2921, PG I	(16)	Insert: "W10". [Ref. doc.: ECE/TRANS/WP.15/AC.1/2007/6]
2923, PG I	(16)	Insert: "W10". [Ref. doc.: ECE/TRANS/WP.15/AC.1/2007/6]
2928, PG I	(16)	Insert: "W10".

UN No.	Co-lumn	Amendment
		[Ref. doc.: ECE/TRANS/WP.15/AC.1/2007/6]
2930, PG I	(16)	Insert: "W10". [Ref. doc.: ECE/TRANS/WP.15/AC.1/2007/6]
2969, PG II	(16)	Insert: "W11". [Ref. doc.: ECE/TRANS/WP.15/AC.1/2007/6]
2985	(8)	Replace "P001 IBC02" with: "P010".
	(10)	Replace "T11" with: "T14".
	(11)	Add: "TP7".
2986	(8)	Replace "P001 IBC02" with: "P010".
	(10)	Replace "T11" with: "T14".
	(11)	Add: "TP7".
2987	(8)	Replace "P001 IBC02" with: "P010".
	(11)	Add: "TP7".
2988	(9a)	Add: "RR7". [Ref. doc.: TRANS/WP.15/AC.1/2006/15 + TRANS/WP.15/AC.1/2006/30 + INF.35 JM 09/06 as amended]
	(10)	Replace "T10" with: "T14".
3023	(10)	Replace "T14" with: "T20".
	(11)	Add: "T35".
3048	(6)	Delete: "61". [Ref. doc.: ECE/TRANS/WP.15/AC.1/2007/4]
3077	(6)	Replace "274 601" with: "274 335 601". [Ref. doc.: INF.34 JM 09/07]
	(10)	Add: "BK1 BK2".
	(17)	Replace "VW3" with: "VW1". [Ref. doc.: ECE/TRANS/WP.15/AC.1/2007/30 para 25]
3082	(6)	Replace "274 601" with: "274 335 601". [Ref. doc.: INF.34 JM 09/07]
	(9a)	Insert: "PP1".
3090	(2)	Amend to read as follows: "LITHIUM METAL BATTERIES (including lithium alloy batteries)". [Consequential amendment see under 2.2.9.3]
3091	(2)	Amend to read as follows:

UN No.	Co-lumn	Amendment
		"LITHIUM METAL BATTERIES CONTAINED IN EQUIPMENT (including lithium alloy batteries) or LITHIUM METAL BATTERIES PACKED WITH EQUIPMENT (including lithium alloy batteries)". [Consequential amendment see under 2.2.9.3]
3129	(9a)	Add: "RR7 RR8" (three times). [Ref. doc.: TRANS/WP.15/AC.1/2006/15 + TRANS/WP.15/AC.1/2006/30 + INF.35 JM 09/06 as amended]
3129, PG I	(10)	Insert: "T14".
	(11)	Insert: "TP2 TP7".
3129, PG II	(10)	Insert: "T11".
	(11)	Insert: "TP2".
3129, PG III	(10)	Insert: "T7".
	(11)	Insert: "TP1".
3130	(9a)	Add: "RR8". [Ref. doc.: TRANS/WP.15/AC.1/2006/15 + TRANS/WP.15/AC.1/2006/30 + INF.35 JM 09/06 as amended]
3131, PG I	(10)	Insert: "T9".
	(11)	Insert: "TP7 TP33".
3132	(1)- (20)	Delete the existing entries.
3135	(1)- (20)	Delete the existing entries.
3148	(9a)	Add: "RR8" (three times). [Ref. doc.: TRANS/WP.15/AC.1/2006/15 + TRANS/WP.15/AC.1/2006/30 + INF.35 JM 09/06 as amended]
3148, PG I	(10)	Insert: "T9".
	(11)	Insert: "TP2 TP7".
3148, PG II	(10)	Insert: "T7".
	(11)	Insert: "TP2".
3148, PG III	(10)	Insert: "T7".
	(11)	Insert: "TP1".
3152, PG II	(16)	Insert: "W11". [Ref. doc.: ECE/TRANS/WP.15/AC.1/2007/6]
3247	(16)	Insert: "W11".

UN No.	Co-lumn	Amendment
3248, PG II and III	(9a)	Delete: "PP6".
3249, PG II and III	(9a)	Delete: "PP6".
3269	(6)	Add: "340".
3288, PG I	(16)	Insert: "W10/W12". [Ref. doc.: ECE/TRANS/WP.15/AC.1/2007/6]
3290, PG I	(16)	Insert: "W10". [Ref. doc.: ECE/TRANS/WP.15/AC.1/2007/6]
3316	(6)	Add: "340".
3321	(6)	Insert: "336".
3322	(6)	Insert: "336".
3324	(6)	Insert: "336".
3325	(6)	Insert: "336".
3326	(6)	Insert: "336".
3328	(6)	Insert: "337".
3329	(6)	Insert: "337".
3344	(2)	After "TETRANITRATE", insert: "(PENTAERYTHRITOL TETRANITRATE; PETN)". [Consequential amendment see under 2.2.9.3]
3357	(7)	Replace "LQ4" with: "LQ0".
3361	(8)	Replace "P001 IBC01" with: "P010".
	(10)	Replace "T11" with: "T14".
	(11)	Add: "TP7".
3362	(8)	Replace "P001 IBC01" with: "P010".
	(10)	Replace "T11" with: "T14".
	(11)	Add: "TP7".
3391	(20)	Replace "333" with: "43". [Ref. doc.: 2006/2 + INF.34 JM 03/06]
3393	(20)	Replace "X333" with: "X432". [Ref. doc.: 2006/2 + INF.34 JM 03/06]
3432	(9a)	Adjacent to "IBC08", insert:

UN No.	Co-column	Amendment
		"B4".
	(16)	Insert: "W11".
3444, PG II	(16)	Insert: "W11". [Ref. doc.: ECE/TRANS/WP.15/AC.1/2007/6]
3468	(2)	At the end, add: "or HYDROGEN IN A METAL HYDRIDE STORAGE SYSTEM CONTAINED IN EQUIPMENT or HYDROGEN IN A METAL HYDRIDE STORAGE SYSTEM PACKED WITH EQUIPMENT".
3473	(2)	Replace "FUEL CELL CARTRIDGES" with "FUEL CELL CARTRIDGES or FUEL CELL CARTRIDGES CONTAINED IN EQUIPMENT or FUEL CELL CARTRIDGES PACKED WITH EQUIPMENT".
	(8)	Replace "P003" with: "P004".
	(9a)	Delete: "PP88".

Add the following new entries:

UN No.	Name and description	Class	Classification code	Packing group	Labels	Special provisions	Limited and excepted quantities		Packaging			Portable tanks and bulk containers		RID tanks		Transport category	Special provisions for carriage			Colis express	Hazard identification No.
									Packing instructions	Special packing provisions	Mixed packing provisions	Instructions	Special provisions	Tank code	Special provisions		Packages	Bulk	Loading, unloading and handling		
(1)	(2)	(3a)	(3b)	(4)	(5)	(6)	(7a)	(7b)	(8)	(9a)	(9b)	(10)	(11)	(12)	(13)	(15)	(16)	(17)	(18)	(19)	(20)
0505	SIGNALS, DISTRESS, ship	1	1.4G		1.4		LQ0	E0	P135		MP23 MP24					2	W2		CW1		1.4G
0506	SIGNALS, DISTRESS, ship	1	1.4S		1.4		LQ0	E0	P135		MP23 MP24					4	W2		CW1	CE1	1.4S
0507	SIGNALS, SMOKE	1	1.4S		1.4		LQ0	E0	P135		MP23 MP24					4	W2		CW1	CE1	1.4S
0508	1-HYDROXY-BENZOTRIAZOLE, ANHYDROUS, dry or wetted with less than 20% water, by mass	1	1.3C		1 (+13)		LQ0	E0	P114b	PP48 PP50	MP20					1	W2 W3		CW1		1.3C
2031	NITRIC ACID, other than red fuming, with less than 65% nitric acid	8	C1	II	8		LQ22	E2	P001 IBC02	PP81 B15	MP15	T8	TP2	L4BN		2				CE6	80
3132	WATER-REACTIVE SOLID, FLAMMABLE, N.O.S.	4.3	WF2	I	4.3 + 4.1	274	LQ0	E0	P403 IBC99		MP2					0	W1		CW23		X423
3132	WATER-REACTIVE SOLID, FLAMMABLE, N.O.S.	4.3	WF2	II	4.3 + 4.1	274	LQ11	E2	P410 IBC04		MP14	T3	TP33	SGAN L4DH	TU14 TE21 TM2	0	W1		CW23		423
3132	WATER-REACTIVE SOLID, FLAMMABLE, N.O.S.	4.3	WF2	III	4.3 + 4.1	274	LQ12	E1	P410 IBC06		MP14	T1	TP33	SGAN L4DH	TU14 TE21 TM2	0	W1		CW23		423
3135	WATER-REACTIVE SOLID, SELF-HEATING, N.O.S.	4.3	WS	I	4.3 + 4.2	274	LQ0	E0	P403		MP2					1	W1		CW23		X423
3135	WATER-REACTIVE SOLID, SELF-HEATING, N.O.S.	4.3	WS	II	4.3 + 4.2	274	LQ11	E2	P410 IBC05		MP14	T3	TP33	SGAN L4DH	TU14 TE21 TM2	2	W1		CW23		423
3135	WATER-REACTIVE SOLID, SELF-HEATING, N.O.S.	4.3	WS	III	4.3 + 4.2	274	LQ12	E1	P410 IBC08	B4	MP14	T1	TP33	SGAN L4DH	TU14 TE21 TM2	3	W1		CW23		423
3373	BIOLOGICAL SUBSTANCE, CATEGORY B (animal material only)	6.2	I4		6.2	319	LQ0	E0	P650			T1 BK1 BK2	TP1	L4BH	TU15 TU37	-				CE14	606
3474	1-HYDROXYBENZOTRIAZOLE, ANHYDROUS, WETTED with not less than 20% water, by mass	4.1	D	I	4.1		LQ0	E0	P406	PP48	MP2					1	W1				40

UN No.	Name and description	Class	Classification code	Packing group	Labels	Special provisions	Limited and excepted quantities		Packaging			Portable tanks and bulk containers		RID tanks		Transport category	Special provisions for carriage			Colis express	Hazard identification No.
									Packing instructions	Special packing provisions	Mixed packing provisions	Instructions	Special provisions	Tank code	Special provisions		Packages	Bulk	Loading, unloading and handling		
(1)	(2)	(3a)	(3b)	(4)	(5)	(6)	(7a)	(7b)	(8)	(9a)	(9b)	(10)	(11)	(12)	(13)	(15)	(16)	(17)	(18)	(19)	(20)
3475	ETHANOL AND GASOLINE MIXTURE or ETHANOL AND MOTOR SPIRIT MIXTURE or ETHANOL AND PETROL MIXTURE, with more than 10% ethanol	3	F1	II	3	333	LQ4	E2	P001 IBC02		MP19	T4	TP1	LGBF		2				CE7	33
3476	FUEL CELL CARTRIDGES or FUEL CELL CARTRIDGES CONTAINED IN EQUIPMENT or FUEL CELL CARTRIDGES PACKED WITH EQUIPMENT, containing water-reactive substances	4.3	W3		4.3	328 334	LQ10 LQ11	E0	P004							3	W1		CW23	CE2	423
3477	FUEL CELL CARTRIDGES or FUEL CELL CARTRIDGES CONTAINED IN EQUIPMENT or FUEL CELL CARTRIDGES PACKED WITH EQUIPMENT, containing corrosive substances	8	C11		8	328 334	LQ12 LQ13	E0	P004							3				CE8	80
3478	FUEL CELL CARTRIDGES or FUEL CELL CARTRIDGES CONTAINED IN EQUIPMENT or FUEL CELL CARTRIDGES PACKED WITH EQUIPMENT, containing liquefied flammable gas	2	6F		2.1	328 338	LQ1	E0	P004							2			CW9 CW12	CE3	23
3479	FUEL CELL CARTRIDGES or FUEL CELL CARTRIDGES CONTAINED IN EQUIPMENT or FUEL CELL CARTRIDGES PACKED WITH EQUIPMENT, containing hydrogen in metal hydride	2	6F		2.1	328 339	LQ1	E0	P004							2			CW9 CW12	CE3	23
3480	LITHIUM ION BATTERIES (including lithium ion polymer batteries)	9	M4	II	9	188 230 310 636	LQ0	E0	P903 P903a P903b							2				CE2	90

(1)	(2)	(3a)	(3b)	(4)	(5)	Special provisions		Packaging			Portable tanks and bulk containers		RID tanks		Transport category	Special provisions for carriage			(19)	(20)	
						(6)	(7a)	(7b)	(8)	(9a)	(9b)	(10)	(11)	(12)		(13)	(16)	(17)			(18)
3481	LITHIUM ION BATTERIES CONTAINED IN EQUIPMENT (including lithium ion polymer batteries) or LITHIUM ION BATTERIES PACKED WITH EQUIPMENT (including lithium ion polymer batteries)	9	M4	II	9	188 230 636	LQ0	E0	P903 P903a P903b							2				CE2	90

[Ref. doc. for UN Nos. 3132 and 3135: TRANS/WP.15/AC.1/2006/29 as amended]

[Consequential amendments see under 2.2.9.3 und 4.1.40.4 MP 24]

Table B

Insert the following new entries:

Name and description	UN No.	Note	NHM-Code
ETHANOL AND GASOLINE MIXTURE, with more than 10% ethanol	3475		???????
ETHANOL AND MOTOR SPIRIT MIXTURE, with more than 10% ethanol	3475		???????
ETHANOL AND PETROL MIXTURE, with more than 10% ethanol	3475		???????
FUEL CELL CARTRIDGES CONTAINED IN EQUIPMENT, containing corrosive substances	3477		???????
FUEL CELL CARTRIDGES CONTAINED IN EQUIPMENT containing flammable liquids	3473		850680
FUEL CELL CARTRIDGES CONTAINED IN EQUIPMENT, containing hydrogen in metal hydride	3479		???????
FUEL CELL CARTRIDGES CONTAINED IN EQUIPMENT, containing liquefied flammable gas	3478		???????
FUEL CELL CARTRIDGES CONTAINED IN EQUIPMENT, containing water-reactive substances	3476		???????
FUEL CELL CARTRIDGES, containing corrosive substances	3477		???????
FUEL CELL CARTRIDGES, containing hydrogen in metal hydride	3479		???????
FUEL CELL CARTRIDGES, containing liquefied flammable gas	3478		???????
FUEL CELL CARTRIDGES, containing water-reactive substances	3476		???????
FUEL CELL CARTRIDGES PACKED WITH EQUIPMENT, containing corrosive substances	3477		???????
FUEL CELL CARTRIDGES PACKED WITH EQUIPMENT containing flammable liquids	3473		850680
FUEL CELL CARTRIDGES PACKED WITH EQUIPMENT, containing hydrogen in metal hydride	3479		???????
FUEL CELL CARTRIDGES PACKED WITH EQUIPMENT, containing liquefied flammable gas	3478		???????
FUEL CELL CARTRIDGES PACKED WITH EQUIPMENT, containing water-reactive substances	3476		???????
HYDROGEN IN A METAL HYDRIDE STORAGE SYSTEM CONTAINED IN EQUIPMENT	3468		285000
HYDROGEN IN A METAL HYDRIDE STORAGE SYSTEM PACKED WITH EQUIPMENT	3468		285000
1-HYDROXY-BENZOTRIAZOLE, ANHYDROUS, dry or wetted with less than 20% water, by mass	0508		???????
1-HYDROXYBENZOTRIAZOLE, ANHYDROUS, WETTED with not less than 20% water, by mass	3474		???????
LITHIUM ION BATTERIES CONTAINED IN EQUIPMENT (including lithium ion polymer batteries)	3481		???????
LITHIUM ION BATTERIES (including lithium ion polymer batteries)	3480		???????
LITHIUM ION BATTERIES PACKED WITH EQUIPMENT (including lithium ion polymer batteries)	3481		???????
PENTAERYTHRITOL TETRANITRATE MIXTURE, DESENSITIZED, SOLID, N.O.S. with more than 10%	3344		292090

but not more than 20% PETN, by mass			
PETN MIXTURE, DESENSITIZED, SOLID, N.O.S. with more than 10% but not more than 20% PETN, by mass	3344		292090
PICRIC ACID, WETTED with not less than 30% water, by mass	1344		290890
SIGNALS, DISTRESS, ship	0505		360490
SIGNALS, DISTRESS, ship	0506		360490
SIGNALS, SMOKE	0507		360490

Amend Table B as follows:

Name and description	UN No.	Amendment
LITHIUM BATTERIES	3090	Amend the name to read as follows: "LITHIUM METAL BATTERIES (including lithium alloy batteries)".
LITHIUM BATTERIES CONTAINED IN EQUIPMENT	3091	Amend the name to read as follows: "LITHIUM BATTERIES CONTAINED IN EQUIPMENT (including lithium alloy batteries)".
LITHIUM BATTERIES PACKED WITH EQUIPMENT	3091	Amend the name to read as follows: "LITHIUM METAL BATTERIES PACKED WITH EQUIPMENT (including lithium alloy batteries)".
WATER-REACTIVE SOLID, FLAMMABLE, N.O.S.	3132	In column "Note", delete: "Prohibited". [Ref. doc.: TRANS/WP.15/AC.1/2006/29 as amended]
WATER-REACTIVE SOLID, SELF-HEATING, N.O.S.	3135	In column "Note", delete: "Prohibited". [Ref. doc.: TRANS/WP.15/AC.1/2006/29 as amended]

Chapter 3.3

3.3.1

SP 188

At the beginning, replace "Lithium cells" with:

"Cells".

In (a), replace "lithium equivalent content is not more than 1.5 g" with:

"Watt-hour rating is not more than 20 Wh".

In (b), replace "aggregate lithium-equivalent content is not more than 8 g;" with:

"Watt-hour rating is not more than 100 Wh. Lithium ion batteries subject to this provision shall be marked with the Watt-hour rating on the outside case;".

Replace (d) and (e) with the following new sub-paragraphs (d) to (i):

"(d) Cells and batteries, except when installed in equipment, shall be packed in inner packagings that completely enclose the cell or battery. Cells and batteries shall be protected so as to prevent short circuits. This includes protection against contact with conductive materials within the same packaging that could lead to a

short circuit. The inner packagings shall be packed in strong outer packagings which conform to the provisions of 4.1.1.1, 4.1.1.2 and 4.1.1.5;

- (e) Cells and batteries when installed in equipment shall be protected from damage and short circuit, and the equipment shall be equipped with an effective means of preventing accidental activation. When batteries are installed in equipment, the equipment shall be packed in strong outer packagings constructed of suitable material of adequate strength and design in relation to the packaging's capacity and its intended use unless the battery is afforded equivalent protection by the equipment in which it is contained;
- (f) Except for packages containing no more than four cells installed in equipment or no more than two batteries installed in equipment, each package shall be marked with the following:
 - (i) an indication that the package contains "LITHIUM METAL" or "LITHIUM ION" cells or batteries, as appropriate;
 - (ii) an indication that the package shall be handled with care and that a flammability hazard exists if the package is damaged;
 - (iii) an indication that special procedures shall be followed in the event the package is damaged, to include inspection and repacking if necessary; and
 - (iv) a telephone number for additional information;
- (g) Each consignment of one or more packages marked in accordance with paragraph (f) shall be accompanied with a document including the following:
 - (i) an indication that the package contains "LITHIUM METAL" or "LITHIUM ION" cells or batteries, as appropriate;
 - (ii) an indication that the package shall be handled with care and that a flammability hazard exists if the package is damaged;
 - (iii) an indication that special procedures shall be followed in the event the package is damaged, to include inspection and repacking if necessary; and
 - (iv) a telephone number for additional information;
- (h) Except when batteries are installed in equipment, each package shall be capable of withstanding a 1.2 m drop test in any orientation without damage to cells or batteries contained therein, without shifting of the contents so as to allow battery to battery (or cell to cell) contact and without release of contents; and
- (i) Except when batteries are installed in or packed with equipment, packages shall not exceed 30 kg gross mass."

In the last sentence, delete:

", except in the case of a lithium ion cell the "lithium-equivalent content" in grams is calculated to be 0.3 times the rated capacity in ampere hours".

Insert a new last paragraph to read as follows:

"Separate entries exist for lithium metal batteries and lithium ion batteries to facilitate the carriage of these batteries for specific modes of carriage and to enable the application of different emergency response actions."

SP 198 Replace "and 3066" with:

", 3066, 3469 and 3470".

SP 199 Replace "are considered insoluble. See ISO 3711:1990 "Lead chromate pigments and lead chromate – molybdate pigments – Specifications and methods of test"." with:

"(see ISO 3711:1990 "Lead chromate pigments and lead chromate – molybdate pigments – Specifications and methods of test") are considered insoluble and are not subject to the requirements of RID unless they meet the criteria for inclusion in another class."

SP 201 Add the following Note:

"NOTE: For waste lighters collected separately see Chapter 3.3, special provision 654."

[Ref. doc.: INF.21 JM 03/07]

SP 236 In the last sentence, replace "Column (7)" with:

"column (7a)".

SP 251 In the first paragraph, replace "Column (7)" with:

"column (7a)".

In the last paragraph after "quantity limits", insert:

"for limited quantities".

In the last paragraph, replace "Column (7)" with:

"column (7a)".

SP 289 Replace "Air bags or seat-belts" with:

"Air bag inflators, air bag modules or seat-belt pretensioners".

SP 290 Replace "2.2.7.9.1" with:

"1.7.1.5".

[Consequential amendment]

SP 307 In (b) after "dolomite", insert:

"and/or mineral calcium sulphate".

- SP 310** In the first sentence, replace "lithium cells" with:
"cells" (twice).
- SP 328** Amend to read as follows:
- "328** This entry applies to fuel cell cartridges including when contained in equipment or packed with equipment. Fuel cell cartridges installed in or integral to a fuel cell system are regarded as contained in equipment. Fuel cell cartridge means an article that stores fuel for discharge into the fuel cell through a valve(s) that controls the discharge of fuel into the fuel cell. Fuel cell cartridges, including when contained in equipment, shall be designed and constructed to prevent fuel leakage under normal conditions of carriage.
- Fuel cell cartridge design types using liquids as fuels shall pass an internal pressure test at a pressure of 100 kPa (gauge) without leakage.
- Except for fuel cell cartridges containing hydrogen in metal hydride which shall be in compliance with special provision 339, each fuel cell cartridge design type shall be shown to pass a 1.2 meter drop test onto an unyielding surface in the orientation most likely to result in failure of the containment system with no loss of contents."
- SP 330** Amend to read as follows:
- "330** (Deleted)".
- SP 636** Amend to read as follows:
- "636** (a) Cells contained in equipment shall not be capable of being discharged during carriage to the extent that the open circuit voltage falls below 2 volts or two thirds of the voltage of the undischarged cell, whichever is the lower.
- (b) Used lithium cells and batteries with a gross mass of not more than 500 g each collected and presented for carriage for disposal between the consumer collecting point and the intermediate processing facility, together with other non-lithium cells or batteries, are not subject to the other provisions of RID if they meet the following conditions:
- (i) The provisions of packing instruction P903b are complied with;
- (ii) A quality assurance system is in place to ensure that the total amount of lithium cells or batteries in each wagon or large container does not exceed 333 kg;
- (iii) Packages shall bear the inscription: "USED LITHIUM CELLS"."
- [Ref. doc.: ECE/TRANS/WP.15/AC.1/2007/21 + INF.48/Rev.1 JM 03/07]
- Add the following new special provisions:
- "332** Magnesium nitrate hexahydrate is not subject to the requirements of RID.
- 333** Ethanol and gasoline, motor spirit or petrol mixtures for use in spark-ignition engines (e.g. in automobiles, stationary engines and other engines) shall be assigned to this entry regardless of variations in volatility.

- 334** A fuel cell cartridge may contain an activator provided it is fitted with two independent means of preventing unintended mixing with the fuel during carriage.
- 335** Mixtures of solids which are not subject to the requirements of RID and environmentally hazardous liquids or solids shall be classified as UN 3077 and may be carried under this entry provided there is no free liquid visible at the time the substance is loaded or at the time the packaging or wagon or container is closed. Each wagon or container shall be leakproof when used for carriage in bulk. If free liquid is visible at the time the mixture is loaded or at the time the packaging or wagon or container is closed, the mixture shall be classified as UN 3082. Sealed packets and articles containing less than 10 ml of an environmentally hazardous liquid, absorbed into a solid material but with no free liquid in the packet or article, or containing less than 10 g of an environmentally hazardous solid, are not subject to the requirements of RID.
- [Ref. doc.: INF.34 JM 09/07]
- 336** A single package of non-combustible solid LSA-II or LSA-III material, if carried by air, shall not contain an activity greater than 3 000 A₂.
- 337** Type B(U) and Type B(M) packages, if carried by air, shall not contain activities greater than the following:
- (a) For low dispersible radioactive material: as authorized for the package design as specified in the certificate of approval;
 - (b) For special form radioactive material: 3 000 A₁ or 100 000 A₂, whichever is the lower; or
 - (c) For all other radioactive material: 3 000 A₂.
- 338** Each fuel cell cartridge carried under this entry and designed to contain a liquefied flammable gas shall:
- (a) Be capable of withstanding, without leakage or bursting, a pressure of at least two times the equilibrium pressure of the contents at 55 °C;
 - (b) Not contain more than 200 ml of liquefied flammable gas with a vapour pressure not exceeding 1 000 kPa at 55 °C; and
 - (c) Pass the hot water bath test prescribed in 6.2.6.3.1 of Chapter 6.2.
- 339** Fuel cell cartridges containing hydrogen in a metal hydride carried under this entry shall have a water capacity less than or equal to 120 ml.
- The pressure in the fuel cell cartridge shall not exceed 5 MPa at 55 °C. The design type shall withstand, without leaking or bursting, a pressure of twice the design pressure of the cartridge at 55 °C or 200 kPa more than the design pressure of the cartridge at 55 °C, whichever is greater. The pressure at which this test is conducted is referred to in the drop test and the hydrogen cycling test as the "minimum shell burst pressure".
- Fuel cell cartridges shall be filled in accordance with procedures provided by the manufacturer. The manufacturer shall provide the following information with each fuel cell cartridge:
- (a) Inspection procedures to be carried out before initial filling and before refilling of the fuel cell cartridge;

- (b) Safety precautions and potential hazards to be aware of;
- (c) Method for determining when the rated capacity has been achieved;
- (d) Minimum and maximum pressure range;
- (e) Minimum and maximum temperature range; and
- (f) Any other requirements to be met for initial filling and refilling including the type of equipment to be used for initial filling and refilling.

The fuel cell cartridges shall be designed and constructed to prevent fuel leakage under normal conditions of carriage. Each cartridge design type, including cartridges integral to a fuel cell, shall be subjected to and shall pass the following tests:

Drop test

A 1.8 metre drop test onto an unyielding surface in four different orientations:

- (a) Vertically, on the end containing the shut-off valve assembly;
- (b) Vertically, on the end opposite to the shut-off valve assembly;
- (c) Horizontally, onto a steel apex with a diameter of 38 mm, with the steel apex in the upward position; and
- (d) At a 45° angle on the end containing the shut-off valve assembly.

There shall be no leakage, determined by using a soap bubble solution or other equivalent means on all possible leak locations, when the cartridge is charged to its rated charging pressure. The fuel cell cartridge shall then be hydrostatically pressurized to destruction. The recorded burst pressure shall exceed 85% of the minimum shell burst pressure.

Fire test

A fuel cell cartridge filled to rated capacity with hydrogen shall be subjected to a fire engulfment test. The cartridge design, which may include a vent feature integral to it, is deemed to have passed the fire test if:

- (a) The internal pressure vents to zero gauge pressure without rupture of the cartridge; or
- (b) The cartridge withstands the fire for a minimum of 20 minutes without rupture.

Hydrogen cycling test

This test is intended to ensure that a fuel cell cartridge design stress limits are not exceeded during use.

The fuel cell cartridge shall be cycled from not more than 5% rated hydrogen capacity to not less than 95% rated hydrogen capacity and back to not more than 5% rated hydrogen capacity. The rated charging pressure shall be used for charging and temperatures shall be held within the operating temperature range. The cycling shall be continued for at least 100 cycles.

Following the cycling test, the fuel cell cartridge shall be charged and the water volume displaced by the cartridge shall be measured. The cartridge design is deemed to have passed the hydrogen cycling test if the water volume displaced by the cycled cartridge does not exceed the water volume displaced by an uncycled cartridge charged to 95% rated capacity and pressurized to 75% of its minimum shell burst pressure.

Production leak test

Each fuel cell cartridge shall be tested for leaks at $15\text{ }^{\circ}\text{C} \pm 5\text{ }^{\circ}\text{C}$, while pressurized to its rated charging pressure. There shall be no leakage, determined by using a soap bubble solution or other equivalent means on all possible leak locations.

Each fuel cell cartridge shall be permanently marked with the following information:

- (a) The rated charging pressure in MPa;
- (b) The manufacturer's serial number of the fuel cell cartridges or unique identification number; and
- (c) The date of expiry based on the maximum service life (year in four digits; month in two digits).

340 Chemical kits, first aid kits and polyester resin kits containing dangerous substances in inner packagings which do not exceed the quantity limits for excepted quantities applicable to individual substances as specified in column (7b) of Table A of Chapter 3.2, may be carried in accordance with Chapter 3.5. Class 5.2 substances, although not individually authorized as excepted quantities in column (7b) of Table A of Chapter 3.2, are authorized in such kits and are assigned Code E2 (see 3.5.1.2).

341 (Reserved)".

"654 Waste lighters collected separately and consigned in accordance with 5.4.1.1.3 may be carried under this entry for the purposes of disposal. They need not be protected against inadvertent discharge provided that measures are taken to prevent the dangerous build up of pressure and dangerous atmospheres.

Waste lighters, other than those leaking or severely deformed, shall be packed in accordance with packing instruction P003. In addition the following provisions shall apply:

- only rigid packagings of a maximum capacity of 60 litres shall be used;
- the packagings shall be filled with water or any other appropriate protection material to avoid any ignition;
- under normal conditions of carriage all ignition devices of the lighters shall fully be covered by the protection material;
- the packagings shall be adequately vented to prevent the creation of flammable atmosphere and the build up of pressure;
- the packages shall only be carried in ventilated or open wagons or containers.

Leaking or severely deformed lighters shall be carried in salvage packagings, provided appropriate measures are taken to ensure there is no dangerous build up of pressure.

NOTE: Special provision 201 and special packing provisions PP84 and RR5 of packing instruction P002 in 4.1.4.1 do not apply to waste lighters."

[Ref. doc.: INF.21 JM 03/07]

Kapitel 3.4

3.4 Amend the heading to read as follows:

"Dangerous goods packed in limited quantities".

**3.4.2,
3.4.3,
3.4.4 and
3.4.5**

Replace "Column (7)" with:

"column (7a)".

3.4.3 (b) Replace "6.2.1.2 and 6.2.4.1 to 6.2.4.3" with:

"6.2.5.1 and 6.2.6.1 to 6.2.6.3".

[Ref. doc.: INF.32 JM 03/07]

Add the following new sections:

"3.4.8

The requirements

- (a) of 5.2.1.9 on the placement of orientation arrows on packages;
- (b) of 5.1.2.1 (b) on the placement of orientation arrows on overpacks; and
- (c) of 7.5.1.5 on the orientation of packages

shall be applicable also to packages and overpacks carried in accordance with this chapter."

[Ref. doc.: ECE/TRANS/WP.15/AC.1/2007/2 as amended]

3.4.9

Consignors of dangerous goods packed in limited quantities shall inform the carrier of the total gross mass of such goods to be consigned, in advance of carriage not involving maritime transport.

3.4.10

- (a) Wagons carrying packages with dangerous goods in limited quantities shall be marked in accordance with 3.4.12 on both sides except when orange-coloured plate marking is displayed in accordance with 5.3.2.
- (b) Large containers carrying packages with dangerous goods in limited quantities shall be marked in accordance with 3.4.12 on all four sides except when placards in accordance with 5.3.1 are already affixed.

If the marking affixed to the large containers is not visible from outside the carrying wagon, the same marking shall also be affixed to both sides of the wagon.

3.4.11 Markings specified in 3.4.10 may be dispensed with, if the total gross mass of the packages containing dangerous goods packed in limited quantities carried does not exceed 8 tonnes per wagon or large container.

3.4.12 The marking shall consist of "LTD QTY"* in black letters not less than 65 mm high on a white background.

Markings according to chapter 3.4 of the IMDG Code are also acceptable.

* The letters "LTD QTY" are an abbreviation of the English words "Limited Quantity".

[Ref. doc.: INF.59 JM 09/07 as amended]

Insert a new Chapter 3.5 to read as follows:

"Chapter 3.5

Dangerous Goods packed in excepted quantities

3.5.1 Excepted quantities

3.5.1.1 Excepted quantities of dangerous goods of certain classes, other than articles, meeting the provisions of this Chapter are not subject to any other provisions of RID except for:

- (a) The training requirements in Chapter 1.3;
- (b) The classification procedures and packing group criteria in Part 2;
- (c) The packaging requirements of 4.1.1.1, 4.1.1.2, 4.1.1.4 and 4.1.1.6.

NOTE: In the case of radioactive material, the requirements for radioactive material in excepted packages in 1.7.1.5 apply.

3.5.1.2 Dangerous goods which may be carried as excepted quantities in accordance with the provisions of this Chapter are shown in column (7b) of Table A of Chapter 3.2 list by means of an alphanumeric code as follows:

Code	Maximum net quantity per inner packaging (in grams for solids and ml for liquids and gases)	Maximum net quantity per outer packaging (in grams for solids and ml for liquids and gases, or sum of grams and ml in the case of mixed packing)
E0	Not permitted as Excepted Quantity	
E1	30	1000
E2	30	500
E3	30	300
E4	1	500
E5	1	300

For gases, the volume indicated for inner packagings refers to the water capacity of the inner receptacle and the volume indicated for outer packagings refers to the combined water capacity of all inner packagings within a single outer packaging.

[Ref. doc.: INF.34 JM 09/07]

3.5.1.3 Where dangerous goods in excepted quantities for which different codes are assigned are packaged together the total quantity per outer packaging shall be limited to that corresponding to the most restrictive code.

3.5.2 Packagings

Packagings used for the carriage of dangerous goods in excepted quantities shall be in compliance with the following:

- (a) There shall be an inner packaging and each inner packaging shall be constructed of plastic (with a minimum thickness of 0.2 mm when used for liquids), or of glass, porcelain, stoneware, earthenware or metal (see also 4.1.1.2) and the closure of each inner packaging shall be held securely in place with wire, tape or other positive means; any receptacle having a neck with moulded screw threads shall have a leak proof threaded type cap. The closure shall be resistant to the contents;
- (b) Each inner packaging shall be securely packed in an intermediate packaging with cushioning material in such a way that, under normal conditions of carriage, they cannot break, be punctured or leak their contents. The intermediate packaging shall completely contain the contents in case of breakage or leakage, regardless of package orientation. For liquids, the intermediate packaging shall contain sufficient absorbent material to absorb the entire contents of the inner packaging. In such cases, the absorbent material may be the cushioning material. Dangerous goods shall not react dangerously with cushioning, absorbent material and packaging material or reduce the integrity or function of the materials;
- (c) The intermediate packaging shall be securely packed in a strong, rigid outer packaging (wooden, fibreboard or other equally strong material);
- (d) Each package type shall be in compliance with the provisions in 3.5.3;
- (e) Each package shall be of such a size that there is adequate space to apply all necessary markings; and
- (f) Overpacks may be used and may also contain packages of dangerous goods or goods not subject to the requirements of RID.

3.5.3 Tests for packages

3.5.3.1 The complete package as prepared for carriage, with inner packagings filled to not less than 95% of their capacity for solids or 98% for liquids, shall be capable of withstanding, as demonstrated by testing which is appropriately documented, without breakage or leakage of any inner packaging and without significant reduction in effectiveness:

- (a) Drops onto a rigid, non-resilient flat and horizontal surface from a height of 1.8 m:
 - (i) Where the sample is in the shape of a box, it shall be dropped in each of the following orientations:
 - flat on the base;
 - flat on the top;

- flat on the longest side;
 - flat on the shortest side;
 - on a corner;
- (ii) Where the sample is in the shape of a drum, it shall be dropped in each of the following orientations:
- diagonally on the top chime, with the centre of gravity directly above the point of impact;
 - diagonally on the base chime;
 - flat on the side;

NOTE: Each of the above drops may be performed on different but identical packages.

- (b) A force applied to the top surface for a duration of 24 hours, equivalent to the total weight of identical packages if stacked to a height of 3 m (including the drop sample).

3.5.3.2 For the purposes of testing, the substances to be carried in the packaging may be replaced by other substances except where this would invalidate the results of the tests. For solids, when another substance is used, it must have the same physical characteristics (mass, grain size, etc.) as the substance to be carried. In the drop tests for liquids, when another substance is used, its relative density (specific gravity) and viscosity should be similar to those of the substance to be carried.

3.5.4 Marking of packages

3.5.4.1 Packages containing excepted quantities of dangerous goods prepared in accordance with this Chapter shall be durably and legibly marked with the mark shown in 3.5.4.2. The first or only label number indicated in column (5) of Table A of Chapter 3.2 for each of the dangerous goods contained in the package shall be shown in the mark. Where the name of the consignor or consignee is not shown elsewhere on the package this information shall be included within the mark.

3.5.4.2 The dimensions of the mark shall be a minimum of 100 mm × 100 mm.

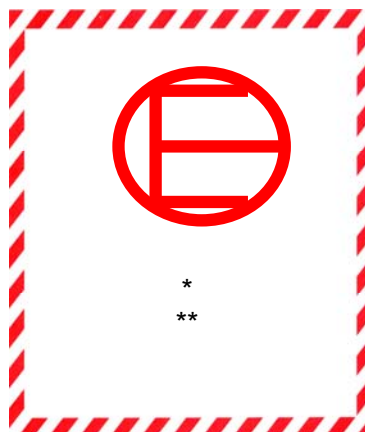

Excepted quantities mark

Hatching and symbol of the same colour, black or red,
on white or suitable contrasting background

- * The first or only label number indicated in column (5) of Table A of Chapter 3.2 shall be shown in this location.
- ** The name of the consignor or of the consignee shall be shown in this location if not shown elsewhere on the package.

3.5.4.3 An overpack containing dangerous goods in excepted quantities shall display the markings required by 3.5.4.1, unless such markings on packages within the overpack are clearly visible.

3.5.5 Maximum number of packages in any wagon or container

The number of packages in any wagon or container shall not exceed 1 000.

3.5.6 Documentation

If a document or documents (such as a bill of lading, air waybill or CMR/CIM consignment note) accompanies(y) dangerous goods in excepted quantities, at least one of these documents shall include the statement "DANGEROUS GOODS IN EXCEPTED QUANTITIES" and indicate the number of packages."

PART 4

Chapter 4.1

4.1.1 In the Note after the heading after "P201", add:

"and LP02".

[Ref. doc.: INF.34 JM 09/07]

4.1.1.10 In the last sentence before the Table, delete:

"Metal".

4.1.1.16 Replace "6.2.5.8, 6.2.5.9," with:

"6.2.2.7, 6.2.2.8,".

[Ref. doc.: INF.32 JM 03/07]

4.1.2.2 Replace the three first letters (a), (b) and (c) with dashes (the text remains unchanged).

4.1.3.6.1 In the last sub-paragraph, delete:

"and in 4.1.4.4".

[Ref. doc.: TRANS/WP.15/AC.1/2006/15 + TRANS/WP.15/AC.1/2006/30 + INF.35 JM 09/06 as amended]

4.1.4.1

P 001 Amend the beginning of special packing provision **PP 1** to read as follows:

"For UN Nos. 1133, 1210, 1263 and 1866 and for adhesives, printing inks, printing ink related materials, paints, paint related materials and resin solutions which are assigned to UN 3082, metal or plastics packagings for substances of packing groups II and III in quantities of 5 litres or less per packaging are not required to meet the performance tests in Chapter 6.1 when carried:" ((a) and (b) unchanged).

Amend **PP 6** to read as follows:

"**PP 6** (Deleted)".

P 002 Amend **PP 6** to read as follows:

"**PP6** (Deleted)".

Add the following Note to special packing provisions **PP 84** and **RR 5**:

"**NOTE:** For waste lighters collected separately see Chapter 3.3, special provision 654."

[Ref. doc.: INF.21 JM 03/07]

P 003 Amend **PP 88** to read as follows:

"**PP 88** (Deleted)".

P 099 Before "by the competent authority", insert:

"for these goods".

Add the following new sentence at the end:

"A copy of the competent authority approval shall accompany each consignment or the transport document shall include an indication that the packaging was approved by the competent authority."

P 114b Add the following new special packing provision:

"PP 48 For UN No. 0508, metal packagings shall not be used."

In special packing provision **PP 50**, replace "For UN Nos. 0160 and 0161" with:

"For UN Nos. 0160, 0161 and 0508".

In special packing provision **PP 50**, replace "required" with:

"necessary".

P 200 In paragraph (2), add the following text at the end:

"Pressure relief devices shall be fitted on UN pressure receptacles used for the carriage of UN No. 1013 carbon dioxide and UN No. 1070 nitrous oxide."

[Ref. doc.: ECE/TRANS/WP.15/AC.1/2007/18]

In paragraph (5) (b), amend the second sentence to read as follows:

"The use of test pressures and filling ratios other than those in the Table is permitted, except where, special packing provision "o" applies, provided that:

- (i) the criterion of, special packing provision "r" is met when applicable; or
- (ii) the above criterion is met in all other cases."

In paragraph (8), replace "6.2.1.6" with:

"6.2.1.6 and 6.2.3.5 respectively".

[Ref. doc.: ECE/TRANS/WP.15/AC.1/2007/18 + INF.32 JM 03/07 + INF.21 JM 09/07]

Amend paragraph (10) as follows:

- In the third paragraph of special packing provision "k", replace "assemblies (groups)" with:

"groups".

- Amend special packing provision "n" to read as follows:

"n: Cylinders and individual cylinders in a bundle shall contain not more than 5 kg of the gas. When bundles containing UN 1045 Fluorine, compressed are divided into groups of cylinders in accordance with special packing provision "k" each group shall contain not more than 5 kg of the gas."

- Insert a new special packing provision "r" to read as follows:

"r: The filling ratio of this gas shall be limited such that, if complete decomposition occurs, the pressure does not exceed two thirds of the test pressure of the pressure receptacle."

Current special packing provision "r" becomes "ra".

- Add a new paragraph at the end of special packing provision "z" to read as follows:

"Mixtures containing UN 2192 germane, other than mixtures of up to 35% germane in hydrogen or nitrogen or up to 28% germane in helium or argon, shall be filled to a pressure such that, if complete decomposition of the germane occurs, two thirds of the test pressure of the pressure receptacle shall not be exceeded."

In paragraph (11), in the table, replace "EN 1439:2005 (except 3.5 and Annex C)" with:

["EN 1439:2008 (except 3.5 and Annex C)"].

[Ref. doc.: INF.51 JM 09/07]

Amend Table 1 as follows:

- In column "Text pressure" for UN 1660, replace "200" with:
"225".
- In column "Maximum working pressure" for UN 1660, replace "50" with:
"33".

Amend Table 2 as follows:

- Everywhere it appears, replace special packing provision "r" with:
"ra".
- In column "Classification code" for UN 1017 replace "2TC" with:
"2TOC".

[Consequential amendment]

- In column "Test pressure" for UN 2189, replace "10" with:
"200".
- In column "Filling ration" for UN 2189, replace "0,90" with:
"1,08".
- In column "Filling ratio" for UN 2192 replace "1.02" with:
"0.064".
- In column "Special packing provisions" for UN 2192, add:
", r".

- In column "Special packing provisions" for UN 2203 delete:
"d, "(twice).
- In column "Special packing provisions" for UN 2676, insert before "ra":
"r,".
- In Table 2, amend the values in column "Filling ratio" as follows:

UN No.	Name and description	Test pressure, bar	Filling ratio
1011	BUTANE	10	0,52
1013	CARBON DIOXIDE	190	0,68
1013	CARBON DIOXIDE	250	0,76
1020	CHLOROPENTAFLUOROETHANE (R 115)	25	1,05
1022	CHLOROTRIFLUOROMETHANE (R 13)	250	1,11
1035	ETHANE	120	0,30
1035	ETHANE	300	0,40
1048	HYDROGEN BROMIDE	60	1,51
1080	SULPHUR HEXAFLUORIDE	70	1,06
1080	SULPHUR HEXAFLUORIDE	140	1,34
1080	SULPHUR HEXAFLUORIDE	160	1,38
1962	ETHYLENE	300	0,38
1973	CHLORODIFLUOROMETHANE AND CHLOROPENTAFLUOROETHANE MIXTURE with fixed boiling point, with approximately 49% chlorodifluoromethane (REFRIGERANT GAS R 502)	31	1,01
1976	OCTAFLUOROCYCLOBUTANE (RC 318)	11	1,32
1982	TETRAFLUOROMETHANE (R 14)	200	0,71
1982	TETRAFLUOROMETHANE (R 14)	300	0,90
1984	TRIFLUOROMETHANE (R 23)	190	0,88
1984	TRIFLUOROMETHANE (R 23)	250	0,96
2035	1,1,1-TRIFLUOROETHANE (R 143A)	35	0,73
2036	XENON	130	1,28
2193	HEXAFLUOROETHANE (R 116)	200	1,13
2196	TUNGSTEN HEXAFLUORIDE	10	3,08
2198	PHOSPHORUS PENTAFLUORIDE	300	1,25
2424	OCTAFLUOROPROPANE (R 218)	25	1,04
2454	METHYL FLUORIDE (R 41)	300	0,63
2599	CHLOROTRIFLUOROMETHANE AND TRIFLUOROMETHANE AZEOTROPIC MIXTURE with approximately 60% chlorotrifluoromethane (REFRIGERANT GAS R 503)	31	0,12
2599	CHLOROTRIFLUOROMETHANE AND TRIFLUOROMETHANE AZEOTROPIC MIXTURE with approximately 60% chlorotrifluoromethane (REFRIGERANT GAS R 503)	42	0,17
2599	CHLOROTRIFLUOROMETHANE AND TRIFLUOROMETHANE AZEOTROPIC MIXTURE with approximately 60% chlorotrifluoromethane (REFRIGERANT GAS R 503)	100	0,64

In Table 2, amend the values in columns "Test pressure" and "Filling ratio" as follows:

UN No.	Name and description	Test pressure, bar		Filling ratio
		existing	amended	
1005	AMMONIA, ANHYDROUS	33	29	0,54
1018	CHLORODIFLUOROMETHANE (R 22)	29	27	unchanged
1021	1-CHLORO-1,2,2,2-TETRAFLUOROETHANE (R 124)	12	11	unchanged
1027	CYCLOPROPANE	20	18	0,55
1028	DICHLORODIFLUOROMETHANE (R 12)	18	16	unchanged
1030	1,1-DIFLUOROETHANE (R 152A)	18	16	unchanged
1053	HYDROGEN SULPHIDE	55	48	unchanged
1077	PROPYLENE	30	27	unchanged
1079	SULPHUR DIOXIDE	14	12	unchanged
1978	PROPANE	25	23	0,43
2204	CARBONYL SULPHIDE	26	30	0,87
2676	STIBINE	20	200	0,49
3159	1,1,1,2-TETRAFLUOROETHANE (R 134A)	22	18	1,05
3220	PENTAFLUOROETHANE (R 125)	36	35	0,87
3296	HEPTAFLUOROPROPANE (R 227)	15	13	1,21
3338	REFRIGERANT GAS R 407A (Difluoromethane, pentafluoroethane, and 1,1,1,2-tetrafluoroethane zeotropic mixture with approximately 20% difluoromethane and 40% pentafluoroethane)	36	32	unchanged
3339	REFRIGERANT GAS R 407B (Difluoromethane, pentafluoroethane, and 1,1,1,2-tetrafluoroethane zeotropic mixture with approximately 10% difluoromethane and 70% pentafluoroethane)	38	33	unchanged
3340	REFRIGERANT GAS R 407C (Difluoromethane, pentafluoroethane, and 1,1,1,2-tetrafluoroethane zeotropic mixture with approximately 23% difluoromethane and 25% pentafluoroethane)	35	30	unchanged

P 203 In paragraph (9), replace "6.2.1.6" with:

"6.2.1.6 and 6.2.3.5 respectively".

[Ref. doc.: ECE/TRANS/WP.15/AC.1/2007/18 + INF.32 JM 03/07 + INF.21 JM 09/97]

P 400 In the first sentence, delete:

"(see also the Table in 4.1.4.4)".

[Ref. doc.: TRANS/WP.15/AC.1/2006/15 + TRANS/WP.15/AC.1/2006/30 + INF.35 JM 09/06 as amended]

P 401

In the first sentence, delete:

"(see also the Table in 4.1.4.4)".

[Ref. doc.: TRANS/WP.15/AC.1/2006/15 + TRANS/WP.15/AC.1/2006/30 + INF.35 JM 09/06 as amended]

At the end, add the following new special packing provision specific to RID and ADR:

"Special packing provision specific to RID and ADR	
RR 7	For UN Nos. 1183, 1242, 1295 and 2988, the pressure receptacles shall however be subjected to the tests every five years."

[Ref. doc.: TRANS/WP.15/AC.1/2006/15 + TRANS/WP.15/AC.1/2006/30 + INF.35 JM 09/06 as amended]

P 402

In the first sentence, delete:

"(see also the Table in 4.1.4.4)".

[Ref. doc.: TRANS/WP.15/AC.1/2006/15 + TRANS/WP.15/AC.1/2006/30 + INF.35 JM 09/06 as amended]

Add the following new special packing provisions specific to RID and ADR:

"RR 7	For UN No. 3129, the pressure receptacles shall however be subjected to the tests every five years.
RR 8	For UN Nos. 1389, 1391, 1411, 1421, 1928, 3129, 3130 and 3148, the pressure receptacles shall however be subjected to an initial test and to periodic tests at a pressure of not less than 1 MPa (10 bar)."

[Ref. doc.: TRANS/WP.15/AC.1/2006/15 + TRANS/WP.15/AC.1/2006/30 + INF.35 JM 09/06 as amended]

P 406

Add the following new special packing provision:

"PP 48	For UN No. 3474, metal packagings shall not be used."
---------------	---

P 601

In (2), delete:

"or additionally, for UN No 1744 only, in polyvinylidene fluoride (PVDF) inner packagings,".

Amend **PP 82** to read as follows:

"PP 82 (Deleted)".

Amend special packing provision specific to RID and ADR RR3 to read as follows:

"RR 3 (Deleted)".

[Ref. doc.: TRANS/WP.15/AC.1/2006/15 + TRANS/WP.15/AC.1/2006/30 + INF.35 JM 09/06 as amended]

Add the following new special packing provisions specific to RID and ADR:

"RR 7	For UN No. 1251, the pressure receptacles shall however be subjected to the tests every five years.
RR 10	UN No. 1614, when completely absorbed by an inert porous material, shall be packed in metal receptacles of a capacity of not more than 7.5 litres, placed in wooden cases in such a manner that they cannot come into contact with one another. The receptacles shall be entirely filled with the porous material which shall not shake down or form dangerous spaces even after prolonged use or under impact, even at temperatures of up to 50 °C."

[Ref. doc.: TRANS/WP.15/AC.1/2006/15 + TRANS/WP.15/AC.1/2006/30 + INF.35 JM 09/06 as amended]

P 620 Amend paragraph (b) to read as follows:

"(b) A rigid outer packaging. The smallest external dimension shall be not less than 100 mm."

In additional requirement 2 (b), replace "6.3.1.1" with:

"6.3.3".

Insert the following new additional requirement 4:

"4. Alternative packagings for the carriage of animal material may be authorized by the competent authority of the country of origin* in accordance with the provisions of 4.1.8.7.

* If the country of origin is not a COTIF Member State, the competent authority of the first COTIF Member State reached by the consignment."

P 621 In the second sentence, delete:

"and the special provisions of 4.1.8".

P 650 In paragraph (6), replace "in 6.3.2.5 as specified in 6.3.2.2 to 6.3.2.4" with:

"in 6.3.5.3 as specified in 6.3.5.2".

In paragraph (9) (a), add the following new Note:

"NOTE: If dry ice is used, there are no requirements to be met (see 2.2.9.1.14). If liquid nitrogen is used, it is sufficient to comply with Chapter 3.3, special provision 593."

[Ref. doc.: ECE/TRANS/WP.15/AC.1/2007/9 + INF.61 JM 09/07]

Insert the following new additional requirement at the end:

"Additional requirement

Alternative packagings for the carriage of animal material may be authorized by the competent authority of the country of origin* in accordance with the provisions of 4.1.8.7.

* If the country of origin is not a COTIF Member State, the competent authority of the first COTIF Member State reached by the consignment."

P 801 After "provisions of 4.1.1", insert:

", except 4.1.1.3,".

P 903 In the first row after the packing instruction number, replace "and 3091" with:

", 3091, 3480 and 3481".

Before "cells and batteries", delete:

"lithium" (twice).

P 903a In the first row after the packing instruction number, replace "and 3091" with:

", 3091, 3480 and 3481".

In the first indent after "provisions of 4.1.1", insert:

", except 4.1.1.3,".

P 903b Amend to read as follows:

"P 903b	PACKING INSTRUCTION	P 903b
	This instruction applies to used cells and batteries of UN Nos. 3090, 3091, 3480 and 3481.	
	Used lithium cells and batteries with a gross mass of not more than 500 g each, collected for disposal, may be carried together with other used non-lithium batteries or alone without being individually protected, under the following conditions: (1) In 1H2 drums or 4H2 boxes conforming to the packing group II performance level for solids; (2) In 1A2 drums or 4A boxes fitted with a polyethylene bag and conforming to the packing group II performance level for solids. The polyethylene bag – shall have an impact resistance of at least 480 grams in both parallel and perpendicular planes with respect to the length of the bag; – shall have a minimum of 500 microns of thickness with an electrical resistivity of more than 10 Mohms and a water absorption rate over 24 hours at 25 °C lower than 0.01%; – shall be closed and	

<p>– may only be used once;</p> <p>(3) In collecting trays with a gross mass of less than 30 kg made from non-conducting material meeting the general conditions of 4.1.1.1, 4.1.1.2 and 4.1.1.5 to 4.1.1.8.</p>
<p>Additional requirements</p> <p>The empty space in the packaging shall be filled with cushioning material. The cushioning material may be dispensed with when the packaging is entirely fitted with a polyethylene bag and the bag is closed.</p> <p>Hermetically sealed packagings shall be fitted with a venting device according to 4.1.1.8. The venting device shall be so designed that an overpressure caused by gases does not exceed 10 kPa."</p>

[Ref. doc.: ECE/TRANS/WP.15/AC.1/2007/21 + INF.48/Rev.1 JM 03/07]

Insert the following new packing instructions **P 004**, **P 010** and **P 804**:

"P 004	PACKING INSTRUCTION	P 004
This instruction applies to UN Nos. 3473, 3476, 3477, 3478 and 3479.		
The following packagings are authorized provided the general provisions of 4.1.1.1, 4.1.1.2, 4.1.1.3, 4.1.1.6 and 4.1.3 are met:		
<p>(1) For fuel cell cartridges, packagings conforming to the packing group II performance level; and</p> <p>(2) For fuel cell cartridges contained in equipment or packed with equipment, strong outer packagings. Large robust equipment (see 4.1.3.8) containing fuel cell cartridges may be carried unpackaged. When fuel cell cartridges are packed with equipment, they shall be packed in inner packagings or placed in the outer packaging with cushioning material or divider(s) so that the fuel cell cartridges are protected against damage that may be caused by the movement or placement of the contents within the outer packaging. Fuel cell cartridges which are installed in equipment shall be protected against short circuit and the entire system shall be protected against inadvertent operation.</p>		

P 010	PACKING INSTRUCTION	P 010
The following packagings are authorized, provided that the general provisions of 4.1.1 and 4.1.3 are met:		
Combination packagings		
Inner packagings	Outer packagings	Maximum net mass (see 4.1.3.3)
Glass 1 l Steel 40 l	<p>Drums steel (1A2) plastics (1H2) plywood (1D) fibre (1G)</p>	<p>400 kg 400 kg 400 kg 400 kg</p>
	<p>Boxes steel (4A) natural wood (4C1, 4C2) plywood (4D)</p>	<p>400 kg 400 kg 400 kg</p>

	reconstituted wood (4F) fibreboard (4G) expanded plastics (4H1) solid plastics (4H2)	400 kg 400 kg 60 kg 400 kg
Single packagings		Maximum capacity (see 4.1.3.3)
Drums steel, non-removable head (1A1)		450 l
Jerricans steel, non-removable head (3A1)		60 l
Composite packagings plastics receptacle in steel drums (6HA1)		250 l

P 804	PACKING INSTRUCTION	P 804
This instruction applies to UN 1744.		
<p>The following packagings are authorized provided the general provisions of 4.1.1 and 4.1.3 are met and the packagings are hermetically sealed:</p> <p>(1) Combination packagings with a maximum gross mass of 25 kg, consisting of</p> <ul style="list-style-type: none"> – one or more glass inner packaging(s) with a maximum capacity of 1.3 litres each and filled to not more than 90% of their capacity; the closure(s) of which shall be physically held in place by any means capable of preventing back-off or loosening by impact or vibration during carriage, individually placed in – metal or rigid plastics receptacles together with cushioning and absorbent material sufficient to absorb the entire contents of the glass inner packaging(s), further packed in – 1A2, 1B2, 1N2, 1H2, 1D, 1G, 4A, 4B, 4C1, 4C2, 4D, 4F, 4G or 4H2 outer packagings. <p>(2) Combination packagings consisting of metal or polyvinylidene fluoride (PVDF) inner packagings, not exceeding 5 litres in capacity individually packed with absorbent material sufficient to absorb the contents and inert cushioning material in 1A2, 1B2, 1N2, 1H2, 1D, 1G, 4A, 4B, 4C1, 4C2, 4D, 4F, 4G or 4H2 outer packagings with a maximum gross mass of 75 kg. Inner packagings shall not be filled to more than 90% of their capacity. The closure of each inner packaging shall be physically held in place by any means capable of preventing back-off or loosening of the closure by impact or vibration during carriage;</p> <p>(3) Packagings consisting of:</p> <p style="padding-left: 20px;">Outer packagings:</p> <p style="padding-left: 40px;">Steel or plastic drums, removable head (1A2 or 1H2) tested in accordance with the test requirements in 6.1.5 at a mass corresponding to the mass of the assembled package either as a packaging intended to contain inner packagings, or as a single packaging intended to contain solids or liquids, and marked accordingly;</p> <p style="padding-left: 20px;">Inner packagings:</p>		

Drums and composite packagings (1A1, 1B1, 1N1, 1H1 or 6HA1) meeting the requirements of Chapter 6.1 for single packagings, subject to the following conditions:

- (a) The hydraulic pressure test shall be conducted at a pressure of at least 300 kPa (3 bar) (gauge pressure);
 - (b) The design and production leakproofness tests shall be conducted at a test pressure of 30 kPa (0.3 bar);
 - (c) They shall be isolated from the outer drum by the use of inert shock-mitigating cushioning material which surrounds the inner packaging on all sides;
 - (d) Their capacity shall not exceed 125 litres;
 - (e) Closures shall be of a screw type that are:
 - (i) Physically held in place by any means capable of preventing back-off or loosening of the closure by impact or vibration during carriage;
 - (ii) Provided with a cap seal;
 - (f) The outer and inner packagings shall be subjected periodically to an internal inspection and leakproofness test according to (b) at intervals of not more than two and a half years; and
 - (g) The outer and inner packagings shall bear in clearly legible and durable characters:
 - (i) the date (month, year) of the initial test and the latest periodic test and inspection of the inner packaging; and
 - (ii) the name or authorized symbol of the expert performing the tests and inspections;
- (4) Pressure receptacles, provided that the general provisions of 4.1.3.6 are met.
- (a) They shall be subjected to an initial test and periodic tests every 10 years at a pressure of not less than 1 MPa (10 bar) (gauge pressure);
 - (b) They shall be subjected periodically to an internal inspection and leakproofness test at intervals of not more than two and a half years;
 - (c) They may not be equipped with any pressure relief device;
 - (d) Each pressure receptacle shall be closed with a plug or valve(s) fitted with a secondary closure device; and
 - (e) The materials of construction for the pressure receptacle, valves, plugs, outlet caps, luting and gaskets shall be compatible with each other and with the contents."

[Ref. doc.: INF.34 JM 09/07 + INF.48 JM 09/07]

4.1.4.2

**IBC 01,
IBC 02 and
IBC 03**

Delete the additional requirement.

IBC 02

Add a new special packing provision to read as follows:

"B 15	For UN 2031 with more than 55% nitric acid, the permitted use of rigid plastics IBCs and of composite IBCs with a rigid plastics inner receptacle shall be two years from their date of manufacture."
--------------	---

IBC 99

Before "by the competent authority", insert:

"for these goods".

Add the following new sentence at the end:

"A copy of the competent authority approval shall accompany each consignment or the transport document shall include an indication that the packaging was approved by the competent authority".

IBC 520

For UN 3109, in the entry for "tert-Butyl peroxy-3,5,5-trimethylhexanoate, not more than 32% in diluent type A" (third entry), replace "32%" with:

"37%".

Insert the following new entries:

UN No.	Organic peroxide	Type of IBC	Maximum quantity (litres/kg)
3109	tert-BUTYL PEROXYBENZOATE, not more than 32% in diluent type A	31A	1250
3109	1,1-DI-(tert-BUTYLPEROXY)CYCLOHEXANE, not more than 37% in diluent type A	31A	1250

IBC 620

In the second sentence, delete:

"and the special provisions of 4.1.8".

4.1.4.3

LP 99

Before "by the competent authority", insert:

"for these goods".

At the end, delete:

"(see 4.1.3.7)".

Add the following new sentence at the end:

"A copy of the competent authority approval shall accompany each consignment or the transport document shall include an indication that the packaging was approved by the competent authority."

- LP 621** In the second sentence, delete:
"and the special provisions of 4.1.8".
- 4.1.4.4** Delete.
[Ref. doc.: TRANS/WP.15/AC.1/2006/15 + TRANS/WP.15/AC.1/2006/30 + INF.35 JM 09/06 as amended]
- 4.1.6** Delete the Note.
[Ref. doc.: TRANS/WP.15/AC.1/2006/15 + TRANS/WP.15/AC.1/2006/30 + INF.35 JM 09/06 as amended]
- 4.1.6.2** Delete the second and third sentences ("Pressure receptacles for UN 1001 acetylene ... compatible with the pressure receptacles.").
- 4.1.6.4** Replace "6.2.1.6" with "6.2.1.6 and 6.2.3.5 respectively".
[Ref. doc.: ECE/TRANS/WP.15/AC.1/2007/18 + INF.32 JM 03/07 + INF.21 JM 09/07]
- 4.1.6.8** Delete paragraph (d) and renumber (e) and (f) accordingly.
Add the following new sentence to the new paragraph (e):
"For UN pressure receptacles the packaging as prepared for carriage shall be capable of meeting the drop test specified in 6.1.5.3 at the packing group I performance level."
[Ref. doc.: ECE/TRANS/WP.15/AC.1/2007/18]
- 4.1.6.10** Replace "6.2.1.6" with:
"6.2.1.6 and 6.2.3.5 respectively".
[Ref. doc.: ECE/TRANS/WP.15/AC.1/2007/18 + INF.32 JM 03/07 + INF.21 JM 09/07]
- 4.1.6.14** In the table, delete the reference to standard "EN 1795:1997".
Replace "ISO 11621:1997" with:
"ISO 11621:2005".
[Ref. doc.: INF.39 JM 03/06]
In the Table, replace "EN 962:1996/A2:2000" with:
"EN 962:1996 + A2:2000".
[Ref. doc.: INF.44 JM 03/07]

- 4.1.8.2** Replace "liquids shall be filled into packagings, including IBCs, which" with:
"liquids shall only be filled into packagings which".
- 4.1.8.3** In the first sentence, delete:
"For UN No. 2814 and UN No. 2900,".
In the second sentence, delete:
"and assignment to UN Nos 2814 or 2900".
- 4.1.8.4** Delete:
"thoroughly".
After "sterilized", add:
"to nullify any hazard".
- 4.1.8.5** Replace with the text of existing 6.3.2.8.
Add the following new sub-sections:
- "4.1.8.6** Paragraphs 4.1.8.1 to 4.1.8.5 only apply to infectious substances of Category A (UN Nos. 2814 and 2900). They do not apply to UN No. 3373 BIOLOGICAL SUBSTANCE, CATEGORY B (see packing instruction P650 of 4.1.4.1), nor to UN No. 3291 CLINICAL WASTE, UNSPECIFIED, N.O.S. or (BIO) MEDICAL WASTE, N.O.S. or REGULATED MEDICAL WASTE, N.O.S.
- 4.1.8.7** For the carriage of animal material, packagings or IBCs not specifically authorized in the applicable packing instruction shall not be used for the carriage of a substance or article unless specifically approved by the competent authority of the country of origin* and provided:
- (a) The alternative packaging complies with the general requirements of this Part;
 - (b) When the packing instruction indicated in column (8) of Table A of Chapter 3.2 so specifies, the alternative packaging meets the requirements of Part 6;
 - (c) The competent authority of the country of origin* determines that the alternative packaging provides at least the same level of safety as if the substance were packed in accordance with a method specified in the particular packing instruction indicated in column (8) of Table A of Chapter 3.2; and
 - (d) A copy of the competent authority approval accompanies each consignment or the transport document includes an indication that alternative packaging was approved by the competent authority.
- * If the country of origin is not a COTIF Member State, the competent authority of the first COTIF Member State reached by the consignment."
- 4.1.9.1.1** Replace "2.2.7.7.1" with:
"2.2.7.2.2, 2.2.7.2.4.1, 2.2.7.2.4.4, 2.2.7.2.4.5, 2.2.7.2.4.6, special provision 336 of Chapter 3.3 and 4.1.9.3".

[Consequential amendment; ref. doc.: INF.18 JM 09/07]

Add at the end:

"The types of packages for radioactive materials covered by RID, are:

- (a) Excepted package (see 1.7.1.5);
- (b) Industrial package Type 1 (Type IP-1 package);
- (c) Industrial package Type 2 (Type IP-2 package);
- (d) Industrial package Type 3 (Type IP-3 package);
- (e) Type A package;
- (f) Type B(U) package;
- (g) Type B(M) package;
- (h) Type C package.

Packages containing fissile material or uranium hexafluoride are subject to additional requirements."

4.1.9.1.3 Amend the first sentence to read as follows:

"A package, other than an excepted package, shall not contain any items other than those that are necessary for the use of the radioactive material."

[Ref. doc.: ECE/TRANS/WP.15/AC.1/2007/58]

Insert the following new paragraphs 4.1.9.1.6 to 4.1.9.1.11:

"4.1.9.1.6 Before the first shipment of any package, the following requirements shall be fulfilled:

- (a) If the design pressure of the containment system exceeds 35 kPa (gauge), it shall be ensured that the containment system of each package conforms to the approved design requirements relating to the capability of that system to maintain its integrity under that pressure;
- (b) For each Type B(U), Type B(M) and Type C package and for each package containing fissile material, it shall be ensured that the effectiveness of its shielding and containment and, where necessary, the heat transfer characteristics and the effectiveness of the confinement system, are within the limits applicable to or specified for the approved design;
- (c) For packages containing fissile material, where, in order to comply with the requirements of 6.4.11.1, neutron poisons are specifically included as components of the package, checks shall be performed to confirm the presence and distribution of those neutron poisons.

4.1.9.1.7 Before each shipment of any package, the following requirements shall be fulfilled:

- (a) For any package it shall be ensured that all the requirements specified in the relevant provisions of RID have been satisfied;

- (b) It shall be ensured that lifting attachments which do not meet the requirements of 6.4.2.2 have been removed or otherwise rendered incapable of being used for lifting the package, in accordance with 6.4.2.3;
- (c) For each package requiring competent authority approval, it shall be ensured that all the requirements specified in the approval certificates have been satisfied;
- (d) Each Type B(U), Type B(M) and Type C package shall be held until equilibrium conditions have been approached closely enough to demonstrate compliance with the requirements for temperature and pressure unless an exemption from these requirements has received unilateral approval;
- (e) For each Type B(U), Type B(M) and Type C package, it shall be ensured by inspection and/or appropriate tests that all closures, valves, and other openings of the containment system through which the radioactive contents might escape are properly closed and, where appropriate, sealed in the manner for which the demonstrations of compliance with the requirements of 6.4.8.8 and 6.4.10.3 were made;
- (f) For each special form radioactive material, it shall be ensured that all the requirements specified in the approval certificate and the relevant provisions of RID have been satisfied;
- (g) For packages containing fissile material the measurement specified in 6.4.11.4 (b) and the tests to demonstrate closure of each package as specified in 6.4.11.7 shall be performed where applicable;
- (h) For each low dispersible radioactive material, it shall be ensured that all the requirements specified in the approval certificate and the relevant provisions of RID have been satisfied.

4.1.9.1.8 The consignor shall also have a copy of any instructions with regard to the proper closing of the package and any preparation for shipment before making any shipment under the terms of the certificates.

4.1.9.1.9 Except for consignments under exclusive use, the transport index of any package or overpack shall not exceed 10, nor shall the criticality safety index of any package or overpack exceed 50.

4.1.9.1.10 Except for packages or overpacks carried under exclusive use under the conditions specified in 7.5.11, CW 33 (3.5) (a), the maximum radiation level at any point on any external surface of a package or overpack shall not exceed 2 mSv/h.

4.1.9.1.11 The maximum radiation level at any point on any external surface of a package or overpack under exclusive use shall not exceed 10 mSv/h."

4.1.9.2.3 In (b), replace "2.2.7.2" with:

"2.2.7.1.2".

In (c), replace "2.2.7.5 (a) (i)" with:

"2.2.7.2.3.2 (a) (i)".

[Consequential amendments]

Insert a new sub-section 4.1.9.3 to read as follows:

"4.1.9.3 Packages containing fissile material

Unless not classified as fissile in accordance with 2.2.7.2.3.5, packages containing fissile material shall not contain:

- (a) A mass of fissile material different from that authorized for the package design;
- (b) Any radionuclide or fissile material different from those authorized for the package design; or
- (c) Contents in a form or physical or chemical state, or in a spatial arrangement, different from those authorized for the package design;

as specified in their certificates of approval where appropriate."

**4.1.10.4
MP 24**

At the end of the Table, insert a new row and a new line for UN 0505 with the same indications as for UN 0312.

At the end of the Table, insert two new rows and two new lines for UN Nos. 0506 and 0507 with the same indications as for UN 0405.

[Consequential amendment]

Chapter 4.2

4.2.5.3

TP 12 Amend to read as follows:

"TP 12 (Deleted)".

Add the following new special provision:

"TP 35 Portable tank instruction T 14 prescribed in RID applicable up to 31 December 2008 may continue to be applied until 31 December 2014."

Chapter 4.3

4.3.2.2.4 Amend to read as follows:

"4.3.2.2.4 (Reserved)

Shells intended for the carriage of substances in the liquid state or liquefied gases or refrigerated liquefied gases, which are not divided by partitions or surge plates into sections of not more than 7 500 litres capacity, shall be filled to not less than 80% or not more than 20% of their capacity.

This provision is not applicable to:

- liquids with a kinematic viscosity at 20 °C of at least 2 680 mm²/s;

- molten substances with a kinematic viscosity at the temperature of filling of at least 2 680 mm²/s;
- UN 1963 HELIUM, REFRIGERATED, LIQUID and UN 1966 HYDROGEN, REFRIGERATED, LIQUID."

[Ref. doc.: ECE/TRANS/WP.15/AC.1/2007/8 + INF.34 JM 03/07 + INF.49 JM 03/07 + INF.29 JM 09/07 + INF.52 JM 09/07]

4.3.3.2.5 In column "Classification code" of the Table, for UN 1017, replace "2 TC" with:
"2 TOC".

[Consequential amendment]

4.3.3.4.1 (a) Amend the second sentence to read as follows:

"Tank-wagons for multiple use shall especially be checked to ensure that the correct folding panels are visible and securely fixed by the means referred to in 6.8.3.5.7 on both sides of the wagon."

[Ref. doc.: OTIF/RID/CE/2006/6 as amended + OTIF/RID/CE/2006-A]

PART 5

Chapter 5.1

5.1.2.1 (a) Amend the text after (ii) to read as follows:

"unless the UN numbers and the labels representative of all dangerous goods contained in the overpack are visible, except as required in 5.2.2.1.11. If the same UN number or the same label ... (remainder unchanged)".

[Ref. doc.: ECE/TRANS/WP.15/AC.1/2007/28, Alternative 2]

5.1.3.2 Replace "Tanks and IBCs" with:

"Packagings, including IBCs, and tanks".

5.1.5.1 Delete.

5.1.5.2 to 5.1.5.3.3 become **5.1.5.1 to 5.1.5.2.3**.

[Consequential amendments see under 5.1.5.1.1, 5.1.5.2.1, 5.1.5.4. 6.4.23.14 (h), 6.4.22.2, 6.4.22.3 und 6.4.23.2 (c).]

5.1.5.1.1 (current 5.1.5.2.1) Replace "(5.1.5.2.2 and 5.1.5.2.3)" with:

"(5.1.5.1.2 and 5.1.5.1.3)".

[Consequential amendment in relation with the deletion of 5.1.5.1]

Replace "(5.1.5.2.4)" with:

"(5.1.5.1.4)".

[Consequential amendment in relation with the deletion of 5.1.5.1]

5.1.5.2.1 (current 5.1.5.3.1) In paragraph (c), replace "(see 5.1.5.2.2)" with:

"(see 5.1.5.1.2)".

[Consequential amendment in relation with the deletion of 5.1.5.1]

5.1.5.2.2 (current 5.1.5.3.2) Delete the second sentence.

Insert a new sub-section to read as follows:

"5.1.5.3 Determination of transport index (TI) and criticality safety index (CSI)

5.1.5.3.1 The transport index (TI) for a package, overpack or container, or for unpackaged LSA-I or SCO-I, shall be the number derived in accordance with the following procedure:

- (a) Determine the maximum radiation level in units of millisieverts per hour (mSv/h) at a distance of 1 m from the external surfaces of the package, overpack, container, or unpackaged LSA-I and SCO-I. The value determined shall be multiplied by 100 and the resulting number is the transport index.

For uranium and thorium ores and their concentrates, the maximum radiation level at any point 1 m from the external surface of the load may be taken as:

0.4 mSv/h for ores and physical concentrates of uranium and thorium;

0.3 mSv/h for chemical concentrates of thorium;

0.02 mSv/h for chemical concentrates of uranium, other than uranium hexafluoride;

- (b) For tanks, containers and unpackaged LSA-I and SCO-I, the value determined in step (a) above shall be multiplied by the appropriate factor from Table 5.1.5.3.1;

- (c) The value obtained in steps (a) and (b) above shall be rounded up to the first decimal place (e.g. 1.13 becomes 1.2), except that a value of 0.05 or less may be considered as zero.

Table 5.1.5.3.1: Multiplication factors for tanks, containers and unpackaged LSA-I and SCO-I

Size of load ^(a)	Multiplication factor
size of load $\leq 1 \text{ m}^2$	1
$1 \text{ m}^2 < \text{size of load} \leq 5 \text{ m}^2$	2
$5 \text{ m}^2 < \text{size of load} \leq 20 \text{ m}^2$	3
$20 \text{ m}^2 < \text{size of load}$	10

^(a) Largest cross-sectional area of the load being measured.

- 5.1.5.3.2** The transport index for each overpack, container or wagon shall be determined as either the sum of the TIs of all the packages contained, or by direct measurement of radiation level, except in the case of non-rigid overpacks for which the transport index shall be determined only as the sum of the TIs of all the packages.
- 5.1.5.3.3** The criticality safety index for each overpack or container shall be determined as the sum of the CSIs of all the packages contained. The same procedure shall be followed for determining the total sum of the CSIs in a consignment or aboard a wagon.
- 5.1.5.3.4** Packages and overpacks shall be assigned to either category I-WHITE, II-YELLOW or III-YELLOW in accordance with the conditions specified in Table 5.1.5.3.4 and with the following requirements:
- (a) For a package or overpack, both the transport index and the surface radiation level conditions shall be taken into account in determining which is the appropriate category. Where the transport index satisfies the condition for one category but the surface radiation level satisfies the condition for a different category, the package or overpack shall be assigned to the higher category. For this purpose, category I-WHITE shall be regarded as the lowest category;
 - (b) The transport index shall be determined following the procedures specified in 5.1.5.3.1 and 5.1.5.3.2;
 - (c) If the surface radiation level is greater than 2 mSv/h, the package or overpack shall be carried under exclusive use and under the provisions of 7.5.11, CW 33 (3.5) (a), as appropriate;
 - (d) A package carried under a special arrangement shall be assigned to category III-YELLOW except when otherwise specified in the competent authority approval certificate of the country of origin of design (see 2.2.7.2.4.6);
 - (e) An overpack which contains packages carried under special arrangement shall be assigned to category III-YELLOW except when otherwise specified in the competent authority approval certificate of the country of origin of design (see 2.2.7.2.4.6).

Table 5.1.5.3.4: Categories of packages and overpacks

Conditions		Category
Transport index (TI)	Maximum radiation level at any point on external surface	
0 ^(a)	Not more than 0.005 mSv/h	I-WHITE
More than 0 but not more than 1 ^(a)	More than 0.005 mSv/h but not more than 0.5 mSv/h	II-YELLOW
More than 1 but not more than 10	More than 0.5 mSv/h but not more than 2 mSv/h	III-YELLOW
More than 10	More than 2 mSv/h but not more than 10 mSv/h	III-YELLOW ^(b)

^(a) If the measured TI is not greater than 0.05, the value quoted may be zero in accordance with 5.1.5.3.1 (c).

^(b) Shall also be carried under exclusive use."

[Consequential amendments see under 3.2.1 column (5) und 5.2.2.1.11.1]

5.1.5.4 In Note 1, replace "(see 5.1.5.2.4 (a))" with:

"(see 5.1.5.1.4 (a))".

In Note 2, replace "(see 5.1.5.2.4 (b))" with:

"(see 5.1.5.1.4 (b))".

In Note 3, replace "(see 5.1.5.2)" with:

"(see 5.1.5.1)".

In the last column of the Table, replace "5.1.5.2.4 (b)", "5.1.5.3.1 (a)" and "5.1.5.2.2" with:

"5.1.5.1.4 (b)" (five times), "5.1.5.2.1 (a)" (nine times) and "5.1.5.1.2" (three times).

[Consequential amendment in relation with the deletion of 5.1.5.1]

Chapter 5.2

5.2.1.6 In Note 1, replace "6.2.1.7":

with "6.2.2.7".

[Ref. doc.: INF.32 JM 03/07]

In Note 2, replace "6.2.1.8" with:

"6.2.2.8".

[Ref. doc.: INF.32 JM 03/07]

Add the following new sub-section:

"5.2.1.8 Special marking provisions for environmentally hazardous substances

5.2.1.8.1 Packages containing environmentally hazardous substances meeting the criteria of 2.2.9.1.10 shall be durably marked with the environmentally hazardous substance mark shown in 5.2.1.8.3, with the exception of single packagings and combination packagings containing inner packagings with:

- contents of 5 l or less for liquids, or
- contents of 5 kg or less for solids.

5.2.1.8.2 The environmentally hazardous substance mark shall be located adjacent to the markings required by 5.2.1.1. The requirements of 5.2.1.2 and 5.2.1.4 shall be met.

5.2.1.8.3 The environmentally hazardous substance mark shall be as shown below. The dimensions shall be 100 mm × 100 mm, except in the case of packages of such dimensions that they can only bear smaller marks.



Symbol (fish and tree): black on white or suitable contrasting background".

[Ref. doc.: ECE/TRANS/WP.15/AC.1/2007/51 Annex 1]

5.2.1.9.2 (a) Delete:

"closed".

5.2.2.1.11.1 In the first sentence, replace "Except as provided for large containers and tanks in accordance with 5.3.1.1.3" with:

"Except when enlarged labels are used in accordance with 5.3.1.1.3".

In the first sentence, replace "(see 2.2.7.8.4)" with:

"(see 5.1.5.3.4)".

[Consequential amendment]

5.2.2.1.11.2 In paragraph (a) (i), replace "2.2.7.7.2.1" with:

"2.2.7.2.2.1".

[Consequential amendment]

In paragraph (d), replace "See 2.2.7.6.1.1 and 2.2.7.6.1.2." with:

"The number determined in accordance with 5.1.5.3.1 and 5.1.5.3.2."

5.2.2.2.1 Add the following new second sentence:

"Corresponding models required for other modes of transport, with minor variations which do not affect the obvious meaning of the label, are also acceptable."

[Ref. doc.: ECE/TRANS/WP.15/AC.1/2007/16 + INF.43 JM 03/07]

5.2.2.2.1.1 Replace "They have a line of the same colour as the symbol, 5 mm inside the edge and running parallel with it." With:

"They shall have a line 5 mm inside the edge and running parallel with it. In the upper half of a label the line shall have the same colour as the symbol and in the lower half it shall have the same colour as the figure in the bottom corner."

[Consequential amendments see under 5.3.1.7.1]

5.2.2.2.1.2 In the first sub-paragraph, replace "ISO 7225:1994" with:

"EN ISO 7225:2005".

In the second sub-paragraph, replace "by ISO 7225" with:

"by ISO 7225:2005".

5.2.2.2.1.3 Amend to read as follows:

"5.2.2.2.1.3 With the exception of labels for Divisions 1.4, 1.5 and 1.6 of Class 1, the upper half of the label shall contain the pictorial symbol and the lower half shall contain:

(a) For Classes 1, 2, 3, 5.1, 5.2, 7, 8 and 9, the class number;

(b) For Classes 4.1, 4.2 and 4.3, the figure "4";

(c) For Classes 6.1 and 6.2, the figure "6".

The labels may include text such as the UN number or words describing the hazard (e.g. "flammable") in accordance with 5.2.2.2.1.5 provided the text does not obscure or detract from the other required label elements."

[Ref. doc.: INF.34 JM 09/07]

5.2.2.2.1.4 Amend to read as follows:

"5.2.2.2.1.4 In addition, except for Divisions 1.4, 1.5 and 1.6, labels for Class 1 shall show in the lower half, above the class number, the division number and the compatibility group letter for the substance or article. Labels for Divisions 1.4, 1.5 and 1.6 shall show in the upper half the division number, and in the lower half the class number and the compatibility group letter."

[Ref. doc.: INF.34 JM 09/07]

5.2.2.2.1.6 At the end of paragraph (b), delete:

"and".

[Consequential amendment]

Insert a new-sub paragraph (c) to read as follows:

"(c) the Class 5.2 label, where the symbol may be shown in white; and".

[Consequential amendments see under 5.2.2.2.1.6 (b) and (c) and 5.2.2.2.2]

Renumber paragraph (c) as (d).

[Consequential amendments]

5.2.2.2.2 Under labels No. 2.1, replace "5.2.2.2.1.6 (c)" with:

"5.2.2.2.1.6 (d)".

[Consequential amendment]

Chapter 5.3

Add a new paragraph 5.3.1.1.6 to read as follows:

5.3.1.1.6 When the placarding is affixed to folding panels, they shall be designed and secured so that they cannot unfold or come loose from the holder during carriage (especially as a result of impacts or unintentional actions)."

[Ref. doc.: ECE/TRANS/WP.15/AC.1/2007/3]

5.3.1.7.1 (a) Amend to read as follows:

"(a) Be not less than 250 mm by 250 mm and have a line 12.5 mm inside the edge and running parallel with it. In the upper half the line shall have the same colour as the symbol and in the lower half it shall have the same colour as the figure in the bottom corner;"

[Consequential amendment in relation with 5.2.2.2.1.1]

5.3.2.1.2 At the beginning of the second sentence, replace "different substances" with:

"different dangerous substances".

At the end of the second sentence, insert after "tank compartments":

"in question".

[Ref. doc.: ECE/TRANS/WP.15/AC.1/2007/27]

5.3.2.1.5 Add a new Note to read as follows:

NOTE: This paragraph need not be applied to the marking with orange coloured plates of closed and sheeted wagons, carrying tanks with a maximum capacity of 3 000 litres."

[Ref. doc.: ECE/TRANS/WP.15/AC.1/2007/47]

5.3.2.2.1 At the end of the first sub-paragraph, add:

"It shall remain affixed irrespective of the orientation of the wagon."

[Ref. doc.: INF.24/Rev.1 JM 03/07]

5.3.2.2.2 Add the following text at the end:

"Interchangeable numbers and letters on plates presenting the hazard identification number and the UN number shall remain in place during carriage and irrespective of the orientation of the wagon."

[Ref. doc.: INF.24/Rev.1 JM 03/07]

Add a new 5.3.2.2.5 to read as follows:

5.3.2.2.5 When the orange-coloured plate or the alternative marking referred to in 5.3.2.2.1 is affixed to folding panels, they shall be designed and secured so that they cannot unfold or come loose from the holder during carriage (especially as a result of impacts or unintentional actions)."

[Ref. doc.: ECE/TRANS/WP.15/AC.1/2007/3]

5.3.2.3.2 Amend the descriptions for identification numbers 423 and X423 to read as follows:

"423 Solid which reacts with water, emitting flammable gases, or flammable solid which reacts with water, emitting flammable gases, or self-heating solid which reacts with water, emitting flammable gases

X423 "Solid which reacts dangerously with water, emitting flammable gases, or flammable solid which reacts dangerously with water, emitting flammable gases, or self-heating solid which reacts dangerously with water, emitting flammable gases³".

[Ref. doc.: TRANS/WP.15/AC.1/2006/29]

Insert after the entry for "43":

"X432 spontaneously flammable (pyrophoric) solid which reacts dangerously with water, emitting flammable gases³".

[Ref. doc.: TRANS/WP.15/AC.1/2006/2 + INF.34 JM 03/06]

"5.3.6 Environmentally hazardous substance mark

When a placard is required to be displayed in accordance with the provisions of section 5.3.1, large containers, MEGCs, tank-containers, portable tanks and wagons containing environmentally hazardous substances meeting the criteria of 2.2.9.1.10 shall be marked with the environmentally hazardous substance mark shown in 5.2.1.8.3, except that the minimum dimensions shall be 250 mm × 250 mm. The other provisions of section 5.3.1 concerning the display of placards shall apply mutatis mutandis to the display of the mark."

[Ref. doc.: ECE/TRANS/WP.15/AC.1/2007/51 Annex 1 + INF.57/Rev.1 JM 09/07]

Chapter 5.4

5.4.1.1.1 (f) Add new Notes 1 and 2 to read as follows:

"NOTE 1: (Reserved)

2: For dangerous goods in machinery or equipment specified in RID, the quantity indicated shall be the total quantity of dangerous goods contained therein in kilograms or litres as appropriate."

[Ref. doc.: ECE/TRANS/WP.15/AC.1/2007/24 as amended]

5.4.1.1.3 Add the following sentence at the end:

"If the provision for waste as set out in 2.1.3.5.5 is applied, the following shall be added to the proper shipping name:

"WASTE IN ACCORDANCE WITH 2.1.3.5.5" (e.g. "UN 3264, CORROSIVE LIQUID, ACIDIC, INORGANIC, N.O.S., 8, II, WASTE IN ACCORDANCE WITH 2.1.3.5.5").

The technical name, as prescribed in Chapter 3.3, special provision 274, need not be added."

[Ref. doc.: INF.21 JM 03/07]

Add a new paragraph 5.4.1.1.6.4 to read as follows:

- 5.4.1.1.6.4** For the carriage of tank-wagons, demountable tanks, battery-wagons, tank-containers and MEGCs under the conditions of 4.3.2.4.4, the following entry shall be included in the transport document:

"CARRIAGE IN ACCORDANCE WITH 4.3.2.4.4."

[Ref. doc.: TRANS/WP.15/AC.1/2006/18 as amended]

- 5.4.1.1.11** Amend to read as follows:

- 5.4.1.1.11** **Special provisions for the carriage of IBCs or portable tanks after the date of expiry of the last periodic test or inspection**

For carriage in accordance with 4.1.2.2 (b), 6.7.2.19.6 (b), 6.7.3.15.6 (b) or 6.7.4.14.6 (b), a statement to this effect shall be included in the transport document, as follows:

"CARRIAGE IN ACCORDANCE WITH 4.1.2.2 (b)",

"CARRIAGE IN ACCORDANCE WITH 6.7.2.19.6 (b)",

"CARRIAGE IN ACCORDANCE WITH 6.7.3.15.6 (b)" or

"CARRIAGE IN ACCORDANCE WITH 6.7.4.14.6 (b)" as appropriate."

Add a new 5.4.1.1.18 to read as follows:

- 5.4.1.1.18** For the carriage of portable tanks under the conditions of 6.7.2.19.6 (b), 6.7.3.15.6 (b) or 6.7.4.14.6 (b), reference to this exemption shall be mentioned in the transport document."

[Ref. doc.: TRANS/WP.15/AC.1/2006/18 + INF.34 JM 09/06 as amended]

- 5.4.1.4.2** Amend footnote 6 to read as follows:

⁶ If used, the relevant recommendations of the UNECE United Nations Centre for Trade Facilitation and Electronic Business (UN/CEFACT) may be consulted, in particular Recommendation No. 1 (United Nations Layout Key for Trade Documents) (ECE/TRADE/137, edition 81.3), UN Layout Key for Trade Documents – Guidelines for Applications (ECE/TRADE/270, edition 2002), Recommendation No. 11 (Documentary Aspects of the International Transport of Dangerous Goods) (ECE/TRADE/204, edition 96.1 – currently under revision) and Recommendation No. 22 (Layout Key for Standard Consignment Instructions) (ECE/TRADE/168, edition 1989). Refer also to the UN/CEFACT Summary of Trade Facilitation Recommendations (ECE/TRADE/346, edition 2006) and the United Nations Trade Data Elements Directory (UNTDDED) (ECE/TRADE/362, edition 2005)."

5.4.2 In footnote 8, add the following new sentence at the end of 5.4.2.2:

"Facsimile signatures are acceptable where applicable laws and regulations recognize the legal validity of facsimile signatures."

In footnote 8, add:

"5.4.2.3 If the dangerous goods documentation is presented to the carrier by means of electronic data processing (EDP) or electronic data interchange (EDI) transmission techniques, the signature(s) may be replaced by the name(s) (in capitals) of the person authorized to sign."

Chapter 5.5

5.5.2.2 At the end, add:

"The warning sign, as required by this sub-section, shall remain on the wagon, container or tank until the following provisions are met:

- (a) The fumigated wagon, container or tank has been ventilated to remove harmful concentrations of fumigant gas; and
- (b) The fumigated goods or materials have been unloaded."

5.5.2.3 In the Fumigation warning sign before "DO NOT ENTER", insert:

"VENTILATED ON [date *]".

PART 6

Chapter 6.1

6.1.1.4 At the end, add a new note to read as follows:

"NOTE: ISO 16106:2006 "Packaging – Transport packages for dangerous goods – Dangerous goods packagings, intermediate bulk containers (IBCs) and large packagings – Guidelines for the application of ISO 9001" provides acceptable guidance on procedures which may be followed."

6.1.2.6 Insert the new following note after the list:

"NOTE: Plastics materials, is taken to include other polymeric materials such as rubber."

6.1.3.1 In paragraph (a) (i), replace the first sentence after the symbol with:

"This symbol shall not be used for any purpose other than certifying that a packaging complies with the relevant requirements in Chapter 6.1, 6.2, 6.3, 6.5 or 6.6. This symbol shall not be used for packagings which comply with the simplified conditions of 6.1.1.3, 6.1.5.3.1 (e), 6.1.5.3.5 (c), 6.1.5.4, 6.1.5.5.1 and 6.1.5.6 (see also (ii) below). For embossed metal packagings, the capital letters "UN" may be applied instead of the symbol;"

[Ref. doc.: ECE/TRANS/WP.15/AC.1/2007/32]

Amend paragraph (a) (ii) to read as follows:

"The symbol "RID/ADR" for composite packagings (glass, porcelain or stoneware) and light gauge metal packagings conforming to simplified conditions (see 6.1.1.3, 6.1.5.3.1 (e), 6.1.5.3.5 (c), 6.1.5.4, 6.1.5.5.1 and 6.1.5.6).

NOTE: Packagings bearing this symbol are approved for rail, road and inland waterways transport operations which are subject to the provisions of RID, ADR and ADN respectively. They are not necessarily accepted for carriage by other modes of transport or for transport operations by road, rail or inland waterways which are governed by other regulations."

[Ref. doc.: ECE/TRANS/WP.15/AC.1/2007/32 as amended]

6.1.5.1.1 Replace "and approved by the competent authority" with:

"by the competent authority allowing the allocation of the mark and shall be approved by this competent authority".

6.1.5.1.2 Replace the first sentence with:

"Each packaging design type shall successfully pass the tests prescribed in this Chapter before being used."

6.1.5.3.4 Amend to read as follows:

"6.1.5.3.4 Target

The target shall be a non-resilient and horizontal surface and shall be:

- Integral and massive enough to be immovable;
- Flat with a surface kept free from local defects capable of influencing the test results;
- Rigid enough to be non-deformable under test conditions and not liable to become damaged by the tests; and
- Sufficiently large to ensure that the test package falls entirely upon the surface."

Chapter 6.2

Amend Chapter 6.2 to read as follows:

"Chapter 6.2

Requirements for the construction and testing of pressure receptacles, aerosol dispensers, small receptacles containing gas (gas cartridges) and fuel cell cartridges containing liquefied flammable gas

[Ref. doc.: ST/SG/AC.10/C.3/2006/82]

6.2.1 General requirements

NOTE: Aerosol dispensers, small receptacles containing gas (gas cartridges) and fuel cell cartridges containing liquefied flammable gas are subject only to the requirements of 6.2.6.

6.2.1.1 Design and construction

6.2.1.1.1 Pressure receptacles and their closures shall be designed, manufactured, tested and equipped in such a way as to withstand all conditions, including fatigue, to which they will be subjected during normal conditions of carriage and use.

6.2.1.1.2 (Reserved)

6.2.1.1.3 In no case shall the minimum wall thickness be less than that specified in the design and construction technical standards.

6.2.1.1.4 For welded pressure receptacles, only metals of weldable quality shall be used.

6.2.1.1.5 The test pressure of cylinders, tubes, pressure drums and bundles of cylinders shall be in accordance with packing instruction P200 of 4.1.4.1. The test pressure for closed cryogenic receptacles shall be in accordance with packing instruction P203 of 4.1.4.1.

6.2.1.1.6 Pressure receptacles assembled in bundles shall be structurally supported and held together as a unit. Pressure receptacles shall be secured in a manner that prevents movement in relation to the structural assembly and movement that would result in the concentration of harmful local stresses. Manifold assemblies (e.g. manifold, valves, and pressure gauges) shall be designed and constructed such that they are protected from impact damage and forces normally encountered in carriage. Manifolds shall have at least the same test pressure as the cylinders. For toxic liquefied gases, each pressure receptacle shall have an isolation valve to ensure that each pressure receptacle can be filled separately and that no interchange of pressure receptacle contents can occur during carriage.

NOTE: Toxic liquefied gases have the classification codes 2T, 2TF, 2TC, 2TO, 2TFC or 2TOC.

6.2.1.1.7 Contact between dissimilar metals which could result in damage by galvanic action shall be avoided.

6.2.1.1.8 Additional requirements for the construction of closed cryogenic receptacles for refrigerated liquefied gases

6.2.1.1.8.1 The mechanical properties of the metal used shall be established for each pressure receptacle, including the impact strength and the bending coefficient.

NOTE: With regard to the impact strength, sub-section 6.8.5.3 gives details of test requirements which may be used.

6.2.1.1.8.2 The pressure receptacles shall be thermally insulated. The thermal insulation shall be protected against impact by means of a jacket. If the space between the pressure receptacle and the jacket is evacuated of air (vacuum-insulation), the jacket shall be designed to withstand without permanent deformation an external pressure of at least 100 kPa (1 bar) calculated in accordance with a recognised technical code or a calculated critical collapsing pressure of not less than 200 kPa (2 bar) gauge pressure. If the jacket is so closed as to be gas-tight (e.g. in the case of vacuum-insulation), a device shall be provided to prevent any dangerous pressure from developing in the insulating layer in the event of inadequate gas-tightness of the pressure receptacle or its fittings. The device shall prevent moisture from penetrating into the insulation.

6.2.1.1.8.3 Closed cryogenic receptacles intended for the carriage of refrigerated liquefied gases having a boiling point below $-182\text{ }^{\circ}\text{C}$ at atmospheric pressure shall not include materials which may react with oxygen or oxygen enriched atmospheres in a dangerous manner, when located in parts of the thermal insulation where there is a risk of contact with oxygen or with oxygen enriched liquid.

6.2.1.1.8.4 Closed cryogenic receptacles shall be designed and constructed with suitable lifting and securing arrangements.

6.2.1.1.9 Additional requirements for the construction of pressure receptacles for acetylene

Pressure receptacles for UN 1001 acetylene, dissolved, and UN 3374 acetylene, solvent free, shall be filled with a porous material, uniformly distributed, of a type that conforms to the requirements and testing specified by the competent authority and which:

- (a) Is compatible with the pressure receptacle and does not form harmful or dangerous compounds either with the acetylene or with the solvent in the case of UN 1001; and
- (b) Is capable of preventing the spread of decomposition of the acetylene in the porous material.

In the case of UN 1001, the solvent shall be compatible with the pressure receptacles.

6.2.1.2 Materials

6.2.1.2.1 Construction materials of pressure receptacles and their closures which are in direct contact with dangerous goods shall not be affected or weakened by the dangerous goods intended and shall not cause a dangerous effect e.g. catalysing a reaction or reacting with the dangerous goods.

6.2.1.2.2 Pressure receptacles and their closures shall be made of the materials specified in the design and construction technical standards and the applicable packing instruc-

tion for the substances intended for carriage in the pressure receptacle. The materials shall be resistant to brittle fracture and to stress corrosion cracking as indicated in the design and construction technical standards.

6.2.1.3 Service equipment

6.2.1.3.1 Valves, piping and other fittings subjected to pressure, excluding pressure relief devices, shall be designed and constructed so that the burst pressure is at least 1.5 times the test pressure of the pressure receptacle.

6.2.1.3.2 Service equipment shall be configured or designed to prevent damage that could result in the release of the pressure receptacle contents during normal conditions of handling and carriage. Manifold piping leading to shut-off valves shall be sufficiently flexible to protect the valves and the piping from shearing or releasing the pressure receptacle contents. The filling and discharge valves and any protective caps shall be capable of being secured against unintended opening. Valves shall be protected as specified in 4.1.6.8.

6.2.1.3.3 Pressure receptacles which are not capable of being handled manually or rolled, shall be fitted with devices (skids, rings, straps) ensuring that they can be safely handled by mechanical means and so arranged as not to impair the strength of, nor cause undue stresses in, the pressure receptacle.

6.2.1.3.4 Individual pressure receptacles shall be equipped with pressure relief devices as specified in packing provision P200 (2) of 4.1.4.1 or in 6.2.1.3.6.4 and 6.2.1.3.6.5. Pressure-relief devices shall be designed to prevent the entry of foreign matter, the leakage of gas and the development of any dangerous excess pressure. When fitted, pressure relief devices on manifolded horizontal pressure receptacles filled with flammable gas shall be arranged to discharge freely to the open air in such a manner as to prevent any impingement of escaping gas upon the pressure receptacle itself under normal conditions of carriage.

6.2.1.3.5 Pressure receptacles whose filling is measured by volume shall be provided with a level indicator.

6.2.1.3.6 Additional requirements for closed cryogenic receptacles

6.2.1.3.6.1 Each filling and discharge opening in a closed cryogenic receptacle used for the carriage of flammable refrigerated liquefied gases shall be fitted with at least two mutually independent shut-off devices in series, the first being a stop-valve, the second being a cap or equivalent device.

6.2.1.3.6.2 For sections of piping which can be closed at both ends and where liquid product can be trapped, a method of automatic pressure-relief shall be provided to prevent excess pressure build-up within the piping.

6.2.1.3.6.3 Each connection on a closed cryogenic receptacle shall be clearly marked to indicate its function (e.g. vapour or liquid phase).

6.2.1.3.6.4 Pressure-relief devices

6.2.1.3.6.4.1 Every closed cryogenic receptacle shall be provided with at least one pressure-relief device. The pressure-relief device shall be of the type that will resist dynamic forces including surge.

6.2.1.3.6.4.2 Closed cryogenic receptacles may, in addition, have a frangible disc in parallel with the spring loaded device(s) in order to meet the requirements of 6.2.1.3.6.5.

6.2.1.3.6.4.3 Connections to pressure-relief devices shall be of sufficient size to enable the required discharge to pass unrestricted to the pressure-relief device.

6.2.1.3.6.4.4 All pressure-relief device inlets shall under maximum filling conditions be situated in the vapour space of the closed cryogenic receptacle and the devices shall be so arranged as to ensure that the escaping vapour is discharged unrestrictedly.

6.2.1.3.6.5 Capacity and setting of pressure-relief devices

NOTE: In relation to pressure-relief devices of closed cryogenic receptacles, maximum allowable working pressure (MAWP) means the maximum effective gauge pressure permissible at the top of a loaded closed cryogenic receptacle in its operating position including the highest effective pressure during filling and discharge.

6.2.1.3.6.5.1 The pressure-relief device shall open automatically at a pressure not less than the MAWP and be fully open at a pressure equal to 110% of the MAWP. It shall, after discharge, close at a pressure not lower than 10% below the pressure at which discharge starts and shall remain closed at all lower pressures.

6.2.1.3.6.5.2 Frangible discs shall be set to rupture at a nominal pressure which is the lower of either the test pressure or 150% of the MAWP.

6.2.1.3.6.5.3 In the case of the loss of vacuum in a vacuum-insulated closed cryogenic receptacle the combined capacity of all pressure-relief devices installed shall be sufficient so that the pressure (including accumulation) inside the closed cryogenic receptacle does not exceed 120% of the MAWP.

6.2.1.3.6.5.4 The required capacity of the pressure-relief devices shall be calculated in accordance with an established technical code recognized by the competent authority⁶.

6.2.1.4 Approval of pressure receptacles

6.2.1.4.1 The conformity of pressure receptacles shall be assessed at time of manufacture as required by the competent authority. Pressure receptacles shall be inspected, tested and approved by an inspection body. The technical documentation shall include full specifications on design and construction, and full documentation on the manufacturing and testing.

6.2.1.4.2 Quality assurance systems shall conform to the requirements of the competent authority.

[Ref. doc.: INF.21 JM 09/07]

⁶ See for example CGA Publications S-1.2-2003 "Pressure Relief Device Standards – Part 2 – Cargo and Portable Tanks for Compressed Gases" and S-1.1-2003 "Pressure Relief Device Standards – Part 1 – Cylinders for Compressed Gases".

6.2.1.5 Initial inspection and test

6.2.1.5.1 New pressure receptacles, other than closed cryogenic receptacles, shall be subjected to testing and inspection during and after manufacture in accordance with the applicable design standards including the following:

On an adequate sample of pressure receptacles:

- (a) Testing of the mechanical characteristics of the material of construction;
- (b) Verification of the minimum wall thickness;
- (c) Verification of the homogeneity of the material for each manufacturing batch;
- (d) Inspection of the external and internal conditions of the pressure receptacles;
- (e) Inspection of the neck threads;
- (f) Verification of the conformance with the design standard;

For all pressure receptacles:

- (g) A hydraulic pressure test. Pressure receptacles shall withstand the test pressure without expansion greater than that allowed in the design specification;

NOTE: With the agreement of the competent authority, the hydraulic pressure test may be replaced by a test using a gas, where such an operation does not entail any danger.

- (h) Inspection and assessment of manufacturing defects and either repairing them or rendering the pressure receptacles unserviceable. In the case of welded pressure receptacles, particular attention shall be paid to the quality of the welds;
- (i) An inspection of the markings on the pressure receptacles;
- (j) In addition, pressure receptacles intended for the carriage of UN No. 1001 acetylene, dissolved, and UN No. 3374 acetylene, solvent free, shall be inspected to ensure proper installation and condition of the porous material and, if applicable, the quantity of solvent.

6.2.1.5.2 On an adequate sample of closed cryogenic receptacles, the inspections and tests specified in 6.2.1.5.1 (a), (b), (d) and (f) shall be performed. In addition, welds shall be inspected by radiographic, ultrasonic or another suitable non-destructive test method on a sample of closed cryogenic receptacles according to the applicable design and construction standard. This weld inspection does not apply to the jacket.

Additionally, all closed cryogenic receptacles shall undergo the initial inspections and tests specified in 6.2.1.5.1 (g), (h) and (i), as well as a leakproofness test and a test of the satisfactory operation of the service equipment after assembly.

[Ref. doc.: ST/SG/AC.10/C.3/2006/75; Consequential amendments see under 6.2.1.4.2, 6.2.3.4.1 and 6.2.3.4.2 (a)]

6.2.1.6 Periodic inspection and test

6.2.1.6.1 Refillable pressure receptacles, other than cryogenic receptacles, shall be subjected to periodic inspections and tests by a body authorised by the competent authority, in accordance with the following:

- (a) Check of the external conditions of the pressure receptacle and verification of the equipment and the external markings;
- (b) Check of the internal conditions of the pressure receptacle (e.g. internal inspection, verification of minimum wall thickness);
- (c) Checking of the threads if there is evidence of corrosion or if the fittings are removed;
- (d) A hydraulic pressure test and, if necessary, verification of the characteristics of the material by suitable tests;
- (e) Check of service equipment, other accessories and pressure-relief devices, if to be reintroduced into service.

NOTE 1: With the agreement of the competent authority, the hydraulic pressure test may be replaced by a test using a gas, where such an operation does not entail any danger.

2: With the agreement of the competent authority, the hydraulic pressure test of cylinders or tubes may be replaced by an equivalent method based on acoustic emission testing, ultrasonic examination or a combination of acoustic emission testing and ultrasonic examination.

3: For the periodic inspection and test frequencies, see packing instruction P200 in 4.1.4.1.

[Ref. doc.: ST/SG/AC.10/C.3/2006/75 + INF.5 JM 09/07]

6.2.1.6.2 Pressure receptacles intended for the carriage of UN No. 1001 acetylene, dissolved and UN No. 3374 acetylene, solvent free, shall be examined only as specified in 6.2.1.6.1 (a), (c) and (e). In addition the condition of the porous material (e.g. cracks, top clearance, loosening, settlement) shall be examined.

[Consequential amendments see under 4.1.4.1 P 200 and P 203, 4.1.6.4, 4.1.6.10, 6.2.3.5.1, 6.7.5.12.4 and 6.8.3.4.13]

[Ref. doc.: ST/SG/AC.10/C.3/2006/75 + INF.21 JM 09/07]

6.2.1.7 Requirements for manufacturers

6.2.1.7.1 The manufacturer shall be technically able and shall possess all resources required for the satisfactory manufacture of pressure receptacles; this relates in particular to qualified personnel:

- (a) To supervise the entire manufacturing process;
- (b) To carry out joining of materials; and
- (c) To carry out the relevant tests.

6.2.1.7.2 The proficiency test of a manufacturer shall in all instances be carried out by an inspection body approved by the competent authority of the country of approval.

6.2.1.8 Requirements for inspection bodies

6.2.1.8.1 Inspection bodies shall be independent from manufacturing enterprises and competent to perform the tests, inspections and approvals required.

6.2.2 Requirements for UN pressure receptacles

In addition to the general requirements of section 6.2.1, UN pressure receptacles shall comply with the requirements of this section, including the standards, as applicable.

6.2.2.1 Design, construction and initial inspection and test

6.2.2.1.1 The following standards apply for the design, construction, and initial inspection and test of UN cylinders, except that inspection requirements related to the conformity assessment system and approval shall be in accordance with 6.2.2.5:

ISO 9809-1:1999	Gas cylinders – Refillable seamless steel gas cylinders – Design, construction and testing – Part 1: Quenched and tempered steel cylinders with tensile strength less than 1100 MPa NOTE: The note concerning the F factor in section 7.3 of this standard shall not be applied for UN cylinders.
ISO 9809-2:2000	Gas cylinders – Refillable seamless steel gas cylinders – Design, construction and testing – Part 2: Quenched and tempered steel cylinders with tensile strength greater than or equal to 1100 MPa
ISO 9809-3:2000	Gas cylinders – Refillable seamless steel gas cylinders – Design, construction and testing – Part 3: Normalized steel cylinders
ISO 7866:1999	Gas cylinders – Refillable seamless aluminium alloy gas cylinders – Design, construction and testing NOTE: The note concerning the F factor in section 7.2 of this standard shall not be applied for UN cylinders. Aluminium alloy 6351A – T6 or equivalent shall not be authorised.
ISO 11118:1999	Gas cylinders – Non-refillable metallic gas cylinders – Specification and test methods
ISO 11119-1:2002	Gas cylinders of composite construction – Specification and test methods – Part 1: Hoop wrapped composite gas cylinders
ISO 11119-2:2002	Gas cylinders of composite construction – Specification and test methods – Part 2: Fully wrapped fibre reinforced composite gas cylinders with load-sharing metal liners
ISO 11119-3:2002	Gas cylinders of composite construction – Specification and test methods – Part 3: Fully wrapped fibre reinforced composite gas cylinders with non-load-sharing metallic or non-metallic liners

NOTE 1: In the above referenced standards composite cylinders shall be designed for unlimited service life.

2: After the first 15 years of service, composite cylinders manufactured according to these standards, may be approved for extended service by

the competent authority which was responsible for the original approval of the cylinders and which will base its decision on the test information supplied by the manufacturer or owner or user.

6.2.2.1.2 The following standard apply for the design, construction, and initial inspection and test of UN tubes, except that inspection requirements related to the conformity assessment system and approval shall be in accordance with 6.2.2.5:

ISO 11120:1999	Gas cylinders – Refillable seamless steel tubes for compressed gas transport, of water capacity between 150 l and 3000 l – Design, construction and testing NOTE: The note concerning the F factor in section 7.1 of this standard shall not be applied for UN tubes.
----------------	---

6.2.2.1.3 The following standards apply for the design, construction and initial inspection and test of UN acetylene cylinders, except that inspection requirements related to the conformity assessment system and approval shall be in accordance with 6.2.2.5:

For the cylinder shell:

ISO 9809-1:1999	Gas cylinders – Refillable seamless steel gas cylinders – Design, construction and testing – Part 1: Quenched and tempered steel cylinders with tensile strength less than 1100 MPa NOTE: The note concerning the F factor in section 7.3 of this standard shall not be applied for UN cylinders.
ISO 9809-3:2000	Gas cylinders – Refillable seamless steel gas cylinders – Design, construction and testing – Part 3: Normalized steel cylinders

For the porous material in the cylinder:

ISO 3807-1:2000	Cylinders for acetylene – Basic requirements – Part 1: Cylinders without fusible plugs
ISO 3807-2:2000	Cylinders for acetylene – Basic requirements – Part 2: Cylinders with fusible plugs

6.2.2.1.4 The following standard apply for the design, construction, and initial inspection and test of UN cryogenic receptacles, except that inspection requirements related to the conformity assessment system and approval shall be in accordance with 6.2.2.5:

ISO 21029-1:2004	Cryogenic vessels – Transportable vacuum insulated vessels of not more than 1000 l volume – Part 1: Design, fabrication, inspection and tests
------------------	---

6.2.2.2 Materials

In addition to the material requirements specified in the pressure receptacle design and construction standards, and any restrictions specified in the applicable packing instruction for the gas(es) to be carried (e.g. packing instruction P200 of 4.1.4.1), the following standards apply to material compatibility:

ISO 11114-1:1997	Transportable gas cylinders – Compatibility of cylinder and valve materials with gas contents – Part 1: Metallic materials
ISO 11114-2:2000	Transportable gas cylinders – Compatibility of cylinder and valve materials with gas contents – Part 2: Non-metallic materials

NOTE: The limitations imposed in ISO 11114-1 on high strength steel alloys at ultimate tensile strength levels up to 1 100 MPa do not apply to UN No. 2203 silane.

[Ref. doc.: ST/SG/AC.10/C.3/2006/94]

6.2.2.3 Service equipment

The following standards apply to closures and their protection:

ISO 11117:1998	Gas cylinders – Valve protection caps and valve guards for industrial and medical gas cylinders – Design, construction and tests
ISO 10297:1999	Gas cylinders – Refillable gas cylinder valves – Specification and type testing NOTE: The EN version of this ISO standard fulfils the requirements and may also be used.

6.2.2.4 Periodic inspection and test

The following standards apply to the periodic inspection and testing of UN cylinders:

ISO 6406:2005	Periodic inspection and testing of seamless steel gas cylinders
ISO 10461:2005 + A1:2006	Seamless aluminium-alloy gas cylinders – Periodic inspection and testing
ISO 10462:2005	Gas cylinders – Transportable cylinders for dissolved acetylene – Periodic inspection and maintenance
ISO 11623:2002	Transportable gas cylinders – Periodic inspection and testing of composite gas cylinders

[Ref. doc.: ST/SG/AC.10/C.3/2006/87]

6.2.2.5 Conformity assessment system and approval for manufacture of pressure receptacles

6.2.2.5.1 Definitions

For the purposes of this sub-section:

Conformity assessment system means a system for competent authority approval of a manufacturer, by pressure receptacle design type approval, approval of manufacturer's quality system and approval of inspection bodies;

Design type means a pressure receptacle design as specified by a particular pressure receptacle standard;

Verify means confirm by examination or provision of objective evidence that specified requirements have been fulfilled.

6.2.2.5.2 General requirements

Competent authority

6.2.2.5.2.1 The competent authority that approves the pressure receptacle shall approve the conformity assessment system for the purpose of ensuring that pressure receptacles conform to the requirements of RID. In instances where the competent authority that approves a pressure receptacle is not the competent authority in the country of manufacture, the marks of the approval country and the country of manufacture shall be indicated in the pressure receptacle marking (see 6.2.2.7 and 6.2.2.8).

The competent authority of the country of approval shall supply, upon request, evidence demonstrating compliance to this conformity assessment system to its counterpart in a country of use.

6.2.2.5.2.2 The competent authority may delegate its functions in this conformity assessment system in whole or in part.

6.2.2.5.2.3 The competent authority shall ensure that a current list of approved inspection bodies and their identity marks and approved manufacturers and their identity marks is available.

Inspection body

6.2.2.5.2.4 The inspection body shall be approved by the competent authority for the inspection of pressure receptacles and shall:

- (a) Have a staff with an organisational structure, capable, trained, competent, and skilled, to satisfactorily perform its technical functions;
- (b) Have access to suitable and adequate facilities and equipment;
- (c) Operate in an impartial manner and be free from any influence which could prevent it from doing so;
- (d) Ensure commercial confidentiality of the commercial and proprietary activities of the manufacturer and other bodies;
- (e) Maintain clear demarcation between actual inspection body functions and unrelated functions;
- (f) Operate a documented quality system;
- (g) Ensure that the tests and inspections specified in the relevant pressure receptacle standard and RID are performed; and
- (h) Maintain an effective and appropriate report and record system in accordance with 6.2.2.5.6.

6.2.2.5.2.5 The inspection body shall perform design type approval, pressure receptacle production testing and inspection, and certification to verify conformity with the relevant pressure receptacle standard (see 6.2.2.5.4 and 6.2.2.5.5).

Manufacturer

6.2.2.5.2.6 The manufacturer shall:

- (a) Operate a documented quality system in accordance with 6.2.2.5.3;
- (b) Apply for design type approvals in accordance with 6.2.2.5.4;
- (c) Select an inspection body from the list of approved inspection bodies maintained by the competent authority in the country of approval; and
- (d) Maintain records in accordance with 6.2.2.5.6.

Testing laboratory

6.2.2.5.2.7 The testing laboratory shall have:

- (a) Staff with an organisational structure, sufficient in number, competence, and skill; and
- (b) Suitable and adequate facilities and equipment to perform the tests required by the manufacturing standard to the satisfaction of the inspection body.

6.2.2.5.3 Manufacturer's quality system

6.2.2.5.3.1 The quality system shall contain all the elements, requirements, and provisions adopted by the manufacturer. It shall be documented in a systematic and orderly manner in the form of written policies, procedures and instructions.

The contents shall in particular include adequate descriptions of:

- (a) The organisational structure and responsibilities of personnel with regard to design and product quality;
- (b) The design control and design verification techniques, processes, and procedures that will be used when designing the pressure receptacles;
- (c) The relevant pressure receptacle manufacturing, quality control, quality assurance and process operation instructions that will be used;
- (d) Quality records, such as inspection reports, test data and calibration data;
- (e) Management reviews to ensure the effective operation of the quality system arising from the audits in accordance with 6.2.2.5.3.2;
- (f) The process describing how customer requirements are met;
- (g) The process for control of documents and their revision;
- (h) The means for control of non-conforming pressure receptacles, purchased components, in-process and final materials; and
- (i) Training programmes and qualification procedures for relevant personnel.

6.2.2.5.3.2 Audit of the quality system

The quality system shall be initially assessed to determine whether it meets the requirements in 6.2.2.5.3.1 to the satisfaction of the competent authority.

The manufacturer shall be notified of the results of the audit. The notification shall contain the conclusions of the audit and any corrective actions required.

Periodic audits shall be carried out, to the satisfaction of the competent authority, to ensure that the manufacturer maintains and applies the quality system. Reports of the periodic audits shall be provided to the manufacturer.

6.2.2.5.3.3 Maintenance of the quality system

The manufacturer shall maintain the quality system as approved in order that it remains adequate and efficient.

The manufacturer shall notify the competent authority that approved the quality system, of any intended changes. The proposed changes shall be evaluated in order to determine whether the amended quality system will still satisfy the requirements in 6.2.2.5.3.1.

6.2.2.5.4 Approval process

Initial design type approval

6.2.2.5.4.1 The initial design type approval shall consist of approval of the manufacturer's quality system and approval of the pressure receptacle design to be produced. An application for an initial design type approval shall meet the requirements of 6.2.2.5.4.2 to 6.2.2.5.4.6 and 6.2.2.5.4.9.

6.2.2.5.4.2 A manufacturer desiring to produce pressure receptacles in accordance with a pressure receptacle standard and RID shall apply for, obtain, and retain a design type approval certificate issued by the competent authority in the country of approval for at least one pressure receptacle design type in accordance with the procedure given in 6.2.2.5.4.9. This certificate shall, on request, be submitted to the competent authority of the country of use.

6.2.2.5.4.3 An application shall be made for each manufacturing facility and shall include:

- (a) The name and registered address of the manufacturer and in addition, if the application is submitted by an authorised representative, its name and address;
- (b) The address of the manufacturing facility (if different from the above);
- (c) The name and title of the person(s) responsible for the quality system;
- (d) The designation of the pressure receptacle and the relevant pressure receptacle standard;
- (e) Details of any refusal of approval of a similar application by any other competent authority;
- (f) The identity of the inspection body for design type approval;
- (g) Documentation on the manufacturing facility as specified under 6.2.2.5.3.1; and

- (h) The technical documentation required for design type approval, which shall enable verification of the conformity of the pressure receptacles with the requirements of the relevant pressure receptacle design standard. The technical documentation shall cover the design and method of manufacture and shall contain, as far as is relevant for assessment, at least the following:
 - (i) pressure receptacle design standard, design and manufacturing drawings, showing components and subassemblies, if any;
 - (ii) descriptions and explanations necessary for the understanding of the drawings and intended use of the pressure receptacles;
 - (iii) a list of the standards necessary to fully define the manufacturing process;
 - (iv) design calculations and material specifications; and
 - (v) design type approval test reports, describing the results of examinations and tests carried out in accordance with 6.2.2.5.4.9.

6.2.2.5.4.4 An initial audit in accordance with 6.2.2.5.3.2 shall be performed to the satisfaction of the competent authority.

6.2.2.5.4.5 If the manufacturer is denied approval, the competent authority shall provide written detailed reasons for such denial.

6.2.2.5.4.6 Following approval, changes to the information submitted under 6.2.2.5.4.3 relating to the initial approval shall be provided to the competent authority.

Subsequent design type approvals

6.2.2.5.4.7 An application for a subsequent design type approval shall meet the requirements of 6.2.2.5.4.8 and 6.2.2.5.4.9, provided a manufacturer is in the possession of an initial design type approval. In such a case, the manufacturer's quality system according to 6.2.2.5.3 shall have been approved during the initial design type approval and shall be applicable for the new design.

6.2.2.5.4.8 The application shall include:

- (a) The name and address of the manufacturer and in addition, if the application is submitted by an authorised representative, its name and address;
- (b) Details of any refusal of approval of a similar application by any other competent authority;
- (c) Evidence that initial design type approval has been granted; and
- (d) The technical documentation, as described in 6.2.2.5.4.3 (h).

Procedure for design type approval

6.2.2.5.4.9 The inspection body shall:

- (a) Examine the technical documentation to verify that:
 - (i) the design is in accordance with the relevant provisions of the standard, and

- (ii) the prototype lot has been manufactured in conformity with the technical documentation and is representative of the design;
- (b) Verify that the production inspections have been carried out as required in accordance with 6.2.2.5.5;
- (c) Select pressure receptacles from a prototype production lot and supervise the tests of these pressure receptacles as required for design type approval;
- (d) Perform or have performed the examinations and tests specified in the pressure receptacle standard to determine that:
 - (i) the standard has been applied and fulfilled, and
 - (ii) the procedures adopted by the manufacturer meet the requirements of the standard; and
- (e) Ensure that the various type approval examinations and tests are correctly and competently carried out.

After prototype testing has been carried out with satisfactory results and all applicable requirements of 6.2.2.5.4 have been satisfied, a design type approval certificate shall be issued, which shall include the name and address of the manufacturer, results and conclusions of the examination, and the necessary data for identification of the design type.

If the manufacturer is denied a design type approval, the competent authority shall provide written detailed reasons for such denial.

6.2.2.5.4.10 Modifications to approved design types

The manufacturer shall either:

- (a) Inform the issuing competent authority of modifications to the approved design type, where such modifications do not constitute a new design, as specified in the pressure receptacle standard; or
- (b) Request a subsequent design type approval where such modifications constitute a new design according to the relevant pressure receptacle standard. This additional approval shall be given in the form of an amendment to the original design type approval certificate.

6.2.2.5.4.11 Upon request, the competent authority shall communicate to any other competent authority, information concerning design type approval, modifications of approvals and withdrawn approvals.

6.2.2.5.5 Production inspection and certification

General requirements

An inspection body, or its delegate, shall carry out the inspection and certification of each pressure receptacle. The inspection body selected by the manufacturer for inspection and testing during production may be different from the inspection body used for the design type approval testing.

Where it can be demonstrated to the satisfaction of the inspection body that the manufacturer has trained competent inspectors, independent of the manufacturing

operations, inspection may be performed by those inspectors. In such a case, the manufacturer shall maintain training records of the inspectors.

The inspection body shall verify that the inspections by the manufacturer, and tests performed on those pressure receptacles, fully conform to the standard and the requirements of RID. Should non-conformance in conjunction with this inspection and testing be determined, the permission to have inspection performed by the manufacturer's inspectors may be withdrawn.

The manufacturer shall, after approval by the inspection body, make a declaration of conformity with the certified design type. The application of the pressure receptacle certification marking shall be considered a declaration that the pressure receptacle complies with the applicable pressure receptacle standards and the requirements of this conformity assessment system and RID. The inspection body shall affix or delegate the manufacturer to affix the pressure receptacle certification marking and the registered mark of the inspection body to each approved pressure receptacle.

A certificate of compliance, signed by the inspection body and the manufacturer, shall be issued before the pressure receptacles are filled.

6.2.2.5.6 Records

Design type approval and certificate of compliance records shall be retained by the manufacturer and the inspection body for not less than 20 years.

6.2.2.6 Approval system for periodic inspection and test of pressure receptacles

6.2.2.6.1 Definition

For the purposes of this section:

Approval system means a system for competent authority approval of a body performing periodic inspection and test of pressure receptacles (hereinafter referred to as "periodic inspection and test body"), including approval of that body's quality system.

6.2.2.6.2 General requirements

Competent authority

6.2.2.6.2.1

The competent authority shall establish an approval system for the purpose of ensuring that the periodic inspection and test of pressure receptacles conform to the requirements of RID. In instances where the competent authority that approves a body performing periodic inspection and test of a pressure receptacle is not the competent authority of the country approving the manufacture of the pressure receptacle, the marks of the approval country of periodic inspection and test shall be indicated in the pressure receptacle marking (see 6.2.2.7).

The competent authority of the country of approval for the periodic inspection and test shall supply, upon request, evidence demonstrating compliance to this approval system including the records of the periodic inspection and test to its counterpart in a country of use.

The competent authority of the country of approval may terminate the approval certificate referred to in 6.2.2.6.4.1, upon evidence demonstrating non-compliance with the approval system.

6.2.2.6.2.2 The competent authority may delegate its functions in this approval system, in whole or in part.

6.2.2.6.2.3 The competent authority shall ensure that a current list of approved periodic inspection and test bodies and their identity marks is available.

Periodic inspection and test body

6.2.2.6.2.4 The periodic inspection and test body shall be approved by the competent authority and shall:

- (a) Have a staff with an organisational structure, capable, trained, competent, and skilled, to satisfactorily perform its technical functions;
- (b) Have access to suitable and adequate facilities and equipment;
- (c) Operate in an impartial manner and be free from any influence which could prevent it from doing so;
- (d) Ensure commercial confidentiality;
- (e) Maintain clear demarcation between actual periodic inspection and test body functions and unrelated functions;
- (f) Operate a documented quality system accordance with 6.2.2.6.3;
- (g) Apply for approval in accordance with 6.2.2.6.4;
- (h) Ensure that the periodic inspections and tests are performed in accordance with 6.2.2.6.5; and
- (i) Maintain an effective and appropriate report and record system in accordance with 6.2.2.6.6.

6.2.2.6.3 Quality system and audit of the periodic inspection and test body

6.2.2.6.3.1 Quality system

The quality system shall contain all the elements, requirements, and provisions adopted by the periodic inspection and test body. It shall be documented in a systematic and orderly manner in the form of written policies, procedures, and instructions.

The quality system shall include:

- (a) A description of the organisational structure and responsibilities;
- (b) The relevant inspection and test, quality control, quality assurance, and process operation instructions that will be used;
- (c) Quality records, such as inspection reports, test data, calibration data and certificates;
- (d) Management reviews to ensure the effective operation of the quality system arising from the audits performed in accordance with 6.2.2.6.3.2;
- (e) A process for control of documents and their revision;

- (f) A means for control of non-conforming pressure receptacles; and
- (g) Training programmes and qualification procedures for relevant personnel.

6.2.2.6.3.2 Audit

The periodic inspection and test body and its quality system shall be audited in order to determine whether it meets the requirements of RID to the satisfaction of the competent authority.

An audit shall be conducted as part of the initial approval process (see 6.2.2.6.4.3). An audit may be required as part of the process to modify an approval (see 6.2.2.6.4.6).

Periodic audits shall be conducted, to the satisfaction of the competent authority, to ensure that the periodic inspection and test body continues to meet the requirements of RID.

The periodic inspection and test body shall be notified of the results of any audit. The notification shall contain the conclusions of the audit and any corrective actions required.

6.2.2.6.3.3 Maintenance of the quality system

The periodic inspection and test body shall maintain the quality system as approved in order that it remains adequate and efficient.

The periodic inspection and test body shall notify the competent authority that approved the quality system, of any intended changes, in accordance with the process for modification of an approval in 6.2.2.6.4.6.

6.2.2.6.4 Approval process for periodic inspection and test bodies

Initial approval

6.2.2.6.4.1 A body desiring to perform periodic inspection and test of pressure receptacles in accordance with a pressure receptacle standard and RID shall apply for, obtain, and retain an approval certificate issued by the competent authority.

This written approval shall, on request, be submitted to the competent authority of a country of use.

6.2.2.6.4.2 An application shall be made for each periodic inspection and test body and shall include:

- (a) The name and address of the periodic inspection and test body and, if the application is submitted by an authorised representative, its name and address;
- (b) The address of each facility performing periodic inspection and test;
- (c) The name and title of the person(s) responsible for the quality system;
- (d) The designation of the pressure receptacles, the periodic inspection and test methods, and the relevant pressure receptacle standards met by the quality system;

- (e) Documentation on each facility, the equipment, and the quality system as specified under 6.2.2.6.3.1;
- (f) The qualifications and training records of the periodic inspection and test personnel; and
- (g) Details of any refusal of approval of a similar application by any other competent authority.

6.2.2.6.4.3 The competent authority shall:

- (a) Examine the documentation to verify that the procedures are in accordance with the requirements of the relevant pressure receptacle standards and RID; and
- (b) Conduct an audit in accordance with 6.2.2.6.3.2 to verify that the inspections and tests are carried out as required by the relevant pressure receptacle standards and RID, to the satisfaction of the competent authority.

6.2.2.6.4.4 After the audit has been carried out with satisfactory results and all applicable requirements of 6.2.2.6.4 have been satisfied, an approval certificate shall be issued. It shall include the name of the periodic inspection and test body, the registered mark, the address of each facility, and the necessary data for identification of its approved activities (e.g. designation of pressure receptacles, periodic inspection and test method and pressure receptacle standards).

6.2.2.6.4.5 If the periodic inspection and test body is denied approval, the competent authority shall provide written detailed reasons for such denial.

Modifications to periodic inspection and test body approvals

6.2.2.6.4.6 Following approval, the periodic inspection and test body shall notify the issuing competent authority of any modifications to the information submitted under 6.2.2.6.4.2 relating to the initial approval.

The modifications shall be evaluated in order to determine whether the requirements of the relevant pressure receptacle standards and RID will be satisfied. An audit in accordance with 6.2.2.6.3.2 may be required. The competent authority shall accept or reject these modifications in writing, and an amended approval certificate shall be issued as necessary.

6.2.2.6.4.7 Upon request, the competent authority shall communicate to any other competent authority, information concerning initial approvals, modifications of approvals, and withdrawn approvals.

6.2.2.6.5 Periodic inspection and test and certification

The application of the periodic inspection and test marking to a pressure receptacle shall be considered a declaration that the pressure receptacle complies with the applicable pressure receptacle standards and the requirements of RID. The periodic inspection and test body shall affix the periodic inspection and test marking, including its registered mark, to each approved pressure receptacle (see 6.2.2.7.6).

A record certifying that a pressure receptacle has passed the periodic inspection and test shall be issued by the periodic inspection and test body, before the pressure receptacle is filled.

6.2.2.6.6 Records

The periodic inspection and test body shall retain records of pressure receptacle periodic inspection and tests (both passed and failed) including the location of the test facility, for not less than 15 years.

The owner of the pressure receptacle shall retain an identical record until the next periodic inspection and test unless the pressure receptacle is permanently removed from service.

6.2.2.7 Marking of refillable UN pressure receptacles

Refillable UN pressure receptacles shall be marked clearly and legibly with certification, operational and manufacturing marks. These marks shall be permanently affixed (e.g. stamped, engraved, or etched) on the pressure receptacle. The marks shall be on the shoulder, top end or neck of the pressure receptacle or on a permanently affixed component of the pressure receptacle (e.g. welded collar or corrosion resistant plate welded on the outer jacket of a closed cryogenic receptacle). Except for the UN packaging symbol, the minimum size of the marks shall be 5 mm for pressure receptacles with a diameter greater than or equal to 140 mm and 2.5 mm for pressure receptacles with a diameter less than 140 mm. The minimum size of the UN packaging symbol shall be 10 mm for pressure receptacles with a diameter greater than or equal to 140 mm and 5 mm for pressure receptacles with a diameter less than 140 mm.

6.2.2.7.1 The following certification marks shall be applied:

- (a) The United Nations packaging symbol .

This symbol shall not be used for any purpose other than certifying that a packaging complies with the relevant requirements in Chapter 6.1, 6.2, 6.3, 6.5 or 6.6. This symbol shall not be used for pressure receptacles which only conform to the requirements of 6.2.3 to 6.2.5 (see 6.2.3.9).

[Ref. doc.: ECE/TRANS/WP.15/AC.1/2007/32, Consequential amendment]

- (b) The technical standard (e.g. ISO 9809-1) used for design, manufacture and testing;
- (c) The character(s) identifying the country of approval as indicated by the distinguishing signs of motor vehicles in international traffic;

NOTE: The country of approval shall be understood to be the country that approved the body which inspected the individual receptacle at time of manufacture.

- (d) The identity mark or stamp of the inspection body that is registered with the competent authority of the country authorizing the marking;
- (e) The date of the initial inspection, the year (four digits) followed by the month (two digits) separated by a slash (i.e. "/");

6.2.2.7.2

The following operational marks shall be applied:

- (f) The test pressure in bar, preceded by the letters "PH" and followed by the letters "BAR";
- (g) The mass of the empty pressure receptacle including all permanently attached integral parts (e.g. neck ring, foot ring, etc.) in kilograms, followed by the letters "KG". This mass shall not include the mass of valve, valve cap or valve guard, any coating, or porous material for acetylene. The mass shall be expressed to three significant figures rounded up to the last digit. For cylinders of less than 1 kg, the mass shall be expressed to two significant figures rounded up to the last digit. In the case of pressure receptacles for UN No. 1001 acetylene, dissolved and UN No. 3374 acetylene, solvent free, at least one decimal shall be shown after the decimal point and two digits for pressure receptacles of less than 1 kg;
- (h) The minimum guaranteed wall thickness of the pressure receptacle in millimetres followed by the letters "MM". This mark is not required for pressure receptacles with a water capacity less than or equal to 1 litre or for composite cylinders or for closed cryogenic receptacles;
- (i) In the case of pressure receptacles for compressed gases, UN No. 1001 acetylene, dissolved, and UN No. 3374 acetylene, solvent free, the working pressure in bar, preceded by the letters "PW". In the case of closed cryogenic receptacles, the maximum allowable working pressure preceded by the letters "MAWP";
- (j) In the case of pressure receptacles for liquefied gases and refrigerated liquefied gases, the water capacity in litres expressed to three significant digits rounded down to the last digit, followed by the letter "L". If the value of the minimum or nominal water capacity is an integer, the figures after the decimal point may be neglected;
- (k) In the case of pressure receptacles for UN No. 1001 acetylene, dissolved, the total of the mass of the empty receptacle, the fittings and accessories not removed during filling, any coating, the porous material, the solvent and the saturation gas expressed to three significant figures rounded down to the last digit followed by the letters "KG". At least one decimal shall be shown after the decimal point. For pressure receptacles of less than 1 kg, the mass shall be expressed to two significant figures rounded down to the last digit;
- (l) In the case of pressure receptacles for UN No. 3374 acetylene, solvent free, the total of the mass of the empty receptacle, the fittings and accessories not removed during filling, any coating, and the porous material expressed to three significant figures rounded down to the last digit followed by the letters "KG". At least one decimal shall be shown after the decimal point. For pressure receptacles of less than 1 kg, the mass shall be expressed to two significant figures rounded down to the last digit;

6.2.2.7.3 The following manufacturing marks shall be applied:

- (m) Identification of the cylinder thread (e.g. 25E). This mark is not required for closed cryogenic receptacles;
- (n) The manufacturer's mark registered by the competent authority. When the country of manufacture is not the same as the country of approval, then the manufacturer's mark shall be preceded by the character(s) identifying the country of manufacture as indicated by the distinguishing signs of motor vehicles in international traffic. The country mark and the manufacturer's mark shall be separated by a space or slash;
- (o) The serial number assigned by the manufacturer;
- (p) In the case of steel pressure receptacles and composite pressure receptacles with steel liner intended for the carriage of gases with a risk of hydrogen embrittlement, the letter "H" showing compatibility of the steel (see ISO 11114-1:1997).

6.2.2.7.4 The above marks shall be placed in three groups:

- Manufacturing marks shall be the top grouping and shall appear consecutively in the sequence given in 6.2.2.7.3.
- The operational marks in 6.2.2.7.2 shall be the middle grouping and the test pressure (f) shall be immediately preceded by the working pressure (i) when the latter is required.
- Certification marks shall be the bottom grouping and shall appear in the sequence given in 6.2.2.7.1.

The following is an example of the markings applied to a cylinder.

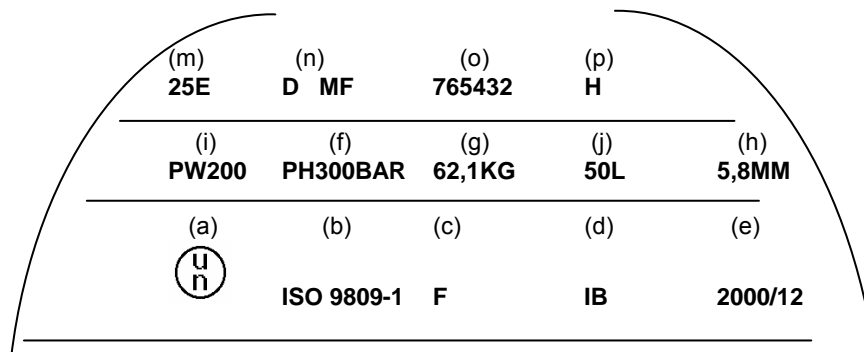

6.2.2.7.5 Other marks are allowed in areas other than the side wall, provided they are made in low stress areas and are not of a size and depth that will create harmful stress concentrations. In the case of closed cryogenic receptacles, such marks may be on a separate plate attached to the outer jacket. Such marks shall not conflict with required marks.

6.2.2.7.6 In addition to the preceding marks, each refillable pressure receptacle that meets the periodic and test requirements of 6.2.2.4 shall be marked indicating:

- (a) The character(s) identifying the country authorizing the body performing the periodic inspection and test. This marking is not required if this body is approved by the competent authority of the country approving manufacture;

- (b) The registered mark of the body authorised by the competent authority for performing periodic inspection and test;
- (c) The date of the periodic inspection and test, the year (two digits) followed by the month (two digits) separated by a slash (i.e. "/"). Four digits may be used to indicate the year.

The above marks shall appear consecutively in the sequence given.

6.2.2.7.7 For acetylene cylinders, with the agreement of the competent authority, the date of the most recent periodic inspection and the stamp of the body performing the periodic inspection and test may be engraved on a ring held on the cylinder by the valve. The ring shall be configured so that it can only be removed by disconnecting the valve from the cylinder.

6.2.2.8 Marking of non-refillable UN pressure receptacles

Non-refillable UN pressure receptacles shall be marked clearly and legibly with certification and gas or pressure receptacle specific marks. These marks shall be permanently affixed (e.g. stencilled, stamped, engraved, or etched) on the pressure receptacle. Except when stencilled, the marks shall be on the shoulder, top end or neck of the pressure receptacle or on a permanently affixed component of the pressure receptacle (e.g. welded collar). Except for the UN packaging symbol and the "DO NOT REFILL" mark, the minimum size of the marks shall be 5 mm for pressure receptacles with a diameter greater than or equal to 140 mm and 2.5 mm for pressure receptacles with a diameter less than 140 mm. The minimum size of the UN packaging symbol shall be 10 mm for pressure receptacles with a diameter greater than or equal to 140 mm and 5 mm for pressure receptacles with a diameter less than 140 mm. The minimum size of the "DO NOT REFILL" mark shall be 5 mm.

6.2.2.8.1 The marks listed in 6.2.2.7.1 to 6.2.2.7.3 shall be applied with the exception of (g), (h) and (m). The serial number (o) may be replaced by the batch number. In addition, the words "DO NOT REFILL" in letters of at least 5 mm in height are required.

6.2.2.8.2 The requirements of 6.2.2.7.4 shall apply.

NOTE: Non-refillable pressure receptacles may, on account of their size, substitute this marking by a label.

6.2.2.8.3 Other marks are allowed provided they are made in low stress areas other than the side wall and are not of a size and depth that will create harmful stress concentrations. Such marks shall not conflict with required marks.

6.2.2.9 Equivalent procedures for conformity assessment and periodic inspection and test

For UN pressure receptacles the requirements of 6.2.2.5 and 6.2.2.6 are considered to have been complied with when the following procedures are applied:

Procedure	Relevant body
Type approval (1.8.7.2)	Xa
Supervision of manufacture (1.8.7.3)	Xa or IS
Initial inspection and tests (1.8.7.4)	Xa or IS
Periodic inspection (1.8.7.5)	Xa or Xb or IS

Xa means the competent authority, its delegate or inspection body conforming to 1.8.6.4 and accredited according to EN ISO/IEC 17020: 2004 type A.

Xb means inspection body conforming to 1.8.6.4 and accredited according to EN ISO/IEC 17020: 2004 type B.

IS means an in-house inspection service of the applicant under the surveillance of an inspection body conforming to 1.8.6.4 and accredited according to EN ISO/IEC 17020:2004 type A. The in-house inspection service shall be independent from design process, manufacturing operations, repair and maintenance.

[Ref. doc.: ECE/TRANS/WP.15/AC.1/2007/44 + ECE/TRANS/WP.15/AC.1/2007/46 + INF.4 JM 09/07 + INF.50 JM 09/07]

6.2.3 General requirements for non-UN pressure receptacles

6.2.3.1 Design and construction

6.2.3.1.1 Pressure receptacles and their closures not designed, constructed, inspected, tested and approved according to the requirements of 6.2.2 shall be designed, constructed, inspected, tested and approved in accordance with the general requirements of 6.2.1 as supplemented or modified by the requirements of this section and those of 6.2.4 or 6.2.5.

6.2.3.1.2 Whenever possible the wall thickness shall be determined by calculation, accompanied, if needed, by experimental stress analysis. Otherwise the wall thickness may be determined by experimental means.

Appropriate design calculations for the pressure envelope and supporting components shall be used to ensure the safety of the pressure receptacles concerned.

The minimum wall thickness to withstand pressure shall be calculated in particular with regard to:

- the calculation pressures, which shall not be less than the test pressure;
- the calculation temperatures allowing for appropriate safety margins;
- the maximum stresses and peak stress concentrations where necessary;
- factors inherent to the properties of the material.

6.2.3.1.3 For welded pressure receptacles, only metals of weldable quality whose adequate impact strength at an ambient temperature of -20 °C can be guaranteed shall be used.

6.2.3.1.4 For closed cryogenic receptacles, the impact strength to be established as required by 6.2.1.1.8.1 shall be tested as laid down in 6.8.5.3.

6.2.3.2 (Reserved)

6.2.3.3 Service equipment

6.2.3.3.1 Service equipment shall comply with 6.2.1.3.

6.2.3.3.2 Openings

Pressure drums may be provided with openings for filling and discharge and with other openings intended for level gauges, pressure gauges or relief devices. The number of openings shall be kept to a minimum consistent with safe operations. Pressure drums may also be provided with an inspection opening, which shall be closed by an effective closure.

6.2.3.3.3 Fittings

- (a) If cylinders are fitted with a device to prevent rolling, this device shall not be integral with the valve cap;
- (b) Pressure drums which are capable of being rolled shall be equipped with rolling hoops or be otherwise protected against damage due to rolling (e.g. by corrosion resistant metal sprayed on to the pressure receptacle surface);
- (c) Bundles of cylinders shall be fitted with appropriate devices ensuring that they can be handled and carried safely;
- (d) If level gauges, pressure gauges or relief devices are installed, they shall be protected in the same way as is required for valves in 4.1.6.8.

6.2.3.4 Initial inspection and test

6.2.3.4.1

New pressure receptacles shall be subjected to testing and inspection during and after manufacture in accordance with the requirements of 6.2.1.5 except that 6.2.1.5.1 (g) shall be replaced by the following:

- (g) A hydraulic pressure test. Pressure receptacles shall withstand the test pressure without undergoing permanent deformation or exhibiting cracks.

6.2.3.4.2

Specific provisions applying to aluminium alloy pressure receptacles

- (a) In addition to the initial inspection required by 6.2.1.5.1, it is necessary to test for possible intercrystalline corrosion of the inside wall of the pressure receptacles where use is made of an aluminium alloy containing copper, or where use is made of an aluminium alloy containing magnesium and manganese and the magnesium content is greater than 3.5% or the manganese content lower than 0.5%;
- (b) In the case of an aluminium/copper alloy the test shall be carried out by the manufacturer at the time of approval of a new alloy by the competent authority; it shall thereafter be repeated in the course of production, for each pour of the alloy;
- (c) In the case of an aluminium/magnesium alloy the test shall be carried out by the manufacturer at the time of approval of a new alloy and of the manufacturing process by the competent authority. The test shall be repeated whenever a change is made in the composition of the alloy or in the manufacturing process.

6.2.3.5 Periodic inspection and test

6.2.3.5.1 Periodic inspection and test shall be in accordance with 6.2.1.6.1.

NOTE: With the agreement of the competent authority of the country that issued the type approval, the hydraulic pressure test of each welded steel cylinder intended for the carriage of gases of UN No. 1965, hydrocarbon gas mixture liquefied, n.o.s., with a capacity below 6.5 l may be replaced by another test ensuring an equivalent level of safety.

[Consequential amendment; Ref. doc.: INF.21 JM 09/07]

6.2.3.5.2 Closed cryogenic receptacles shall be subjected to periodic inspections and tests by a body authorised by the competent authority in accordance with the periodicity defined in packing instruction P203 of 4.1.4.1 to verify external conditions, condition and operation of pressure relief devices and be subjected to a leakproofness test at 90% of the maximum working pressure. The leakproofness test shall be carried out with the gas contained in the pressure receptacle or with an inert gas. Checking shall be performed by means of a pressure gauge or by vacuum measurement. The thermal insulation need not be removed.

6.2.3.6 Approval of pressure receptacles

6.2.3.6.1 The procedures for conformity assessment and periodic inspection of section 1.8.7 shall be performed by the relevant body according to the following Table.

Procedure	Relevant body
Type approval (1.8.7.2)	Xa
Supervision of manufacture (1.8.7.3)	Xa or IS
Initial inspection and tests (1.8.7.4)	Xa or IS
Periodic inspection (1.8.7.5)	Xa or Xb or IS

The conformity assessment of valves and other accessories having a direct safety function may be carried out separately from the receptacles and the conformity assessment procedure shall be at least as stringent as that undergone by the pressure receptacle to which they are fitted.

Xa means the competent authority, its delegate or inspection body conforming to 1.8.6.4 and accredited according to EN ISO/IEC 17020:2004 type A.

Xb means inspection body conforming to 1.8.6.4 and accredited according to EN ISO/IEC 17020:2004 type B.

IS means an in-house inspection service of the applicant under the surveillance of an inspection body conforming to 1.8.6.4 and accredited according to EN ISO/IEC 17020:2004 type A. The in-house inspection service shall be independent from design process, manufacturing operations, repair and maintenance.

[Ref. doc.: ECE/TRANS/WP.15/AC.1/2007/44 + ECE/TRANS/WP.15/AC.1/2007/46 + INF.4 JM 09/07 + INF.50 JM 09/07]

6.2.3.6.2 6.2.1.7.2 shall not apply in the case of pressure receptacles with a test pressure capacity product (PH·V) of not more than 300 bar·litres.

6.2.3.7 Requirements for manufacturers

6.2.3.7.1 The relevant requirements of 1.8.7 shall be met.

6.2.3.8 Requirements for inspection bodies

The requirements of 1.8.6 shall be met.

6.2.3.9 Marking of refillable pressure receptacles

6.2.3.9.1 Markings shall be in accordance with sub-section 6.2.2.7 with the following variations.

6.2.3.9.2 The United Nations packaging symbol specified in 6.2.2.7.1 (a) shall not be applied.

6.2.3.9.3 The requirements of 6.2.2.7.1 (j) shall be replaced by the following:

The water capacity of the pressure receptacle in litres followed by the letter "L". In the case of pressure receptacles for liquefied gases the water capacity in litres shall be expressed to three significant figures rounded down to the last digit. If the value of the minimum or nominal water capacity is an integer, the figures after the decimal point may be neglected.

6.2.3.9.4 The marks specified in 6.2.2.7.2 (g) and (h) and 6.2.2.7.3 (m) are not required for pressure receptacles for UN No. 1965 hydrocarbon gas mixture, liquefied, n.o.s.

6.2.3.9.5 When marking the date required by 6.2.2.7.6 (c), the month need not be indicated for gases for which the interval between periodic inspections is 10 years or more (see packing instructions P200 and P203 of 4.1.4.1).

6.2.3.9.6 The date of the most recent periodic inspection and the stamp of the inspection body may be engraved on a ring of an appropriate material affixed to the cylinder when the valve is installed and which is removable only by disconnecting the valve from the cylinder.

6.2.3.10 Marking of non-refillable pressure receptacles

6.2.3.10.1 Markings shall be in accordance with 6.2.2.8, except that the United Nations packaging symbol specified in 6.2.2.7.1 (a) shall not be applied.

6.2.4 Requirements for non-UN pressure receptacles designed, constructed and tested according to standards

Die Anforderungen der Abschnitte 6.2.1 und 6.2.3 gelten bei Anwendung der jeweiligen nachstehenden Norm als erfüllt:

NOTE: Persons or bodies identified in standards as having responsibilities in accordance with RID shall meet the requirements of RID.

Depending on the date of construction of the pressure receptacle, the standards listed in the Table below shall be applied as indicated in column (4) to meet the requirements of Chapter 6.2 referred to in column (3) or may be applied as indicated in column (5). The requirements of Chapter 6.2 referred to in column (3) shall prevail in all cases.

If more than one standard is listed as mandatory for the application of the same requirements, only one of them shall be applied, but in full unless otherwise specified in the Table below.

Reference	Title of document	Applicable sub-sections and paragraphs	Mandatory application for pressure receptacles constructed	Application authorized for pressure receptacles constructed
(1)	(2)	(3)	(4)	(5)
<i>for materials</i>				
EN 1797-1:1998	Cryogenic vessels – Gas/material compatibility	6.2.1.2		Between 1 July 2001 and 30 June 2003
EN 1797:2001	Cryogenic vessels – Gas/material compatibility	6.2.1.2	As from 1 January 2009	Before 1 January 2009
EN ISO 11114-1:1997	Transportable gas cylinders – Compatibility of cylinder and valve materials with gas contents – Part 1: Metallic materials	6.2.1.2	As from 1 January 2009	Before 1 January 2009
EN ISO 11114-2:2000	Transportable gas cylinders – Compatibility of cylinder and valve materials with gas contents – Part 2: Non-metallic materials	6.2.1.2	As from 1 January 2009	Before 1 January 2009
EN ISO 11114-4:2005 (except method C in 5.3)	Transportable gas cylinders – Compatibility of cylinder and valve materials with gas contents – Part 4: Test methods for selecting metallic materials resistant to hydrogen embrittlement	6.2.1.2	As from 1 January 2009	Before 1 January 2009
EN 1252-1:1998	Cryogenic vessels – Materials – Part 1: Toughness requirements for temperature below -80 °C	6.2.1.2		Between 1 July 2001 and 30 June 2003
<i>[for marking</i>				
EN 1442:1998	Transportable refillable welded steel cylinders for liquefied petroleum gas (LPG) – Design and construction	6.2.2.7		Before 1 July 2003
EN 1251-1:2000	Cryogenic vessels – Transportable, vacuum insulated, of not more than 1 000 litres volume – Part 1: Fundamental requirements	6.2.2.7		Before 1 July 2003
EN 1089-1:1996	Transportable gas cylinders – Gas cylinder identification (excluding LPG) – Part 1: Stamp-marking	6.2.2.7		Before 1 July 2003]

Reference	Title of document	Applicable sub-sections and paragraphs	Mandatory application for pressure receptacles constructed	Application authorized for pressure receptacles constructed
(1)	(2)	(3)	(4)	(5)
for design and construction				
Annex I, Parts 1 to 3 to 84/525/EEC	Council directive on the approximation of the laws of the Member States relating to seamless steel gas cylinders, published in the Official Journal of the European Communities No. L 300 from 19.11.1984.	6.2.3.1 and 6.2.3.4	As from 1 January 2009	Before 1 January 2009
Annex I, Parts 1 to 3 to 84/526/EEC	Council directive on the approximation of the laws of the Member States relating to seamless, unalloyed aluminium and aluminium alloy gas cylinders, published in the Official Journal of the European Communities No. L 300 from 19.11.1984.	6.2.3.1 and 6.2.3.4	As from 1 January 2009	Before 1 January 2009
Annex I, Parts 1 to 3 to 84/527/EEC	Council directive on the approximation of the laws of the Member States relating to welded unalloyed steel gas cylinders, published in the Official Journal of the European Communities No. L 300 from 19.11.1984.	6.2.3.1 and 6.2.3.4	As from 1 January 2009	Before 1 January 2009
EN 1442:1998	Transportable refillable welded steel cylinders for liquefied petroleum gas (LPG) – Design and construction	6.2.3.1 and 6.2.3.4		Between 1 July 2001 and 30 June 2007
EN 1442:1998 + A2:2005	Transportable refillable welded steel cylinders for liquefied petroleum gas (LPG) – Design and construction	6.2.3.1 and 6.2.3.4	Between 1 January 2009 and 31 December 2010 ⁷	Before 1 January 2009
EN 1442:2006 + A1:2007	Transportable refillable welded steel cylinders for liquefied petroleum gas (LPG) – Design and construction	6.2.3.1 and 6.2.3.4	As from 1 January 2011	Before 1 January 2011
EN 1800:1998 + AC:1999	Transportable gas cylinders – Acetylene cylinders – Basic requirements and definitions	6.2.1.1.9	Between 1 January 2009 and 31 December 2010 ⁷	Before 1 January 2009
EN 1800:2006	Transportable gas cylinders – Acetylene cylinders – Basic requirements, definitions and type testing	6.2.1.1.9	As from 1 January 2011	Before 1 January 2011
EN 1964-1:1999	Transportable gas cylinders – Specifications for the design and construction of refillable transportable seamless steel gas cylinders of capacity from 0.5 litres up to 150 litres – Part 1: Cylinders made of seamless steel with a Rm value of less than 1 100 MPa	6.2.3.1 and 6.2.3.4	As from 1 January 2009	Before 1 January 2009

⁷ Unless the application of another standard is authorized in column (5) for the same purposes for pressure receptacles constructed at the same date.

Reference	Title of document	Applicable sub-sections and paragraphs	Mandatory application for pressure receptacles constructed	Application authorized for pressure receptacles constructed
(1)	(2)	(3)	(4)	(5)
EN 1975:1999 (except Annex 6)	Transportable gas cylinders – Specifications for the design and construction of refillable transportable seamless aluminium and aluminium alloy gas cylinders of capacity from 0.5 litres up to 150 litres	6.2.3.1 and 6.2.3.4		Before 1 July 2005
EN 1975:1999 + A1:2003	Transportable gas cylinders – Specifications for the design and construction of refillable transportable seamless aluminium and aluminium alloy gas cylinders of capacity from 0.5 litres up to 150 litres	6.2.3.1 and 6.2.3.4	As from 1 January 2009	Before 1 January 2009
EN ISO 11120:1999	Gas cylinders – Refillable seamless steel tubes for compressed gas transport of water capacity between 150 litres and 3 000 litres – Design, construction and testing	6.2.3.1 and 6.2.3.4	As from 1 January 2009	Before 1 January 2009
EN 1964-3: 2000	Transportable gas cylinders – Specifications for the design and construction of refillable transportable seamless steel gas cylinders of capacity from 0.5 litre up to 150 litres – Part 3: Cylinders made of stainless steel	6.2.3.1 and 6.2.3.4	As from 1 January 2009	Before 1 January 2009
EN 12862: 2000	Transportable gas cylinders – Specifications for the design and construction of refillable transportable welded aluminium alloy gas cylinders	6.2.3.1 and 6.2.3.4	As from 1 January 2009	Before 1 January 2009
EN 1251-2:2000	Cryogenic vessels – Transportable, vacuum insulated, of not more than 1 000 litres volume – Part 2: Design, fabrication, inspection and testing	6.2.3.1 and 6.2.3.4	As from 1 January 2009	Before 1 January 2009
EN 12257:2002	Transportable gas cylinders – Seamless, hoop wrapped composite cylinders	6.2.3.1 and 6.2.3.4	As from 1 January 2009	Before 1 January 2009
EN 12807:2001 (except Annex A)	Transportable refillable brazed steel cylinders for liquefied petroleum gas (LPG) – Design and construction	6.2.3.1 and 6.2.3.4	As from 1 January 2009	Before 1 January 2009
EN 1964-2:2001	Transportable gas cylinders – Specification for the design and construction of refillable transportable seamless steel gas cylinders of water capacities from 0.5 litre up to and including 150 litre – Part 2: Cylinders made of seamless steel with a $R_m \geq 1100$ MPa	6.2.3.1 and 6.2.3.4	As from 1 January 2009	Before 1 January 2009

Reference	Title of document	Applicable sub-sections and paragraphs	Mandatory application for pressure receptacles constructed	Application authorized for pressure receptacles constructed
(1)	(2)	(3)	(4)	(5)
EN 13293:2002	Transportable gas cylinders – Specification for the design and construction of refillable transportable seamless normalised carbon manganese steel gas cylinders of water capacity up to 0.5 litre for compressed, liquefied and dissolved gases and up to 1 litre for carbon dioxide	6.2.3.1 and 6.2.3.4	As from 1 January 2009	Before 1 January 2009
EN 13322-1:2003	Transportable gas cylinders – Refillable welded steel gas cylinders – Design and construction – Part 1: Welded steel	6.2.3.1 and 6.2.3.4		Before 1 July 2007
EN 13322-1:2003 + A1:2006	Transportable gas cylinders – Refillable welded steel gas cylinders – Design and construction – Part 1: Welded steel	6.2.3.1 and 6.2.3.4	As from 1 January 2009	Before 1 January 2009
EN 13322-2:2003	Transportable gas cylinders – Refillable welded stainless steel gas cylinders – Design and construction – Part 2: Welded stainless steel	6.2.3.1 and 6.2.3.4		Before 1 July 2007
EN 13322-2:2003 + A1:2006	Transportable gas cylinders – Refillable welded stainless steel gas cylinders – Design and construction – Part 2: Welded stainless steel	6.2.3.1 and 6.2.3.4	As from 1 January 2009	Before 1 January 2009
EN 12245:2002	Transportable gas cylinders – Fully wrapped composite cylinders	6.2.3.1 and 6.2.3.4	As from 1 January 2009	Before 1 January 2009
EN 12205:2001	Transportable gas cylinders – Non refillable metallic gas cylinders	6.2.3.1, 6.2.3.4 and 6.2.3.9	As from 1 January 2009	Before 1 January 2009
EN 13110:2002	Transportable refillable welded aluminium cylinders for liquefied petroleum gas (LPG) – Design and construction	6.2.3.1, 6.2.3.4 and 6.2.3.9	As from 1 January 2009	Before 1 January 2009
EN 14427:2004	Transportable refillable fully wrapped composite cylinders for liquefied petroleum gases – Design and construction NOTE: This standard applies only to cylinders equipped with pressure relief valves.	6.2.3.1, 6.2.3.4 and 6.2.3.9		Before 1 July 2007
EN 14427:2004 + A1:2005	Transportable refillable fully wrapped composite cylinders for liquefied petroleum gases – Design and construction NOTE 1: This standard applies only to cylinders equipped with pressure relief valves. 2: In 5.2.9.2.1 and 5.2.9.3.1, both cylinders shall be subject to the burst test when they show damage equal to or worse than the rejection criteria.	6.2.3.1, 6.2.3.4 and 6.2.3.9	As from 1 January 2009	Before 1 January 2009

Reference	Title of document	Applicable sub-sections and paragraphs	Mandatory application for pressure receptacles constructed	Application authorized for pressure receptacles constructed
(1)	(2)	(3)	(4)	(5)
EN 14208:2004	Transportable gas cylinders – Specification for welded pressure drums up to 1000 litres capacity for the transport of gases – Design and construction	6.2.3.1, 6.2.3.4 and 6.2.3.9	As from 1 January 2009	Before 1 January 2009
EN 14140:2003	Transportable refillable welded steel cylinders for Liquefied Petroleum Gas (LPG) – Alternative design and construction	6.2.3.1, 6.2.3.4 and 6.2.3.9	Between 1 January 2009 and 31 December 2010 ⁷	Before 1 January 2009
EN 14140:2003 + A1:2006 (with the exemption of the Note to Annex A [if not deleted when published])	LPG equipment and accessories – Transportable refillable welded steel cylinders for LPG – Alternative design and construction	6.2.3.1, 6.2.3.4 and 6.2.3.9	As from 1 January 2011	Before 1 January 2011
EN 13769:2003	Transportable gas cylinders – Cylinder bundles – Design, manufacture, identification and testing	6.2.3.1, 6.2.3.4 and 6.2.3.9		Before 1 July 2007
EN 13769:2003 + A1:2005	Transportable gas cylinders – Cylinder bundles – Design, manufacture, identification and testing	6.2.3.1, 6.2.3.4 and 6.2.3.9	As from 1 January 2009	Before 1 January 2009
EN 14638-1:2006	Transportable gas cylinders – Refillable welded receptacles of a capacity not exceeding 150 litres – Part 1: Welded austenitic stainless steel cylinders made to a design justified by experimental methods	6.2.3.1 and 6.2.3.4	As from 1 January 2011	Before 1 January 2011
EN 14893:2006 [+ AC:2007]	LPG equipment and accessories – Transportable LPG welded steel pressure drums with a capacity between 150 litres and 1 000 litres	6.2.3.1 and 6.2.3.4	As from 1 January 2011	Before 1 January 2011
for closures				
EN 849:1996 (except Annex A)	Transportable gas cylinders – Cylinder valves: Specification and type testing	6.2.3.1		Before 1 July 2003
EN 849:1996/A2:2001	Transportable gas cylinders – Cylinder valves: Specification and type testing	6.2.3.1		Before 1 July 2007
EN ISO 10297: 2006	Transportable gas cylinders – Cylinder valves: Specification and type testing	6.2.3.1	As from 1 January 2009	Before 1 January 2009
EN 13152:2001	Specifications and testing of LPG – cylinder valves – Self closing	6.2.3.1	As from 1 January 2009	Before 1 January 2009
EN 13153:2001	Specifications and testing of LPG – cylinder valves – Manually operated	6.2.3.1	As from 1 January 2009	Before 1 January 2009
for periodic inspection and test				
EN 1251-3: 2000	Cryogenic vessels – Transportable, vacuum insulated, of not more than 1 000 litres volume – Part 3: Operational requirements	6.2.3.5	As from 1 January 2009	Before 1 January 2009
EN 1968:2002 (except Annex B)	Transportable gas cylinders – Periodic inspection and testing of seamless steel gas cylinders	6.2.3.5		Before 1 July 2007

Reference	Title of document	Applicable sub-sections and paragraphs	Mandatory application for pressure receptacles constructed	Application authorized for pressure receptacles constructed
(1)	(2)	(3)	(4)	(5)
EN 1968:2002 + A1:2005 (except Annex B)	Transportable gas cylinders – Periodic inspection and testing of seamless steel gas cylinders	6.2.3.5	As from 1 January 2009	Before 1 January 2009
EN 1802:2002 (except Annex B)	Transportable gas cylinders – Periodic inspection and testing of seamless aluminium alloy gas cylinders	6.2.3.5	As from 1 January 2009	Before 1 January 2009
EN 12863:2002	Transportable gas cylinders – Periodic inspection and maintenance of dissolved acetylene cylinders NOTE: In this standard "initial inspection" is to be understood as the "first periodic inspection" after final approval of a new acetylene cylinder.	6.2.3.5		Before 1 July 2007
EN 12863:2002 + A1:2005	Transportable gas cylinders – Periodic inspection and maintenance of dissolved acetylene cylinders NOTE: In this standard "initial inspection" is to be understood as the "first periodic inspection" after final approval of a new acetylene cylinder.	6.2.3.5	As from 1 January 2009	Before 1 January 2009
EN 1803:2002 (except Annex B)	Transportable gas cylinders – Periodic inspection and testing of welded steel gas cylinders	6.2.3.5	As from 1 January 2009	Before 1 January 2009
EN ISO 11623:2002 (except clause 4)	Transportable gas cylinders – Periodic inspection and testing of composite gas cylinders	6.2.3.5	As from 1 January 2009	Before 1 January 2009
EN 14189:2003	Transportable gas cylinders – Inspection and maintenance of cylinder valves at time of periodic inspection of gas cylinders	6.2.3.5	As from 1 January 2009	Before 1 January 2009
EN 14876:2007	Transportable gas cylinders – Periodic inspection and testing of welded steel pressure drums	6.2.3.5	As from 1 January 2011	Before 1 January 2011
EN 14912:2005	LPG equipment and accessories – Inspection and maintenance of LPG cylinder valves at time of periodic inspection of cylinders	6.2.3.5	As from 1 January 2011	Before 1 January 2011

[Ref. doc.: INF.44/Rev.1 JM 09/07 as amended + INF.51 JM 09/07]

6.2.5 Requirements for non-UN pressure receptacles not designed, constructed and tested according to standards

To reflect scientific and technical progress or where no standard is listed in 6.2.2 or 6.2.4, or to deal with specific aspects not addressed in a standard listed in 6.2.2 or 6.2.4, the competent authority may recognize the use of a technical code providing the same level of safety.

The competent authority shall transmit to the secretariat of OTIF a list of the technical codes that it recognises. The list should include the following details: name and

date of the code, purpose of the code and details of where it may be obtained. The secretariat shall make this information publicly available on its web-site.

The requirements of 6.2.1, 6.2.3 and the following requirements however shall be met.

NOTE: For this section, the references to technical standards in 6.2.1 shall be considered as references to technical codes.

[Ref. doc.: ECE/TRANS/WP.15/AC.1/2007/52]

6.2.5.1 Materials

The following provisions contain examples of materials that may be used to comply with the requirements for materials in 6.2.1.2:

- (a) Carbon steel for compressed, liquefied, refrigerated liquefied gases and dissolved gases as well as for substances not in Class 2 listed in Table 3 of packing instruction P200 of 4.1.4.1;
- (b) Alloy steel (special steels), nickel, nickel alloy (such as monel) for compressed, liquefied, refrigerated liquefied gases and dissolved gases as well as for substances not in Class 2 listed in Table 3 of packing instruction P200 of 4.1.4.1;
- (c) Copper for:
 - (i) gases of classification codes 1A, 1O, 1F and 1TF, whose filling pressure referred to a temperature of 15 °C does not exceed 2 MPa (20 bar);
 - (ii) gases of classification code 2A and also UN No. 1033 dimethyl ether; UN No. 1037 ethyl chloride; UN No. 1063 methyl chloride; UN No. 1079 sulphur dioxide; UN No. 1085 vinyl bromide; UN No. 1086 vinyl chloride; and UN No. 3300 ethylene oxide and carbon dioxide mixture with more than 87% ethylene oxide;
 - (iii) gases of classification codes 3A, 3O and 3F;
- (d) Aluminium alloy: see special requirement "a" of packing instruction P200 (10) of 4.1.4.1;
- (e) Composite material for compressed, liquefied, refrigerated liquefied gases and dissolved gases;
- (f) Synthetic materials for refrigerated liquefied gases; and
- (g) Glass for the refrigerated liquefied gases of classification code 3A other than UN No. 2187 carbon dioxide, refrigerated, liquid or mixtures thereof, and gases of classification code 3O.

6.2.5.2 Service equipment

(Reserved)

6.2.5.3 Metal cylinders, tubes, pressure drums and bundles of cylinders

At the test pressure, the stress in the metal at the most severely stressed point of the pressure receptacle shall not exceed 77% of the guaranteed minimum yield stress (Re).

"Yield stress" means the stress at which a permanent elongation of 2 per thousand (i.e. 0.2%) or, for austenitic steels, 1% of the gauge length on the test-piece, has been produced.

NOTE: In the case of sheet-metal the axis of the tensile test-piece shall be at right angles to the direction of rolling. The permanent elongation at fracture, shall be measured on a test-piece of circular cross-section in which the gauge length "l" is equal to five times the diameter "d" ($l = 5d$); if test pieces of rectangular cross-section are used, the gauge length "l" shall be calculated by the formula:

$$l = 5.65 \sqrt{F_0}$$

where F_0 indicates the initial cross-sectional area of the test-piece.

Pressure receptacles and their closures shall be made of suitable materials which shall be resistant to brittle fracture and to stress corrosion cracking between $-20\text{ }^{\circ}\text{C}$ and $+50\text{ }^{\circ}\text{C}$.

Welds shall be skilfully made and shall afford the fullest safety.

6.2.5.4 Additional provisions relating to aluminium-alloy pressure receptacles for compressed gases, liquefied gases, dissolved gases and non pressurized gases subject to special requirements (gas samples) as well as articles containing gas under pressure other than aerosol dispensers and small receptacles containing gas (gas cartridges)

6.2.5.4.1 The materials of aluminium-alloy pressure receptacles which are to be accepted shall satisfy the following requirements:

	A	B	C	D
Tensile strength, Rm, in MPa (= N/mm ²)	49 to 186	196 to 372	196 to 372	343 to 490
Yield stress, Re, in MPa (= N/mm ²) (permanent set λ = 0.2%)	10 to 167	59 to 314	137 to 334	206 to 412
Permanent elongation at fracture (l = 5d) in per cent	12 to 40	12 to 30	12 to 30	11 to 16
Bend test (diameter of former d = n × e, where e is the thickness of the test piece)	n = 5 (Rm ≤ 98) n = 6 (Rm > 98)	n = 6 (Rm ≤ 325) n = 7 (Rm > 325)	n = 6 (Rm ≤ 325) n = 7 (Rm > 325)	n = 7 (Rm ≤ 392) n = 8 (Rm > 392)
Aluminium Association Series Number ^(a)	1000	5000	6000	2000

^(a) See "Aluminium Standards and Data", Fifth edition, January 1976, published by the Aluminium Association, 750 Third Avenue, New York.

The actual properties will depend on the composition of the alloy concerned and on the final treatment of the pressure receptacle, but whatever alloy is used the thickness of the pressure receptacle shall be calculated by one of the following formulae:

$$e = \frac{P_{\text{MPa}} \times D}{\frac{2 \times R_e}{1.30} + P_{\text{MPa}}} \quad \text{or} \quad e = \frac{P_{\text{bar}} \times D}{\frac{20 \times R_e}{1.30} + P_{\text{bar}}}$$

where

e = minimum thickness of pressure receptacle wall, in mm

P_{MPa} = test pressure, in MPa

P_{bar} = test pressure, in bar

D = nominal external diameter of the pressure receptacle, in mm

and

R_e = guaranteed minimum proof stress with 0.2% proof stress, in Mpa (= N/mm²)

In addition, the value of the minimum guaranteed proof stress (R_e) introduced into the formula is in no case to be greater than 0.85 times the guaranteed minimum tensile strength (R_m), whatever the type of alloy used.

NOTE 1: The above characteristics are based on previous experience with the following materials used for pressure receptacles:

Column A: Aluminium, unalloyed, 99.5 g pure;

Column B: Alloys of aluminium and magnesium;

Column C: Alloys of aluminium, silicon and magnesium, such as ISO/R209-Al-Si-Mg (Aluminium Association 6351);

Column D: Alloys of aluminium, copper and magnesium.

2: The permanent elongation at fracture is measured by means of test-pieces of circular cross-section in which the gauge length "l" is equal to five times the diameter "d" (l = 5d); if test-pieces of rectangular section are used the gauge length shall be calculated by the formula:

$$l = 5.65 \sqrt{F_0}$$

where F₀ is the initial cross-section area of the test-piece.

3: (a) The bend test (see diagram) shall be carried out on specimens obtained by cutting into two equal parts of width 3e, but in no case less

than 25 mm, an annular section of a cylinder. The specimens shall not be machined elsewhere than on the edges;

- (b) The bend test shall be carried out between a mandrel of diameter (d) and two circular supports separated by a distance of $(d + 3e)$. During the test the inner faces shall be separated by a distance not greater than the diameter of the mandrel;
- (c) The specimen shall not exhibit cracks when it has been bent inwards around the mandrel until the inner faces are separated by a distance not greater than the diameter of the mandrel;
- (d) The ratio (n) between the diameter of the mandrel and the thickness of the specimen shall conform to the values given in the Table.

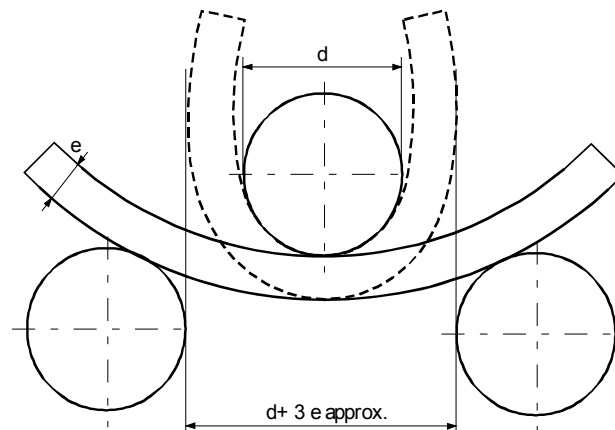

Diagram of bend test

- 6.2.5.4.2** A lower minimum elongation value is acceptable on condition that an additional test approved by the competent authority of the country in which the pressure receptacles are made proves that safety of carriage is ensured to the same extent as in the case of pressure receptacles constructed to comply with the characteristics given in the Table in 6.2.5.4.1 (see also EN 1975:1999 + A1:2003).
- 6.2.5.4.3** The wall thickness of the pressure receptacles at the thinnest point shall be the following:
 - where the diameter of the pressure receptacle is less than 50 mm: not less than 1.5 mm;
 - where the diameter of the pressure receptacle is from 50 to 150 mm: not less than 2 mm; and
 - where the diameter of the pressure receptacle is more than 150 mm: not less than 3 mm.
- 6.2.5.4.4** The ends of the pressure receptacles shall have a semicircular, elliptical or "basket-handle" section; they shall afford the same degree of safety as the body of the pressure receptacle.

6.2.5.5 Pressure receptacles in composite materials

For composite cylinders, tubes, pressure drums and bundles of cylinders which make use of composite materials, the construction shall be such that a minimum burst ratio (burst pressure divided by test pressure) is:

- 1.67 for hoop wrapped pressure receptacles;
- 2.00 for fully wrapped pressure receptacles.

6.2.5.6 Closed cryogenic receptacles

The following requirements apply to the construction of closed cryogenic receptacles for refrigerated liquefied gases:

6.2.5.6.1 If non-metallic materials are used, they shall resist brittle fracture at the lowest working temperature of the pressure receptacle and its fittings.

6.2.5.6.2 The pressure relief devices shall be so constructed as to work perfectly even at their lowest working temperature. Their reliability of functioning at that temperature shall be established and checked by testing each device or a sample of devices of the same type of construction.

6.2.5.6.3 The vents and pressure relief devices of pressure receptacles shall be so designed as to prevent the liquid from splashing out.

6.2.6 General requirements for aerosol dispensers, small receptacles containing gas (gas cartridges) and fuel cell cartridges containing liquefied flammable gas

[Ref. doc.: ST/SG/AC.10/C.3/2006/82]

6.2.6.1 Design and construction

6.2.6.1.1 Aerosol dispensers (UN No. 1950 aerosols) containing only a gas or a mixture of gases, and small receptacles containing gas (gas cartridges) (UN No. 2037), shall be made of metal. This requirement shall not apply to aerosols and small receptacles containing gas (gas cartridges) with a maximum capacity of 100 ml for UN No. 1011 butane. Other aerosol dispensers (UN No. 1950 aerosols) shall be made of metal, synthetic material or glass. Receptacles made of metal and having an outside diameter of not less than 40 mm shall have a concave bottom.

6.2.6.1.2 The capacity of receptacles made of metal shall not exceed 1 000 ml; that of receptacles made of synthetic material or of glass shall not exceed 500 ml.

6.2.6.1.3 Each model of receptacles (aerosol dispensers or cartridges) shall, before being put into service, satisfy a hydraulic pressure test carried out in conformity with 6.2.6.2.

6.2.6.1.4 The release valves and dispersal devices of aerosol dispensers (UN No. 1950 aerosols) and the valves of UN No. 2037 small receptacles containing gas (gas cartridges) shall ensure that the receptacles are so closed as to be leakproof and shall be protected against accidental opening. Valves and dispersal devices which close only by the action of the internal pressure are not to be accepted.

6.2.6.1.5 The internal pressure at 50 °C shall exceed neither two-thirds of the test pressure nor 1.32 MPa (13.2 bar). Aerosol dispensers and small receptacles containing gas (gas cartridges) shall be so filled that at 50 °C the liquid phase does not exceed 95% of their capacity.

6.2.6.2 Hydraulic pressure test

6.2.6.2.1 The internal pressure to be applied (test pressure) shall be 1.5 times the internal pressure at 50 °C, with a minimum pressure of 1 MPa (10 bar).

6.2.6.2.2 The hydraulic pressure tests shall be carried out on at least five empty receptacles of each model:

- (a) until the prescribed test pressure is reached, by which time no leakage or visible permanent deformation shall have occurred; and
- (b) until leakage or bursting occurs; the dished end, if any, shall yield first and the receptacle shall not leak or burst until a pressure 1.2 times the test pressure has been reached or passed.

6.2.6.3 Tightness (leakproofness) test

6.2.6.3.1 Small receptacles containing gas (gas cartridges) and fuel cell cartridges containing liquefied flammable gas

[Ref. doc.: ST/SG/AC.10/C.3/2006/82]

6.2.6.3.1.1 Each receptacle or fuel cell cartridge shall satisfy a tightness (leakproofness) test in a hot-water bath.

[Ref. doc.: ST/SG/AC.10/C.3/2006/82]

6.2.6.3.1.2 The temperature of the bath and the duration of the test shall be such that the internal pressure of each receptacle or fuel cell cartridge reaches at least 90% of the internal pressure that would be reached at 55 °C. However, if the contents are sensitive to heat or if the receptacles or the fuel cell cartridges are made of a plastics material which softens at this temperature, the temperature of the bath shall be from 20 °C to 30 °C. In addition, one receptacle or fuel cell cartridge out of every 2 000 shall be tested at 55 °C.

[Ref. doc.: ST/SG/AC.10/C.3/2006/82]

6.2.6.3.1.3 No leakage or permanent deformation of a receptacle or fuel cell cartridge shall occur, except that a plastics receptacle or fuel cell cartridge may be deformed through softening provided that it does not leak.

[Ref. doc.: ST/SG/AC.10/C.3/2006/82]

6.2.6.3.2 Aerosol dispensers

Each filled aerosol dispenser shall be subjected to a test performed in a hot water bath or an approved water bath alternative.

6.2.6.3.2.1 Hot water bath test

6.2.6.3.2.1.1 The temperature of the water bath and the duration of the test shall be such that the internal pressure reaches that which would be reached at 55 °C (50 °C if the liquid

phase does not exceed 95% of the capacity of the aerosol dispenser at 50 °C). If the contents are sensitive to heat or if the aerosol dispensers are made of plastics material which softens at this test temperature, the temperature of the bath shall be set at between 20 °C and 30 °C but, in addition, one aerosol dispenser in 2 000 shall be tested at the higher temperature.

6.2.6.3.2.1.2 No leakage or permanent deformation of an aerosol dispenser may occur, except that a plastics aerosol dispenser may be deformed through softening provided that it does not leak.

6.2.6.3.2.2 Alternative methods

With the approval of the competent authority alternative methods which provide an equivalent level of safety may be used provided that the requirements of 6.2.6.3.2.2.1, 6.2.6.3.2.2.2 and 6.2.6.3.2.2.3 are met.

6.2.6.3.2.2.1 Quality system

Aerosol dispenser fillers and component manufacturers shall have a quality system. The quality system shall implement procedures to ensure that all aerosol dispensers that leak or that are deformed are rejected and not offered for carriage.

The quality system shall include:

- (a) a description of the organizational structure and responsibilities;
- (b) the relevant inspection and test, quality control, quality assurance, and process operation instructions that will be used;
- (c) quality records, such as inspection reports, test data, calibration data and certificates;
- (d) management reviews to ensure the effective operation of the quality system;
- (e) a process for control of documents and their revision;
- (f) a means for control of non-conforming aerosol dispensers;
- (g) training programmes and qualification procedures for relevant personnel; and
- (h) procedures to ensure that there is no damage to the final product.

An initial audit and periodic audits shall be conducted to the satisfaction of the competent authority. These audits shall ensure the approved system is and remains adequate and efficient. Any proposed changes to the approved system shall be notified to the competent authority in advance.

6.2.6.3.2.2.2 Pressure and leak testing of aerosol dispensers before filling

Every empty aerosol dispenser shall be subjected to a pressure equal to or in excess of the maximum expected in the filled aerosol dispensers at 55 °C (50 °C if the liquid phase does not exceed 95% of the capacity of the receptacle at 50 °C). This shall be at least two-thirds of the design pressure of the aerosol dispenser. If any aerosol dispenser shows evidence of leakage at a rate equal to or greater than $3.3 \times 10^{-2} \text{ mbar}\cdot\text{l}\cdot\text{s}^{-1}$ at the test pressure, distortion or other defect, it shall be rejected.

6.2.6.3.2.2.3 Testing of the aerosol dispensers after filling

Prior to filling the filler shall ensure that the crimping equipment is set appropriately and the specified propellant is used.

Each filled aerosol dispenser shall be weighed and leak tested. The leak detection equipment shall be sufficiently sensitive to detect at least a leak rate of 2.0×10^{-3} mbar·l·s⁻¹ at 20 °C.

Any filled aerosol dispenser which shows evidence of leakage, deformation or excessive weight shall be rejected.

6.2.6.3.3 With the approval of the competent authority, aerosols and receptacles, small, containing pharmaceutical products and non flammable gases which are required to be sterile, but may be adversely affected by water bath testing, are not subject to 6.2.6.3.1 and 6.2.6.3.2 if:

- (a) They are manufactured under the authority of a national health administration and, if required by the competent authority, follow the principles of Good Manufacturing Practice (GMP) established by the World Health Organization (WHO)⁸; and
- (b) An equivalent level of safety is achieved by the manufacturer's use of alternative methods for leak detection and pressure resistance, such as helium detection and water bathing a statistical sample of at least 1 in 2 000 from each production batch.

6.2.6.4 Reference to standards

The requirements of this section are deemed to be met if the following standards are complied with:

- for aerosol dispensers (UN No. 1950 aerosols): Annex to Council Directive 75/324/EEC⁹ as amended by Commission Directive 94/1/EC¹⁰;
- for UN No. 2037, small recipients containing gas (gas cartridges) containing UN No. 1965, hydrocarbon gas mixture n.o.s, liquefied: EN 417:2003 Non-refillable metallic gas cartridges for liquefied petroleum gases, with or without a valve, for use with portable appliances – Construction, inspection, testing and marking.

[Ref. doc.: ECE/TRANS/WP.15/AC.1/2007/18 as amended]

⁸ WHO Publication: "Quality assurance of pharmaceuticals. A compendium of guidelines and related materials. Volume 2: Good manufacturing practices and inspection".

⁹ Council Directive 75/324/EEC of 20 May 1975 on the approximation of the laws of the Member States relating to aerosol dispensers, published in the Official Journal of the European Communities No. L 147 of 9 June 1975.

¹⁰ Commission Directive 94/1/EC of 6 January 1994, adapting some technicalities of Council Directive 75/324/EEC on the approximation of the laws of the relating Member States to aerosol dispensers published in the Official Journal of the European Communities No. L 23 of 28 January 1994.

Chapter 6.3

In the title, replace "substances" with:

"infectious substances of category A".

6.3.1 to 6.3.3

Amend to read as follows:

"6.3.1 **General**

6.3.1.1 The requirements of this Chapter apply to packagings intended for the carriage of infectious substances of Category A.

6.3.2 Requirements for packagings

6.3.2.1 The requirements for packagings in this section are based on packagings, as specified in 6.1.4, currently used. In order to take into account progress in science and technology, there is no objection to the use of packagings having specifications different from those in this Chapter provided that they are equally effective, acceptable to the competent authority and able successfully to withstand the tests described in 6.3.5. Methods of testing other than those described in RID are acceptable provided they are equivalent, and are recognized by the competent authority.

6.3.2.2 Packagings shall be manufactured and tested under a quality assurance programme which satisfies the competent authority in order to ensure that each packaging meets the requirements of this Chapter.

NOTE: ISO 16106:2006 "Packaging – Transport packages for dangerous goods – Dangerous goods packagings, intermediate bulk containers (IBCs) and large packagings – Guidelines for the application of ISO 9001" provides acceptable guidance on procedures which may be followed.

6.3.2.3 (Text of existing 6.3.1.3)

6.3.3 Code for designating types of packagings

6.3.3.1 The codes for designating types of packagings are set out in 6.1.2.7.

6.3.3.2 The letters "U" or "W" may follow the packaging code. The letter "U" signifies a special packaging conforming to the requirements of 6.3.5.1.6. The letter "W" signifies that the packaging, although, of the same type indicated by the code is manufactured to a specification different from that in 6.1.4 and is considered equivalent under the requirements of 6.3.2.1."

Add new sections 6.3.4 and 6.3.5 as follows:

"6.3.4 Marking

NOTE 1: The marking indicates that the packaging which bears it corresponds to a successfully tested design type and that it complies with the requirements of this Chapter which are related to the manufacture, but not to the use, of the packaging.

2: The marking is intended to be of assistance to packaging manufacturers, reconditioners, packaging users, carriers and regulatory authorities.

- 3: The marking does not always provide full details of the test levels, etc., and these may need to be taken further into account, e.g. by reference to a test certificate, to test reports or to a register of successfully tested packagings.

6.3.4.1 Each packaging intended for use according to RID shall bear markings which are durable, legible and placed in a location and of such a size relative to the packaging as to be readily visible. For packages with a gross mass of more than 30 kg, the markings or a duplicate thereof shall appear on the top or on a side of the packaging. Letters, numerals and symbols shall be at least 12 mm high, except for packagings of 30 litres or 30 kg capacity or less, when they shall be at least 6 mm in height and for packagings of 5 litres or 5 kg or less when they shall be of an appropriate size.

6.3.4.2 (Text of existing 6.3.1.1, with the following modifications:)

At the beginning, replace "6.3.2" with:

"6.3.5".

In (a), add at the end:

"This symbol shall not be used for any purpose other than certifying that a packaging complies with the relevant requirements in Chapter 6.1, 6.2, 6.3, 6.5 or 6.6;".

In (g), replace "6.3.2.9" with:

"6.3.5.1.6".

At the end, delete the text after sub-paragraphs (a) to (g).

6.3.4.3 Marking shall be applied in the sequence shown in 6.3.4.2 (a) to (g); each element of the marking required in these sub-paragraphs shall be clearly separated, e.g. by a slash or space, so as to be easily identifiable. For examples, see 6.3.4.4.

Any additional markings authorized by a competent authority shall still enable the parts of the mark to be correctly identified with reference to 6.3.4.1.

6.3.4.4 (Text of existing 6.3.1.2, with the following modifications:)

In the marking, replace "01" with:

"06".

Replace "6.3.1.1" with:

"6.3.4.2" (twice).

Replace "(e)," with:

"(e) and".

6.3.5 (Heading of existing 6.3.2)

6.3.5.1 Performance and frequency of tests

6.3.5.1.1 The design type of each packaging shall be tested as provided in this section in accordance with procedures established by the competent authority allowing the allocation of the mark and shall be approved by this competent authority.

6.3.5.1.2 Each packaging design type shall successfully pass the tests prescribed in this Chapter before being used. A packaging design type is defined by the design, size, material and thickness, manner of construction and packing, but may include various surface treatments. It also includes packagings which differ from the design type only in their lesser design height.

6.3.5.1.3 Tests shall be repeated on production samples at intervals established by the competent authority.

6.3.5.1.4 Tests shall also be repeated after each modification which alters the design, material or manner of construction of a packaging.

6.3.5.1.5 (Text of existing 6.3.2.7, with the following modifications:)

Replace "of inner packagings or inner packagings of lower net mass" with:

"or lower net mass of primary receptacles".

Delete:

", bags".

6.3.5.1.6 (Text of existing 6.3.2.9, with the following modifications:)

At the beginning, replace:

– "Inner" with:

"Primary",

– "intermediate (secondary)" with:

"secondary",

– "outer" with:

"rigid outer".

In (a), replace:

– "intermediate/outer packaging combination" with:

"rigid outer packaging",

– "6.3.2.3" with:

"6.3.5.2.2",

- "inner" with:
"primary".

In (b), replace:

- "inner" with:
"primary" (twice).

In (c), replace:

- "inner" with:
"primary" (seven times),
- "intermediate" with:
"secondary" (twice).

Add "spaces" at the end.

In (d), replace:

- "outer" with:
"rigid outer",
- "inner receptacles" with:
"packagings".

In (e), replace:

- "inner" with:
"primary" (twice).

In (f), replace:

- "outer" with:
"rigid outer",
- "inner" with:
"primary" (twice).

Add the following paragraph (g) to read as follows:

"(g) In addition to the markings prescribed in 6.3.4.2 (a) to (f), packagings shall be marked in accordance with 6.3.4.2 (g)."

6.3.5.1.7

The competent authority may at any time require proof, by tests in accordance with this section, that serially-produced packagings meet the requirements of the design type tests.

6.3.5.1.8 Provided the validity of the test results is not affected and with the approval of the competent authority, several tests may be made on one sample.

6.3.5.2 Preparation of packagings for testing

6.3.5.2.1 (Text of existing 6.3.2.2, with the following modifications:)

Replace "98% capacity" with

"not less than 98 % of its capacity".

Add a new note at the end to read as follows:

"NOTE: The term water includes water/antifreeze solution with a minimum specific gravity of 0.95 for testing at –18 °C."

6.3.5.2.2 Tests and number of samples required

Tests required for packaging types

Type of packaging ^(a)		Tests required						
Rigid outer packaging	Primary receptacle		Water spray 6.3.5.3.6.1	Cold conditioning 6.3.5.3.6.2	Drop 6.3.5.3	Additional drop 6.3.5.3.6.3	Puncture 6.3.5.4	Stack 6.1.5.6
	Plastics	Other	No. of samples	No. of samples	No. of samples	No. of samples	No. of samples	No. of samples
Fibreboard box	X		5	5	10	Required on one sample when the packaging is intended to contain dry ice.	2	Required on three samples when testing a "U"-marked packaging as defined in 6.3.5.1.6 for specific provisions.
		X	5	0	5		2	
Fibreboard drum	X		3	3	6		2	
		X	3	0	3		2	
Plastics box	X		0	5	5		2	
		X	0	5	5		2	
Plastics drum/jerrican	X		0	3	3		2	
		X	0	3	3		2	
Boxes of other material	X		0	5	5		2	
		X	0	0	5		2	
Drums/ jerricans of other material	X		0	3	3	2		
		X	0	0	3	2		

^(a) "Type of packaging" categorizes packagings for test purposes according to the kind of packaging and its material characteristics.

NOTE 1: In instances where a primary receptacle is made of two or more materials, the material most liable to damage determines the appropriate test.

2: The material of the secondary packagings are not taken into consideration when selecting the test or conditioning for the test.

Explanation for use of the Table:

If the packaging to be tested consists of a fibreboard outer box with a plastics primary receptacle, five samples must undergo the water spray test (see 6.3.5.3.6.1) prior to dropping and another five must be conditioned to –18 °C (see 6.3.5.3.6.2) prior to dropping. If the packaging is to contain dry ice then one further single sample shall be dropped five times after conditioning in accordance with 6.3.5.3.6.3.

Packagings prepared as for carriage shall be subjected to the tests in 6.3.5.3 and 6.3.5.4. For outer packagings, the headings in the Table relate to fibreboard or similar materials whose performance may be rapidly affected by moisture; plastics which may embrittle at low temperature; and other materials such as metal whose performance is not affected by moisture or temperature.

6.3.5.3 Drop test

6.3.5.3.1 Samples shall be subjected to free-fall drops from a height of 9 m onto a non-resilient, horizontal, flat, massive and rigid surface in conformity with 6.1.5.3.4.

6.3.5.3.2 Where the samples are in the shape of a box; five shall be dropped one in each of the following orientations:

- (a) flat on the base;
- (b) flat on the top;
- (c) flat on the longest side;
- (d) flat on the shortest side;
- (e) on a corner.

6.3.5.3.3 Where the samples are in the shape of a drum, three shall be dropped one in each of the following orientations:

- (a) diagonally on the top chime, with the centre of gravity directly above the point of impact;
- (b) diagonally on the base chime;
- (c) flat on the side.

6.3.5.3.4 While the sample shall be released in the required orientation, it is accepted that for aerodynamic reasons the impact may not take place in that orientation.

6.3.5.3.5 Following the appropriate drop sequence, there shall be no leakage from the primary receptacle(s) which shall remain protected by cushioning/absorbent material in the secondary packaging.

6.3.5.3.6 Special preparation of test sample for the drop test

6.3.5.3.6.1 Fibreboard – Water spray test

Fibreboard outer packagings: The sample shall be subjected to a water spray that simulates exposure to rainfall of approximately 5 cm per hour for at least one hour. It shall then be subjected to the test described in 6.3.5.3.1.

6.3.5.3.6.2 Plastics material – Cold conditioning

Plastics primary receptacles or outer packagings: The temperature of the test sample and its contents shall be reduced to $-18\text{ }^{\circ}\text{C}$ or lower for a period of at least 24 hours and within 15 minutes of removal from that atmosphere the test sample shall be subjected to the test described in 6.3.5.3.1. Where the sample contains dry ice, the conditioning period shall be reduced to 4 hours.

6.3.5.3.6.3 Packagings intended to contain dry ice – Additional drop test

Where the packaging is intended to contain dry ice, a test additional to that specified in 6.3.5.3.1 and, when appropriate, in 6.3.5.3.6.1 or 6.3.5.3.6.2 shall be carried out. One sample shall be stored so that all the dry ice dissipates and then that sample shall be dropped in one of the orientations described in 6.3.5.3.2 which shall be that most likely to result in failure of the packaging.

6.3.5.4 **Puncture test**

6.3.5.4.1 Packagings with a gross mass of 7 kg or less

(Text of existing 6.3.2.6 (a), with the following modification:)

Replace "not exceeding 38 mm" with:

"of 38 mm".

6.3.5.4.2 Packagings with a gross mass exceeding 7 kg

(Text of existing 6.3.2.6 (b), with the following modifications:)

In the fourth sentence, replace "the primary receptacle(s) and the outer surface" with:

"the centre of the primary receptacle(s) and the outer surface".

In the fifth sentence before "in a vertical free fall", insert:

"with its top face lowermost".

In the last but one sentence, replace "the steel rod would penetrate" with:

"the steel rod would be capable of penetrating".

In the last sentence, replace "there shall be no leakage" with:

"penetration of the secondary packaging is acceptable provided that there is no leakage".

6.3.5.5 (Heading of existing 6.3.3)

6.3.5.5.1 (Text of existing 6.3.3.1, with the following modifications:)

At the beginning before "test report", insert:

"written".

In the 4th indent, replace "the test report" with

"the test and of the report".

Amend the 8th indent to read as follows:

"8. Test contents;".

6.3.5.5.2 (Text of existing 6.3.3.2)"

Chapter 6.4

6.4.5.4.1 (b) Amend to read as follows:

"(b) They are designed to satisfy the requirements prescribed for packing group I or II in Chapter 6.1; and".

6.4.5.4.2 At the beginning, delete:

"Tank-containers and".

Amend paragraph (b) to read as follows:

"(b) They are designed to satisfy the requirements prescribed in Chapter 6.7 and are capable of withstanding a test pressure of 265 kPa; and".

At the end of paragraph (c), delete:

"or tank containers".

6.4.5.4.3 Delete:

"and tank-containers".

Replace "that they conform to standards at least equivalent to those prescribed in 6.4.5.4.2." with:

"that:

(a) They satisfy the requirements of 6.4.5.1;

(b) They are designed to satisfy the requirements prescribed in Chapter 6.8; and

(c) They are designed so that any additional shielding which is provided shall be capable of withstanding the static and dynamic stresses resulting from handling and routine conditions of carriage and of preventing an increase of more than 20% in the maximum radiation level at any external surface of the tanks."

6.4.5.4.4 In the first sentence after "containers", insert:

"of a permanent enclosed character".

6.4.5.4.5 (b) Amend the text before (i) and (ii) to read as follows:

"(b) They are designed to satisfy the requirements prescribed in Chapter 6.5 for packing group I or II, and if they were subjected to the tests prescribed in that Chapter, but with the drop test conducted in the most damaging orientation, they would prevent:".

6.4.8.8 Replace "2.2.7.7.2.4 to 2.2.7.7.2.6" with:

"2.2.7.2.2.4 to 2.2.7.2.2.6".

[Consequential amendment]

- 6.4.8.14** Amend to read as follows:
- "6.4.8.14** A package containing low dispersible radioactive material shall be so designed that any features added to the low dispersible radioactive material that are not part of it, or any internal components of the packaging shall not adversely affect the performance of the low dispersible radioactive material."
 [Ref. doc.: INF.18 JM 09/07]
- 6.4.10.3** Replace "2.2.7.7.2.4 to 2.2.7.7.2.6" with:
 "2.2.7.2.2.4 to 2.2.7.2.2.6".
 [Consequential amendment]
- 6.4.11.2** In the first sentence, replace "of this paragraph" with:
 "of 2.2.7.2.3.5".
 Delete sub-paragraphs (a) to (d) and Table 6.4.11.2.
- 6.4.11.11** and
6.4.11.12 Replace "'N" shall be sub-critical" with:
 "'N" packages shall be subcritical".
 [Ref. doc.: INF.34 JM 09/07]
 Add a new sub-section to read as follows:
- "6.4.11.13** The criticality safety index (CSI) for packages containing fissile material shall be obtained by dividing the number 50 by the smaller of the two values of N derived in 6.4.11.11 and 6.4.11.12 (i.e. $CSI = 50/N$). The value of the criticality safety index may be zero, provided that an unlimited number of packages is subcritical (i.e. N is effectively equal to infinity in both cases)."
- 6.4.12.1** Replace "2.2.7.3.3, 2.2.7.3.4, 2.2.7.4.1, 2.2.7.4.2" with:
 "2.2.7.2.3.1.3, 2.2.7.2.3.1.4, 2.2.7.2.3.3.1, 2.2.7.2.3.3.2, 2.2.7.2.3.4.1, 2.2.7.2.3.4.2".
 [Consequential amendment; Ref. doc.: INF.18 JM 09/07]
 In paragraph (a) after "or special form radioactive material,", insert:
 "or low dispersible radioactive material".
 [Ref. doc.: INF.18 JM 09/07]
- 6.4.12.2** Replace "2.2.7.3.3, 2.2.7.3.4, 2.2.7.4.1, 2.2.7.4.2" with:
 "2.2.7.2.3.1.3, 2.2.7.2.3.1.4, 2.2.7.2.3.3.1, 2.2.7.2.3.3.2, 2.2.7.2.3.4.1, 2.2.7.2.3.4.2".
 [Consequential amendment; Ref. doc.: INF.18 JM 09/07]
- 6.4.14** Replace "2.2.7.4.5 (a)" with:
 "2.2.7.2.3.3.5 (a)".

[Consequential amendment]

**6.4.22.2 and
6.4.22.3**

Replace "5.1.5.3.1" with:

"5.1.5.2.1".

[Consequential amendment in relation with the deletion of 5.1.5.1]

6.4.23.2 (c)

Replace "5.1.5.3.1" with:

"5.1.5.2.1".

[Consequential amendment in relation with the deletion of 5.1.5.1]

6.4.23.14

In paragraph (h), replace "5.1.5.2.2" with:

"5.1.5.1.2".

[Consequential amendment in relation with the deletion of 5.1.5.1]

In paragraph (o) before "6.4.8.5", insert:

"6.4.8.4,".

6.4.23.15

Add at the end:

"under 6.4.22.2, 6.4.22.3, 6.4.22.4, 6.4.24.2 and 6.4.24.3".

Chapter 6.5

6.5.2.1.1 (a)

Insert a new sentence after the symbol to read as follows:

"This symbol shall not be used for any purpose other than certifying that a packaging complies with the relevant requirements in Chapter 6.1, 6.2, 6.3, 6.5 or 6.6."

6.5.2.2.1

Add the following new entry to the Table and the following new note b after the Table:

Additional marking	Category of IBC				
	Metal	Rigid Plas- tics	Composite	Fibre- board	Wooden
Maximum permitted stacking load ^(b)	x	x	x	x	x

"^(b) See 6.5.2.2.2. This additional marking shall apply to all IBCs manufactured, repaired or remanufactured as from 1 January 2011 (see also 1.6.1.15)."

Add a new 6.5.2.2.2 to read as follows:

- "6.5.2.2.2** The maximum permitted stacking load applicable when the IBC is in use shall be displayed on a symbol as follows:

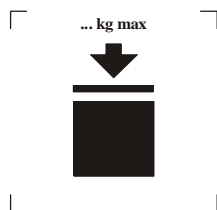

IBCs capable of being stacked

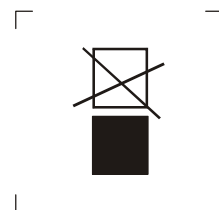

IBCs NOT capable of being stacked

The symbol shall be not less than 100 mm × 100 mm, be durable and clearly visible. The letters and numbers indicating the mass shall be at least 12 mm high.

The mass marked above the symbol shall not exceed the load imposed during the design type test (see 6.5.6.6.4) divided by 1.8.

NOTE: The provisions of 6.5.2.2.2 shall apply to all IBCs manufactured, repaired or remanufactured as from 1 January 2011 (see also 1.6.1.15)."

Current **6.5.2.2.2** to **6.5.2.2.4** become **6.5.2.2.3** to **6.5.2.2.5**. [no other consequential amendments]

- 6.5.4.1** At the end, add a new note to read as follows:

"NOTE: ISO 16106:2006 "Packaging – Transport packages for dangerous goods – Dangerous goods packagings, intermediate bulk containers (IBCs) and large packagings – Guidelines for the application of ISO 9001" provides acceptable guidance on procedures which may be followed."

- 6.5.4.4.2** In the first sentence after "a suitable leakproofness test", add:

"at least equally effective as the test prescribed in 6.5.6.7.3".

After the paragraphs (a) and (b), replace "For this test the IBC need not have its closures fitted." with:

"For this test the IBC shall be fitted with the primary bottom closure."

- 6.5.4.5.5** Renumber as **6.5.4.4.4**.

[Ref. doc.: INF.34 JM 09/07]

- 6.5.5.4.6** Delete the Note.

[Consequential amendment in relation with the definition of "Composite IBC with plastics inner receptacle"]

- 6.5.6.1.1** Replace the first sentence with:

"Each IBC design type shall successfully pass the tests prescribed in this Chapter before being used and being approved by the competent authority allowing the allocation of the mark."

6.5.6.2.1 Replace "6.5.6.12" with:

"6.5.6.13".

[Consequential amendment]

6.5.6.2.4 Replace "6.5.6.13" with:

"6.5.6.14".

[Consequential amendment]

6.5.6.3.7 Amend the Table to read as follows:

Type of IBC	Bottom lift	Top lift ^(a)	Stacking ^(b)	Leak-proofness	Hydraulic pressure	Drop	Tear	Topple	Righting ^(c)	Type of IBC
Metal: 11A, 11B, 11N	–	1st ^(a)	2nd	3rd	–	–	4th ^(e)	–	–	–
21A, 21B, 21N	–	1st ^(a)	2nd	3rd	4th	5th	6th ^(e)	–	–	–
31A, 31B, 31N	1st	2nd ^(a)	3rd	4th	5th	6th	7th ^(e)	–	–	–
Flexible ^(d)	–	–	x ^(c)	x	–	–	x	x	x	x
rigid plastics :										
11H1, 11H2	–	1st ^(a)	2nd	3rd	–	–	4th	–	–	–
21H1, 21H2	–	1st ^(a)	2nd	3rd	4th	5th	6th	–	–	–
31H1, 31H2	1st	2nd ^(a)	3rd	4th ^(g)	5th	6th	7th	–	–	–
Composite: 11HZ1, 11HZ2	–	1st ^(a)	2nd	3rd	–	–	4th ^(e)	–	–	–
21HZ1, 21HZ2	–	1st ^(a)	2nd	3rd	4th	5th	6th ^(e)	–	–	–
31HZ1, 31HZ2	1st	2nd ^(a)	3rd	4th ^(g)	5th	6th	7th ^(e)	–	–	–
Fibre-board	–	1st	–	2nd	–	–	3rd	–	–	–
Wooden	–	1st	–	2nd	–	–	3rd	–	–	–

Insert a new note (f) after the Table to read as follows:

"^(f) Another IBC of the same design may be used for the vibration test."

Rename existing note "f" as "g".

6.5.6.5.5 (a) Amend to read as follows:

"(a) Metal, rigid plastics and composite IBCs: the IBC remains safe for normal conditions of carriage, there is no observable permanent deformation of the IBC, including the base pallet, if any, and no loss of contents;"

6.5.6.7.3 Delete the last sentence.

6.5.6.9.3 Amend the first sentence to read as follows:

"The IBC shall be dropped on its base onto a non-resilient, horizontal, flat, massive and rigid surface in conformity with the requirements of 6.1.5.3.4, in such a manner as to ensure that the point of impact is that part of the base of the IBC considered to be the most vulnerable."

6.5.6.9.5 Add a new paragraph (d) to read as follows:

"(d) All IBCs: no damage which renders the IBC unsafe to be carried for salvage or for disposal, and no loss of contents. In addition, the IBC shall be capable of being lifted by an appropriate means until clear of the floor for five minutes."

6.5.6.13,
6.5.6.13.1 and
6.5.6.13.2 become **6.5.6.14, 6.5.6.14.1** and **6.5.6.14.2.**

[Consequential amendments see under Table of Contents and 6.5.6.2.1 and 6.5.6.2.4]

Insert a new 6.5.6.13 to read as follows:

"6.5.6.13 Vibration test

6.5.6.13.1 Applicability

For all IBCs used for liquids, as a design type test.

NOTE: This test applies to design types for IBCs manufactured after 31 December 2010 (see also 1.6.1.14).

6.5.6.13.2 Preparation of the IBC for test

A sample IBC shall be selected at random and shall be fitted and closed as for carriage. The IBC shall be filled with water to not less than 98% of its maximum capacity.

6.5.6.13.3 Test method and duration

6.5.6.13.3.1 The IBC shall be placed in the center of the test machine platform with a vertical sinusoidal, double amplitude (peak-to peak displacement) of 25 mm ± 5%. If necessary, restraining devices shall be attached to the platform to prevent the specimen from moving horizontally off the platform without restricting vertical movement.

6.5.6.13.3.2 The test shall be conducted for one hour at a frequency that causes part of the base of the IBC to be momentarily raised from the vibrating platform for part of each cycle to such a degree that a metal shim can be completely inserted intermittently at, at least, one point between the base of the IBC and the test platform. The frequency may need to be adjusted after the initial set point to prevent the packaging from going into resonance. Nevertheless, the test frequency shall continue to allow placement of the metal shim under the IBC as described in this paragraph. The continuing ability to insert the metal shim is essential to passing the test. The metal shim used for this test shall be at least 1.6 mm thick, 50 mm wide, and be of sufficient

length to be inserted between the IBC and the test platform a minimum of 100 mm to perform the test.

6.5.6.13.4 Criteria for passing the test

No leakage or rupture shall be observed. In addition, no breakage or failure of structural components, such as broken welds or failed fastenings, shall be observed."

Chapter 6.6

6.6.1.2 At the end, add a new note to read as follows:

"NOTE: ISO 16106:2006 "Packaging – Transport packages for dangerous goods – Dangerous goods packagings, intermediate bulk containers (IBCs) and large packagings – Guidelines for the application of ISO 9001" provides acceptable guidance on procedures which may be followed."

6.6.3.1 (a) Insert a new sentence after the symbol to read as follows:

"This symbol shall not be used for any purpose other than certifying that a packaging complies with the relevant requirements in Chapter 6.1, 6.2, 6.3, 6.5 or 6.6."

6.6.5.1.1 Replace "and approved by the competent authority" with:

"by the competent authority allowing the allocation of the mark and shall be approved by this competent authority".

6.6.5.1.2 Replace the first sentence with:

"Each large packaging design type shall successfully pass the tests prescribed in this Chapter before being used."

6.6.5.3.4.3 Amend the text after the heading to read as follows:

"The large packaging shall be dropped onto a non resilient, horizontal, flat, massive and rigid surface in conformity with the requirements of 6.1.5.3.4, in such a manner as to ensure that the point of impact is that part of the base of the large packaging considered to be the most vulnerable."

Chapter 6.7

**6.7.2.1,
6.7.3.1 and
6.7.4.1**

In the definition of "*Portable tank*", last but one sentence, replace "transport vehicle or ship" with:

"vehicle, wagon or sea-going or inland navigation vessel".

[Ref. doc.: INF.34 JM 09/07]

6.7.4.14.4 In the last sentence after "periodic inspection", insert:

"and tests".

6.7.4.14.5 Amend to read as follows:

"6.7.4.14.5 (Deleted)".

6.7.5.2.1 In the last sentence, replace "transport unit or ship" with:
"vehicle, wagon or sea-going or inland navigation vessel".

6.7.5.2.3 Replace "6.2.5" with:
"6.2.1 and 6.2.2".

[Ref. doc.: INF.32 JM 03/07]

6.7.5.2.9 Replace "6.2.5.2" with:
"6.2.2.1".

[Ref. doc.: INF.32 JM 03/07]

Replace "(see 6.2.3)" with:
"(see 6.2.5)".

[Ref. doc.: INF.32 JM 03/07]

6.7.5.3.2 In the last sentence, replace "isolated by a valve into assemblies of not more than 3 000 litres" with:
"divided into groups of not more than 3 000 litres each isolated by a valve".

6.7.5.4.1 Replace "shall be isolated by a valve into assemblies of not more than 3 000 litres. Each assembly shall be fitted" with:
"divided into groups of not more than 3 000 litres each isolated by a valve. Each group shall be fitted".

Chapter 6.8

6.8.2.1.4 Amend the beginning to read as follows:

"Shells shall be designed and constructed in accordance with the requirements of standards listed in 6.8.2.6 or of a technical code recognized by the competent authority, in accordance with 6.8.2.7, in which the material ...".

[Ref. doc.: ECE/TRANS/WP.15/AC.1/2007/10 + INF.49 JM 03/07]

6.8.2.1.23 Amend the text for " $\lambda = 0.8$ " to read as follows:

" $\lambda = 0.8$: the weld beads shall so far as possible be inspected visually on both faces and shall be subjected to a non-destructive spot check. All weld "Tee" junctions with the total length of weld examined to be not less than 10% of the sum of the length of all longitudinal, circumferential and radial (in the tank ends) welds shall be tested."

[Ref. doc.: TRANS/WP.15/AC.1/2006/10 + INF.38 JM 03/06]

6.8.2.2.1 Insert a new paragraph after "the requirements of 6.8.2.1.1" to read as follows:

"Piping shall be designed, constructed and installed so as to avoid the risk of damage due to thermal expansion and contraction, mechanical shock and vibration."

[Ref. doc.: INF.37 JM 09/06]

6.8.2.4.2 Amend to read as follows:

"6.8.2.4.2 Shells and their equipment shall undergo periodic inspections no later than every eight years | five years.

These periodic inspections shall include:

- an external and internal examination;
- a leakproofness test in accordance with 6.8.2.4.3 of the shell with its equipment and check of the satisfactory operation of all the equipment;
- as a general rule, a hydraulic pressure test⁹ (for the test pressure for the shells and compartments if applicable, see 6.8.2.4.1).

Sheathing for thermal or other insulation shall be removed only to the extent required for reliable appraisal of the characteristics of the shell.

In the case of tanks intended for the carriage of powdery or granular substances, and with the agreement of the expert approved by the competent authority, the periodic hydraulic pressure test may be omitted and replaced by leakproofness tests in accordance with 6.8.2.4.3, at an effective internal pressure at least equal to the maximum working pressure."

[Ref. doc.: TRANS/WP.15/AC.1/2006/6 + INF.21 JM 03/06 + INF.38 JM 03/06 + INF.37 JM 09/06]

6.8.2.4.3 Amend to read as follows:

"6.8.2.4.3 Shells and their equipment shall undergo intermediate inspections at least every four years | two and a half years after the initial inspection and each periodic inspection. These intermediate inspections may be performed within three months before or after the specified date.

However, the intermediate inspection may be performed at any time before the specified date.

If an intermediate inspection is performed more than three months before the due date, another intermediate inspection shall be performed at the latest four years | two and a half years after this date.

These intermediate inspections shall include a leakproofness test of the shell with its equipment and check of the satisfactory operation of all the equipment. For this purpose the tank shall be subjected to an effective internal pressure at least equal to the maximum working pressure. For tanks intended for the carriage of liquids or solids in the granular or powdery state, when a gas is used for the leakproofness test it shall be carried out at a pressure at least equal to 25% of the maximum working pressure. In all cases, it shall not be less than 20 kPa (0.2 bar) (gauge pressure).

For tanks equipped with venting systems and a safety device to prevent the contents spilling out if the tank overturns, the pressure test shall be equal to the static pressure of the filling substance.

The leakproofness test shall be carried out separately on each compartment of compartmented shells."

[Ref. doc.: TRANS/WP.15/AC.1/2006/6 + INF.21 JM 03/06 + INF.38 JM 03/06 + INF.37 JM 09/06]

6.8.2.4.4 Add at the end:

"If an exceptional check fulfilling the requirements of 6.8.2.4.2 has been performed, then the exceptional check may be considered to be a periodic inspection. If an exceptional check fulfilling the requirements of 6.8.2.4.3 has been performed then the exceptional check may be considered to be an intermediate inspection."

[Ref. doc.: INF.37 JM 09/06]

6.8.2.4.5 In the second sentence, after "of these operations", insert:

", even in the case of negative results".

[Ref. doc.: ECE/TRANS/WP.15/AC.1/2007/37 + INF.52 JM 09/07]

In the third sentence, after "tank code", insert:

"and the alphanumeric codes of special provisions".

[Ref. doc.: TRANS/WP.15/AC.1/2006/17 + INF.37 JM 09/06]

6.8.2.5.1 Amend the seventh indent to read as follows:

"– capacity of the shell¹² – in the case of multiple-compartment shells, the capacity of each compartment¹² –, followed by the symbol "S" when the shells or the compartments are divided by surge plates into sections of not more than 7 500 litres capacity;"

[Ref. doc.: ECE/TRANS/WP.15/AC.1/2007/29 + INF.52 JM 09/07]

In the ninth indent, delete the note.

[Ref. doc.: INF.21 JM 03/06 + INF.38 JM 03/06]

6.8.2.6 Amend to read as follows:

"6.8.2.6 Requirements for tanks which are designed, constructed and tested according to standards

NOTE: Persons or bodies identified in standards as having responsibilities in accordance with RID shall meet the requirements of RID.

Depending on the date of construction of the tank, the standards listed in the Table below shall be applied as indicated in column (4) to meet the requirements of Chapter 6.8 referred to in column (1) or may be applied as indicated in column (5). The requirements of Chapter 6.8 referred to in column (1) shall prevail in all cases.

If more than one standard is listed as mandatory for the application of the same requirements, only one of them shall be applied, but in full unless otherwise specified in the Table below.

Applicable sub-sections and paragraphs	Reference	Title of document	Mandatory application for tanks constructed	Application authorized for tanks constructed
(1)	(2)	(3)	(4)	(5)
für alle Tanks				
6.8.2.1	EN 14025:2003	Tanks for the transport of dangerous goods – Metallic pressure tanks – Design and construction	Between 1 January 2009 and 31 December 2010	Between 1 January 2005 and 31 December 2008
[6.8.2.1	EN 14025:2008	Tanks for the transport of dangerous goods – Metallic pressure tanks – Design and construction	As from 1 January 2011	Before 1 January 2011]
6.8.2.2.1	EN 14432:2006	Tanks for the transport of dangerous goods – Tank equipment for the transport of liquid chemicals – Product discharge and air inlet valves	As from 1 January 2011	Before 1 January 2011
6.8.2.2.1	EN 14433:2006	Tanks for transport of dangerous goods – Tank equipment for the transport of liquid chemicals – Foot valves	As from 1 January 2011	Before 1 January 2011
For testing and inspection				
6.8.2.4 6.8.3.4	EN 12972:2001 (with the exception of annexes D and E)	Tanks for transport of dangerous goods – Testing, inspection and marking of metallic tanks	Between 1 January 2009 and 31 December 2010 ¹¹	Between 1 January 2003 and 31 December 2008
6.8.2.4 6.8.3.4	EN 12972:2007	Tanks for transport of dangerous goods – Testing, inspection and marking of metallic tanks	As from 1 January 2011	Before 1 January 2011
For tanks with a maximum working pressure not exceeding 50 kPa and intended for the carriage of substances for which a tank code with the letter "G" is given in column (12) of Table A of Chapter 3.2				
6.8.2.1	EN 13094:2004	Tanks for the transport of dangerous goods – Metallic tanks with a working pressure not exceeding 0.5 bar – Design and construction	Between 1 January 2009 and 31 December 2010	Between 1 January 2005 and 31 December 2008
[6.8.2.1	EN 13094:2008	Tanks for the transport of dangerous goods – Metallic tanks with a working pressure not exceeding 0.5 bar – Design and construction	As from 1 January 2011	Before 1 January 2011]
For tanks intended for the carriage of liquid petroleum products and other dangerous substances of Class 3 which have a vapour pressure not exceeding 110 kPa at 50 °C and petrol, and which have no toxic or corrosive subsidiary hazard				
6.8.2.1	EN 13094:2004	Tanks for the transport of dangerous goods – Metallic tanks with a working pressure not exceeding 0.5 bar – Design and construction	Between 1 January 2009 and 31 December 2010	Between 1 January 2005 and 31 December 2008
[6.8.2.1	EN 13094:2008	Tanks for the transport of dangerous goods – Metallic tanks with a working pressure not exceeding 0.5 bar – Design and construction	As from 1 January 2011	Before 1 January 2011]

[Ref. doc.: INF.36/Rev.1 JM 09/06 + INF.39 JM 09/06 + ECE/TRANS/WP.15/AC.1/2007/55 + INF.51 JM 09/07]

¹¹ Unless the application of another standard is authorized in column (5) for the same purposes for tanks constructed at the same date.

6.8.2.7 Delete the first and second sub-paragraph.

Amend the third (new first) sub-paragraph to read as follows:

"To reflect scientific and technical progress or where no standard is listed in 6.8.2.6 or to deal with specific aspects not addressed in a standard listed in 6.8.2.6, the competent authority may recognize the use of a technical code providing the same level of safety. Tanks shall, however, comply with the minimum requirements of 6.8.2."

[Ref. doc.: ECE/TRANS/WP.15/AC.1/2007/10 + INF.49 JM 03/07]

6.8.3.1.5 Replace "6.2.3.1" with:

"6.2.5.3".

[Ref. doc.: INF.32 JM 03/07]

6.8.3.2.3 Amend the beginning to read as follows:

"All filling and all discharge openings of tanks ...".

[Ref. doc.: INF.16 JM 03/07 + INF.49 JM 03/07]

At the end, add the following sub-paragraph:

"A non-return valve does not fulfil the provisions of this paragraph."

[Ref. doc.: INF.16 JM 03/07 + INF.49 JM 03/07]

6.8.3.2.11 Add the following new sentence at the end:

"The provisions of 6.8.2.1.7 shall not apply to vacuum-insulated tanks."

[Ref. doc.: ECE/TRANS/WP.15/AC.1/2007/53 + INF.52 JM 09/07]

6.8.3.4.6 Amend to read as follows:

"6.8.3.4.6 By derogation from the requirements of 6.8.2.4, the periodic inspections according to 6.8.2.4.2, shall take place:

(a) at least every three years | at least every two and a half years
in the case of tanks intended for the carriage of UN No.1008 boron trifluoride, UN No. 1017 chlorine, UN No. 1048 hydrogen bromide, anhydrous, UN No. 1050 hydrogen chloride, anhydrous, UN No. 1053 hydrogen sulphide, UN No. 1067 dinitrogen tetroxide (nitrogen dioxide), UN No. 1076 phosgene or UN No. 1079 sulphur dioxide;

(b) at least after six years | at least after 8 years
of service and thereafter at least every 12 years in the case of tanks intended for the carriage of refrigerated liquefied gases.

The intermediate inspections according to 6.8.2.4.3 shall be carried out at least six years after each periodic inspection.	A leakproofness test or an intermediate inspection according to 6.8.2.4.3 may be performed, at the request of the competent authority, between any two successive periodic inspections.
---	---

When the shell, its fittings, piping and items of equipment have been tested separately, the tank shall be subjected to a leakproofness test after assembly."

[Ref. doc.: INF.14 JM 03/06+ INF.21 JM 03/06 + INF.38 JM 03/06]

6.8.3.4.13 Replace "6.2.1.6" with:

"6.2.1.6 and 6.2.3.5 respectively".

[Consequential amendment; Ref. doc.: INF.32 JM 03/07 + INF.21 JM 09/07]

6.8.3.4.16 In the second sentence, after "of these operations", insert:

", even in the case of negative results".

[Ref. doc.: ECE/TRANS/WP.15/AC.1/2007/37 + INF.52 JM 09/07]

6.8.3.5.7 In the left-hand column, add the following new sentence at the end:

"The folding panels shall be designed and be capable of being secured so that they cannot unfold or become loose from the frame during carriage (especially as a result of impacts or unintentional actions)."

[Ref. doc.: OTIF/RID/CE/2006/6 as amended+ OTIF/RID/CE/2006-A]

6.8.3.5.13 Replace "6.2.1.7" with:

"6.2.2.7".

[Ref. doc.: INF.32 JM 03/07]

6.8.4

TE11 Add the following new sentence at the end:

"A safety valve preventing the entry of foreign matter also fulfils this provision."

[Ref. doc.: ECE/TRANS/WP.15/AC.1/2007/33 + INF.16 JM 09/07 + INF.52 JM 09/07]

TE 22 At the end, add:

"The requirements of this paragraph are considered to have been complied with if Section 1.4 of UIC leaflet 573* (Technical conditions for the construction of tank wagons) is applied.

* 6th Edition of the UIC leaflet applicable from 1 April 2005."

[Ref. doc.: OTIF/RID/CE/2006/9]

Insert the following new special provisions:

"TA 4 The conformity assessment procedures of section 1.8.7 shall be applied by the competent authority, its delegate or inspection body conforming to 1.8.6.4 and accredited to EN ISO/IEC 17020:2004 type A."

"TT 9 For inspections and tests (including supervision of the manufacture) the procedures of section 1.8.7 shall be applied by the competent authority, its delegate or inspection body conforming to 1.8.6.4 and accredited according to EN ISO/IEC 17020:2004 type A."

Chapter 6.10

6.10.3.7 (a) Amend to read as follows:

"(a) the boom is fitted with an internal or external stop-valve fixed directly to the shell, or directly to a bend that is welded to the shell; a rotation crown wheel can be fitted between the shell or the bend and the external stop valve, if this rotation crown wheel is located in the protected area and the stop-valve control device is protected with a housing or cover against the danger of being wrenched off by external loads;"

[Ref. doc.: TRANS/WP.15/AC.1/2006/4 + INF.38 JM 03/06]

PART 7

Chapter 7.3

7.3.2.6 In the heading, replace "Wastes" with:

"Goods".

7.3.2.6.1 Replace the text before paragraph (a) with the following:

"Animal material containing infectious substances (UN Nos. 2814, 2900 and 3373) is authorized for carriage in bulk containers provided the following conditions are met:"

At the beginning of paragraph (a), replace "For wastes of UN Nos. 2814 and 2900, sheeted" with:

"Sheeted".

Amend paragraph (c) to read as follows:

"(c) The animal material shall be thoroughly treated with an appropriate disinfectant before loading prior to carriage;"

At the beginning of paragraph (d), replace "Wastes of UN Nos. 2814 and 2900 in a sheeted bulk container" with:

"Sheeted bulk containers".

In (e), delete:

"used for the carriage of wastes of UN Nos. 2814 and 2900".

After paragraph (e), insert the following new note after the indents:

"NOTE: Additional provisions may be required by appropriate national health authorities."

Chapter 7.5

7.5.1.1 Amend the first sub-paragraph to read as follows:

"The requirements in force at the forwarding station shall be complied with for the loading of goods, provided they do not conflict with the requirements of this Chapter."

[Ref. doc.: INF.2 CE 10/06 as amended + OTIF/RID/CE/2006-A]

Delete the second sub-paragraph.

[Ref. doc: OTIF/RID/CE/2006/1 + OTIF/RID/CE/2006-A]

7.5.2.1 In the Table add an "X" in the following rows and columns:

- row "5.2" and column "5.2 + 1";
- row "5.2 + 1" and column "5.2".

[Ref. doc.: TRANS/WP.15/AC.1/2006/16]

In footnote (d) to the Table, replace "and inorganic nitrates of Class 5.1 (UN Nos. 1942 and 2067)" with:

"(UN Nos. 1942 and 2067) and alkali metal nitrates (e.g. UN No. 1486) and alkaline earth metal nitrates (e.g. UN No. 1454)".

[7.5.3 Replace "in the direction of the track" with:

"on the same train".]
